

# Make:

**50+ PROJECTS**

From Woodworking to Wi-Fi

**SPECIAL SECTION: EYE IN THE SKY**

Aerial Videos · First-Person Flight  
Drone Law · 3D Photogrammetry

Now 6 times  
a year!



## **HOMEGROWN DRONES!**

**FUN · PRACTICAL · EASIER THAN EVER**



# Build “Drawdio,” a simple electronic sound synthesizer mounted on a pencil

Designed by Jay Silver, then a student in the Life-long Kindergarten group at the MIT Media Lab, the Drawdio circuit plays a musical tone with a frequency that varies based on the resistance between two points. The wire wrapped around the pencil handle is one point, and the pencil lead itself is another. When you hold Drawdio in your hand, your body becomes part of the resistive loop, and you can do all kinds of fun tricks, like draw yourself a piano and play a little tune!

The Drawdio circuit is based on the classic 555 timer chip. To save space on batteries, we’re using a more modern low-power version of the 555 that will run on 3 volts, but otherwise it behaves just like a standard 555. Wired like this, the 555 operates in so-called *astable mode*, outputting a continuous stream of pulses from pin 3. The frequency of those pulses can be controlled by changing the values of the resistors and capacitors connected to pins 2

and 7. Since the contacts are arranged to put the user’s body into the resistive loop, the frequency output by the 555 naturally varies depending on what she or he is touching. The transistor amplifies those pulses, which emerge from the speaker as audible sound.

—Sean Michael Ragan, MAKE Technical Editor;  
Michael Colombo, MAKE Online Contributor

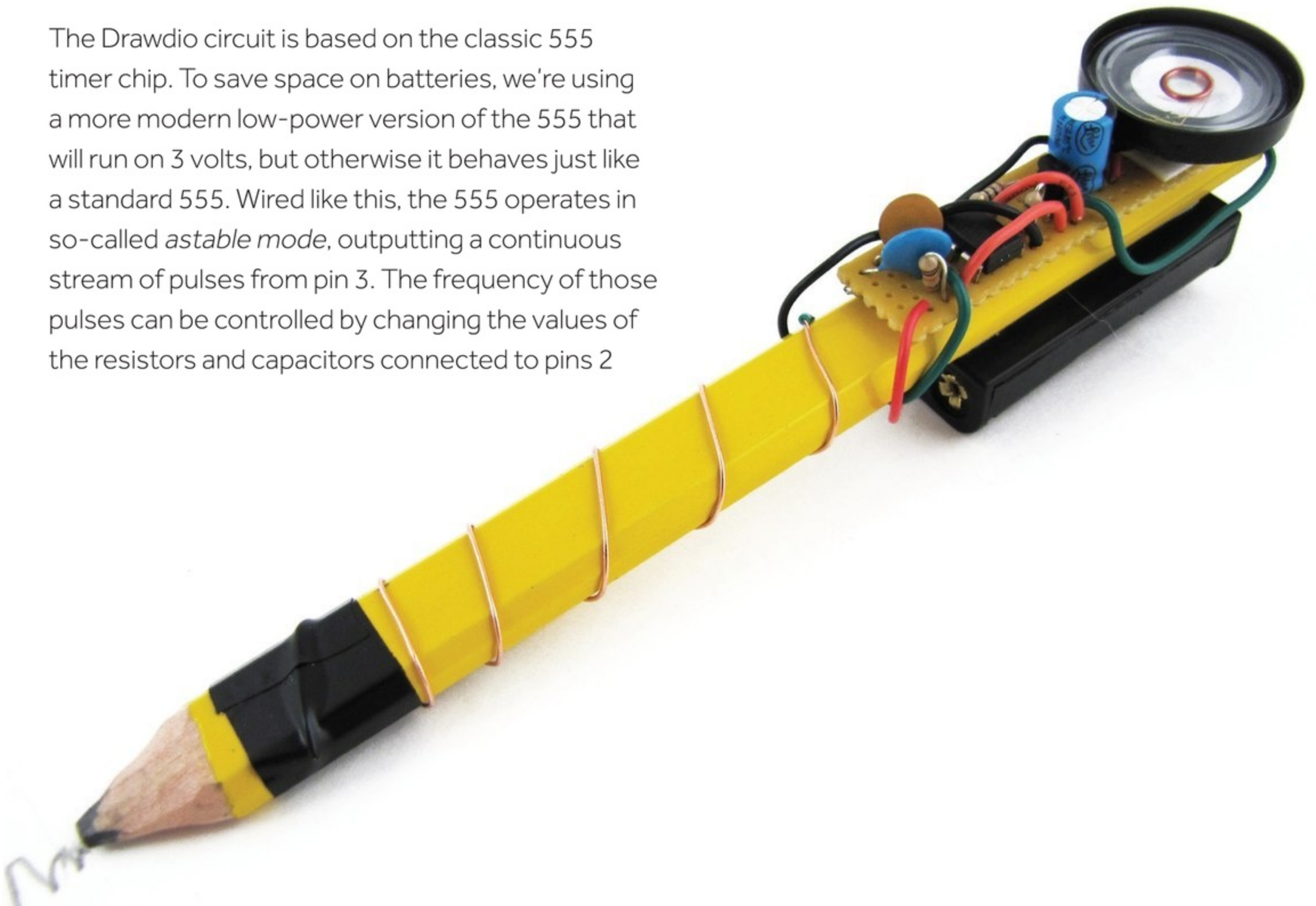



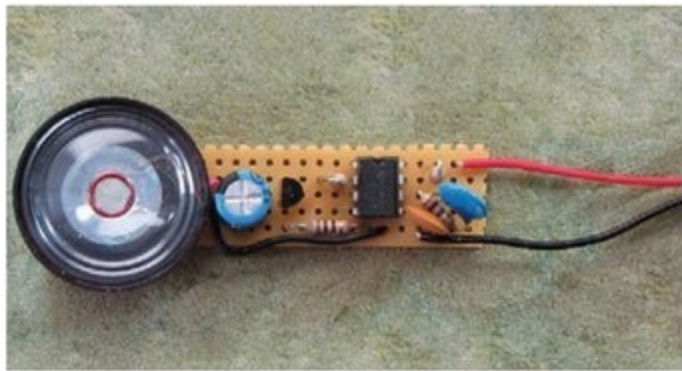

1. Test-fit the components on the perfboard.



2. Cut and strip the grip and graphite leads.



3. Solder the components and attach the speaker to the perfboard.

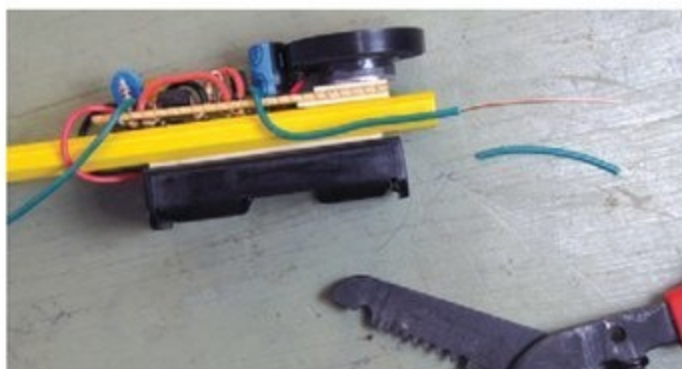

4. Attach the perfboard and battery holder to the pencil.



5. Secure the graphite lead to the top with a thumbtack.



6. Secure the grip lead with electrical tape.

## Learn to build an analog sound synthesizer that piggybacks on top of a pencil!

### Parts list:

- Electrical tape
- Perfboard
- 0.1 $\mu$ F ceramic disk capacitor
- Battery, AAA (2)
- TLC555/TLC555CP LinCMOS timer (8-pin DIP)
- Thumbtack, flat, metal
- PNP amplifying transistor
- Battery holder, 2 x AAA
- Resistors 1/4W - 10M, 270K, 10K, 10  $\Omega$
- 8  $\Omega$  mini speaker
- Double-sided foam tape
- Hookup wire, 22AWG solid
- 100 $\mu$ F 35V 20% radial-lead electrolytic capacitor
- Pencil, flat with soft lead
- 560pF disc capacitor



**TLC555/TLC555CP  
LinCMOS timer  
(8-pin DIP)**



**2 x "AAA" battery  
holder**



**PNP amplifying  
transistor**



**40 watt pencil iron**

### Tools checklist:

- Pliers, mini long-nose
- Wire stripper / cutter
- Soldering iron and solder
- Scissors
- Utility knife
- Straightedge
- Green florist's foam (optional)

For complete instructions and details on this project visit:

[radioshackdiy.com/drawdio](http://radioshackdiy.com/drawdio)



**radioshack**<sup>TM</sup>



# CONTENTS

## COLUMNS

Welcome	06
Reader Input	08
All Art is Made by Makers	10
Hackschooling	11
Made on Earth	12

## FEATURES

Shifting Gears <i>A student-built, world-class race car.</i>	20
Radically Cheap <i>Building machine tools from car parts to save the world.</i>	24
Inkjet Maniac <i>Hacking printers for the sake of art.</i>	28

## DRONES

Flight of the Drones <i>The multicopter revolution is coming. Are you ready?</i>	32
Anatomy of a Drone <i>Find your way around a modern multirotor UAV.</i>	34
Aerial Videography <i>Make fantastic videos from your multicopter or drone.</i>	36
World of Drones <i>Drones are already hard at work, from the pyramids to the polar ice.</i>	40
Quadcopter Photogrammetry <i>R/C aircraft helping restore historic buildings in Cuba.</i>	42
HandyCopter UAV <i>Build a cheap quadrotor airframe with video and autonomous flight.</i>	44
Drone Buyer's Guide <i>Take a peek at the new wave of drones available to buy now.</i>	49
FPV Fundamentals <i>Pilot your drone by seeing what it sees, with first person view.</i>	50
Custom-Crafted Multicopters <i>Homegrown drones — you can build your own!</i>	52
No Man's Land <i>The legal gray area facing drones and their pilots.</i>	53
Quad Squad <i>These expert drone pilots are making quadcopters even cooler.</i>	54

## SKILL BUILDERS

Finding Your Way with GPS <i>Precision location data, via satellite.</i>	58
Calling Out Around the World <i>Communicate with your projects anywhere they can see the sky.</i>	62
Sensor Smörgåsbord <i>All-in-one sensing devices are cheaper &amp; easier to use than ever.</i>	64

## PROJECTS

Luminous Lowtops <i>Snazzy sneakers with full-color LEDs that respond to your moves.</i>	66
Salt and Pepper Well <i>Woodworking with a twist — use your drill press as a lathe.</i>	70
Library Box <i>A mobile, anonymous wi-fi file server from off-the-shelf hardware.</i>	74
Zombie Flashlight <i>Revive a dead battery to make this powerful pocket flashlight.</i>	75
License Plate Guitar <i>A "resonator" guitar with a hand-wound electromagnetic pickup.</i>	76
Remaking History <i>Build the simple plane that defined modern aircraft.</i>	80
Three-Day Kimchi <i>Piquant, fiery, and fast to make.</i>	82



**FLIGHT OF THE DRONES**  
Here's looking at you:  
new platforms for  
aerial imaging.  
**32**



123: Glider Launcher <i>An inexpensive launcher that yields impressive flights.</i>	83
The Amateur Scientist <i>Track heat islands with data loggers and DIY sensors.</i>	84
Chameleon Bag <i>An interactive messenger bag that reacts to your RFID-tagged objects.</i>	86
Toy Inventor's Notebook <i>Stop ants from getting into the hummingbird feeder with a DIY moat.</i>	89
Enough Already <i>Use an Arduino to mute annoying celebrities on your TV automatically.</i>	90
Bass Bump <i>Build this circuit to boost low frequencies and make your MP3s go boom.</i>	92
123: Self-Filling Pet Water Bowl <i>Keep your pet happy and hydrated with this simple build.</i>	93
Bamboo Hors d'Oeuvre Tray <i>A few clever cuts and you'll be serving in style.</i>	94
Mini Blind Minder <i>Train your blinds to automatically open when it's cold and close when it's hot.</i>	95

GPS Cat Tracker <i>Find out exactly where kitty wanders all day.</i>	96
CNC Air Raid Siren <i>It's loud, annoying, and fun!</i>	97
Glow Plug 3D Printer Extruder <i>Make an extruder by hand using only a few tools and a diesel glow plug.</i>	98
Howtoons <i>Build a nifty ripcord rotor copter with an emery board propeller.</i>	99
Homebrew: Pinball Machine <i>One man's journey to build a pinball machine from the ground up.</i>	112

## TOOLBOX

Tool Reviews <i>MAKE's recommendations for useful maker tools and materials.</i>	100
Books <i>Text tools for your bench or bedside table.</i>	104
New Maker Tech <i>On the horizon for 3D printing, Arduino, and Raspberry Pi.</i>	106



# You can't stop innovation...



Available at:  
**amazon.com**



# UP! Create! Innovate!

## Maker Profile: RC Dragster Sports

Ilo Floyd builds high performance frames and drive trains for RC dragster cars with his Tormach PCNC 1100. These dragsters are powered by Lithium batteries and race on a 1/10th scale quarter mile track that is 132 feet long. His record is 1.49 seconds at over 90 miles per hour. Learn more at [www.tormach.com/dragsters](http://www.tormach.com/dragsters).

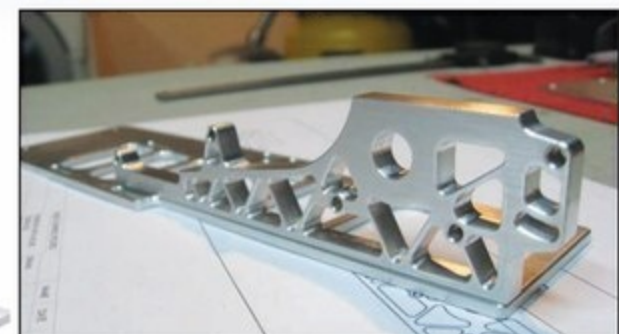
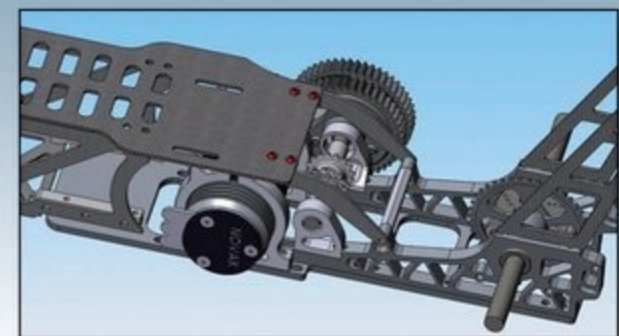

PCNC 770 Series 3  
starting at:  
**\$6850** (plus shipping)



PCNC 1100 Series 3  
starting at:  
**\$8480**  
(plus shipping)



Mills shown here  
with optional stand  
and accessories.



[www.tormach.com/dragsters](http://www.tormach.com/dragsters)



"One finds limits  
by pushing them."  
—Herbert Simon

# Make!

FOUNDER & PUBLISHER  
**Dale Dougherty**  
dale@makezine.com

PRESIDENT & COO  
**Greg Brandeau**  
greg@makezine.com

## CONTRIBUTORS

What fantastic  
contraption would  
you love to build?



**Tom Kuehn**  
Author, *My Own  
Pinball Machine*, p. 112  
My ultimate fantastic  
contraption would be  
to build a house from  
the ground up. The house would  
be powered by renewables, have  
smart adaptive energy control with  
sensors to detect and predict your  
habits, and be centrally controlled  
and web aware. Also there would  
be trap doors, bookcase levers,  
and rotating fireplace doors!



**Skyler Tiffin**  
Author, *Self-Filling Pet  
Water Bowl*, p. 93  
My contraption would  
be called the Pack  
'em Up. It would put  
my homework into my backpack  
at school when I close my locker.  
When I open up my locker again,  
my books would be in my bag and  
I could go home without having to  
pack my stuff up.



**Mikal Hart**  
Author, *Finding Your  
Way with GPS, Use  
the Iridium Satellite  
Network in Your  
Project*, p. 58  
In the late 1970s I was swept into  
the (brief) rolling ball clock fad.  
Ever since, I've been enthralled  
by rolling ball and mechanical  
sculptures. I want to make a big  
timekeeping device that involves  
lots of ping pong balls being blown  
up into, and falling out of, arrays  
of overhead PVC tubes, gated by  
servo-controlled arms.



**Chad Kapper**  
Author, *The  
HandyCopter*, p. 44  
I love blending old  
style tech with new  
ideas. A steam powered  
quadcopter with a vintage  
plate camera would be a fun  
challenge!



**Clayton Richter**  
Author, *Luminous  
Lowtops*, p. 66  
A fantastic contrap-  
tion that I would  
like to make is a pen  
that records what you draw and  
displays it using persistence-of-  
vision if you wave  
it back and forth.



**William Grassie**  
Author, *Quadcopter  
Photogrammetry*, p. 42  
As far back as I  
can remember I  
have always been  
enamored of flight. I would love  
one day to build my own custom-  
designed aircraft.

EDITOR-IN-CHIEF  
**Mark Frauenfelder**  
markf@makezine.com

### EDITORIAL

EXECUTIVE EDITOR  
**Mike Senese**  
msenese@makezine.com

MANAGING EDITOR  
**Cindy Lum**  
clum@makezine.com

PROJECTS EDITOR  
**Keith Hammond**  
khammond@makezine.com

SENIOR EDITOR  
**Goli Mohammadi**  
goli@makezine.com

SENIOR EDITOR  
**Stett Holbrook**  
sholbrook@makezine.com

TECHNICAL EDITOR  
**Sean Michael Ragan**  
sragan@makezine.com

ASSISTANT EDITOR  
**Laura Cochran**

STAFF EDITOR  
**Arwen O'Reilly Griffith**

EDITORIAL ASSISTANT  
**Craig Couden**

COPY EDITOR  
**Laurie Barton**

SENIOR EDITOR, BOOKS  
**Brian Jepson**

EDITOR, BOOKS  
**Patrick DiJusto**

DIGITAL FABRICATION EDITOR  
**Anna Kaziunas France**

CONTRIBUTING EDITORS  
William Gurstelle, Charles Platt,  
Matt Richardson

CONTRIBUTING WRITERS  
Jeffrey Blank, Phil Bowie, Andy  
Brown, Ken Burns, Ryan Calo,  
Alex Carrillo, Eric Cheng, Adam  
Conway, Marque Cornblatt, Larry  
Cotton, Len Cullum, William  
Grassie, Jason Griffey, Saul  
Griffith, Mikal Hart, Gregory  
Hayes, Ross Hershberger, Steve  
Hoefler, Mister Jalopy, Janet Jay,  
Chad Kapper, Adam Kemp, Laura  
Kiniry, Bob Knetzger, Tom Kuehn,  
Tod Kurt, Andrew Petersen,  
Logan LaPlante, Steve Lodefink,  
Kathryn McElroy, Forrest M. Mims  
III, Mike Outmesguine, John Edgar  
Park, Bob Parks, Clayton Richter,  
Polly Robertus, James Rutter,  
Rick Schertle, Jason Short, Paul  
Spinrad, Matt Stultz, Skyler Tiffin,  
Wendy Jehanara Tremayne, Don  
Undeen, Marc de Vinck, Craig  
Wilson, Chester Winowiecki,  
Joseph Zinter

### DESIGN, PHOTOGRAPHY & VIDEO

CREATIVE DIRECTOR  
**Jason Babler**  
jbabler@makezine.com

ART DIRECTOR  
**Juliann Brown**

SENIOR DESIGNER  
**Pete Ivey**

PHOTO EDITOR  
**Jeffrey Braverman**

PHOTOGRAPHER  
**Gunther Kirsch**

VIDEOGRAPHERS  
**Nat Wilson-Heckathorn**  
**Emmanuel Mota**

FABRICATOR  
**Daniel Spangler**

### WEBSITE

DIRECTOR OF WEB  
DEVELOPMENT  
**Parker Thomas**

WEB DEVELOPERS  
**Jake Spurlock**  
jspurlock@makezine.com

**Cole Geissinger**

WEB PRODUCERS  
**Bill Olson**  
**David Beauchamp**

WEB DESIGNER  
**Amy Woods**

CONTRIBUTING ARTISTS  
Nick Dragotta, Andrew Goodman,  
Viktor Koen, Rob Nance, Peter  
O'Toole, Damien Scogin, Peter  
Strain, Julie West

CONTRIBUTING DESIGNERS  
James Burke

ONLINE CONTRIBUTORS  
Alasdair Allan, John Baichtal,  
Meg Allan Cole, Michael Colombo,  
Jimmy DiResta, Nick Normal,  
Haley Pierson-Cox, Andrew  
Salomone, Andrew Terranova,  
Glen Whitney

INTERNS  
Paloma Fautley (enr.), Sam  
Freeman (enr.), Andrew Katz  
(jr. enr.), Brian Melani (enr.),  
Nick Parks (enr.), Eloy Salinas  
(enr.), Wynter Woods (enr.)

VICE PRESIDENT  
**Sherry Huss**  
sherry@makezine.com

### SALES & ADVERTISING

SENIOR SALES MANAGER  
**Katie D. Kunde**  
katie@makezine.com

SALES MANAGER  
**Cecily Benzon**  
cbenzon@makezine.com

SALES MANAGER  
**Brigitte Kunde**  
brigitte@makezine.com

CLIENT SERVICES  
MANAGER  
**Miranda Mager**

CLIENT SERVICES  
MANAGER  
**Mara Lincoln**

EXECUTIVE ASSISTANT  
**Suzanne Huston**

FINANCE CONTROLLER  
**Kevin Gushue**

### COMMERCE

VICE PRESIDENT  
OF COMMERCE  
**David Watta**

DIRECTOR, RETAIL  
MARKETING  
& OPERATIONS  
**Heather Harmon  
Cochran**  
heatherh@makezine.com

MAKER SHED GRAPHIC  
DESIGNER  
**Uyen Cao**

OPERATIONS MANAGER  
**Rob Bullington**

BUSINESS DEVELOPMENT  
MANAGER  
**Heather Brundage**

SENIOR CHANNEL  
MANAGER  
**Ilana Budanitsky**

PRODUCT DEVELOPMENT  
ENGINEER  
**Eric Weinoffer**

PRODUCT INNOVATION  
MANAGER  
**Michael Castor**



Statement of Ownership, Management and Circulation: 1. Publication Title: Make Magazine; 2. Publication Number: 1556-2336; 3. Filing Date: 10/01/13; 4. Issue Frequency: Quarterly; 5. Number of Issues Published Annually: 4; 6. Annual Subscription Price: \$34.95; 7. Complete Mailing Address of Known Office of Publication: Maker Media, 1005 Gravenstein Hwy North, Sebastopol CA 95472; 8. Complete Mailing Address of Headquarters: same; 9. Full Names and Complete Mailing Addresses of Publisher, Editor, and Managing Editor: Publisher: Dale Dougherty, Editor: Mark Frauenfelder, Managing Editor: Cindy Lum, all at Maker Media, 1005 Gravenstein Hwy North, Sebastopol CA 95472; 10. Owner: Maker Media, Inc., 1005 Gravenstein Hwy North, Sebastopol CA 95472; 11. Known Bondholders, Mortgagees, and Other Security Holders Owning or Holding 1 Percent or More of Total Amount of Bonds, Mortgages, or Other Securities: Dale Dougherty, Maker Media, 1005 Gravenstein Hwy North, Sebastopol CA 95472; Tim O'Reilly, Maker Media, 1005 Gravenstein Hwy North, Sebastopol CA 95472; 12. Tax Status: [x] Has Not Changed During Preceding 12 Months; 13. Publication Title: Make Magazine; 14. Issue Date for Circulation Data Below: July 2013 [Vol 35]; 15. Extent and Nature of Circulation, Avg. No. Copies Each Issue During Preceding 12 Months/No. Copies of Single Issue Published Nearest to Filing Date; a. Total Number of Copies [Net Press Run]: 118,178/114,301; b. Paid Circulation [By Mail and Outside the Mail] (1) Mailed Outside-County Paid Subscriptions 62,603/63,124, (2) Mailed in-county Paid Subscriptions 0/0, (3) Paid Distribution Outside the Mails 15,847/15,187, (4) Paid Distribution by other Classes of mail through the USPS 0/0. c. Total Paid Distribution [sum of 15 b, (1), (2), (3), and (4)] 78,450/78,311 d. Free or Nominal Rate Distribution (1) Outside-County Copies 836/872, (2) In-County Copies: 0/0, (3) Mailed at other Classes through the USPS: 0/0, (4) Distribution outside the Mail: 2,731/2,585; e. Total Free or Nominal Rate Distribution [Sum of 15d (1), (2), (3), and (4)]: 3,567/3,457; f. Total Distribution [Sum of 15c and 15e]: 82,017/81,768; g. Copies Not Distributed: 36,161/32,533; h. Total [sum of 15f and g]: 118,178/114,301; j. Percent Paid [15c divided by 15f]: 95.65%/95.77%; 16. Publication of Statement of Ownership: [x] Publication Required. Will be printed in the Feb/Mar 2014 issue of this publication. 17. Signature and Title of Editor, Publisher, Business Manager, or Owner [signed] Heather Cochran, Business Manager, 10/01/13. I certify that all information furnished on this form is true and complete. I understand that anyone who furnishes false or misleading information on this form or who omits material or information requested on the form may be subject to criminal sanctions (including fines and imprisonment) and/or civil sanctions (including civil penalties).



# Spacecraft Studios invites you to launch your own creativity



Allison Merrick's SpaceCraft Studios is a unique blend of a workroom studio space and retail shop with handcrafted gifts and DIY kits. The studio offers classes including sewing, knitting, screen printing, jewelry-making, paper-making, soap-making, glass etching, soldering, metal stamping and many more.

The studio is equipped with the traditional tools and supplies you'd

expect in a crafting space, as well as a digital fabric printer, additive 3D printer and digitizer — and now the Handibot Smart Tool. Allison explained, "I want to learn all I can about the Handibot tool so I can help others integrate it into making." Her husband, Dan Bradley, a software engineer, is fascinated by the possibilities of app development for the Handibot tool.

**"Making things is how we learn and expand our creativity."**

Allison said, "To me, there's a natural connection between making and education. We learn by making. So as I dreamt of having my own company, I saw a need for a place where people can gather and be inspired and make things... I want to help empower people to start making the things in their world themselves and see where it can take them."

Photos by Jeni Rone



**WHERE** Charleston, SC

**BUSINESS** SpaceCraftStudios.com

**SHOPBOT TOOL** Handibot® Smart Power Tool

## What's a Handibot?

The Handibot Smart Tool is a subtractive digital fabrication tool for cutting in woods, plastics, soft metal and more. Unlike "traditional" CNC tools, it's easy to take to any jobsite; you just bring the tool to your work. And it can be run by apps from smartphones or tablets. You can put the Handibot to work with no previous training in CAD or CNC.

The Handibot development team is crowdsourcing app ideas now. Submit yours for a chance to win cool Handi-swig! Visit [handibot.com](http://handibot.com).



ShopBot  
**handibot**®

Handibot® and the Handibot logo are trademarks of ShopBot Tools, Inc.



# Mind Your Drone



**WRITTEN BY**  
**DALE DOUGHERTY,**  
founder and CEO of  
Maker Media.

**Not everybody likes the word drone** — industry and military experts avoid using the “D word” in public. They prefer the term “unmanned aerial system or vehicle” and associated acronyms UAS or UAV. Despite plenty of misgivings about military and spy drones, the word drone has become widespread and popular, used with great enthusiasm by hobbyists who hang out on the DIY Drones site and by professional aerial photographers like the L.A.-based Drone Dudes. So what is a drone?

The original meaning of drone is a male bee. The body of a drone is bigger than all other bees (except the queen), but what physically distinguishes a drone is a larger pair of compound eyes. Yet drones have no real work to do but reproduce. They make late afternoon flights to what is called a congregation area, where drones gather looking to mate with a virgin queen. Once these bees succeed, however (and they perform this act in mid-air), the drones fall out of the sky, having left an essential body part behind. That’s all that drones do.

The notion that a drone doesn’t have much work of its own leads to a secondary definition of a drone as someone who lives off the work of others — a parasite. In fact, at the end of summer, the worker bees kick the remaining drones out of the hive. They eat too much and do too little. They can be replaced in the spring.

This helps set up the problem. We not only need to figure out a definition for drones, we also have to figure out what they’re going to do — and not do. While some agree that drones are unmanned, others point out that they’re piloted, preferring the acronym RPA for “remotely piloted aircraft.” That wouldn’t differentiate drones from remote-control aircraft, but it emphasizes that a human, who can be held responsible, is at the controls. A drone can be operated manually or it can be programmed to follow a fixed flight plan.

The distinguishing feature of a drone seems to be the promise of autonomy. Today, a typical flight consists of switching between manual flight and autopilot. How much further might it go? Given the right instrumentation and the ability to process that data, could a drone be programmed to make context-aware decisions, particularly ones that humans are not very good at? A drone might detect problems before they occur, such as responding to gusts of wind or avoiding unexpected obstacles. A drone might also be able to communicate with other drones.

Can a drone be considered a robot, able to obey Asimov’s Three Laws of Robotics? We need drones that explicitly avoid harming humans and can act to protect themselves from destruction. We should expect this much from any fully autonomous

vehicle. A drone then might be said to have a mind of its own.

Until such time, however, that responsibility falls on the person flying the drone. When you fly a drone, you aren’t just a user — you’re a pilot. You must protect your equipment, yourself, and most importantly, other people. A bad or incompetent pilot can injure people or invade their privacy. It’s not a lot different from owning a pet or a car.

Good pilots, like the Drone Dudes, worry that bad or careless pilots will garner the public’s attention, create a climate of fear, and cause governments to restrict or eliminate drones for commercial or recreational use. The reason we need better technology is that few of us are very good pilots.

For makers, the most interesting challenge isn’t just building drones or flying them. It’s discovering what drones are good for, what creative uses they have, and what tough problems they might solve. Otherwise, planes and quadcopters will be sold only as toys, not tools, and many people will discard them once they lose interest in their playthings. We’re hoping drones become platforms for developing compelling applications that will push the technology forward and adjust the balance between the light and the dark side of drones. 🚀



# Print Directly from a Mac<sup>®</sup>

Introducing the first ever Mac print driver for a laser system



Design



Print



Laser it!

**MADEINUSA**

## Now Print from Mac and PC

Along with our Windows<sup>®</sup> driver, we are proud to offer the first ever Mac driver created for a laser system. Designed for the Fusion Laser, it allows laser operators to seamlessly print from a Mac computer to Epilog's Fusion series. Now you can design and print to the Fusion Laser from your favorite Mac or Windows computer!

Contact Epilog Laser today for a laser system demo!

[epiloglaser.com/make](http://epiloglaser.com/make) • [sales@epiloglaser.com](mailto:sales@epiloglaser.com) • 888-437-4564



Don't just **Build** it in...  
**Build** it in...  
**Circuits!**



Program  
in C on  
Mac or PC

Great for STEM\* learning!  
\*Science, Technology, Engineering, and Math



ActivityBot  
robot kit  
**\$199**

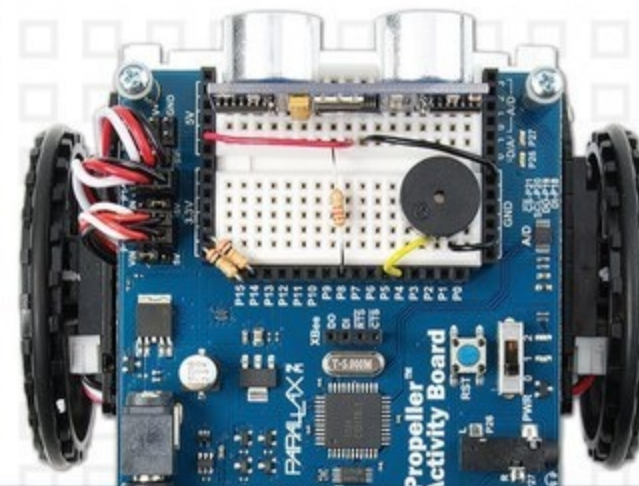

Learn as an  
individual  
or a group

**PARALLAX**  
www.parallax.com  
Equip your genius.<sup>™</sup>

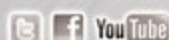

Order ActivityBot (#32500) online or call 888-512-1024 (M-F, 8AM - 5PM, PT).  
See the complete lessons at [learn.parallax.com/ActivityBot](http://learn.parallax.com/ActivityBot)

"ParallaxInc" on Twitter, Facebook, & YouTube  
Parallax and "Equip your genius" are registered trademarks of Parallax Inc.



# Nuclear Fusors, Homemade Sugar Rockets, Hard Cider, and 3D Printing Raves

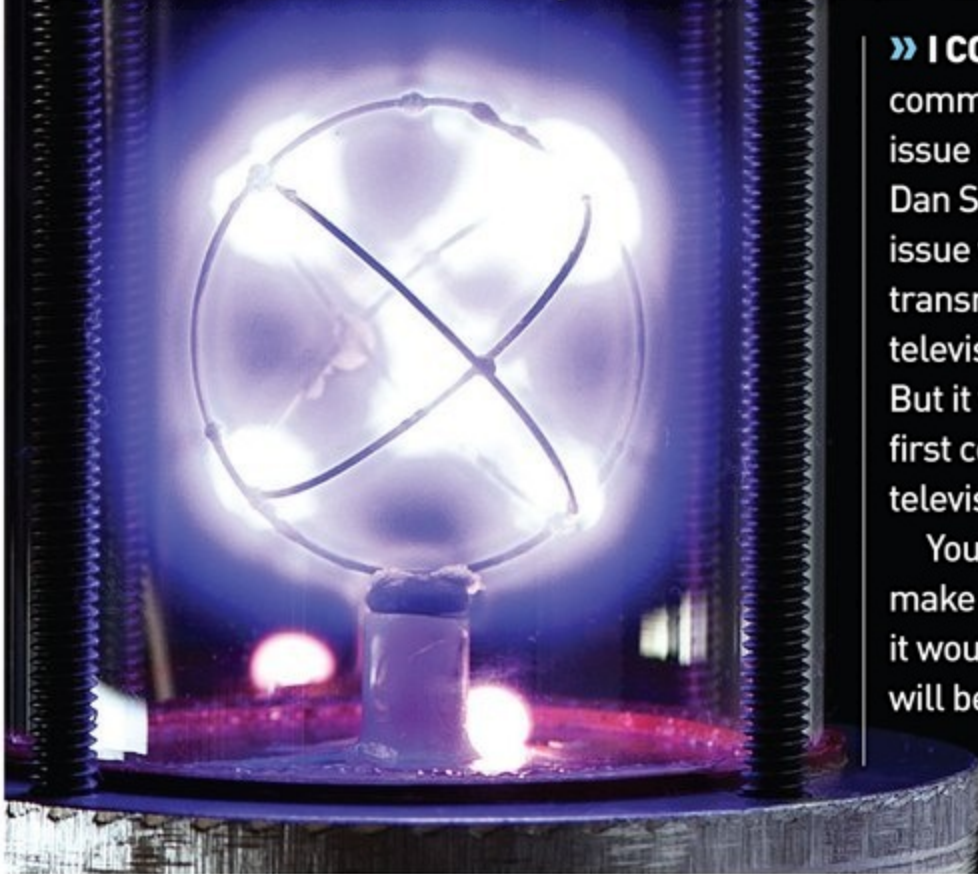

» I CONTINUE TO BE AMAZED AND DELIGHTED WITH MAKE. I have to commend your contributors for their ingenuity and practicality. In the latest issue (Volume 36) I was especially fascinated by the Nuclear Fusor project by Dan Spangler — well written, clear, and concise. I do, though, have to take issue with his statement on page 93 regarding Philo Farnsworth. John Baird transmitted the first televised pictures of moving objects in 1924, the first televised human face in 1925, and the first real-time moving object in 1926. But it was electronics inventor Farnsworth who is credited with inventing the first completely electronic television. So to clarify, it was Baird who invented television and Farnsworth who invented the first fully electronic television.

Your magazine really inspires me up from my seat to get involved and make things. I wish it would be more widely available in the U.K., as I'm sure it would inspire many young inventors and engineers. With this thought, I will be donating a yearly subscription to my old school.

—Christopher Glasgow, Byfleet, Surrey, U.K.



» Earlier this month my son Tucker and I followed William Gurstelle's instructions to build the Homemade Sugar Rockets featured in MAKE Volume 35

(page 70). We failed, learned, failed some more, learned some more, and through persistence had great success and improved the recipe to our liking, and hopefully to yours, too. I hope the following notes on the process will help you with this fast, easy, and super-fun project.

—Wayne Arendsee, Fort Worth, Texas

+ Read Wayne's tips and tricks at [makezine.com/fatherson/](http://makezine.com/fatherson/).

» Thanks for the great tutorial (Volume 36, page 132, "Kitchen-Table Cider Making"). My notes from one batch of apple cider and two batches of pear:

First, the filtration bag gets heavy. I made the apple cider without the bucket with holes and the bag slipped off the larger

bucket and fell in, causing me to have to strain everything again. Second, my brewing bag gets clogged up pretty fast. Strains really well, but requires a lot of squeezing at the end to get all the juice out. Third, the bottled cider flavor really reflects what you put into it. The apples, for example, were tarter than my pears. Fourth, the sugar added beautiful little bubbles. Haven't sampled the non-sugared bottles, yet.

Without the suggestion of using a juicer, I might not have made any cider this year. But your instructions provide a clear and easy path for a first-timer. Well done.

—Matt Friedrichs, via the web

» I gotta admit, I've really been enjoying these practical examples of 3D printing that you guys have been kicking out lately (Make: Ultimate Guide to 3D Printing 2014, page 14, "10 Cool 3D Printed Objects,"). We've seen years of 3D printers kicking out the same Yoda heads. I've frankly been rather skeptical about the "3D Printing Revolution" that's been prophesied, and still am somewhat, but these posts are changing my thinking bit by bit.

—Andy Tanguay, Ann Arbor, Mich.

## IN RESPONSE TO THE B9 CREATOR REVIEW IN THE MAKE: ULTIMATE GUIDE TO 3D PRINTING 2014 (PAGE 93):

» I own a B9 and have been absolutely blown away by the detail it is able to produce. I use it for my business as a product designer and for making N-scale model trains — where it is able to match (yes, match) the detail of injection-molded parts. I had about 15 prints where I made various mistakes but now it pretty much works every time, and Mike Joyce [the founder] has personally helped me to overcome issues along the way — as he has for almost everyone who has bought one of these machines. I have no affiliation to Mike or B9, except as a very, very satisfied customer. If you want small parts with exquisite detail (jewelers, small scale modelers, small product prototypes), then this is the machine for you.

—Robert Fryers, via the web

» It's worth stressing that this entire project has been open sourced by Joyce. I built my own printer, loosely based on his designs and using his software, and he was incredibly helpful as I was feeling my way through. A very generous maker, with a very cool product!

—William Fredette, Worcester, N.Y.

**MAKE AMENDS:** In MAKE Volume 36's Country Scientist column, "How to Use LEDs to Detect Light," in the schematic in Figure D (page 138) the LED should be reversed, with the anode connected to ground and the cathode connected to IC1-2. Thanks to intrepid reader Rob Kuschinsky for pointing this out.



# The MAKE iPad App is coming Jan. 21st!



A totally  
new way to  
experience  
Make!

- Interactive Content
- Video Integration with Tutorials
- Expanded Project Builds

# Make:

Find out more at: [makezine.com/go/ipadapp](http://makezine.com/go/ipadapp)



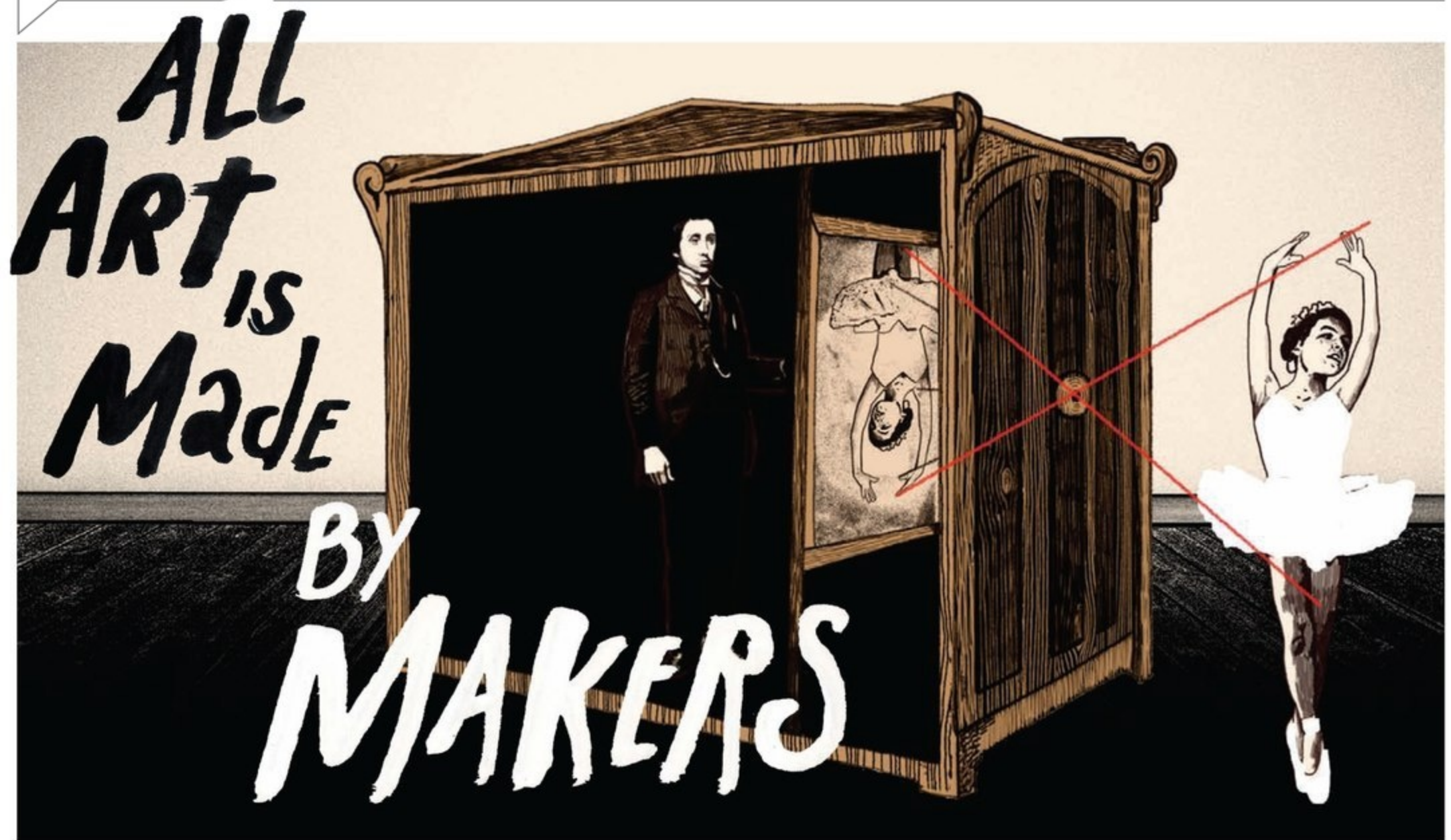

Peter Strain

Museums are living forums and makers are poised to be the power users. *Written By Don Undeen*

### WHY IS THIS GUY FROM THE METROPOLITAN MUSEUM OF ART WRITING AN ARTICLE FOR MAKE?

When I started as a “computer guy” at the Met, I thought of an art museum as a quiet place where pretty things hang politely on the wall, and art objects as the product of a singular genius I could never understand.

Then I learned about camera obscura, a simple box with a pinhole for light to pass through. This device, often utilized to view solar eclipses, was used by portraitists as early as the 17th century to create likenesses of photographic quality. I wondered, “Isn’t that cheating?”

I started asking more questions, learning how artists availed themselves of the latest technology and tools to push their craft to greater heights of expression. I learned about the possibility that Dutch master painter Edgar Degas may have used a camera obscura to aid his genius. I then realized that all art is made by makers.

As a “museum insider,” I can tell you that many museum professionals are thinking hard about how to remain relevant, without “dumbing down” or compromising their integrity. I’m convinced

that the answer lies not in adding flashy new tech to their galleries, but by direct engagement with the maker community.

Creative, curious, hands-on masters of the tools at their disposal. That sounds like a description of both artists and makers. To the maker definition, I’d also add a deep commitment to teaching and sharing, which is what museums also do. This is why, in my role as the manager of the MediaLab at the Met, I’m so interested in increasing communication between the maker community and the museum community. Makers could be the museum’s “power users” — returning frequently, looking carefully, questioning bravely, and most importantly, sharing widely.

Remembering that all art is made by makers, the museum’s rich collections and deep expertise reward power users. I challenge every maker to befriend a curator, conservator, or educator at their local art museum. Cupcakes help. You’ll find that many of them are happy to drop the art-speak to answer questions of a more practical nature: How was this sculpture made? How did the artist achieve that exquisite polish, that gravity-

defying curve? What tools did she use?

While you’re at it, take the time to ask why. What was the artist trying to say? What problems, technical and artistic, were they dealing with, and how did their tools and techniques address that? I don’t doubt that you’ll start seeing your own work in a new light. Maybe you’ll take some of the techniques you’ve learned about and use them to add new refinements to your projects. Maybe you’ll turn your modern making tools to addressing those big “why” questions and produce works that stand on their artistic merits alone.

Whatever you do, tell your fellow makers all about it. Spread the word! Museums aren’t just repositories of lifeless objects, but a living forum, where the creative spirit and technical skills of past artists are in constant conversation with makers of the present and future. 🍪

### DON UNDEEN

is the manager of the Met’s MediaLab, which aims to explore the impact technology can have on the museum experience by bringing the creative technology community into close conversation with museum expertise. [@donundeen](https://twitter.com/donundeen)



# Seize the Moment

How I hack my education by learning hands-on skills from the makers in my community. *Written by Logan LaPlante*

Luke Jacobsen



## LOGAN LAPLANTE

Learn Logan's tips on internships, see the entire ski-making process, and watch his TEDx talk, "Hackschooling Makes Me Happy." [makezine.com/seizethemoment](http://makezine.com/seizethemoment).

**MY NAME IS LOGAN LAPLANTE. I'M 14 AND I HACKSCHOOL.** I'm taking control of my education so it reflects who I am and what I want to do. I don't go to school in the traditional sense. I don't use one particular curriculum, and I'm not dedicated to any particular approach.

Hackschooling is like a remix or a mashup of learning. It's flexible, opportunistic, and never loses sight of making happiness, health, and creativity a priority.

I'm consciously taking advantage of opportunities in my community (in Incline Village, Nev.) and within my network of friends and family to build my education. For example:

- » I spend one full day a week interning at either Moment Skis in Reno, Nev., or Bigtruck Brand in Truckee, Calif.
- » I'm a member of the Squaw Valley Kids' Institute, a community of kids who study interesting world thinkers and activists, like Joel Salatin and Sir Ken Robinson. Before these speakers present to hundreds of Tahoe locals, we get to sit in a tiny huddle, shoulder-to-shoulder, and ask them our prepared questions.
- » With a couple of friends, I take chemistry class from a biochemist who conducts research at the University of Nevada Reno and wants us to learn from making. This week we made ice cream using liquid nitrogen!
- » I take a Constitution class from my friend's mom who spent her summer taking a seminar on U.S. history in order to teach us.
- » I participate in events put on by the Holland Project, an organization of kids that brings the arts to kids.
- » I ski competitively, take math online, read what interests me (like the original Conan books), edit video, study Brazilian jiu-jitsu, and am starting my own clothing company with some friends.

Basically, while my friends are away at school preparing for life, I'm living it. Some people call what I do "home-

schooling," but really, I prefer to learn and make away from home.

By far my favorite way of hacking my education is being an intern. My internships at Moment and Bigtruck give me a clear sense of community, depth, and pride. I get to make things I'm proud of with people I admire.

I remember the first time I got to wear a five-panel hat I designed at Bigtruck. I was skating to my friend's house and when I got there he complimented my hat and asked where I got it. I told him I made it. It made me feel proud that someone noticed something I designed and sewed myself.

My friend Max Louis Miller lives in New York and is a designer for Moment. I've always admired his designs and graphics. They're strange, which makes Moment so unique. Two winters ago, I got to sit down with Max, who was out West designing the 2012–2013 line, and we made some weird designs together. The next year, on the hill, I looked down at my new pair of Moment skis and saw one of my ideas from that night. I had made my first mark on a ski.

Now, as an intern, I'm a part of the whole ski-making process at Moment, from the computer and a plank of wood to running the CNC saw and attaching sidewall and fiberglass and carbon fiber. I put the skis in the heat press and cook them for 40 minutes. I participate in many steps of the process, and then I get to click in and jump cliffs on them. Most people think their skis are planks of wood with a plastic sheet overlay. Because of my hackschooling knowledge I feel more deeply connected.

Internships are a great way of getting involved in your community, getting an education from people you admire, and having fun. What most people don't realize is that when you're a kid you have a better chance of getting really cool internships. These opportunities are time limited and should not be passed up. 🍌



# MADE ON EARTH

#madeonearth

The world of backyard technology

Know a project that would be perfect for Made on Earth? Email us: [editor@makezine.com](mailto:editor@makezine.com)

## ALTARED REALITY

DAYOFTHEROBOT.COM

On a trip to Mexico, artist Chad Meserve fell for the playful and quirky skeleton dioramas of the Día de los Muertos *ofrenda* — a traditional altar with offerings for the deceased. Once home again in Burbank, Calif., he began to extrapolate the *ofrenda*'s post-apocalyptic descendants: scenes starring robots in place of skeletons. This series of miniature sculpted figures depicting day-to-day human activities is *Day Of The Robot*.

After a normal day's work immersed in other filmmakers' worlds, Meserve retreats to the workbench to create his own. Starting each new scene from scratch, he makes every figure, costume, and prop by hand.

Lamenting that the classic diorama has become "an art form marginalized by mandatory school projects," he knew his debut scene had to be something universally recognizable and accessible, and so he created the *Robot Nativity*. After receiving a rare positive Regretsy nod, that first Nativity sold almost immediately, and things took off. After that, "I focused on everyday human moments. I imagine all these robots stuck in the world we created, the world they took from us. They didn't count on needing meter maids and bicycle repairmen. These otherwise autonomous machines wind up enslaved to our inane habits and outdated technology."

—Gregory Hayes



Gregory Hayes



# AGNES THE KNIT BOT

FACEBOOK.COM/AGNES.ROBKNIT

Agnes blinks, looks around, and drops her gaze back to the task at hand — knitting. True to her name, Agnes Roboknit is a humanoid robot that knits on a circular loom, periodically lifting her head to look side to side and blink. Artist and inventor **Andy Noyes**, who lives in southeast England, explains, “I wanted her to look human from a distance, but obviously be a machine closer up, with metal parts on show.”

DC motors drive her joints, using homemade gears. In fact, almost every part of her body was handmade, including her silicone face and her hands — latex made from plaster casts of a real person. The original plan had her knitting with needles, but after Noyes learned how to knit himself — a necessary step in his design process — he realized a loom would be easier. Agnes debuted at the 2013 Maker Faire U.K.

Why the name Agnes? “To start with it was A.G.N.E.S., and I wanted it to be an acronym as if from the early days of computers. Though I couldn’t think up a good acronym so it just became Agnes,” he recalls. “Also my grandmother, who used to knit — as all grandmothers do, don’t they? — was called Agnes.”

— *Laura Cochrane*



Agnes’ arms contain electric motors salvaged from old desktop printers.



## ROBOT BALLERINAS

BLACKLABELROBOT.COM

The geometric frames and Arduino-controlled servos of Brooklyn-based **Ricardo Cid**’s *Robot Ballerinas* don’t bear a strong physical resemblance to human ballerinas, but the concept behind them is similar. Cid poses a question: Can writing a piece of code be equivalent to writing a piece of choreography?

— *Andrew Salomone*

Gerardo Cid



# MADE ON EARTH



TRANSFORMED: Hetain Patel mutates the humble Ford into a looming 8-foot-tall sculpture with the help of his father, Pravin Patel.

## MORE THAN MEETS THE EYE [HETAINPATEL.COM](http://HETAINPATEL.COM)

U.K.-based artist **Hetain Patel**'s first car was a 1988 Ford Fiesta handed down from his father, **Pravin Patel**. In his first sculptural work, a collaboration with his father and engineer brother, **Pritum Patel**, he reconstructs a similar vehicle into an unexpected Transformer-like figure in a comfortable squat.

Patel writes, "This posture is a recurring image in my work and forges a link between the lower classes in India and my immigrant family in the

U.K., both of whom sit comfortably this way."

The build took three months and uses only parts from the Fiesta, with the exception of the springs, which ironically were sourced from a Rolls-Royce. Patel's father, who converts cars into hearses and limousines, was responsible for the welding, cutting, and advising what was structurally possible.

Patel's work regularly addresses issues of identity and perception, and

*Fiesta Transformer* is no exception. He explains, "For me, these 'robots in disguise' (as per the cartoon's theme tune) stand as a metaphor for the other, in a fantasy world where they can transform out of a marginal position into one of empowerment. ... Unlike the popular toys and films, the car here is not a high-powered sports car or truck transformed into a powerful warrior, but rather a small inexpensive Ford Fiesta."

—Goli Mohammadi



# THE CALM IN THE MACHINE

VIMEO.COM/52541217



Photo ECAL/Nicolas Genta

The circular knitting machine, used in World War I to produce fresh socks quickly to combat troops' trench foot, can now be used to keep our heads warm while we relax, thanks to an ingenious contraption called *Rocking-Knit* by **Damien Ludi** and **Colin Peillex**, created during their studies at École cantonale d'art de Lausanne in Switzerland. While its whimsical appearance is akin to something conjured up by Dr. Seuss, its use is completely functional.

Consisting of a modified circular knitting machine mounted above a rocking chair, *Rocking-Knit* produces knitted fabric tubes that are turned into hats by simply rocking in it. The device channels the back and forth motion through a series of gears, and the crank-operated mechanism, which causes the circular knitting machine to knit, is slowly turned and the fabric is knitted, stitch by stitch.

Although *Rocking-Knit* may not improve the efficiency of knitted hat production, it does utilize time and energy that would be wasted otherwise. Perhaps the most successful aspect of this imaginative project is that machine knitting tends to lack the cathartic relaxation that has made hand knitting such a popular and enduring activity; *Rocking-Knit* seems to add the catharsis factor back into the experience of machine knitting. —**Andrew Salomone**

# MAGNIFICENT MAZE

ORIGAMATA.COM/PROJECTS/BIGBALLMAZE

If you visited Maker Faire Bay Area the past two years, you may have happened upon this amazing Big Ball Maze Game by locally based maker **David Thomasson**. The game gives the defamiliarization treatment to the traditional handheld maze game by making it too big to be handheld and, to give the user a whole new experience, there are a multitude of Arduino-controlled interfaces, including: video game controller, smartphone, body position, brainwave headset, and visual feedback. —**Andrew Salomone**





## BRICKS FROM THE BEYOND

WORLD OF ODAN.BLOGSPOT.COM



New York-based graphic designer and artist **Mike Doyle** is a Lego master known for thinking outside the brick. He first caught our attention in 2011 with his beautifully rendered, black-and-white, eerily dilapidated Lego Victorian houses.

His latest piece, titled *Contact 1: Millennial Celebration of the Eternal Choir at K'al Yne, Odan*, employs more than 200,000 bricks, took over 600 hours to build, and stands 5 feet tall and 6 feet wide. Images of the piece are so unreal that they leave the viewer wondering if they aren't renderings. Doyle responds, "The project is built and then photographed. 90% of the saucers are connected to the model with black Lego hoses. These mostly disappeared against a black screen."

*Contact 1* is the first in Doyle's *Contact Series*, large-scale, sculptural storytelling based around the mythical world of Odan, "celebrating spirituality, peaceful ET contact, and fantastical worlds." Doyle is currently working on the next piece in the series: *The Great Temple of Odan*. He navigates Lego like such a lifelong pro, it's hard to believe he began working with Lego as an alternative art medium merely three years ago. Doyle's new book, *Beautiful Lego*, takes an in-depth look at exceptional works born out of the Lego artist community.

— Goli Mohammadi



# Subscribe to the new MAKE and get the Ultimate Guide to 3D Printing 2014 PDF free!



**SPECIAL ISSUE: 3D PRINTER BUYER'S GUIDE • 23 PRINTER REVIEWS!**

**Make:** 3D SCANNERS ARE HERE page 96

**NEW FOR 2014**

**More Make, More Often!**  
Make is now in a larger format and six times a year.

**ULTIMATE GUIDE TO 3D PRINTING**  
\$300 TO \$3000: WHICH PRINTER IS RIGHT FOR YOU?

<b>Printer + CNC all-in-one</b> Here comes the "everything" machines	<b>MakerBot and Stratasys</b> What a \$617M acquisition means for 3D printing	<b>3D Printing Photo Booth</b> Turn your guests into figurines	<b>DIY Filament Extruder</b> Say goodbye to expensive plastic
---	--	---	--

**MAKER MEDIA** [makezine.com](http://makezine.com)

**GET MORE MAKE FOR THE SAME GREAT PRICE.**

**Subscribe today for only \$29.95!**

# Make:

[makezine.com/go/3dguide](http://makezine.com/go/3dguide)





Nemo's fish tank home is controlled by a Raspberry Pi and an Arduino.

## MACQUARIUM

[HAYDENKIBBLE.COM/THE-INTERNET-ENABLED-FISHTANK](http://HAYDENKIBBLE.COM/THE-INTERNET-ENABLED-FISHTANK)

What has your fish tank done for you lately? U.K.-based **Hayden Kibble** decided to transform an old Mac G5 into a super-smart home for his goldfish, Nemo. After exhibiting it at Manchester Mini Maker Faire in 2012 and getting feedback from fairgoers, he made improvements.

Now, the futuristic fish tank has automatic feeding, timed LED lighting, water depth monitoring, a digital thermometer, an underwater fish-cam, an LCD status display, a servo-controlled filter and bubbles, and best of all, can display your text message on the scrolling matrix display or read it aloud with a computerized male voice. A tidy web interface allows Nemo's caretaker to monitor the system from afar.

—*Laura Cochrane*

## VIDEO SANS-VIDEO GAME

[POMP.COM/VSVG](http://POMP.COM/VSVG)

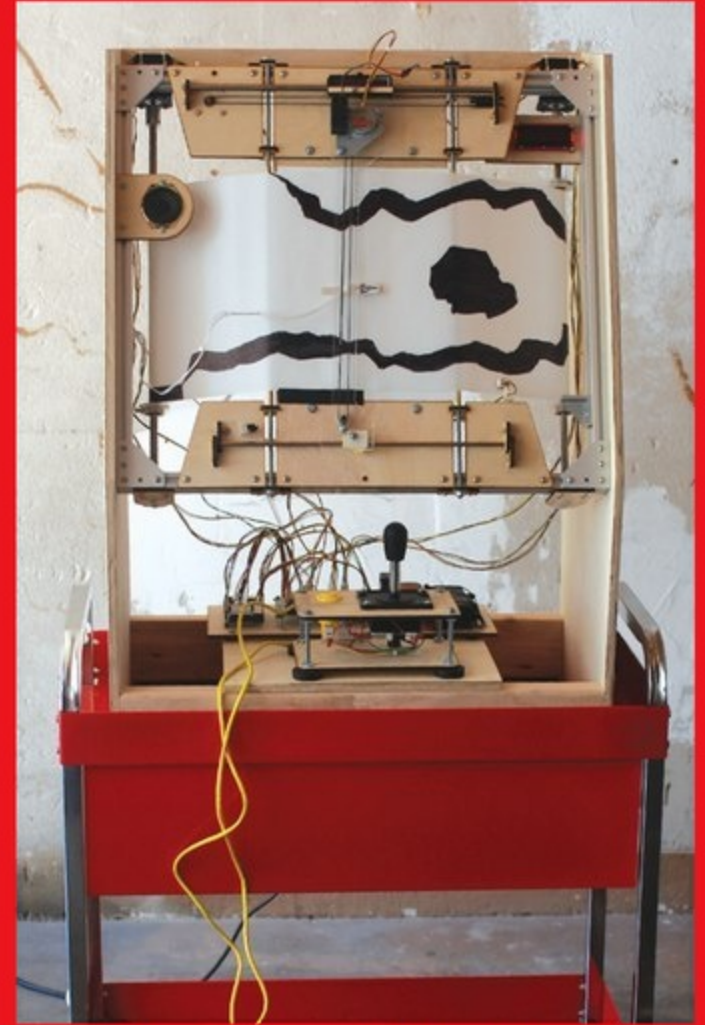

Throughout childhood, **Michael Newman** could usually be found doing one of two things: racing through a video game or drawing levels he wished were playable.

His adult creation, Video Sans-Video Game, allows players to dream up a world, draw it, and then play it using a joystick to navigate a spaceship. It works by outfitting the ship with light-sensitive sensors scavenged from multi-use printers, combined with custom 3D-printed parts and an Arduino Mega microcontroller.

"It turns the idea of a video game level on its head, making it into this amazing analog contraption," says tech icon Veronica Belmont of Newman's creation, which won the "Show Your Stuff to Veronica Belmont" contest at the 2013 Maker Faire Bay Area. "It takes the trope literally: it's a side-scroller game, but the joke is that it's a real, physical scroll."

Newman, who's from Vero Beach, Fla., plans to add a point system and build a smaller version. The game accepts levels drawn by anyone, so he looks forward to others' creations. "Just because as a little boy I drew spaceships doesn't mean that you couldn't draw robots or sea horses."

—*Janet Jay*



# TURNING TIDES

PROJECT: BUILD YOUR OWN PEPPYTIDE AT [MAKEZINE.COM/PROJECTS/PEPPYTIDES](http://MAKEZINE.COM/PROJECTS/PEPPYTIDES)

To make it easier for students to understand the protein folding pathways of polypeptides, scientist **Ronald Zuckermann** and his colleague at Lawrence Berkeley National Laboratory's Molecular Foundry, **Promita Chakraborty**, created Peppyptides — physical models of polypeptide chains made of 3D-printed parts, screws, and magnets.

"Although computer graphics provide beautiful 3D representations," says Zuckermann, "you really lose the sort of tactile feel and the intuitive sense of the flexibility of these chains, which fold into structured proteins, without something you can hold and play with."

In a hands-on session at a nearby college, "four out of five students were able to fold it," says Chakraborty. "It's a big achievement given that the chain is so complex."

The two are now looking at human-computer interaction. "With some augmented reality-type hardware and software," says Zuckermann, "you may soon be able to link a Peppytide to a computer so that as you twist and fold it, the computer can be tracking your movements and then use that information to perform calculations or compare its similarities to say, hemoglobin."

—Laura Kiniry



# GIVING NEW LIFE TO A HANGMAN

[GAMES.UCLA.EDU/GAME/BINARY-GALLOWS](http://GAMES.UCLA.EDU/GAME/BINARY-GALLOWS)

Although the game of hangman has traditionally been played by drawing shapes reminiscent of 0s and 1s to make a stick figure on the gallows, Los Angeles-based artist, hacker, and teacher **Chris Reilly** has devised a new way to use 0s and 1s to play the game.

Binary Gallows is a handsome contraption consisting of an Arduino-based electro-mechanical interface outfitted with an eight-button binary keyboard. The player uses these buttons to guess the letters of a word by inputting their binary sequence, using a chart displayed on the interface. Once the player has entered their guess a knife switch is pulled to submit it. Correct guesses are represented by a row of five green light bulbs, which individually light up to represent a letter. Incorrect guesses result in a mechanical buzz. If the player doesn't guess the word within the allotted number of tries, the loss is signaled by a loud MIDI version of Chopin's funeral march.

Perhaps a more civilized ending than seeing a representation of a dead man on the gallows, but then again, throwing a knife switch like that does suggest there could be a dead man in an electric chair somewhere.

—Andrew Salomone



Relays and multiplexing chips let one small Arduino control dozens of inputs and outputs.





## HOW A DEDICATED TEAM OF STUDENTS BUILT A WORLD-CLASS RACE CAR AGAINST ALL ODDS.

**Each year, dozens of collegiate teams flock to the New Hampshire Motor Speedway to compete in the International SAE Formula Hybrid Competition, a grueling four-day event where students race formula-style gas/electric hybrid race cars that they've designed and built.**

**REWIND:** It's April 29, 2011, two days before the competition. The Yale University team, Bulldogs Racing (BDR), is at an off-campus site testing their race car one last time. Tears of joy stream as thousands of man-hours from a small but dedicated team of about a dozen students is finally realized — the beast is in motion and it's looking good! Minutes later those tears

shift from joy to despair. In the most improbable of scenarios, a single bolt had come loose, jamming the engine, and tearing the transmission to shreds. With not enough time left to source a new transmission, a year's worth of work is gone. Game over. Sorry, Yale.

Unfortunately, the 2012 season wasn't much better for the Bulldogs. Long story short, they didn't even come close to making it to competition. The team was a little light, and in a way it's understandable. Not only did Yale have a poor history of even getting a car to the competition, they never did very well when they did make it there. Getting students to trade every Thursday, Friday, and Saturday night

of their college experience for something that has a strong likelihood of failure is a pretty tough sell. Imagine the recruiting poster: "Compromise your grades, miss out on social opportunities, sleep less than you ever thought was possible! Join Bulldogs Racing!"

**PAUSE:** So why do they do it? Because it's not about winning, or even the race for that matter — it's about the experience. Ivy-league prep assumptions aside, many Yale students would rather don safety glasses than a bow tie. They may not know anything about suspension geometry, laying carbon fiber, or tuning an engine when they sign on, but they join to learn.





THE CHAMPIONS: (Back, left to right) Alex Villarreal, Hari Vasudevan, Alex Carrillo, Joe Belter, Joseph Zinter, (front) Chinmay Jaju, Yusuf Chauhan, and Adam Goone.

For most students, it's both empowering and humbling. Empowering, in learning how to transform hunks of metal and plastic into functional parts. Humbling, in that the former is much more difficult than it sounds. Mostly though, it's about being part of something bigger than themselves. In 10 years, most students probably won't remember their linear algebra course, but they'll never forget the feel of brake fluid on their hands, the sweet smell of an angle grinder ripping through steel, and more than anything, the late night camaraderie and laughs.

It goes without saying that building a race car is a pretty lofty endeavor, especially for students who have likely spent more hours playing video games than turning a wrench. A race car is thousands of carefully designed, machined, and welded parts, all working in unison to tear around some type of course without falling apart. Here, we're talking about a hybrid vehicle, so now add to the mix a complex electrical system consisting of high-power circuits to drive a motor and

low-power circuits to control everything else.

The Formula Hybrid Competition consists of three dynamic events: an acceleration run, an autocross event, and an endurance race. Each team is limited in the amount of "energy" they can carry, and they're free to distribute it between gasoline and batteries as they see fit to maximize their performance in the three events.

**▶ FAST-FORWARD:** In September 2012, two sophomores, Alex Villarreal and Chinmay Jaju, decide to turn BDR around. Neither had much experience, but they weren't short on gumption. With a few thousand bucks and a poorly outfitted garage (which incidentally doubled as a loading dock), they set out to revamp BDR. The first stop was a new faculty advisor to mentor the team and supervise the build. Dr. Joseph Zinter, assistant director of the Yale Center for Engineering Innovation and Design (CEID), was the logical choice: a serial maker and gear head who feels more comfortable in welding leathers

#### **ALEJANDRO (ALEX) CARRILLO**

is a sophomore electrical engineering major at Yale University, and hails from Brooklyn, NY. In his spare time he builds robots, explores NYC history, and teaches people how to do the same.

#### **DR. JOSEPH ZINTER**

is the assistant director at the Yale Center for Engineering Innovation and Design (CEID), a lecturer in the Department of Mechanical Engineering and Materials Science, and the proud faculty advisor for the Bulldogs Racing Team.





Using old-fashioned boat-building techniques and laser-cut plywood cross sections, Alex Carrillo creates the plug for the race car body.

1. Joe Belter and Chinmay Jaju CNC-machine the uprights.
2. Belter and Jaju test-fit the uprights on the welded chassis.
3. The plug gets a final release coat before being used to make the fiberglass molds, which are then used to create the carbon fiber body.
4. The bare bones BDR race car on day one of testing.
5. The Bulldogs Racing Team performs some final tuning on the car.
6. On the final day of testing, things are looking solid for the BDR team.

than a tweed coat. Zinter agrees under one simple rule: "If we do this, we go all in."

Months of designing, calculating, planning, and sourcing parts were followed by long hours in the garage and machine shop transforming piles of raw materials into a chassis, drivetrain, steering system, suspension, electrical system, body, and finally, a race car. It was one hell of a year — each student pushed further than they'd ever been, with many unforgettable stories, travesties, and successes along the way, but the best part of this story comes from what happened at the race.

**▶ PLAY:** On the morning of the 2013 competition, BDR rolls into the New Hampshire Motor Speedway, passing dozens of professional-looking race-car trailers from schools across the country. They park and assemble to lift their race car from the back of a rented U-Haul truck. Yale already didn't have a great reputation at this race, and the U-Haul didn't help, so a few snide remarks were expected (and received). It was all good, though, and the team is just happy to be there — even days before the race, they weren't sure they would make it.

The first, and sometimes the most challenging, part of the competition is inspection, where professionals spend hours going through each car to make sure the vehicle is safe and mechanically

and electrically sound. Each team is given a list of things to change and fix, then it's off to the pits for frantic repairs and modifications. Here, every minute counts. If a car doesn't pass inspection in time for an event, it isn't allowed to compete. About a quarter of the teams never pass inspection and are relegated to watch the other schools race from the sidelines.

Despite minor modifications, the BDR car is the first to pass inspection, and the other schools start to give Yale a second look. The Yale team is one part stoked and one part haunted by their history, assuming something will inevitably go wrong. They prep for the first event, the acceleration run, just hours away. The car is ready, every bolt double-checked, and it exudes confidence, but the team seems far less poised.

Then, the chaotic pits come to a screeching halt when it's announced that the autocross course is open for a walkthrough. Autocross would be the second event of the day, and crew members from all schools run over to see what they'll soon face.

Yale had done their homework, studied the previous years' courses, and designed their gearing accordingly. Historically, the autocross course was tight, favoring quick acceleration and high torque, but you could have driven a dump truck through this layout. It was wide open and much more designed to favor high speeds.



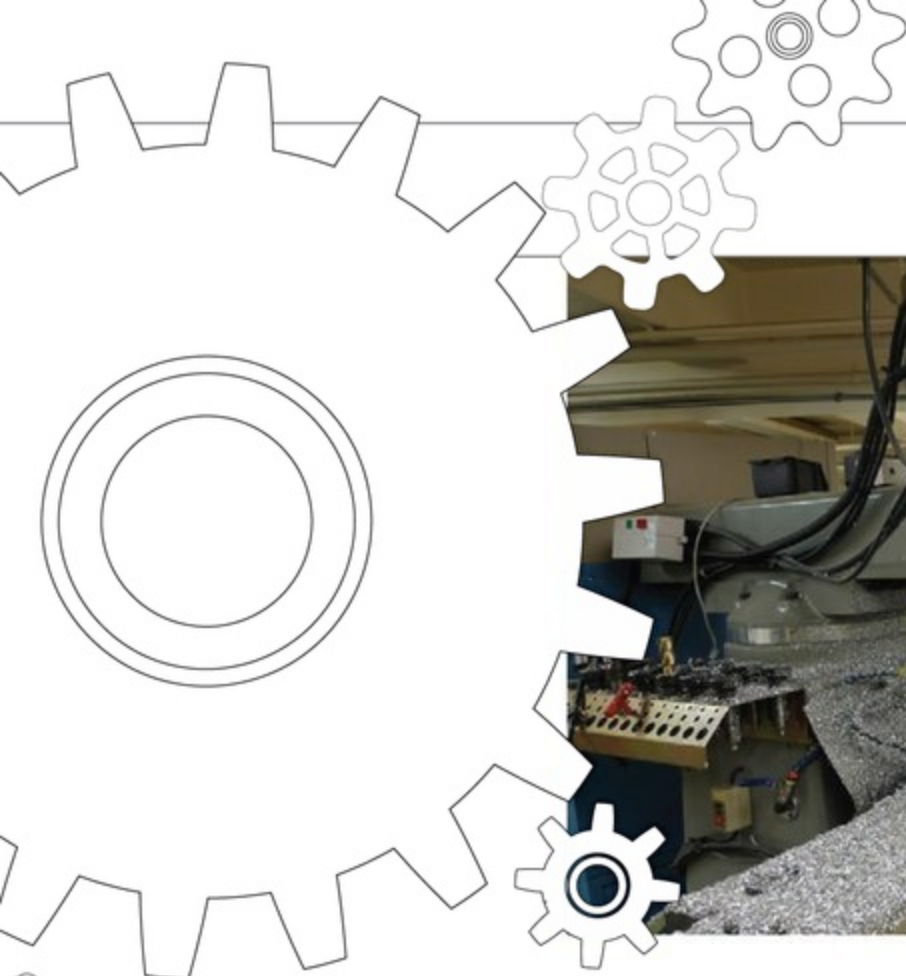

In talking with other teams, the Yale race car had one of the lowest top speeds around.

The competition requires teams to maintain the same gearing for all events, so the Yale team quickly recognizes they're in serious trouble, since autocross accounts for twice as many points as the acceleration run. After a quick team huddle, they decide to change their gearing, but at this point, they only have about 45 minutes to do it. The adrenaline is seriously pumping, and a year's worth of work is on the line.

"It was like a NASCAR pit stop without the tools you need," said Alex Carrillo, a freshman who wore two important hats on the team: control systems lead and comic relief. In an absolute fury they jack up the car, and remove the body and the sprockets on the engine and motor. They are organized, ready, and on track to make it to the line in time. They shorten the chains and loop them around the newly installed sprockets.

"We have a problem," says Joe Belter, a graduate student in mechanical engineering and the resident mechanical guru. It only takes seconds for the gravity to set in. The new sprocket configuration is such that they can't get both the motor and engine chains to be safely tensioned. "Half link," barks Zinter. "We don't have one — they don't exist for this size chain," says another team member. "I know, *make* a half link," says Zinter. In true MacGyver fashion, with only a vice and angle grinder, sparks fly. In less than five minutes, greasy, shaking hands create and install the fix. After a quick reinspection, the team dashes the car to the starting line of the acceleration event, with only seconds to spare before disqualification.

Fingers are crossed, and the team is praying the car makes it down the track in one piece. Belter is behind the wheel. He rolls to the line, gets the thumbs up, and roars down the straightaway. The crowd is cheering, and all eyes shift from the car to the clock. The

collective jaw of BDR drops as they hear the announcer: "At 5.283 seconds, Yale resets fast time for the day." The unlikely Yale would end up winning the acceleration run.

The elation was short-lived, as the autocross event was just around the corner. After having calmed the butterflies, a quiet confidence is starting to set in on the BDR team, the type you would expect from a well-oiled machine that has been running nonstop for a year.

They roll the car to the line. Adam Goone, a senior in mechanical engineering, is behind the wheel. Goone is one of two seniors who had stuck with BDR for the entirety of his college career, and the day he'd dreamed of is finally here. Despite having been through a physical and emotional roller coaster in those four years, he's as cool as ice, a born driver.

He gives the crowd and thousands of people watching online quite the show when the rear end slips out from behind him around a tight turn. He loses it and is headed for the grass. Hearts stop, but after an amazing recovery, he continues to tear up the track, and ultimately claims victory in the autocross event.

Yale would end up winning the endurance event as well, sweeping the competition and coming in first place overall: International SAE Formula Hybrid Competition champions. Oh, and the custom half link held up just fine.

It was a motley crew if ever there was one. Quite a few team members didn't know the difference between a nut and a bolt when they started, the engine tech and welder was an anthropology major, and the chief engineer didn't have a driver's license. When you think Yale, you probably don't think engineering or making, but this small team on a shoestring budget (while dodging deliveries on a loading dock) was able to build a world-class car. It just took a little gumption, a few sacrifices along the way, and a strong desire to make. 🍀





# Radically Cheap



TEXAN BUILDS MACHINE TOOLS FROM CAR PARTS TO SAVE THE WORLD.

Written by Paul Spinrad



**The ex-rancher felt empathy push his problem-solving mind into a new direction.** He looked back at all those years he had tinkered with junk-built machine tools in his workshop — all that time spent poring over scans of antique how-to magazines looking for clever hacks to avoid having to buy new tools. It was fun and sometimes necessary for me, he thought, but what I've created here can also help many people.

This is the story of Pat Delany, one of the leading creative voices in Appropriate Technology — technology that is small-scale, decentralized, labor-intensive, energy-efficient, environmentally sound, and locally controlled. This 78-year-old grandfather came to the field as an outsider, inspired by a second-hand description of a news photo. But his visionary home-built machine-tool designs now have the potential to help millions bootstrap themselves out of poverty. Delany never had much money himself, or any formal engineering education, but his personal quest to develop open-source DIY machine tools has been embraced and spread by Appropriate Technology's conference-hopping, grant-getting establishment.

Delany had worked with machines for his entire life and built many machines for himself. Back in the 1950s he paid his way through Tulane as an industrial electrician and then continued as an electrician in New Orleans. Working at the Jackson Brewery when it shut down in 1973, he followed an opportunity to move to Palestine, Texas and raise cattle, which he did until the sector crashed in 1982.

With his last \$525, he started an oil and gas information service, Rigmach Information, which originally ran via dialup on his son's RadioShack Model 1 computer. A nearby lightning strike fried the computer, so he bought more than 30 replacements for \$10 each at a RadioShack company sale. After many thunderstorm seasons, he finally ran out of these "servers" just as the worldwide web came along. By economic necessity, Delany worked on Rigmach well into his 70s; only recently did his 39-year-old son Mike finish taking over the business. (The family also includes wife Clarissa, sons Stratton and Colin, daughter Megan, and seven grandchildren.)

## THE MULTIMACHINE

About 13 years ago, Delany decided to build himself a horizontal milling machine on the cheap. He was stuck on finding the right parts until he came across the article "Build the 'Engine Mill'" by G. A. Ewen, in an issue of *Machinist's Workshop*. Ewen's handy little DIY mill was built from a four-cylinder car engine block — a solid chunk of metal that's sourceable from any junkyard — but has the strength, weight, and precise geometry to make an ideal frame for a small machine tool. As Delany explains in the documentation for his now-famous project, "cylinder bores are bored parallel to each other and at exact right angles to the cylinder head surface."

Delany expanded on Ewen's engine block idea to create an all-purpose metalworking station that he called the MultiMachine (see page 26). It's a creative mashup of old designs, new ideas, and cheaply available parts that functions as a combination lathe, mill, and drill press. Delany has used it to resurface a neighbor's brake rotors, among other things. Naturally, he continued experimenting with the MultiMachine and improving it after he first got it working. He put a chop saw blade on the spindle, for example, and found that it also makes a great saw.

## PAUL SPINRAD

is a broad-spectrum enthusiast, writer, maker, and dad who lives in San Francisco. He hatches schemes at [investian.com](http://investian.com).

Pat Delany

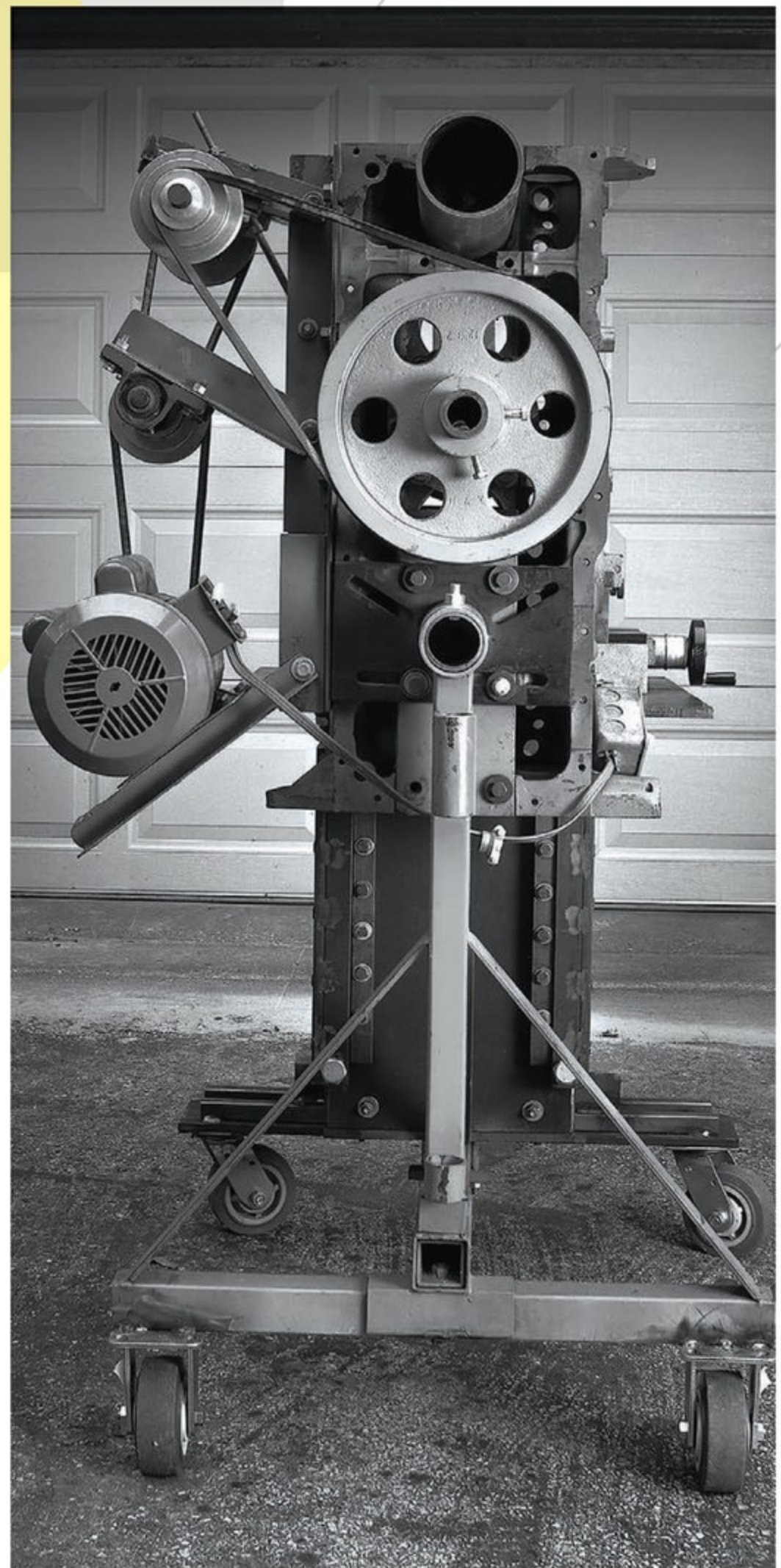

**TOOL OF EMPOWERMENT:** Built entirely from scrap car and truck parts, Delany's open-source MultiMachine is a complete machine shop in one tool, with no electric power necessary. The implications for developing countries are immense. Learn how to make your own and read about his other open source machines at [opensourcemachinetools.com](http://opensourcemachinetools.com).



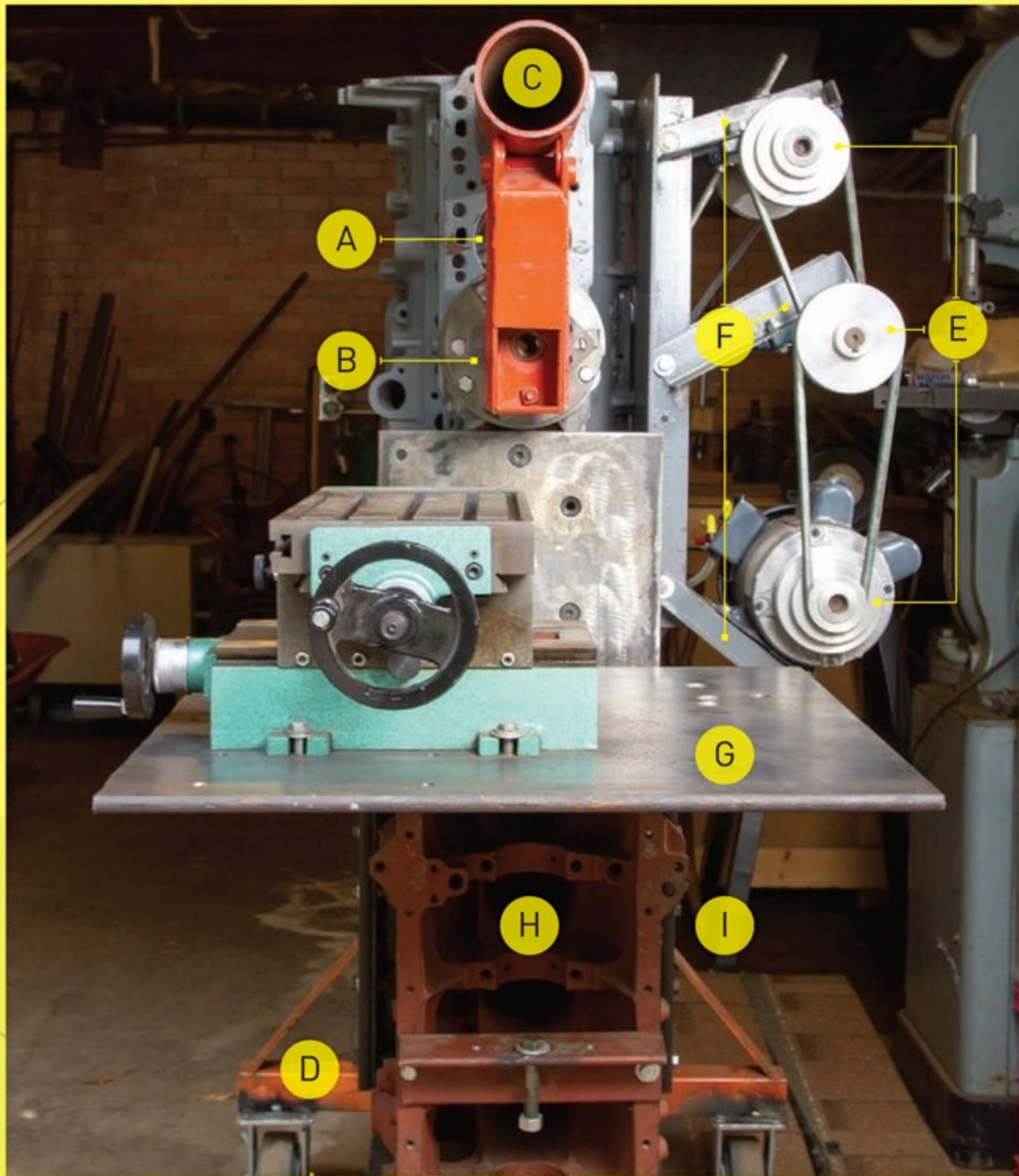

## MAKING A MULTIMACHINE

Delany's MultiMachine is built on two engine blocks. The six-cylinder block in back (A) uses one bore to hold the mill's spindle (B) and another above it to hold an overarm (C), which extends out to hold a tailstock for using the machine as a lathe. The block is held up on a wheeled engine stand (D). Driving the spindle, and mounted around it, are a fast motor, a slow motor, and three pulley clusters (E), all of which allow the user to run the spindle at a range of speeds and torques by swapping belts around. These drivetrain components are bolted to existing mounting holes on the block, like for the oil filter or to angle iron brackets (F) bolted to new holes drilled and tapped in the block. The spindle itself is just a piece of pipe that rotates inside bearings salvaged from a car differential.

Key to his design is what he calls the "adjuster," a small ring around the spindle that acts like a bike axle ball bearing adjuster. A variety of tools — like

a lathe chuck, end or horizontal mill, drill, saw with blade up to 14", grinding wheel, sanding discs — can be attached to the end of the spindle, enabling the MultiMachine to do virtually all metalworking operations. The overarm can be replaced with a shaper or slotter.

The worktable (G) is a metal plate bolted flat atop a four-cylinder engine block (H) that sits beside the main block. Each block has a vertical plate bolted to each side (I), and these pairs of plates interlock and serve as a slide mechanism that lets the work surface be raised and lowered by an automotive jack that supports the lower block. After you jack the table, you keep it in place by clamping the vertical plates together. And by applying a bit of jack pressure, releasing the clamps, and tapping the lower block with a hammer, you can raise the table just a few ten-thousandths of an inch, a level of precision that Delany calls "amazingly repeatable."

## LOST WISDOM

Developing the MultiMachine, Delany drew from an overlooked source of high-quality practical knowledge that is now his hallmark: how-to articles and books from the 19th and early 20th centuries. Numerous maker publications flourished during this time span, to serve a handy population with limited product options. Many of these books were reprinted by Lindsay's Technical Books, which advertises in the back of hobbyist publications. "Lindsay is a cranky old man like me," Delany remarks. "Several of my best ideas came just from his ads. I could never afford to buy most of his books."

More, Google Books has published full-scan archives of old *Popular Mechanics*, *Popular Science*, and *The Mechanics' Magazine*, and archives of other titles exist elsewhere online. Delany's MultiMachine plans include a DIY design from an 1925 issue of *Popular Mechanics* for a hand-cranked cross-slide to move workpieces across the table (although his own machine uses a commercial version). The plans also show how to make a cutting point for lathing from a broken drill bit (*Popular Mechanics*, 1925); how to make a chuck from an engine flywheel (*Machinery Magazine*, 1916); and how to cut screw threads without a lathe or die by using a stretched spring as a master (*Scientific American*, 1910).

Unfortunately, Delany also had an accident while building his MultiMachine. The suspended engine block came loose and knocked him through a window, seriously injuring his back. Now he describes himself as "a crippled inventor guy — the kind that rides a scooter in the supermarket."

## THE PHOTOGRAPH

Around the same time that Delany suffered his back injury, a friend told him about the fateful photograph, which showed a missionary with a farmworker in the developing world. The farmworker held a machete with a blade that looked only about 4" or 5" long, and Delany's heart went out to him for having to rely on such a meager tool. As an inventor with a lifetime of practical machine experience, he realized that he wanted to help.

Old car parts and scrap metal are available in much of the developing world, and if you build your own practical machine tool, then



you will know exactly how to use, modify, and fix it. A MultiMachine outfitted with a chop saw blade and a grinding wheel could turn car leaf springs, or even body panels, into ample and effective machete blades for farmers everywhere. Even if you make just \$2 a day, you can use the machine to start your own business and to make more tools, empowering yourself and your community.

And so, from his home in Texas, Delany entered the world of Appropriate Technology. He tried contacting dozens of large nongovernmental organizations involved in development work, as well as some university engineering departments in Texas, to tell them about the MultiMachine and its potential for the developing world. Even the simplest version of his machine, he noted, can resurface brakes and clutches, a job that needs doing anywhere there are cars. But Delany's front-door knocking proved unfruitful. "The NGO people had no interest in anything technical, and the university people seemed to be afflicted with 'not-invented-here' syndrome," he recalls.

## OPEN-SOURCE HARDWARE

Having struck out finding institutional backing, Delany went the DIY route. He started a MultiMachine Yahoo Group in 2004 to collaborate on open-source machine plans, and it started to gain a following. Many others, in a broad range of ages, also wanted to build their own radically cheap machine tools and help marginalized communities around the world free themselves from poverty and dependence. He was encouraged to pursue his vision. In one forum thread from April 2005, Delany responded to a message from member George Ewen by writing:

*It's strange, but at my advanced age I realize that machine tools are about all that I believe in. The lathe, shaper, and mill built the foundation of our current standard of living and there is no reason why a cheap and easy-to-build multipurpose tool could not help the 500 million people that need simple water pumps or the billion people who live on a dollar a day or less. Thanks for getting a crazy old man started.*

He also sees great empowerment potential for DIY metal casting, which he has tried in his backyard. Build a charcoal fire, intensify it with a blower (Pat used a Shop-Vac), and you can melt common zinc-aluminum alloys such as ZA-12 and ZA-27 in a steel pot. Pour into a wet sand mold, and your castings will be easy to machine and nearly as strong as cast iron. With a simple metal casting setup, a MultiMachine, and access to scrap metal, Delany notes, you can do an enormous range of useful metalwork.

## THE MACHINE GOES WIDE

From 2005-2007, Delany's MultiMachine project and online forum continued to gain attention and activity, with surges following coverage on the MAKE and Boing Boing sites and in *Popular Mechanics*. In 2007, he demonstrated the machine at Maker Faire Austin, and when he learned that the first Maker Faire Africa was being planned for August 2009 in Accra, Ghana, he decided to exhibit it there as well. "My only goal is to get the word out," he explains, "and I'm willing to bankrupt myself buying plane tickets."

There he met Noha El-Ghobashy, president of Engineering for Change (E4C), an online forum that enables formally trained engineers and makers to collaborate with NGOs, community advocates, and others on development challenges. "I found Pat to be a bit of an anomaly, given the other kinds of people there," El-Ghobashy recalls, "but it was so fascinating how he uses 19th century technology to address current global needs."

In the Appropriate Technology mainstream, no one was doing what Delany was doing, poring through antique books and magazines and trying out the ideas. But it was a valuable approach, so El-Ghobashy invited him to become one of the early members and contributors to E4C and also asked E4C's main writer Rob Goodier to keep up with and report on Delany's projects. "Engineers tend not to be the best communicators or marketers of their work," El-Ghobashy explains, "Pat uploaded his work to our site, but it needed a push to get the word out."

## THE CONCRETE LATHE

In the meantime, Delany had been recognizing the limits of his original

MultiMachine. It could work as a lathe for smaller work pieces, but it was neither big or powerful enough to bootstrap a factory, nor could it be controlled to reliably cut screw threads, which requires a point to engage with an advancing rod repeatedly in exactly the same place. "The metal lathe is the most necessary tool for industrial development," he explains. "It makes everything that's round, it makes the rollers that make everything flat, and you can use it as a milling machine to make fancy shapes. It all comes back to the lathe."

He had spent years looking for a way to make a large, high-speed lathe out of scrap parts that would be stable, accurate, and hard to throw out of alignment. Finally, he found a clue: a single paragraph in a 1923 issue of *Popular Mechanics* that described concrete-body machine tools used for World War I. One of them was a 10-ton monster lathe that was used to shape artillery shells.

Concrete seemed like a great, inexpensive material for making solid machine tools, but it shrinks as it hardens, which would throw off the alignment of anything that's anchored to it. So, how did the WWI armament factories do it? Delany searched for two years for more specific information about how the concrete lathe was built. Finally, MultiMachine forum member Shannon DeWolfe found the answer in a 1916 article in *Machinery* magazine, which described a concrete-body lathe in which the precision parts were held in alignment by casting them in poured molten metal. Delany updated engineer Lucien Yeomans' 1915 lathe technique by using PVC pipe to create spaces in the concrete for fitting the metal parts and securing them in place with non-shrinking cement grout instead of metal.

But now, Delany's back injury prevents him from being able to build his dream machine, which is enormously frustrating for him. He still has a lifetime of machine knowledge in his head, however, and a capable following online, so he's done what he can to enlist others in supporting the potentially world-transforming project. You too can help. 🍪

+ The lathe project: [makezine.com/delany-lathe](http://makezine.com/delany-lathe).

+ Lend a hand: [opensourcemachinetools.com](http://opensourcemachinetools.com).



Written by Bob Parks

# INKJET MANIAC

PRINTERS ARE BECOMING HARDER TO HACK, BUT ONE ARTIST HAS BECOME A CHEMIST, PROGRAMMER, AND MACHINIST IN ORDER TO GET EXTRAORDINARY RESULTS FROM HIS MACHINES.

Have you bought ink for your printer lately? If so, you probably felt a little annoyed with the manufacturer. For starters, there's the horrendous cost — a full round of inkjet cartridges at Staples runs nearly half the cost of the printer itself. Printers are one of those famous loss-leader products like razors and kerosene lamps; you pay almost nothing for the gadget, then they gouge you on the supplies. Analysts estimate that the three big printer makers — Canon, HP, and Epson — make roughly two-thirds of their revenue from supplies.

But beyond the economics of ink, there's also a lock on creative control. As long as the inkjet has existed, adventurous users have been able to peek under the hood, manipulate

the driver software to create weird effects, manually tweak settings to eke out a higher quality, or even delve into the chemistry of ink itself. But that window's closing. Since the inclusion of embedded microchips on ink cartridges, hacking these beige monsters is increasingly tough. A programmer needs to find the digital code on the cartridge in order to use bathtub ink and software, and that code is now harder than ever to access. Only 15% of users refill ink because of the hassles involved.

So it's interesting to meet a professional inkjet printmaker who faces many of the same technical challenges but has to overcome them in order to stay in business. Someone like Jon Cone, 52, the inkjet pro behind art prints by artists such as David Bowie, Wolf



William Dixon



1



2

Jon Cone

- 1. Jon Cone flips through his large scale prints.
- 2. A 100% pure carbon inkjet print made from seven shades of Cone's Piezography carbon inks. He adapted a 1930s Wollensak to a digital camera to shoot it.
- 3. Three Epson 7880 printers — each has been converted to Cone's Piezography inks using refillable cartridges. Each printer has a different "color" of black and white inks. One is Carbon, another is Selenium, and the third is Neutral.
- 4. Cone in East Topsham, Vt., a town whose population hovers around 1,000.



3



4

William Dixon



# FEATURES



The thick handmade paper is affixed to a carrier sheet. Any lint or stray fibers are carefully removed prior to printing. This sheet costs about \$500.

This triple-thick handmade print is being printed on a 64" Roland printer that has been modified to accept the paper and 12 of Cone's custom inks.

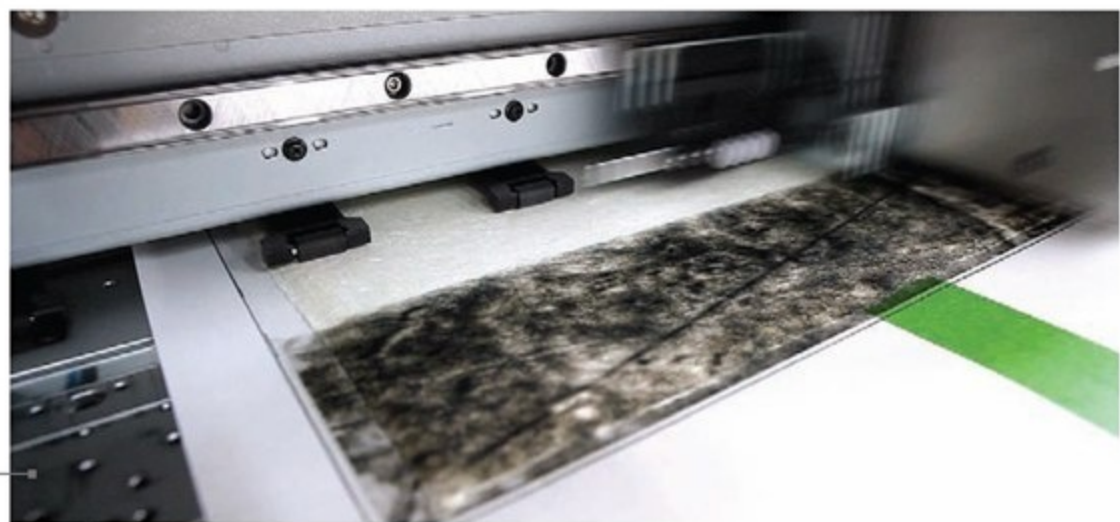

Jon Cone

Kahn, and Richard Avedon. The whole point of printing at the fine art level is to work with the artist to create a signature look.

Drawing on a degree in traditional printmaking from Ohio University's College of Fine Arts, Cone works with artists to manipulate how the ink gets laid down on the page. Then he monkeys with the software to create subtle effects with the high-end paper his clients use — for instance, a recent job called for impossibly thick Japanese handmade paper, each sheet of which weighed 20 pounds and cost \$5,000. "You can't do a test run, you can't see a preview in Photoshop," says Cone. "After a while, you just get the feel of it and you start to think in ink."

Cone's workshop is in the middle of a 17-acre sheep farm deep in rural Vermont. It's a little like a Bond villain's hidden lair — remote, unassuming, and packed with high-tech gear. Inside the converted barn are a dozen wide-format printers perched on glossy hardwood floors. A \$123,000 Iris machine spits out a print that will take several hours to finish. Meanwhile, Cone tinkers on a nearby Roland in preparation to handle photographer Zana Briski's black-and-white work. Briski, the co-director of the Oscar-winning documentary

*Born into Brothels*, wants rich images for this project with a palette tinted the color of tea and the images running over all the edges.

To create Briski's images, Cone changed the firmware inside the device to think it had 12 inks instead of its standard six. To hold the new cartridges in place, he used steel washers and a custom jig he machined on the farm. He even designed the ink itself, had it tested for longevity, and then produced it with a Taiwanese partner (Cone runs a side business selling inks for high-end and consumer inkjets). The 12 different inks will give the image a full range of various levels of gray (a consumer inkjet typically creates gray with one black cartridge). Says Cone, "She wants tons of depth and structure, but if we use too much ink in any one spot it will bleed everywhere."

Cone also printed the images for Greg Colbert's "Ashes and Snow" exhibit, one of the most visited art exhibits in history. Colbert began showing his work on giant Polaroids, but needed a new method once the worldwide supply of 40"×80" Polaroid film ran out. For two years, Cone designed inks, wrote printer driver software, and experimented with various papers to reproduce the otherworldly colors from the Polaroid process. Artists





Dana Ceccarelli, of Cone Editions Press ([cone-editions.com](http://cone-editions.com)), holds up a handmade print of a photo from photographer Andrea Zini.

depend on such heroics because it lets them take an active role in the production of the art.

"When you buy any art print," explains Charles James, a digital printmaker for BowHaus in Los Angeles, "You're looking for evidence of the artist's hand. A collector of Ansel Adams silver gelatin prints wants to know he himself did the dodging and burning and the developing. With digital, you're looking for the same decisions, not what they did in Photoshop but the way they blended the ink and laid down the image on the page."

"Because high-end printers only ship with automatic control, every print can look the same as every other print," grouses James. "But there are people out there who want to push their printer to the limit. I don't understand why the manufacturers haven't embraced this."

To keep their creative experiments going,

A RECENT JOB CALLED FOR IMPOSSIBLY THICK JAPANESE HANDMADE PAPER, EACH SHEET OF WHICH WEIGHED 20 POUNDS AND COST \$5,000. "YOU CAN'T DO A TEST RUN, YOU CAN'T SEE A PREVIEW IN PHOTOSHOP," SAYS CONE.

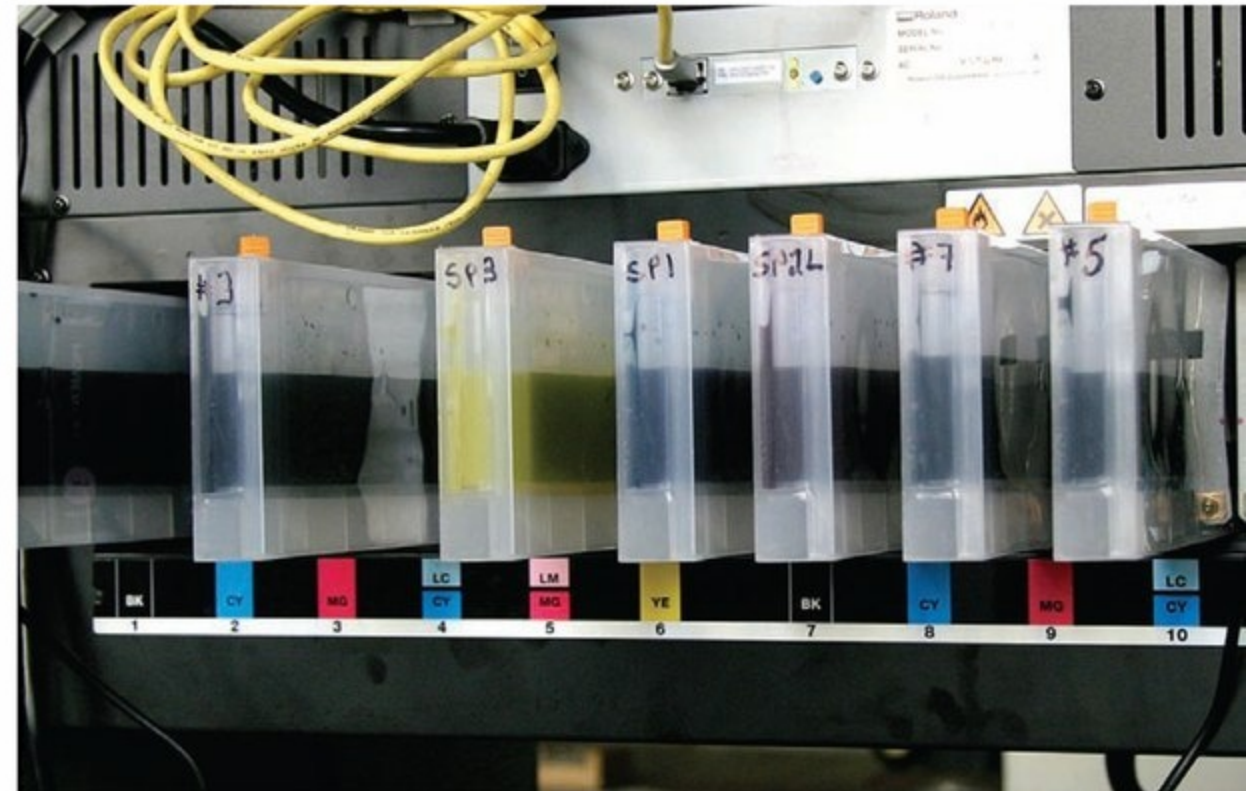

Test carts are filled with inks that Cone made in his studio prior to production. The printer is a 110" Roland solvent printer that has been adapted for use with the pigment inks.

Cone and other printmakers are in a constant cat-and-mouse game with manufacturers. Getting a printer to spit out specialty inks involves creating a software driver that makes the printer think it's using a standard ink tank. But you need the codes inside the cart's microchip to perform this sleight of hand, and sometimes it's not that easy. With a sweep of his hand, Cone gestures to show how he is getting rid of the fleet of newish wide-format Epson printers in his shop, replacing them with Canons. Epson's latest machines are too hard to hack, and he wants to standardize

on a more easily modified platform.

For the technically minded consumer, Cone and others recommend keeping an eye out for well-made vintage printers in junk shops and on eBay. You might even find a few of Cone's castoffs. "Save your old printers," says Roy

Harrington, who codes and sells a driver called QuadTone RIP. "Creativity is more than just hitting the Print button. The older equipment lets you get your hands into their machine and make your image just the way you want it." 🗨️

#### BOB PARKS

is a frequent contributor to *MAKE*, *Runner's World*, and *Wired* magazines. He lives in Vermont with his wife and two children. [bobparkswriter.com](http://bobparkswriter.com)



*Smaller, quicker, and smarter than ever,  
UAVs are taking off fast.*



# **FLIGHT** OF THE **DRONES**

Niagara Falls photography by Nina and Georgi Tushev





The noun “drone” originally referred to a male honeybee. It was first adopted to describe pilotless aircraft (probably) during the 1940s, and has since expanded to include all pilotless vehicles, airborne or otherwise: Today, cars, boats, and

submarines can be “drones,” too. ■■■ As computers and robotics have advanced, “drone” has started to imply a more sophisticated autonomy. The phrase “true drone” has been cropping up, lately, indicating a vehicle that is not only unmanned, but self-

piloting: Tell it where to go, and it simply goes there without further instruction. ■■■ However you feel about the terminology, the technology of unmanned aerial vehicles is fascinating and is generally applicable whether your ambitions lie in the area of “true

drones” or traditional R/C. Given limited space, we have limited our focus mostly to airborne examples, but here, too, many of the same ideas can be applied to drones on the ground, on or under the water, and perhaps even in outer space. ■■■ **Let’s get to it.**





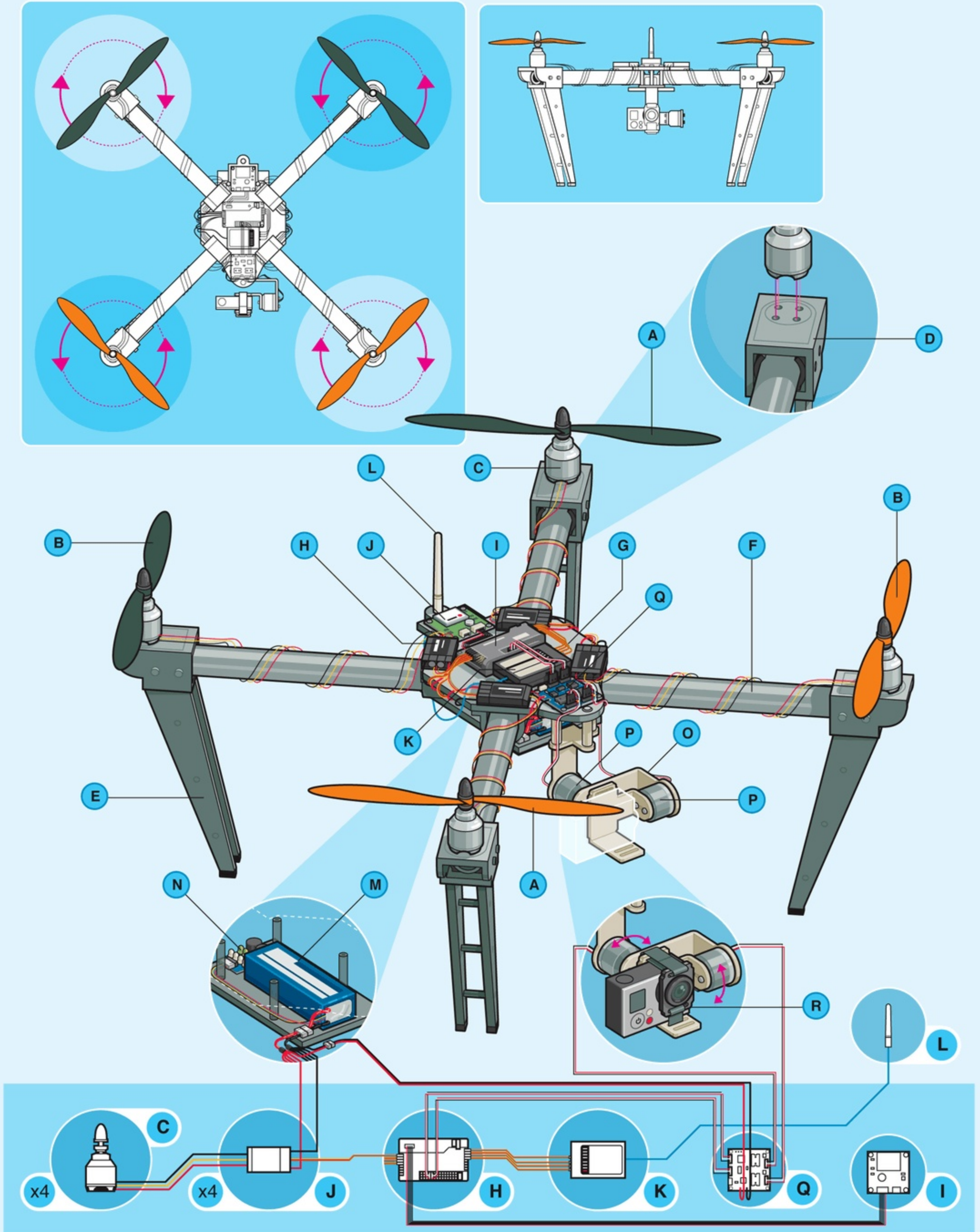



# ANATOMY OF A DRONE

*Finding your way around  
a modern multirotor UAV.*

Illustration by Rob Nance

## **A. STANDARD PROP**

The same “tractor” propeller used on standard front-engine R/C airplanes.

## **B. “PUSHER” PROP**

These contra-rotating props exactly cancel out motor torques during stationary level flight. Opposite pitch gives downdraft.

## **C. MOTOR**

Usually a brushless electric “outrunner” type, which is more efficient, more reliable, and quieter than a brushed motor.

## **D. MOTOR MOUNT**

Sometimes built into combination fittings with landing struts.

## **E. LANDING GEAR**

Designs that need high ground clearance may adopt helicopter-style skids mounted directly to the body, while designs with no hanging payload may omit landing gear altogether.

## **F. BOOM**

Shorter booms increase maneuverability, while longer booms increase stability. Booms must be tough to hold up in a crash while interfering with prop downdraft as little as possible.

## **G. MAIN BODY**

Central “hub” from which booms radiate like spokes on a wheel. Houses battery, avionics, cameras, and sensors.

## **H. ELECTRONIC SPEED CONTROLLER (ESC)**

Converts DC battery power into 3-phase AC for driving brushless motors.

## **I. FLIGHT CONTROLLER**

Interprets input from receiver, GPS module, battery monitor, and onboard sensors. Regulates motor speeds, via ESCs, to provide steering, as well as triggering cameras or other payloads. Controls autopilot and other autonomous functions.

## **J. GPS MODULE**

Often combines GPS receiver and magnetometer to provide latitude, longitude, elevation, and compass heading from a single device.

## **K. RECEIVER**

Often a standard R/C radio receiver unit. The minimum number of channels needed to control a quad is 4, but 5 is usually recommended.

## **L. ANTENNA**

Depending on your receiver, may be a loose wire whip or helical “rubber ducky” type.

## **M. BATTERY**

Lithium polymer (LiPo) batteries offer the best combination of energy density, power density, and lifetime on the market.

## **N. BATTERY MONITOR**

Provides in-flight power level monitoring to flight controller.

## **O. GIMBAL**

Pivoting mount that rotates about 1, 2, or 3 axes to provide stabilization and pointing of cameras or other sensors.

## **P. GIMBAL MOTOR**

Brushless DC motors can be used for direct-drive angular positioning, too, which requires specially-wound coils and dedicated control circuitry that have only recently become commercially available.

## **Q. GIMBAL CONTROLLER**

Allows control of direct-drive brushless gimbal motors as if they were standard hobby servos.

## **R. CAMERA**

GoPro or other compact HD video unit with onboard storage. Real-time streaming is possible with special equipment.



# GETTING STARTED WITH **AERIAL VIDEO**

*How to make fantastic videos  
from your multicopter or drone.*

Written by Eric Cheng



Aerial shot of Vakaeitu,  
Tonga, September 2013.

Julian Cohen





Eric Cheng

**T**he first aerial photograph was taken in 1858 by French photographer Gaspard-Félix Tournachon (from a hot air balloon), and since then, aerial perspectives in imaging have remained elusive to those without astronomical budgets. Historically, photographers have used just about everything to get cameras up in the air including balloons, birds, kites, rockets, airplanes, and helicopters.

In the last few years, unmanned aerial vehicles (UAV) have improved so much in performance and reliability that they have

---

Eric Cheng is an award-winning underwater photographer, aerial imager, and publisher. His underwater images have won contests such as the Nature's Best Photography competition, which has placed some of his work in the Smithsonian's Natural History Museum.

---

started to creep into the mainstream as the best way for (most) people to capture aerial images and video. These 5 tips will help you to get the best aerial videos you can.

### **1. Choose the right UAV**

The vast majority of people getting into aerial videography choose a quadcopter as their first UAV. Quadcopters' electronic flight controllers, sensors, and GPS automatically stabilize flight and in some instances, allow autonomous "mission" flying via waypoint programming, allowing for steady video platforms that can maneuver themselves into precise locations. They're simpler to operate than tricopters, and more affordable than hexacopters.

The most popular quadcopter for aerial



The author's quad of choice, the DJI Phantom, equipped with GoPro Hero3 camera and RotorPixel gimbal.



Eric Cheng

The 3D Robotics Iris



Eric Cheng

The aircraft is crooked but the camera is level, controlled by a brushless gimbal.



Eric Cheng

RotorPixel gimbals are matched to the DJI Phantom and also pretuned to match the GoPro Hero3 camera.

## 2. Choose the right camera

Although large cameras can easily be put into the air if you configure and make your own multirotor aircraft, my favorite cameras for aerial videography are GoPro, which provide the best image quality for their size and weight. The GoPro Hero3 Black Edition weighs only 73 grams and can record video at 2.7K (2,704x1,524 pixels) at 45Mbps (or 30fps). And it's got built-in wi-fi for downloading your footage.

GoPros are also pretty much the standard in aerial videography, which means maximum compatibility with OEM and third-party accessories for aerial imaging, such as vibration isolators and gimbals (covered in the next tip).

Finally, GoPros are easily protected while airborne using their branded underwater housing or third-party lens protectors.

## 3. Stabilize your camera

The smoothness of aerial video is directly correlated to its perceived quality. But

filming is the \$679 DJI Phantom because it's ready-to-fly (RTF) out of the box and is designed to hold a GoPro camera. The Phantom is a great platform, even for beginning hobbyists, because it's easily hackable. There is a vibrant third-party accessories market, mostly made up of enterprising individuals selling personally developed mods online.

Multirotors from 3D Robotics are also a great choice. They offer kits (such as the 3DR Quad Kit, Maker Shed item #MK-3DR01, [makershed.com](http://makershed.com)) and RTF models (including a new Phantom competitor called the Iris), all running their open-

source, open-hardware flight platform for the ultimate in hackability.

Adventurous makers will likely want to build their own multirotor aircraft, which have the advantages of being (potentially) more budget friendly (see "The HandyCopter UAV," page 44) and allowing you to tailor components to your specific needs. A DIY quadcopter or hexacopter consists of an airframe, flight controller, electronic speed controller (ESC), motors, propellers, batteries, radio, and receiver. Entire kits are available for less than \$200. Of course, to do videography, you'll also need a camera, which leads us to...



multirotor motion isn't smooth. As a multirotor flies around, the flight controller automatically stabilizes the aircraft by sending power to its multiple motors. During flight maneuvers or in gusts of wind, a multirotor might pivot violently on multiple axes, which may keep the aircraft itself stabilized in space, but can wreak havoc on footage from onboard cameras. In the past, hobbyists used servomotors to correct for this sort of movement, but servos are slow and sloppy, unable to correct quickly enough.

#### ■ GIMBALS AND AIRCRAFT MOTION:

These days, stabilized aerial video is made possible by the incorporation of gimbals that use brushless motors. A gimbal is simply a support that allows the rotation of an object around an axis, and brushless motors are the same motors that revolutionized R/C model aircraft due to their great power-to-weight ratio (rewound for higher torque in gimbal use).

A typical camera gimbal allows rotation around two axes: roll and pitch. A sensor on the camera mount tells the gimbal controller, "I want to be level," and the gimbal controller sends the appropriate signals to the brushless motors that control pitch and roll. In practice, brushless gimbals yield footage from quadcopters that looks like it was taken using a flying Steadicam (see [ech.cc/aerialvid](http://ech.cc/aerialvid) for some of my footage). Gimbals for GoPro cameras are available for as little as \$150, and can simply be bolted to the bottom of any aerial platform.

#### ■ PROP VIBRATION AND "JELLO:"

The second image-quality problem that needs to be solved is the removal of "rolling shutter" artifacts. CMOS image sensors, which are used in most digital cameras, scan the image in rows from top to bottom as they read data for each frame. If a camera is moved around during shutter sweeps, it results in horizontal spatial artifacts, more commonly known as "jello."

Jello is caused in UAV footage by high-frequency vibrations introduced by rotating motors and propellers. The best way to remove it is by balancing propellers, which can come from the factory with one side heavier than the other. Balancing is facilitated by inexpensive prop balancers,

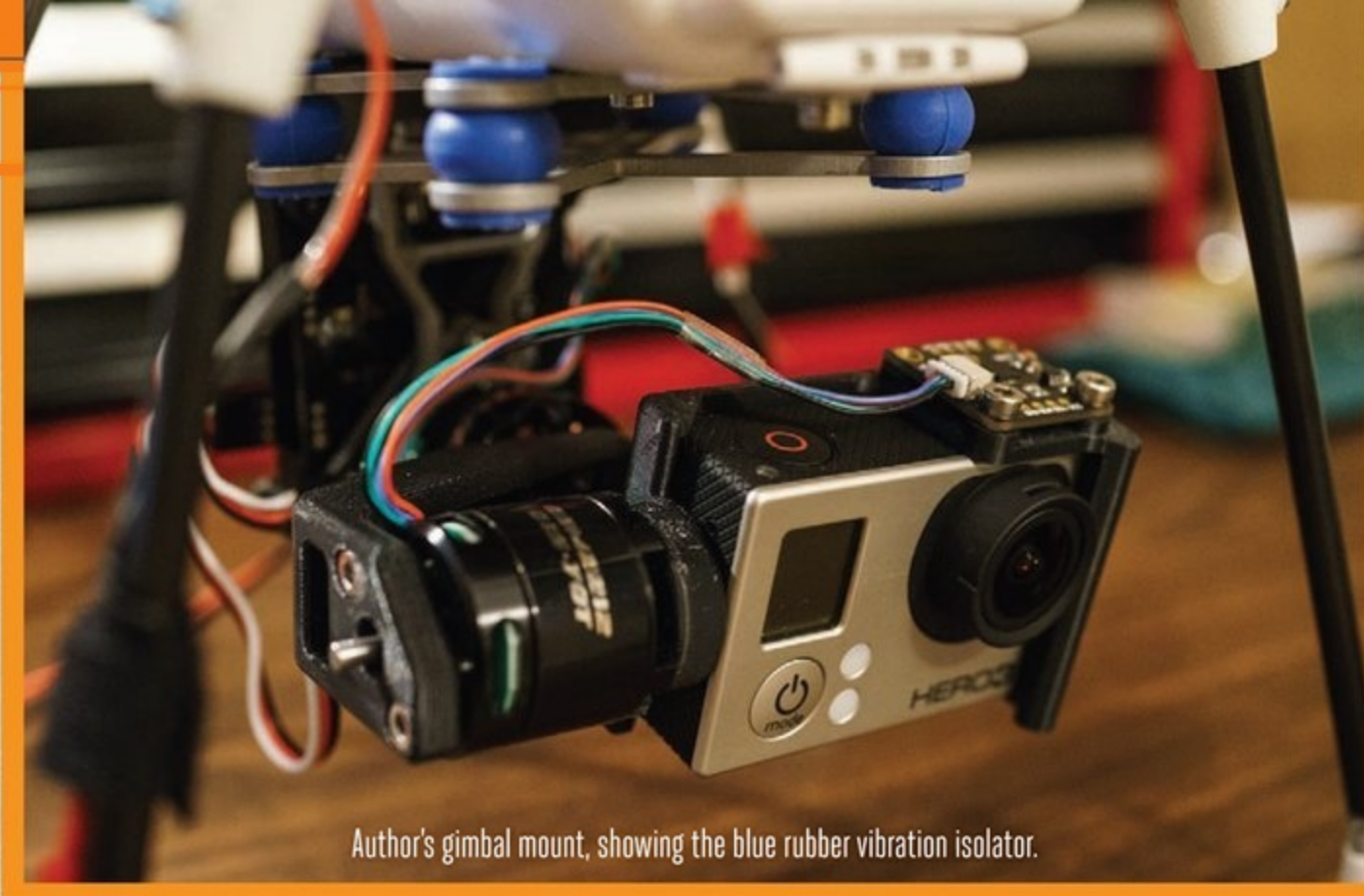

Author's gimbal mount, showing the blue rubber vibration isolator.



Practice your skills with toys like the Blade Nano QX and the Syma X1.

and is achieved by applying clear tape to the lighter side and/or sanding the heavier side. (Sand the flats, not the leading or trailing edges — YouTube has great tutorial videos.)

Balanced props, combined with the vibration isolators that are commonly used to mount gimbals, should yield beautiful, jello-free, stabilized video.

#### 4. Assemble an FPV system

It's difficult to get good video if you can't see what you're recording. With First-Person

View (FPV), an analog transmitter is used on the UAV to broadcast real-time video from the camera. The pilot uses a receiver and either a monitor or LCD glasses to see what the UAV is seeing. Experienced pilots can fly 100% using FPV without needing a line-of-sight view of the aircraft.

An entry-level FPV system can be purchased for around \$250. You can read my full deconstruction of the Ready Made RC 5.8GHz starter kit at [ech.cc/quadfpv](http://ech.cc/quadfpv) — it taps into the GoPro to use it as the FPV camera as well. (For more details on using First-Person View, see "FPV Fundamentals," page 50.)

#### 5. Practice, practice, practice

The most important thing you can do to improve your aerial video footage is to become a skilled pilot. There is no substitute for stick time, and spending all your time at a workbench instead of flying your UAV in an open field will never yield great footage.

I recommend honing your flying skills using inexpensive off-the-shelf toys. The Syma X1 and Blade Nano QX or mQX are all great toy quadcopters that cost between \$36 and \$90. They fly using the same controls, and do not offer the luxury of GPS location hold. If you can master a small quadcopter, the skills you learn will translate directly to larger aircraft. 🚀



Inexpensive prop balancers help you reduce propeller vibration.



# BY **WING, WHEEL** AND **WAVE**

*From the pyramids to the poles, makers all around the world are pushing the envelope with drones and remote-operated vehicles.*

## NEW YORK

Avant-garde dance troupe Pilobolus uses quadrotors to perform "Seraph." During the 10-minute piece, a single performer dances with two LED-adorned drones by Germany's Ascending Technologies, programmed and piloted by students from MIT.

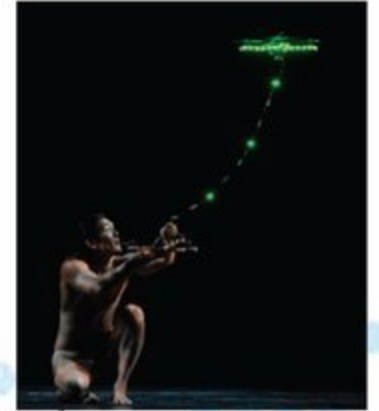

## HALL CITY CAVE, CALIFORNIA

Eric Stackpole and David Lang use the OpenROV submarine to explore an underwater cavern rumored to contain sunken bandit gold. The open-source design was spearheaded by Stackpole and Lang, and developed in part by the 1,000-strong online community at [openrov.org](http://openrov.org).



Chris Gerty

## PROVIDENCE, RHODE ISLAND

Brown University Associate Professor Chad Jenkins leads a team to develop a quadrotor-based telepresence system for quadriplegic Henry Evans. Evans controls the drone using small movements of his head, and uses the onboard camera to explore his surroundings through first-person-view (FPV) flight.



## ANTARCTICA

A NASA-funded team from Carnegie Mellon deploys Nomad, a wheeled rover that automatically combs the frozen ice, detects unusual surface features, and tests them to see if they are meteorites.



## CALAMA, CHILE

A fleet of Komatsu 930E autonomous dump trucks automates mine haulage at the Gabriela Mistral copper mine. The house-sized, diesel-electric behemoths can be programmed from a remote command center to run set paths, avoid obstacles, and recognize other automated vehicles.



## THE NORTH ATLANTIC

A team of seven engineering students launches Scout, a 12-foot-long autonomous boat, to traverse the Atlantic from Rhode Island to Spain. The boat launched in August 2013, but went offline a month later. It had traveled 1,300 miles — about a third of the way across.



## THE SWISS ALPS

Swiss robotics company SenseFly uses fixed-wing aerial drones to create a high-resolution 3D model of the Matterhorn. The team launched the drones from the summit and a second position on the north face and mapped 2,800 hectares during 11 flights with an average precision of 20cm.



## GIZA, EGYPT

Archeologists use a series of drones to explore narrow air shafts connecting the Queen's Chamber to other parts of the Great Pyramid. The most recent drone, the University of Leeds' Djedi, found new markings in a small chamber at the end of one shaft.



## BARDIA NAT'L PARK, NEPAL

The World Wildlife Fund helps train 19 park rangers and Nepal Army soldiers to fly GPS-enabled FPV Raptor UAVs to track poachers in Nepal's national parks. The drones can fly over tough terrain and give patrols a safe view of poachers, who are often heavily armed.



## SYDNEY, AUSTRALIA

Textbook rental company Zookal partners with startup Flirtey to deploy a fleet of six multirotor drones to deliver books to students around Sydney. If approved, Australia would be the first country to allow commercial drone deliveries.





# QUADCOPTER PHOTOGRAMMETRY

*How a trip to Cuba and my love of R/C aircraft aided in the restoration of historic buildings.*

Written by William Grassie • Photography by Mariano Ulibarri

**N**eering the end of my graduate program in media arts and computer science, I found myself stuck working on a thesis I no longer had much interest in. I had lost my motivation and feared I would end up in grad limbo with a project I couldn't bring myself to complete and expectations, including my own, unmet. About this time a friend of mine had signed up for a class that was going to Cuba. This was an opportunity I couldn't miss, so I signed up. This adventure led me to many others, including the genesis of what would become my new thesis.

---

William Grassie is a recent New Mexico Highlands University graduate with a masters in Media Arts and Computer Science. He is an advocate for the positive and productive use of UAVs and is network manager for the Armand Hammer United World College of the American West.

---

I've long been an R/C flying enthusiast. In my boyhood, my dad and I built a small, gas-powered balsa wood plane. It was tethered to a string, and you could only fly in a circle. The poor plane didn't survive its

maiden flight. That concluded my R/C experience for many years, as we couldn't afford to rebuild it. The price of all things R/C at that time made it cost-prohibitive for many.

A couple of years ago I discovered the hobby anew. I purchased a little R/C helicopter for my brother and was surprised by the quality, flight time, and maneuverability. I started doing some research and found a whole new, more affordable world of R/C. This revolution was mainly due to the advent and proliferation of lithium polymer batteries and brushless motors, which replaced expensive, messy gas motors



## Photogrammetry Tips

1. A digital camera with fixed focal length is best.
2. Make sure your photos overlap 60% to 80%.
3. Take the photos horizontal to your object and at a uniform distance.
4. Uniform lighting is important for creating good models.
5. Process the images in Agisoft PhotoScan.
6. Low-quality models can be generated on a laptop. High-quality models require multi-GPU systems with 128GB of RAM.
7. For small models you can get away with 30 to 60 photos. Larger models (like buildings) may require several thousand images. The more photos, the better detail you can achieve.



### MY SETUP

**MULTIROTOR:** Custom built using parts largely from [rctimer.com](http://rctimer.com) with an APM 2.5 controller board from [diydrones.com](http://diydrones.com). It has 30-amp SimonK ESCs (electronic speed controls) and 900kV motors with 10x4.7" carbon-fiber props.

**CAMERA:** Canon PowerShot running CHDK custom firmware, which lets the camera shoot in RAW format and take photos automatically.

and made electric models a more realistic proposition. And so my obsession began.

It started with small helicopters. Then larger helicopters built from parts. This led to airplanes, which was how I began doing FPV (first person view) flying. Soon after came tricopters and quadcopters, which provided full three-dimensional freedom of movement and a very stable platform for cameras.

Then came Cuba, photogrammetry, and liberation from my uninspired thesis. Photogrammetry is a method for creating 3D models of objects by taking a series (usually hundreds) of photographs. The concept is as old as modern photography. What has changed is the use of digital photos and software. The software takes all of the photographs and compares them to find matching points. Then the software uses these points to calculate depth.

Through my graduate program in media arts at New Mexico Highlands University, I traveled to Cuba for photography, photogrammetry, and an exchange of ideas. One goal was to make contact with the Office of the Historian, which is responsible for restoring the buildings of Old Havana.

Highlands University had been working with the Georgia O'Keeffe Museum for about a year developing the use of photogrammetry as a tool for conservation and preservation. We hoped to share these simple and inexpensive techniques with members of the Office of the Historian. We contacted them, learned more about what they do, and demonstrated the methods we had developed for documenting historic objects and sites using photogrammetry. They were very excited and offered us the opportunity to create photogrammetric models of several buildings and structures.

This was my first real opportunity to use photogrammetry in the field, and I too was impressed with what was possible. However, while working on documenting several structures, it became apparent that we were limited by taking photos at ground level, which created gaps in the images. Once we had rendered a preliminary model of Hotel Santa Isabel, I found that anything above the field of view would inevitably show up in the data as black holes rather

than a solid 3D model.

I started thinking of different ways to get a complete view of the building. One obvious method would be to rent a hydraulic lift, but that could be costly and impractical in tight spaces. Helicopters might work but would also be cost-prohibitive. Then it hit me: I could use multirotor R/C aircraft to photograph the inaccessible areas. My passion for photography and the R/C world came together in a beautiful way.

When I returned from Cuba I immediately got to work. I had only recently started experimenting with building quadcopters, and the one I owned had seen better days. But I went ahead and started modifying it to carry a camera for my proof-of-concept build. My initial test used a GoPro Hero HD set for time-lapse and my house as the subject. I shot 200 pictures, and the results, though not beautiful, were very encouraging. I set out to create a purpose-built quadcopter as a stabilized camera platform to create photogrammetric models of large-scale structures.

From the outset, I was determined it would be affordable and accessible, and I hoped my idea could inspire and educate others. In its simplest form photogrammetry can be done with a compact digital camera and a laptop with surprisingly good results. But as the desired quality of the finished model goes up, the hardware requirements and processing time rise dramatically.

Once I had built the new quadcopter, I began testing and collecting data. It worked flawlessly. I collected hundreds of photos to be processed and turned into a complete 3D model of the historic multistory building that was my subject. When the photos had been processed and a complete model had been created in software, I concluded that my methodology was sound and completely viable as a useful tool for photogrammetry of large-scale structures.

In association with the field-testing, I created a blog to help anyone who might be interested in getting started with their own quadcopter. [Uav3-d.info](http://Uav3-d.info) has articles on just about every concept of quadcopter flight so that this technology can be accessed by even the most uninitiated. ☺





# THE **HANDYCOPTER** UAV

*Build your own quadrotor airframe from hardware store parts, then trick it out with stabilized onboard video and autonomous flight.*

Written and photographed by Chad Kapper



Chad Kapper is a veteran video producer with more than 18 years of experience. His passion for film and flight inspired him to create Flite Test ([flitetest.com](http://flitetest.com)), one of the leading brands in the R/C flight industry. For more than 3 years, the team at Flite Test has been entertaining, educating and inspiring the world with R/C flight.

There are essentially two configurations for a quadcopter: the "+" frame and the "X" frame. Here we've chosen to build an X frame so your onboard camera can have a clear forward view. We'll take you all the way from building the airframe to adding autonomous flight capability with ArduPilot. Once you've got it working, you could program this drone, for instance, to automatically visit a series of landmarks or other waypoints and take pictures of them.

### 1. Fabricate the body

The copter's central hub consists of 2 polycarbonate plates. Download the cutting and drilling templates from

[makezine.com/the-handycopter-uav](http://makezine.com/the-handycopter-uav), print them full-size, and affix them temporarily to your polycarbonate sheet. Use a plastic cutter to score and snap each plate to shape, then drill out the holes with a 1/8" bit.

### 2. Cut and drill the booms

Saw 4 square dowel booms to 10"-11" each. Shorter booms will make your quad more agile, and longer booms will make it more stable. Drill two 3mm holes, one 6mm and one 26mm (on-centers) from the end of each boom.

### 3. Assemble the frame

Secure the booms between the hub



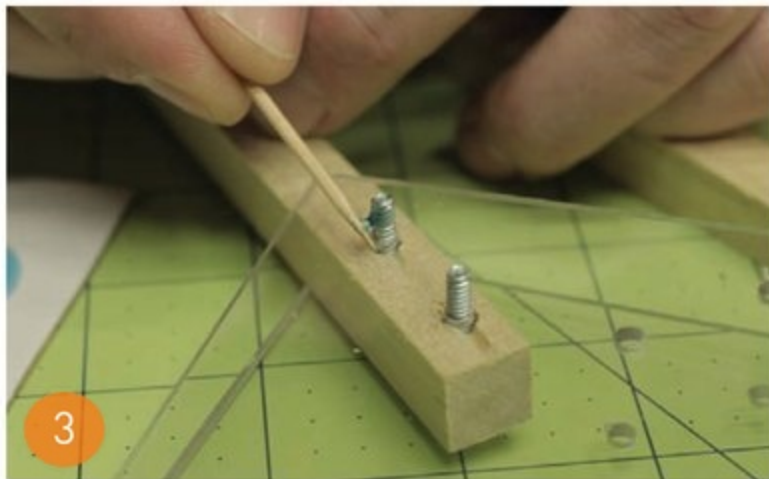

plates using four M3×25mm screws through the inner holes and four M3×20mm screws through the outer holes. Once the booms are in place and you're happy with the fit, apply thread-locking compound to the *outer screws only*, add nuts, and tighten them down. Thread the inner nuts on just loosely, for now.

#### 4. Wire the power hub

Six components will connect to the power hub — the 4 electronic speed controllers (ESCs), the power module, and the gimbal controller board. First, cut off the male XT60 connector from the APM power module cable. Then strip about 1/4" of the insulation from each wire, red and black, on all 6 components, and tin the stripped ends. Saw a 3/8" ring from each end of the copper reducer, and file off any rough edges. Solder each of the 6 red positive leads to the smaller ring, and the corresponding 6 black negative leads to the larger ring. Wrap the smaller ring in 3/8" foam weatherstripping tape and slip the outer ring over it. Finally, paint the entire hub with liquid electrical tape for insulation.

#### 5. Add the motors and landing gear

Here we'll show you how to make your own landing struts from ordinary conduit clamps. You can also use inexpensive prefab combination landing gear / motor mounts that simplify the process quite a bit, and look better to boot. Please check out our product line at [flitetest.com](http://flitetest.com) if you're interested in the prefab option.

**5a.** If you go the homemade route, you'll be mounting the motors directly to the booms. Mark and drill a shallow blind recess in each, so the shaft can spin freely. A 5/16" bit works well for this.

**5b.** Cut down the bracket that came bundled with each motor and use two M3×20mm screws to clamp a motor to the end of each boom. Verify



Wiring the motors and electronic speed controllers together is tedious. Store-bought distribution boards are convenient, but cost space and weight. I prefer this homemade distribution hub made from 2 rings of nested copper pipe to keep things lean and tidy.

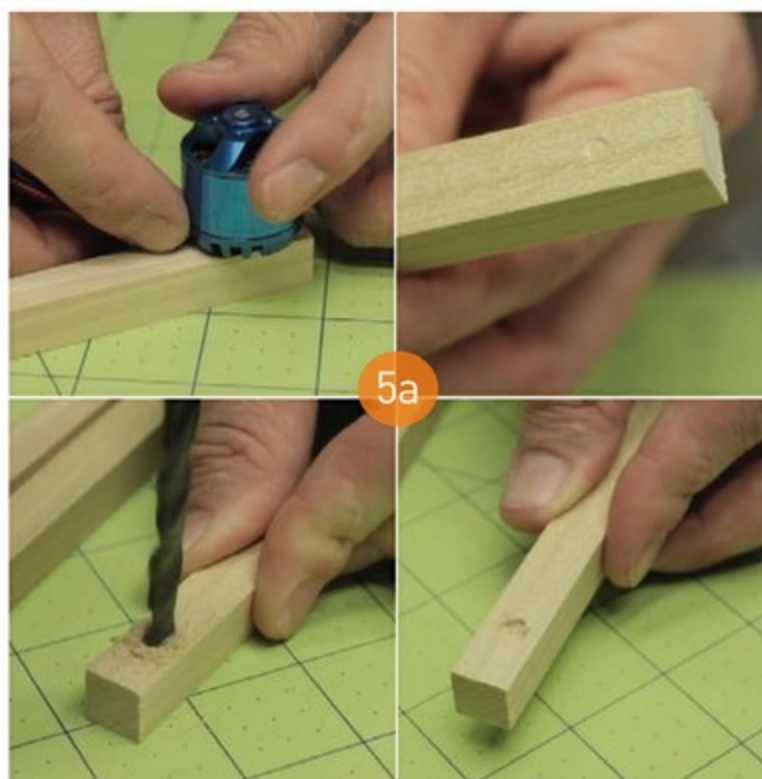

**Time Required:**  
**A Weekend**

**Cost:**

**Airframe: \$30-\$60**

**Avionics: \$500-\$800**

## Materials

### FOR THE AIRFRAME:

- » Conduit clamps, 1/2" (4)
- » Square dowels, wood, 1/2"×36" (2)
- » Machine screws: flat-head M3×6mm (8); M3×20mm (12); M3×25mm (4)
- » Hex nuts, M3 (8)
- » Flat washers, M3 (4)
- » Thread-locking compound
- » Liquid electrical tape
- » Polycarbonate sheet, 0.093"×8"×10"
- » Zip ties, 4" (100-pack)
- » Flexible PVC coupler, 1/4" to 1/4"
- » Aluminum bar, 1/8"×3/4"×36"
- » Hook/loop strap, 1/2"×8" (2)
- » Hook/loop tape, 3/4"×18"
- » Weatherstrip tape, foam, 3/8"×12"
- » Double-sided tape, 1"×5'
- » Wire, stranded insulated, 12 AWG, 12" red and 12" black

### FOR THE AVIONICS:

- » Copper pipe reducer, 1" to 1/2"
- » Gimbal motors (2) iPower 2208-80
- » Gimbal controller iFlight V3.0
- » Flight controller 3D Robotics ArduPilot Mega 2.6
- » GPS module 3D Robotics LEA-6H
- » R/C transmitter, 5+ channels
- » R/C receiver, 5+ channels
- » Motors, 850kV (4) AC2830
- » Propellers, Turnigy 9047R SF (2)
- » Propellers, Turnigy 9047L SF (2)
- » Electronic speed controllers (4)
- » M/M servo leads, 10cm (5)
- » Camera GoPro Hero3 White Edition
- » LiPo battery, 2,200mAh, 3S 20C
- » Battery monitor APM Power Module with XT60 connectors

## Tools

- » Computer with printer
- » Straightedge
- » Plastic scoring knife
- » Drill and bits: 1/8", 3/16", 1/4", 5/16", 3/8"
- » Wood saw
- » Phillips screwdrivers: #1 and #2
- » Pliers
- » Wire cutters / strippers
- » Hacksaw
- » Soldering iron and solder
- » Scissors
- » Pencil
- » File
- » Hobby knife





**5b** Only 2 screws are used on each motor for mounting, and the factory brackets are cut down to save weight.

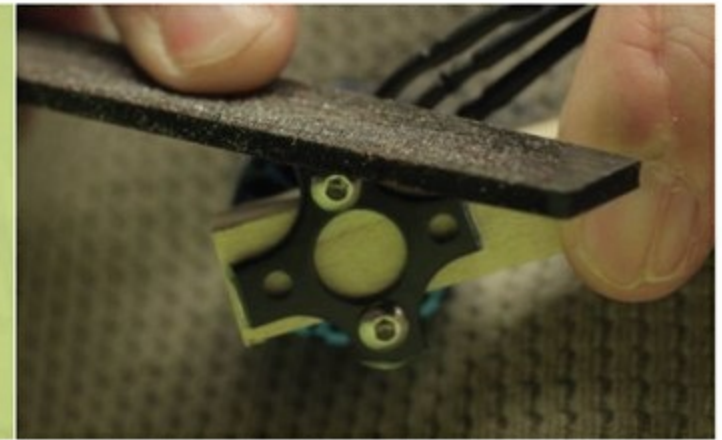
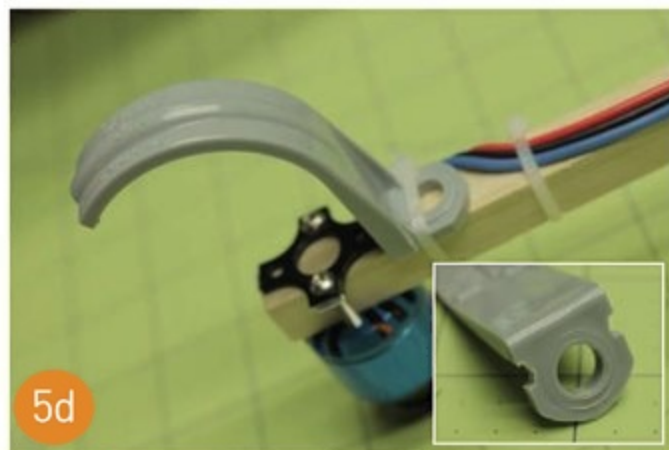
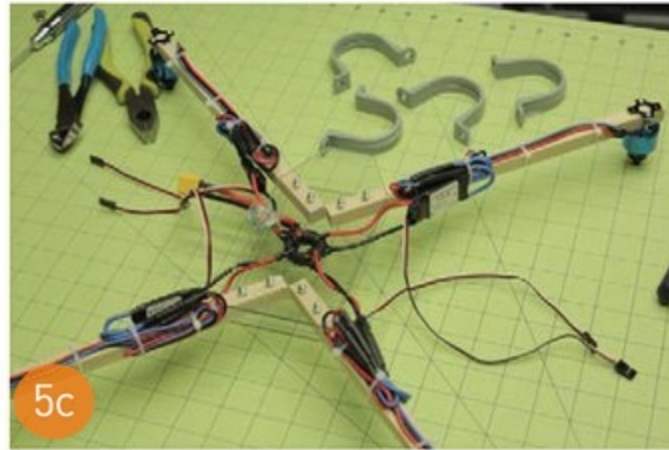
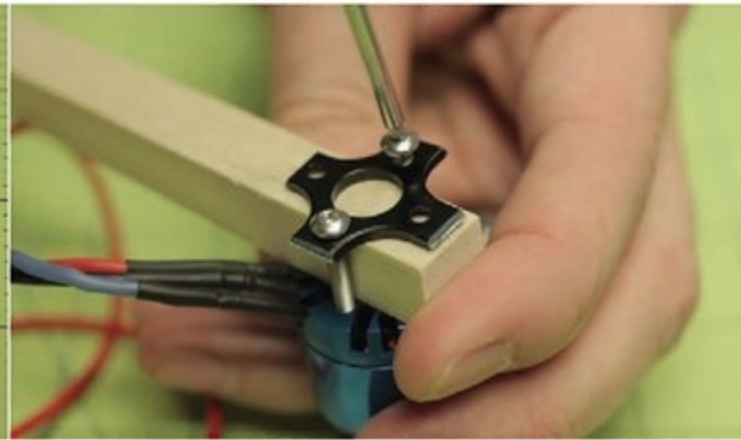

that each motor shaft spins freely when the screws are fully tightened. If not, double-check that its boom is properly recessed underneath. Smooth any rough edges on the bracket with a file.

**5c.** Slip the power hub between the top and bottom body plates and route the ESC power leads out along the 4 booms. If you bought motors and ESCs from the same manufacturer, there's a good chance they came with preinstalled "bullet" connectors. In this case, simply plug the motor leads into the ESC leads and coil any slack under the boom. Or you can solder the motor wires directly to the ESC boards for a cleaner build. Secure the motor leads, the ESC power leads, and any leftover slack tightly against the booms with zip ties.

**5d.** Use wire cutters to snip off one side of each of 4 conduit clamps, leaving a J-shaped foot behind. Smooth the cut end with a file, then file or grind 2 small notches beside the remaining mounting hole as shown. Attach a foot to the end of each boom, just inside the motor mount, using a zip tie run through these notches.

## 6. Install the shock mounts

Remove the hose clamps from the flexible PVC coupler and save them for another project. Cut two  $\frac{3}{4}$ " rings from the coupler's rubber body with a sharp hobby knife. Align each ring across 2 of the frame's protruding inner screws and press down hard with your thumbs to mark 2 drilling spots. Drill

$\frac{1}{8}$ "-diameter holes on the dents, through one side of the ring only. Install the rings over the frame screws with M3 flat washers and nuts. Secure with thread-locking compound when you're happy with the fit.

## 7. Build the camera/battery mount

The gimbal and battery shelf are assembled from three simple L-shaped brackets. We refer to these as the *shelf*, *roll*, and *pitch* brackets.

**7a.** Saw a 36" length of  $\frac{1}{8}$ "x $\frac{3}{4}$ " aluminum bar stock into two 18" sections, then saw one of those into two 9" sections, giving 3

pieces total. Make a right-angle bend in each section as indicated on the templates, working over a piece of wood or other scrap with a beveled edge to increase the bend radius to about  $\frac{3}{8}$ ". [Too sharp a bend can overstress and weaken the aluminum.] After you've made the bends, cut each bracket to final size per the templates.

**7b.** Accurately locate, mark, and drill a centered row of three  $\frac{1}{8}$ "-diameter holes on the short leg of the shelf and pitch brackets, and on both legs of the roll bracket. In each case, the outermost hole should be 3mm from the bracket end on-center, and the holes themselves 9.5mm apart on-centers.

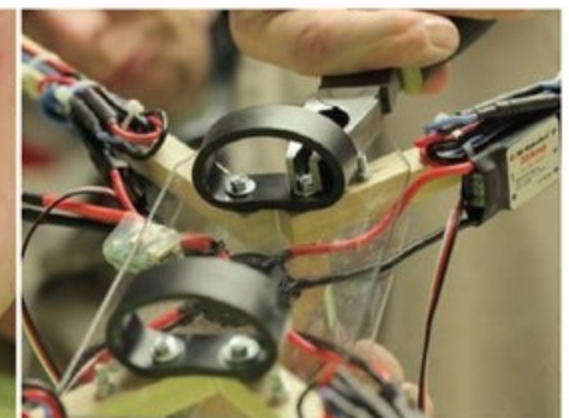

**6** The gimbal and battery shelf are attached via 2 shock mounts cut from thick flexible rubber tubing, which helps isolate the camera from propeller vibrations and adds a bit of space, above, to mount the gimbal controller board.



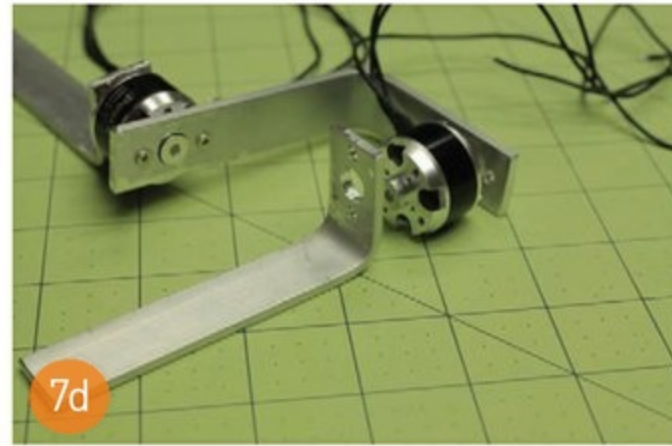

Finally, step-drill the center hole in each row up to  $\frac{3}{8}$ " to provide clearance for the motor shaft.

**7c.** Use two M3×6mm screws to attach the bottom of a gimbal motor to the shelf bracket, and then 2 more to attach the top of the motor to the longer arm of the roll bracket.

**7d.** Attach the bottom of the second motor to the free arm of the roll bracket, and its top to the pitch bracket, in just the same way.

**7e.** For the gimbal motors to operate smoothly, the camera must be balanced along both axes. Weaken the adhesive on a piece of double-sided tape by sticking it to your shirt and peeling it off. Remove the backing and apply the exposed side to the pitch bracket, then use the weakened side to hold your GoPro in place while you adjust it to find the balance point. Once you've got it, use an elastic band or a velcro strap, in addition to the tape, to hold the camera securely in place.

## 8. Mount the camera and battery

I designed this quad to balance properly with a 3S 2,200mAh LiPo battery and a GoPro Hero3 White. If you use other equipment be sure you keep the CG (center of gravity) in the middle of your airframe. Here's how to get it balanced.

**8a.** With the frame upside-down, balance the camera, brackets, and battery across the 2 shock mounts on the underside of the frame. Adjust the position of the whole assembly forward and backward along the frame until the entire quad balances evenly between your fingertips, centered on either side of the body.

### TIP:

Though the GoPro is a tough camera, you may want to build a "dummy" version having the same weight, and approximately the same size, to mount during your maiden and subsequent shakedown flights.

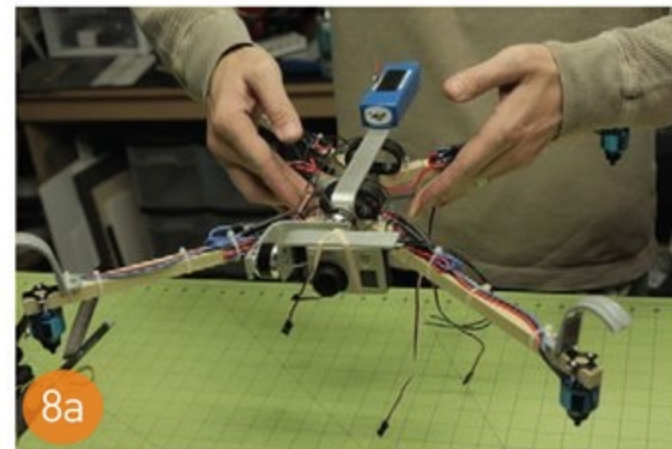

**8b.** Once you've got the CG right, fix the shelf bracket to the shock mounts with 2 sets of crossed zip ties. Apply hook-and-loop tape on top of the shelf bracket and on the underside of the battery, and fix the battery in place. Add a hook-and-loop strap around both bracket and battery as an added precaution.

## 9. Set up the avionics

Arrange your flight controller, receiver and other modules before attaching them to the airframe. Once you're happy with the layout, use double-sided tape to secure everything to the frame. Download the wiring diagram from [makezine.com/the-handycopter-uav](http://makezine.com/the-handycopter-uav) for a detailed list of all connections.

**9a.** Attach the flight controller. In this build we use 3D Robotics' ArduPilot Mega (APM) 2.6, which contains an accelerometer and must be oriented correctly with respect to the frame. Align the arrow on the

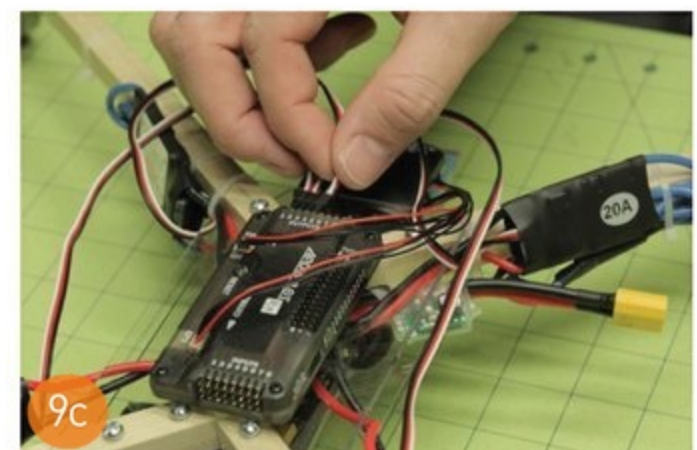
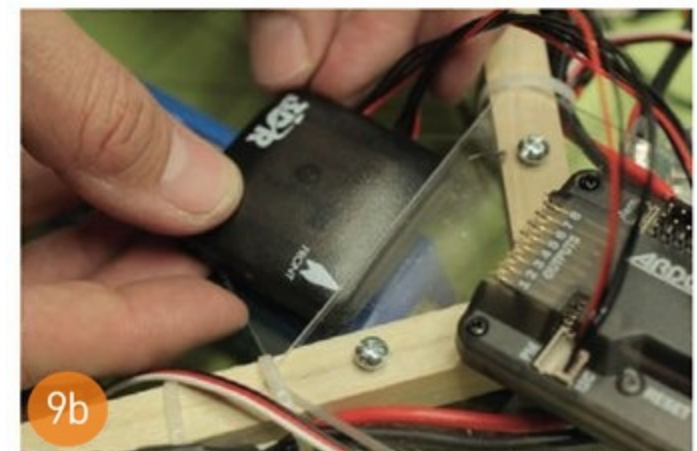

APM case toward the front of the quad and fix it in place with double-sided tape.

**9b.** Add the GPS/compass module, which fits neatly on the rear extension of the bottom frame plate, and also must be aligned with the arrow forward. Tape the module in place and connect the cable to the APM's "GPS" port.

**9c.** Starting from the starboard-front position and proceeding clockwise (viewed from above), connect the ESC signal cables to APM outputs 1, 4, 2, and 3.

**9d.** Mount the receiver alongside the APM with double-sided tape, and connect channels 1–5 to the corresponding inputs on the APM.



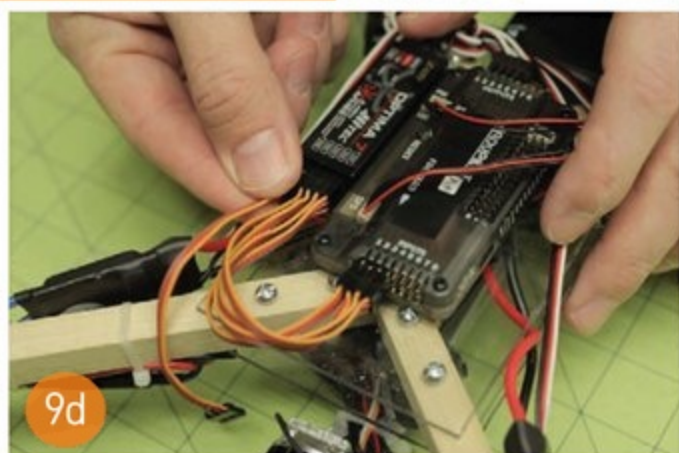

9d

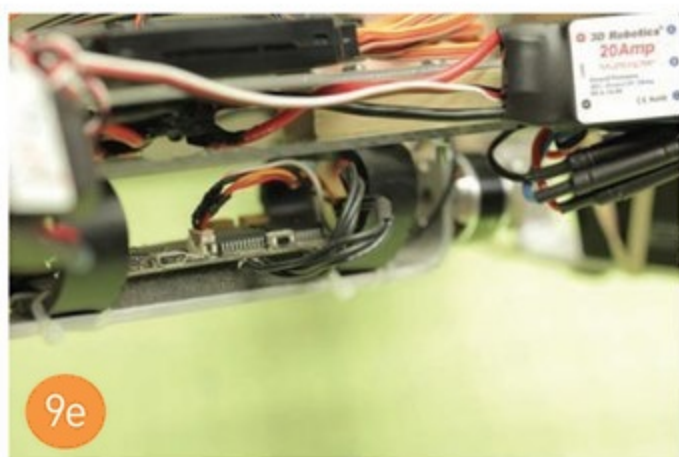

9e

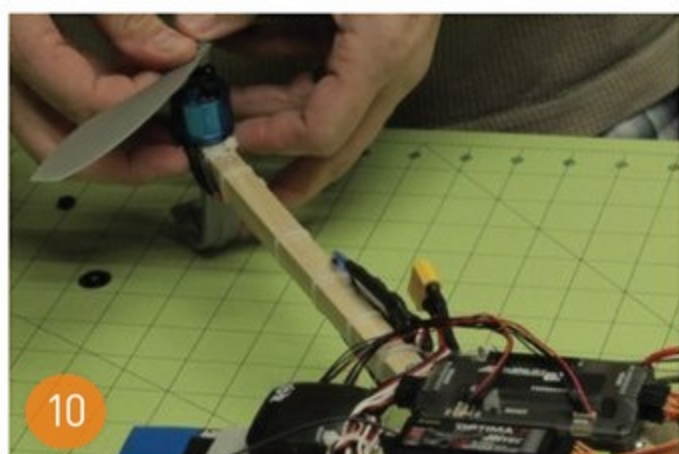

10



David Windestral

**9e.** The gimbal controller consists of 2 boards: the larger controller board and the smaller IMU sensor unit. The controller board goes above the shelf bracket, in the space provided by the shock mounts.

Cover the top surface of the bracket with foam weatherstripping to keep the solder points from shorting against the bare aluminum, then fix the controller board to it with zip ties. The IMU detects the orientation of the camera and needs to be mounted in the same plane; fix it to the underside of the pitch bracket with double-sided tape, and run the connector cable back to the control board. Connect the 3 wires from each gimbal motor to the ports on the controller. Secure all wires with zip ties, leaving plenty of slack for the gimbal to rotate freely.

**9f.** The flight controller, ESCs, and gimbal controller all need to be calibrated and configured before flight. Refer to the bundled or online instructions that came with your equipment. Specific tutorials are available through [makezine.com/the-handycopter-uav](http://makezine.com/the-handycopter-uav).

## 10. Add the props

Before you install the propellers, put bits of masking tape on the motor shafts to make it easy to see which way they are spinning. From above, motors 3 and 4 should spin clockwise, and motors 1 and 2 counter-clockwise (see "Anatomy of a Drone," page 34). If a motor is reversed, simply swap any 2 of the 3 leads connecting it to the ESC.

The most important factor for steady flight is balanced props! There are lots of tricks for doing this, but the simplest involves sanding the heavier side of each blade until the prop balances level on a horizontal shaft. (Sand only the flat, not the leading or trailing edges).

Once the props are balanced, install them on the shafts and tighten the nuts. You'll use 2 conventional airplane "tractor" props and 2 reverse-pitched "pusher" props. Motors 1 and 2 take tractor props, and motors 3 and 4 take pusher props. (If you're not using the APM flight controller, your prop configuration may be different.) Once you've got it right, mark the number and direction of rotation for each motor on its boom for easy reference.

## The Maiden Flight

Make sure the props are balanced, the parts are securely fastened, and none of

the props, gyros, or controls are reversed. Verify that all your radio trim settings are at zero (if you have to trim, do it through the APM, not the radio). Wait for wind-free conditions to actually make the first flight.

Don't expect your quad to fly perfectly the first time. You'll likely need to make some tweaks and adjustments before it flies well. If you've never flown a quad before, remember to work the controls gently,

as most beginners tend to over-steer. Your first goal should be to hover about 24" off the ground for 1-2 seconds and then immediately land. Once you can do that consistently, try to take off, rise above the "ground effect" zone (3'-4'), and then land gently. Work your way

up gradually to longer and higher flights.

It is likely that you will crash at some point, especially if this is your first multirotor. Keep a positive attitude, pay attention, and try to learn something every time. Crashing, learning, repairing, and improving your skills and your machine is part of the fun and challenge of the hobby. 🍷

*Test Builders: Nick Parks, Brian Melani, and Sam Freeman, MAKE Labs*

### WARNING:

If you need to reverse a motor, be sure to swap the motor control leads *only*, not the ESC power hub leads. Don't ever reverse the power connections on an ESC!

For complete parts spec, templates, wiring diagram, and ArduPilot tutorials, go to [makezine.com/the-handycopter-uav](http://makezine.com/the-handycopter-uav)

Share it: [#handycopteruav](https://twitter.com/handycopteruav)



# A <sup>DRONE</sup> OF ONE'S OWN

Five commercial quadrotors ranging from toys to tools.



**Micro UFO Quadcopter**  
\$70 [makershed.com](http://makershed.com)

This is a great starter quad that should still be fun for experts. It has a 6-axis gyro that makes it nearly impossible to flip over, and it's very durable; we've crashed it into trees, grass, concrete — even a pond — and it still runs well. It comes with two batteries, so you can always keep one charging, and ours consistently outperformed the advertised 7-minute mark, giving flights of 10-12 minutes per charge. You don't get an onboard camera at this price point, but otherwise this guy is hard to beat in terms of maximizing fun per unit buck.



**Crazyflie Nano 10-DOF**  
\$180 [makershed.com](http://makershed.com)

At just 19g and 9cm across, this is the smallest commercial quad we know of, and certainly the most indoor-friendly. Assembly is required but it's pretty easy: Solder 8 wires, place the motors, and plug in the battery. You can adapt a handheld transmitter to control it, but the out-of-box flight mode is through a USB radio dongle attached to a computer running the Crazyflie client software. Billed by the designers as "a development kit that flies," everything about the platform — hardware, software, firmware, mechanical design — is fully open-source, so hack to your heart's content!



**Parrot AR.Drone 2.0**  
\$300 [parrot.com](http://parrot.com)

The Parrot sits between basic off-the-shelf R/C quads and more serious offerings. It uses your smartphone as the controller, which is easy for beginners, but maybe not precise enough for pros. An onboard camera streams video right to your device for FPV and/or recording. We did break ours by flying it (hard) into a tree. Luckily, Parrot is extremely fix-it-friendly: Spare parts and quality docs are readily available online.



**DJI Phantom**  
\$480-\$1,200 [dji.com](http://dji.com)

At press time, the Phantom leads the pack among "prosumer" quads. We're not crazy about the manual, but love how it flies: It's fast, powerful, and has a very long range. Onboard GPS provides waypoint hovering and a "panic" function that automatically returns and lands if the transmitter link breaks. Accessibly priced, but the add-ons are spendy (gimbals, landing skids), and after a few flights, you're gonna want 'em.



**3D Robotics Iris**  
\$750-\$1,300 [3drobotics.com](http://3drobotics.com)

Shipping in late December with the new Pixhawk PX4 flight controller, the Iris is a sweet R/C platform, but really shines when flying itself — it can land, take off, loiter, circle, capture video, navigate waypoints, and perform scripted missions on its own. Avionics and software are completely open-source. If you're more interested in "true drones" than hobbycoptering, this is probably your best "one box" bet.



# FPV FUNDAMENTALS

Put a camera on your 'copter  
and yourself in the pilot seat.

Written by Steve Lodefink

**W**atching your rotorcraft or fixed-wing R/C plane fly is always fun, but the experience really comes to life when you get to peer directly through the "eyes" of your aircraft, as if riding along inside it.

In R/C circles, this is called "First-Person View," or more commonly, FPV. It refers to piloting a model aircraft from the perspective of the aircraft itself, via an onboard video camera, wirelessly linked to a ground station, streaming real-time video to be displayed on goggles worn by the pilot.

There are several ways to set up FPV on your rig; this guide should help you understand the general requirements and get you quickly up to speed.

## Camera

The most popular cameras for FPV are small security-type "board cameras," which typically come as caseless circuit boards, with lens assemblies screwed right to the PCBs. It may be tempting to use a cheap, 480-line camera, but for a really satisfying experience, it's best to spend a bit more. \$50 will get you a 600-line board camera from a trusted brand like Sony.

Not only will the higher resolution greatly improve visibility, but these slightly pricier cameras have dynamic exposure features that cheaper models often lack. Most importantly, "Wide Dynamic Range" (WDR) exposure compensation will allow you to see skies and shadowed ground features at the same time, without blown-out highlights or underresolved shadows. This is more than just an aesthetic concern; these features can make a big difference in your ability to navigate.

Besides "board" types, any number of small lightweight commercial video cameras could potentially be adapted for FPV drone use. As long as you can figure out power and signal connections, the only really critical requirement is low weight.

## Mounting the camera

As with shooting photos and video from your drone (see "Getting Started With Aerial Video," page 36), it is especially important to keep airframe vibrations to a minimum when flying FPV. Vibrations cause blurry, nearly useless image transmissions. Balance all props, and if necessary, the bells of brushless motors. Mount cameras using foam, elastic bands, rubber standoffs, and/or other shock-absorbing means to soak up the shakes from the motors and props.

## Ground station

Your ground-based equipment is collectively referred to as a "ground station," and includes the video receiver, antenna, monitor or goggles, battery, and often a tripod, case, or backpack to house everything. Ground station designs vary greatly. A good one will be easy to transport, quick to set up and take down, and difficult to trip over.

## Frequency

A variety of low-cost miniature video transmitters and receivers are marketed with FPV in mind. Common frequencies include 5.8GHz, 2.4GHz, 1.2GHz, and 900MHz. There are several factors to consider when choosing a frequency.

**1) Where do you live?** Different countries regulate the radio spectrum in different

ways. You may want to research your area's laws to avoid legal issues. 900MHz has great obstacle penetration, for example, but may be reserved for phones in the U.S.

**2) Where do you fly?** Different frequencies have different characteristics. 5.8 GHz seems to have good range per watt, but is essentially line-of-sight and will not penetrate buildings or trees. If you fly in open areas, 5.8 GHz might be a good choice.

**3) What frequency do your controls use?** Most R/C radios now operate at 2.4 GHz; to prevent interference, you may want to avoid that band for your video equipment.

## Power

Most entry-level video transmitters radiate 100-500 mW. If you want to fly long-range flights, you may have to get a more expensive, higher power unit. Unlike airplanes, FPV multirotors tend to fly shorter-ranged missions, so you can still have lots of fun, even without a 10-mile range.

## Antennae

The last thing you need when flying FPV is an unreliable video link. The little "whip" antenna that came with your video transmitter is useless. You will want to build or buy a better one. Three or four-lobe omnidirectional "cloverleaf" or "egg-beater" antennas are a good choice and are easy to build and cheap to buy.

Many people also choose high-gain (but also highly directional) planar "patch" antennas for ground station use, and the best-equipped systems employ "diversity" setups that consist of two or more separate





receivers, using different types of antennas, to get the best of both worlds. Special switching circuitry sends you the best available signal at any given time.

### On-Screen Display

An On-Screen Display (OSD) is a little video processor installed in the signal path between the camera and the video transmitter. It takes information from its sensors and injects a graphical data display into the video stream. OSDs range in capability and cost, with the fancy ones featuring compass, GPS, barometers, telemetry, multiple battery voltage monitors, etc.

While usually considered an “advanced” FPV system component, you can get a simple OSD for about \$10 that does one very important thing: monitor and display the battery voltage. Knowing when you are about to run out of juice is pretty important for any FPV rotorcraft pilot.

### Video Display

Some FPV pilots use an LCD monitor. I’ve found that piloting through video goggles makes for a much better, more immersive experience. There are video goggles made specifically for the FPV hobby, notably those by Fat Shark. Some models even have a video receiver built right into the goggles.

I use a pair of MyVu Crystal goggles, which are general-use video glasses

intended for watching video from an iPod, etc. I modified them by adding top and bottom shades of rigid foam, and a strap from a pair of sports goggles.

As with cameras, you need to pay attention to resolution when goggle-shopping. There’s no sense using a 600-line camera with cheap 400-line goggles. As a rule of thumb, you’ll want a pair with at least 640×480 resolution. If you use an OSD, chances are you won’t be able to read the text on the display at a lower resolution. 🚫



Georgi Tushev's head-mounted FPV ground station sports a large flat high-gain "patch" antenna.

Nina and Georgi Tushev



# CUSTOM-GRAFTED MULTICOPTERS

*These open-build designs fly above the crowd. Make one!*

Written by Anna Kaziunas France



## “Roswell Replica” Wooden Quadcopter

Tattoo artist and hobbyist woodworker Greg “Grease” Lehman built an alien-inspired wooden quadrotor based on the original foam-and-paper Roswell Quadrocopter. CNC-cut and -milled from ash, oak, walnut, and padauk, it looks heavy but it flies. Grab EPS files for cutting at [makezine.com/roswellreplica](http://makezine.com/roswellreplica).



## “Crossfire”: 3D-Printed FPV Quadcopter

Mike Bristol is an air ambulance/bush pilot in Alaska who likes drones, FPV “video piloting,” and jumping out of planes. He built the most popular 3D-printed multirotor shared on Thingiverse ([thingiverse.com/thing:32281](http://thingiverse.com/thing:32281)) — and don’t miss his aerial video of BASE jumping off towers ([vimeo.com/79370836](http://vimeo.com/79370836))!



## Laser-Cut MultiWii Quadcopter

Australian surfer and programmer Dylan Fogarty-MacDonald designed and built a hackable, easy-to-repair quadcopter from laser-cut plywood parts. No additional power tools are needed. Assembling it yourself brings the frame cost down to about \$50 (not including motors and electronics). Get the DXF files and full instructions at [makezine.com/lasercutmultiwii](http://makezine.com/lasercutmultiwii).



## Acrylic and Wood CNCed Hexacopter

Designer/fabber Jens Dyvik machined the entire structure of his hexacopter, including the propellers, which he CNCed out of lightweight wood. The body was laser-cut from acrylic, and then formed on an acrylic bender. There’s a second version in the works with wooden arms. Get the 2D and 3D design files from DyvikDesign at [makezine.com/dyvikhexacopter](http://makezine.com/dyvikhexacopter).



# NO MAN'S LAND

*Navigating the legal gray area facing drones and their pilots.*

**7,500.** That's the estimate from the Federal Aviation Administration of how many private drones will be operating in American skies by 2018. Others predict triple that number. Some technologies pose a challenge to law and legal institutions when they hit the mainstream, and aerial drones are among them.

One of the biggest legal issues facing drones is federal regulation. Currently FAA rules disallow any unmanned aerial vehicle (UAV) flight unless (1) the entity secures a Certificate of Authorization (COA) or (2) the individual is a not-for-profit hobbyist operating away from populated areas and below 400 feet. COAs are limited to those testing UAV or using them for a public purpose like law enforcement or firefighting. Operators must keep the UAV in their line of sight and fly below commercially navigable airspace (which varies). And while traditional aircraft generally may not fly lower than 1,000 feet, there is no minimum height for UAV flights.

The FAA recently released a report laying out its basic plan for integrating private drones into domestic airspace as well. It's short on details, but the agency aims to develop a similar COA process for licensing private UAV. Everyone will need to be licensed, I would think, except hobbyists, but we don't know whether this will vary by application or industry. The agency may even revisit its restrictions on hobbyists. Congress requires the FAA to let private UAV operators apply by 2015. However, this doesn't mean that commercial drones will start flying then, only that the preliminary rules will be in place.

I have faith in law's ability to adapt to a new, transformative technology like drones. But the journey could still be a turbulent one.

—Ryan Calo

---

Ryan Calo is an assistant professor of law at the University of Washington, where he teaches a course on robotics law and policy. He is a founding director of the Tech Policy Lab, and in 2013 testified before the U.S. Senate Judiciary Committee on the domestic use of drones. Read his work on SSRN ([ssrn.com](http://ssrn.com)) and follow him on Twitter [@rcalo](https://twitter.com/rcalo)

---

## BATTLE FOR THE SKIES

*Attorney Brendan Schulman describes his case, the first-ever litigation involving the operation of a civilian drone.*

■ Team BlackSheep is renowned for creating spectacular videos of world landmarks using radio-control drones. The FAA is attempting to fine pilot Raphael "Trappy" Pirker for a 2011 flight at the University of Virginia where he was invited to shoot promotional video. The FAA alleges that his 5-pound styrofoam model airplane was a commercial "unmanned aircraft system," and that he flew too close to buildings and people during "reckless operation of an aircraft" — a regulation never before applied to model planes.

We filed a motion to dismiss the case. There are no FAA regulations for the operation of model aircraft, only "voluntary" 1981 guidelines. Nor has the FAA ever before responded to model aircraft mishaps. In 2007, the FAA issued a "policy statement" that purports to ban commercial use of model aircraft and to subject them to federal regulations. The FAA then sent cease-and-desist letters to aerial photography companies, stifling a new technology.

We have argued that the ban is not legally enforceable. The FAA did not conduct the required process to allow the public to comment on proposed rules before they become law. This is not a minor point; it is our democracy at work.

The case has wide-reaching implications: It challenges the FAA's purported ban on commercial drones, and its jurisdiction over small drones flown near the ground. And it may affect whether the United States, the world's aviation leader, will retain that role in the 21st century.



In 2011, Team BlackSheep pilot Raphael Pirker flew this drone over the campus of the University of Virginia. Because of that, today he faces the first-ever legal battle with the FAA regarding civilian drone flights.



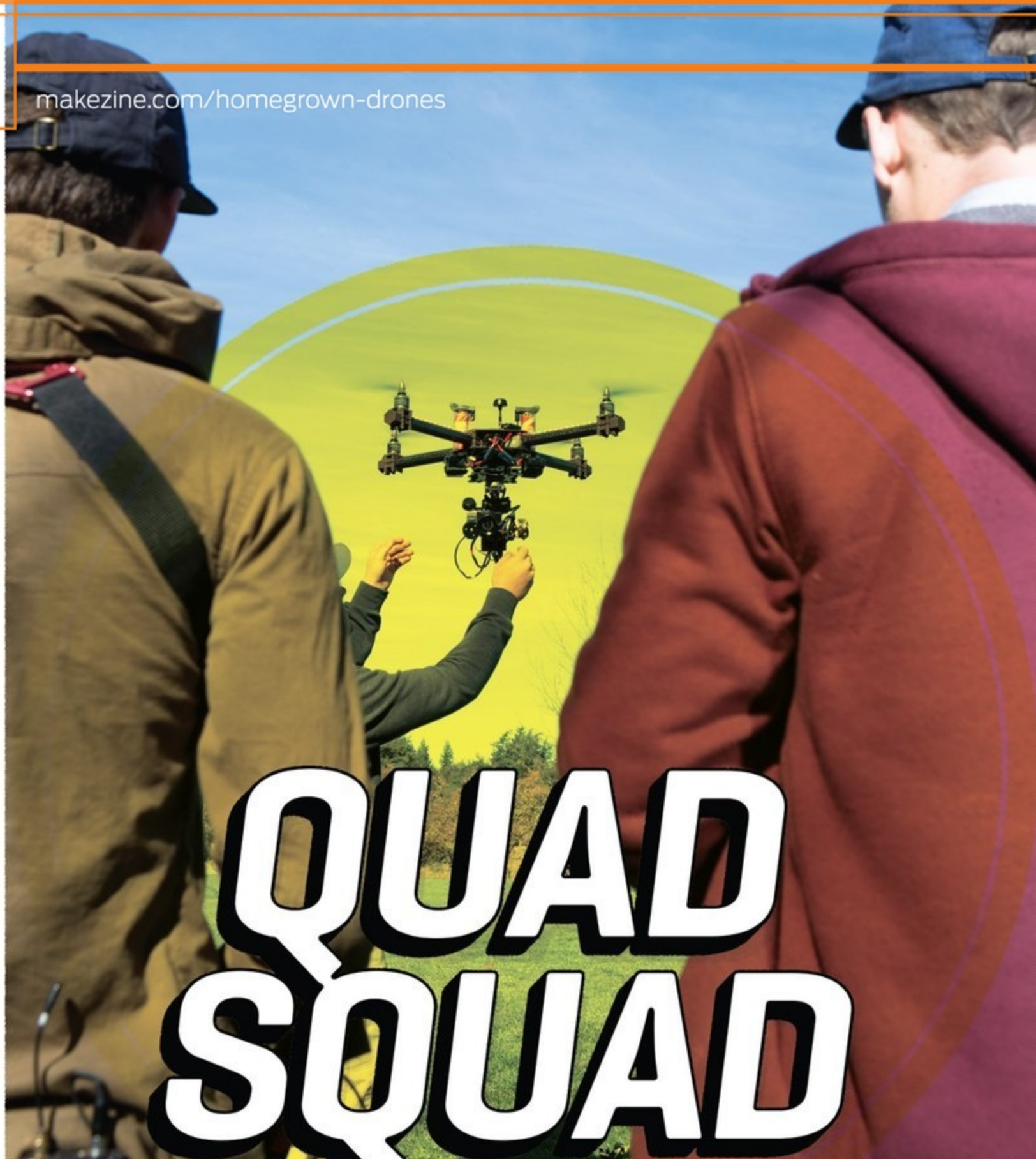

# QUAD SQUAD

*These expert pilots and developers are working to make quadrotors cooler and more useful than ever.*

**E**veryone loves a flying machine. Since launching just over a decade ago, DIY quadrotors and other autonomous aerial platforms have matured rapidly, thanks to an obsessive community and access to technology advancements like lithium-polymer batteries, brushless motors, and increasingly small, high-powered processors and sensors. With these components, drones are now incredibly strong, stable, and capable of doing most if not all of the piloting themselves. ■■■ So if these machines fly themselves, what do enthusiasts do to stay involved and excited? To help answer that question, we assembled a diverse gathering of top UAV flyers, including Hollywood filmmakers, smash-proof airframe builders, and aerial software and component creators, to discuss and demonstrate some of the newest tools and techniques involved in the pursuit of quadrotor aerial excellence. Their reports promise an exciting future in flight.





## Going from 0-60 with APM

Jason Short

Design Director, 3D Robotics

[3drobotics.com](http://3drobotics.com)

APM:Copter was born just over three years ago — on Oct. 10, 2010, to be precise. The date is indelibly etched in my memory, since it was the same day my son Lukas was born. We spent the week at the hospital while the Blue Angels flew overhead during Fleet Week in San Francisco. I knew my days of flying UAVs at the airfield were likely over, so I set about designing one I could fly in my backyard while my son napped.

Adapting APM:Plane to fly multicopter drones was simple at first, but engineering full autonomy turned out to be a wicked problem. Multicopters stress the flight controller system. There are over 100,000 lines of code running on the Arduino-based processor, and almost nothing can go wrong that doesn't end in a bad outcome, often culminating in a crash. Producing a rock-solid flight control system and ironing out the details took a small army of volunteer developers and years of collaborative work, but the results have been astounding.

Today, the 3DR development team is focused on key features that will make it easier for new users to install and configure APM on any airframe.

Our latest software release, APM:Copter 3.1, brings some new and very helpful capabilities. Setup wizards walk you through the configuration process, and a new auto-tune function learns how the drone flies, maximizing flight performance and removing the burden of manual tuning. A new, highly advanced inertial navigation controller fuses GPS and internal sensors to empower a pilot of any skill level to fly the drone right out of the box, without the challenges

inherent to manual flight. Software-defined "geo-fences" prevent you from flying too far or too low. If the drone breaks the fence, APM automatically takes control and flies back home on its own.

A new flight mode called "drift" relies on the intelligence of the autopilot to simplify flight control to a single stick. The end result is a drone that flies and corners more like a race car than a typical multicopter. If you lose orientation, just let go of the stick and the brakes will be automatically applied, bringing your drone to a safe landing.

The most exciting improvement is our new, full-featured Android tablet interface, which enables you to plan and control a drone in the air. Community-developed apps like DroidPlanner and Andropilot allow you to command the drone with a simple Google Maps-like interface.

Advanced features, such as the follow-me function, allow the tablet's position to be sent to the drone, creating your own personal flying camera, ready to capture your next hike up Kilimanjaro, surf in Maui or your son's first successful bike ride in the local park.

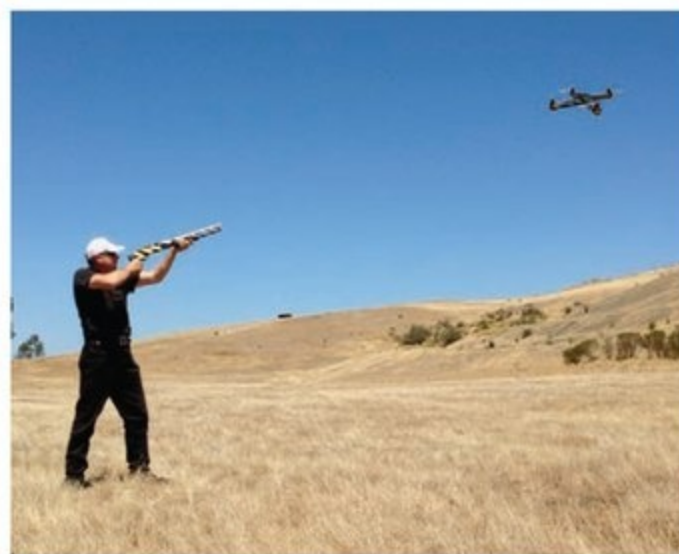

## Building the World's Toughest Drone

Marque Cornblatt,

Co-Founder, Game of Drones

[gameofdrones.biz](http://gameofdrones.biz)

Deep in a huge Oakland, Calif. warehouse filled with fire-breathing robots, monster machines, and other implements of destruction, a not-too-secret cabal of inventors, engineers, and artists meets late at night. This group gathers, first, to show off their latest custom-built drones, UAVs and robots.

And, second, of course, to pit them against each other in one-on-one airborne "fights to the deck."

The crucible of destruction is known, somewhat informally, as "Flight Club." The first rule of Flight Club is that all commercially available drones and drone kits are far too fragile and expensive for heavy-duty use — especially if that use is dogfighting. But a number of innovative and perhaps even groundbreaking design concepts have evolved here, including many clever DIY methods for making drones cheaper, tougher, faster, and easier to repair.

Flight Club competition led me to team up with industrial designer (and long time aerial-dogfighting nemesis) Eli Delia. Together we began researching high-performance materials and manufacturing methods from tough-duty industries including aerospace, military/law enforcement, and even medical manufacturing.

That research led us to thermoformed polymers, and we soon began designing and prototyping airframes using various sheet plastics including styrene, polycarbonate, PET, and Kydex 100, the super-tough plastic "alloy" we ultimately settled on. Launching a Kickstarter let us test the market and get direct feedback from UAV pilots of all skill levels and needs, and this spark of user insight has already ignited several ideas for our next project.

My personal UAV — the one I fly every day — is one of our company's first prototypes. It's been crashed and/or dropped from hundreds of feet too many times to count. It has been flown through fires and landed in (and launched from) stagnant water. We've (deliberately) flown it through plate glass windows and shot it out of the sky with a 12 gauge shotgun. It keeps coming back for more.

Sure, it's scuffed, scratched, torn, and beat, but it still flies straight and true as the day we first launched it. The magic is in the airframe construction, and it's hard to imagine any other type that could withstand such abuse without becoming unflyable.

Besides the super-tough construction, we like to strip our airframes down to the bare necessities. For example, rather than using four ESCs on separate boards, we fa-



vor a 4-in-one ESC board for motor speed control. This reduces the number of failure points significantly. The end result is a super tough, super simple airframe that can survive an entire day of flying, fighting, and crashing without a single repair.

Because most pilots go to great lengths to avoid collisions and crashes, most airframes — though they may be carefully designed to optimize other factors — are mechanically fragile. This has created a culture of expectation in which airframes that break when they crash are an accepted norm. Thus many amateur pilots are rightly afraid to take risks and really hone their flying skills for fear of damaging their frail, expensive gear.

At Game of Drones, our approach flies directly in the face of this culture. Our motto is “Fly ‘em hard and put ‘em away wet. They’re only drones.” It’s my hope that this approach will not only make it easier for beginners to enter the hobby, but will also inspire more people to design, build and fly drones for aerial combat games, business, research, and more.



## Drones as Aerial Access Points

Adam Conway  
VP Product Management,  
Aerohive Networks  
[aerohive.com](http://aerohive.com)

Wi-fi technology will make drones simpler to control and provide the opportunity, eventually, for internet-controlled drones.

While the vision for drones is that they operate fully autonomously taking off, flying a mission and landing without human intervention, of course we will want to be able to find out where our drones are located,

know whether they are functioning properly (or not), and be able to change the mission or take over manual control at any time. Achieving these ends will require maintaining wireless connectivity throughout the majority of each flight.

Wireless communications for hobbyist and pro-level UAVs today primarily consist of three connection uses:

*Control:* Steering a drone in manual mode, or switching into autonomous mode, is typically accomplished with a traditional R/C transmitter and receiver

*Telemetry:* As a drone is flying around it has the ability to send telemetry data back to a ground station. Telemetry data typically consists of onboard sensor inputs including GPS location and diagnostic data, but it can also be used to change settings on the drone mid-flight and provide new mission waypoints. Telemetry data is typically sent over a long-range serial link like IEEE 802.15.4.

*Video:* This is what gets most drone users excited — the idea of sending back real-time video so someone on the ground can experience what it is like to fly. For most hobbyists the only option for getting video from a drone is an analog wireless video transmitter/receiver. Analog video systems offer the advantages of being reasonably low-cost and having very low latency or lag.

With all three of these systems running at the same time there is a risk for interference (with potentially disastrous consequences) so most operators use different frequency bands for each system. Typically drone operators use 900 MHz for telemetry (at least in the US; 433 MHz is standard in Europe), 2.4 GHz for control, and 5GHz for video. Since higher frequency means shorter range, video typically is the weakest link and will go out before an operator loses control or telemetry.

A better solution, however, may be to combine all three systems under a single wireless technology, one that has the range for flight but also the bandwidth to be able to deliver video, control and telemetry with a single radio. For this, wi-fi is the obvious choice: it’s fast, inexpensive, and (if set up properly) has the necessary long range.

In the long view, wi-fi and other TCP/IP-

based networking technologies are going to be foundational for creating drones that are internet-controlled.

Today there are already consumer drones, like the Parrot AR, that use wi-fi for video and control signals. But among the more flexible open-source autopilot software and hardware, support tends to fall off. However, a few eager engineers and hackers have already begun experimenting with adapting ArduPilot for wi-fi telemetry and control, and I think it’s only a matter of time until all drones move to wi-fi.



## Touch-Tablet Drone Control

Andy Brown  
Co-Founder, Fighting Walrus  
[fightingwalrus.com](http://fightingwalrus.com)

For telemetry ground stations, UAV pilots today are basically confined to using Windows-based laptops. The Fighting Walrus Radio (FWR) is designed to expand the options by adding a long-range data link between your personal drone and your iPhone or iPad. It now allows users to collect telemetry and send waypoints, and (in later versions) will add full manual control.

The FWR was born from a collaboration on [diydrones.com](http://diydrones.com), a large online community focused on private UAVs. Australian-based software engineer Claudio Natoli developed a ground station iOS app using hardware licensed for development only, and thus couldn’t be published to the app store. Fighting Walrus co-founder Bryan Galusha (who also oversees the San Francisco Drones Startup Meetup) had been talking with Apple about a made-for-iPod (MFi) drone device since 2008. Bryan connected with Claudio through [diydrones.com](http://diydrones.com), and persuaded him to open-source



his software.

A tablet's portability and touchscreen interface makes it very convenient for map-based use, and we expect tablet flight control to become common. AndroPilot and DroidPlanner are already very popular for Android tablets, which have the advantage of using an open USB interface. iOS and MFi, on the other hand, require a lot more work, but also promise a more seamless user experience.

The FWR connects with small drones like Parrot ARDrone2, but also larger units like 3DRobotics' Iris. Any drone that supports the MAVLink protocol is compatible, including all those that use Ardu-series flight controllers (both ArduPilot Mega and the new PX4 Pixhawk), whether rotorcraft or fixed-wing.

Fighting Walrus was successfully crowdfunded on Indiegogo last spring, and product development now continues with an expanded team of five people. Originally a part-time cofounder with Bryan, I've come on full-time to drastically accelerate development. If you're interested, pre-orders are available now, and the product is on-track for full production in early 2014.



## Hollywood Heights

Jeffrey Blank & Andrew Petersen  
Drone Dudes  
[dronedudes.com](http://dronedudes.com)

We are a unique collective of filmmakers, designers, and flying robots. Using a fleet

of custom multirotor UAVs and custom camera gimbals, we offer our services as aerial cinematographers for feature films, commercials, music videos, and sporting events around the world. We feel fortunate to be supported by a network of amazing people and look forward to seeing where this exciting new technology will take our business and our art.

Our systems provide a cost-effective, safe, dynamic alternative to traditional aerial videography, making them an attractive substitute for producers considering conventional methods like manned helicopters and cranes.

Each UAV is designed with a different camera weight class in mind. Our heavy lifting octocopter was built to mount high-end cameras (like the RED Epic) that can produce the super high-resolution imagery the film industry now expects from professional camera operators. The RED camera, in fact, is the industry standard and flying it was our first big goal.

Now, with pro-quality HD cameras getting smaller and cheaper every day, we believe that the future of cinema drone technology is in a more compact system. Our new UAV design (the D2) comes equipped with everything a professional aerial video team would ever need for a shoot: onboard GPS, a custom three axis brushless gimbal, full HD video downlink, wireless follow focus, and even dual parachutes for those "oh sh\*t" situations. With great agility and response time, we expect the D2 to find a comfy spot at the top of the cinema-drone food chain.

We originally got into flying drones because they can capture shots that are not practical using any other camera platform. Now we've had a glimpse of what's possible, and are striving to constantly develop our technology. The complex, rapidly evolving intersection between technical development and artistic expression is what makes this business so much fun. 🍷

See aerial shots from the Drone Dudes' copter and more from our gathering: [makezine.com/homegrown-drones](http://makezine.com/homegrown-drones)

## Rules of Flight

Flying a UAV makes you a pilot, and like any pilot, you are responsible for the safe operation of your aircraft. The Drone Dudes share their rules of engagement.

- Know your equipment inside and out, and always double-check that everything is in perfect working order before each flight.
- Charge those LiPo batteries inside fireproof bags in a safe location with proper ventilation. Understand the hazards and science of LiPo battery charging, and keep an eye on the cell voltages, yourself, as you charge or discharge your batteries.
- Choose a safe fly zone away from buildings and highly populated areas. Think about what could happen if your aircraft fails mid-flight.
- Understand how changing weather conditions like temperature, altitude and wind will affect your overall flight performance.
- Check your onboard fail-safes and have a coordinated emergency plan with everyone in the flight area.
- Keep a safe distance from subjects and onlookers and always allow for unexpected drift from your plan.
- Keep a clear, safe zone for takeoff and landing.
- Make sure your payload is perfectly balanced on your airframe.
- Fly safe and stay alert. Listen to your gut and fly within your means. Do not let distractions divert your attention and don't hand the controls to anyone without proper training.
- Always fly line-of-sight so you can see what's going on. Do not solely rely on your GPS or flight controller to do the work for you. These tools can fail and you need to be prepared for that. If you are flying in a FPV mode (first-person view), use a spotter with binoculars to keep visual orientation of your aircraft for you.
- It's a good idea to always fly with a telemetry module that can relay live info about your aircraft. Watch your battery voltages for any irregular performance and keep your flight times modest, always flying on the safe side.
- Clear communication is essential. Make sure you have a reliable team supporting you and that everyone knows the predetermined flight path before you take to the sky.



# SKILL BUILDER+

Learning new tricks every issue  
Tell us what you want to learn about: [editor@makezine.com](mailto:editor@makezine.com)

EASY



For makers, it has become quite cheap to incorporate high-quality geospatial data into electronics projects.

And in the last few years, GPS receiver modules have grown much more diverse, powerful, and easy to integrate with development boards like Arduino, PIC, Teensy, and Raspberry Pi. If you've been thinking of building around GPS, you've picked a good time to get started.

## FINDING YOUR WAY with

# GPS

Written by Mikal Hart

### COUNTING STARS

One evening I built a little Arduino/GPS test gizmo to spy on the GPS satellite constellation. I was able to count all 32 distinct satellites over a 24-hour period, with as many as 13 visible at once. For more info:

[makezine.com/gps](http://makezine.com/gps)



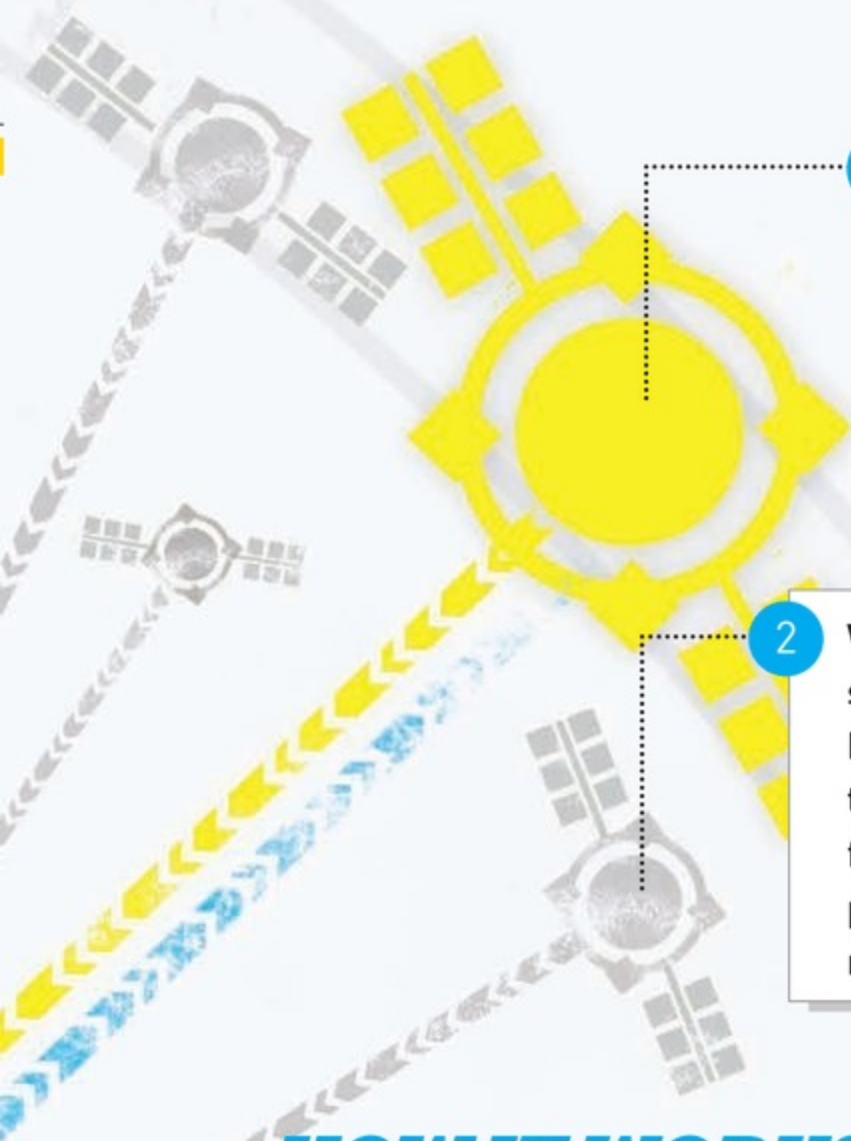

**3** SINCE THE U.S. GLOBAL POSITIONING SYSTEM (GPS) HAS A PUBLISHED GOAL of being usable everywhere on Earth, the system must ensure that at least four satellites — preferably more — are visible at all times from every point on the globe. There are currently 32 GPS satellites performing a meticulously choreographed dance in a sparse cloud 20,000 kilometers high.

**2** WHEN A GPS MESSAGE ARRIVES, the receiver first inspects its broadcast timestamp to see when it was sent. Because the speed of a radio wave in space is a known constant ( $c$ ), the receiver can compare broadcast and receive times to determine the distance the signal has traveled. Once it has established its distance from four or more known satellites, calculating its own position is a fairly simple problem of 3D triangulation. But to do this quickly and accurately, the receiver must be able to nimbly crunch numbers from up to 20 data streams at once.

## HOW IT WORKS

**1** A GPS MODULE IS A TINY RADIO RECEIVER that processes signals broadcast on known frequencies by a fleet of satellites. These satellites whirl around the Earth in roughly circular orbits, transmitting extremely precise position and clock data to the ground below. If the earthbound receiver can “see” enough of these satellites, it can use them to calculate its own location and altitude.

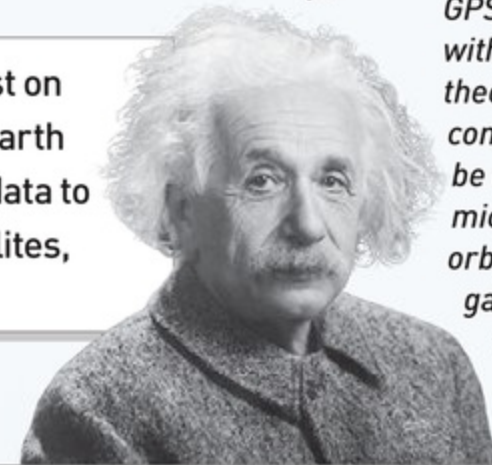

### FUN FACT:

GPS could not work without Einstein's theory of relativity, as compensation must be made for the 38 microseconds the orbiting atomic clocks gain each day from time dilation in Earth's gravitational field.

**Time Required:**  
**2 Hours**  
**Cost:**  
**\$75-\$150**

A quick exercise in understanding and applying GPS data.

**MIKAL HART**  
([arduiniana.org](http://arduiniana.org))

is a senior software engineer at Intel Corp. in Austin, Texas. He is the inventor of the Reverse Geocache Puzzle and a founder of The Sundial Group. He has written about electronics development and prototyping for MAKE and for several books.

Whatever your project, GPS is simple to integrate. Most receiver modules communicate with a straightforward serial protocol, so if you can find a spare serial port on your controller board, it should take just a handful of wires to make the physical connection. And even if not, most controllers support an emulated “software” serial mode that you can use to connect to arbitrary pins.

For beginners, Adafruit's Ultimate GPS Breakout module is a good choice. There are a lot of competing products on the market, but the Ultimate is a solid performer at a reasonable price, with big through-holes that are easy to solder or connect to a breadboard.

First, connect ground and power. In Arduino terms, this means connecting one of the

microcontroller GND pins to the module's GND, and the +5V pin to the module's VIN.

To manage data transfer, you also need to connect the module's TX and RX pins to the Arduino. I'm going to arbitrarily select Arduino pins 2 (TX) and 3 (RX) for this purpose, even though pins 0 and 1 are specifically designed for use as a “hardware serial port” or UART.

Why? Because I don't want to waste the only UART these low-end AVR processors have.

Arduino's UART is hard-wired to the onboard USB connector, and I like to keep it connected to my computer for debugging.

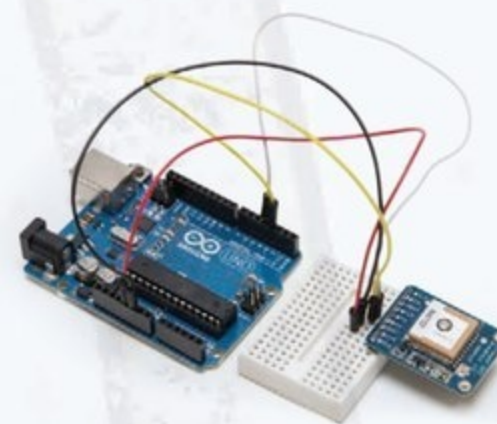

The Adafruit Ultimate GPS Breakout board. A typical GPS interface, assuming both module and main board run at compatible voltages, is as simple as connecting four wires.



### Materials

- » **Arduino Uno** or compatible microcontroller / single-board computer. Maker Shed item #MKSP99, [makershed.com](http://makershed.com)
- » **GPS module** such as Adafruit's Ultimate GPS Breakout. Maker Shed #MKAD47

### Tools

- » **Computer** PC, Mac, or Linux. Laptop preferred.
- » **Soldering iron and solder** may be required to attach header pins to your GPS module
- » **Solderless breadboard**
- » **Jumper wires**

1

```
#include <SoftwareSerial.h>
#define RXPin 2
#define TXPin 3
#define GPSBaud 4800
#define ConsoleBaud 115200

// The serial connection to the GPS device
SoftwareSerial ss(RXPin, TXPin);

void setup()
{
  Serial.begin(ConsoleBaud);
  ss.begin(GPSBaud);

  Serial.println("GPS Example 1");
  Serial.println("Displaying the raw NMEA data transmitted by GPS module.");
  Serial.println("by Mikal Hart");
  Serial.println();
}

void loop()
{
  if (ss.available() > 0) // As each character arrives...
    Serial.write(ss.read()); // ... write it to the console.
}
```

### Sketch 1: A Toe in the Datastream

The instant you apply power, a GPS module begins sending chunks of text data on its TX line. It may not yet see a single satellite, much less have a "fix," but the data faucet comes on right away, and it's interesting to see what comes out. Our first simple sketch (**Figure 1**) does nothing but display this unprocessed data.

#### NOTE:

The sketch defines the receive pin (RXPin) as 2, even though we said earlier that the transmit (TX) pin would be connected to pin 2. This is a common source of confusion. RXPin is the receive pin (RX) from the Arduino's point of view. Naturally, it must be connected to the module's transmit (TX) pin, and vice versa.

Upload this sketch and open Serial Monitor at 115,200 baud. If everything's working, you should see a dense, endless stream of comma-separated text strings. Each will look something like **Figure 2**.

These distinctive strings are known as *NMEA sentences*, so called because the format was invented by the National Maritime Electronics Association. NMEA defines a number of these sentences for navigational data ranging from the essential (location and time), to the esoteric (satellite signal-to-noise ratio, magnetic variance, etc.). Manufacturers are inconsistent about which sentence types their receivers use, but *GPRMC* is essential. Once your module gets a fix, you should see a fair number of these *GPRMC* sentences.

### Sketch 2: Finding Yourself

It's not trivial to convert the raw module output into information your program can actually use. Fortunately, there are some great libraries already available to do this for you. Limor Fried's popular *Adafruit GPS Library* is a convenient choice if you're using their Ultimate breakout. It's written to enable features unique to the Ultimate (like internal data logging) and adds some snazzy bells and whistles of its own.

My favorite parsing library, however — and here I am of course completely unbiased — is the one I wrote called *TinyGPS++*. I designed it to be comprehensive, powerful, concise, and easy to use. Let's take it for a spin.

Our second application continually displays the receiver's location and



2

*GPRMC* is probably the most common NMEA sentence. It contains 12 comma-separated fields, followed by an asterisk (\*) and a checksum to ensure data integrity.



altitude, using TinyGPS++ to help with parsing. In a real device, you might log this data to an SD card or display it on an LCD.

Grab the library and sketch *FindingYourSelf.ino* from [makezine.com/gps](http://makezine.com/gps). Install the library, as usual, in the Arduino *libraries* folder. Upload the sketch to your Arduino and open Serial Monitor at 115,200 baud. You should see your location and altitude updating in real time. To see exactly where you stand, paste some of the resulting latitude/longitude coordinates into Google Maps. Now hook up your laptop and go for a stroll or a drive. (But remember to keep your eyes on the road!)

### Sketch 3: Finding Your Way

Our third and final application is the result of a personal challenge to write a readable TinyGPS++ sketch, in fewer than 100 lines of code, that would guide a user to a destination using simple text instructions like "keep straight" or "veer left."

Every 5 seconds the code captures the user's location and *course* (direction of travel) and calculates the *bearing* (direction to the destination), using the TinyGPS++ `courseTo()` method.

Comparing the two vectors generates a suggestion to keep going straight or turn, as shown in **Figure 3**.



How *FindingYourself.ino* translates your course and bearing into text directions. The sketch can become the starting point for creating almost any type of autonomous or semi-autonomous vehicle.

## CODING WITH TINYGPS++

From the programmer's point of view, using TinyGPS++ is very simple:

1. Create an object `gps`.
2. Route each character that arrives from the module to the object using `gps.encode()`.
3. When you need to know your position or altitude or time or date, simply query the `gps` object.

Download the sketch *FindingYourWay.ino* from [makezine.com/gps](http://makezine.com/gps) and open it in the Arduino IDE. Set a destination 1km or 2km away, upload the sketch to your Arduino, run it on your laptop, and see if it will guide you there. But more importantly, study the code and understand how it works.

### Going Further

The creative potential of GPS is vast. One of the most satisfying things I ever made was a GPS-enabled puzzle box that opens only at one preprogrammed location. If your victim wants to get the treasure locked inside, she has to figure out where that secret location is and physically bring the box there. (See *The Reverse Geocache Puzzle*, MAKE Volume 25.)

A popular first project idea is some sort of logging device that records the minute-by-minute position and altitude of, say, a hiker walking the Trans-Pennine Trail. Or what about one of those sneaky magnetic trackers the DEA agents in *Breaking Bad* stick on the bad guys' cars?

Both are totally feasible, and would probably be fun to build, but I encourage you to think more expansively, beyond stuff you can already buy on Amazon. It's a big world out there. Roam as far and wide as you can. 🚀

Find the codes and full steps at [makezine.com/gps](http://makezine.com/gps)  
Share it: [#makegps](https://twitter.com/makegps)

## THE FOURTH DIMENSION

Though we associate GPS with location in space, don't forget those satellites are transmitting time- and date-stamps, too. The average GPS clock is accurate to one ten-millionth of a second, and the theoretical limit is even higher. Even if you only need your project to keep track of time, a GPS module may still be the cheapest and easiest solution.

To turn *FindingYourself.ino* into a super-accurate clock, just change the last few lines like this:

```
if (gps.time.isUpdated()) {
    char buf[80];
    sprintf(buf, "The time is
%02d:%02d:%02d", gps.time.
hour(), gps.time.minute(),
gps.time.second());
    Serial.println(buf);
}
```



# Calling Out Around the World

Use the Iridium satellite network to communicate with your projects anywhere they can see the sky. *Written by Mikal Hart*

**MODERATE**

**Time Required:**  
1-2 Hours  
**Cost:**  
\$300-\$400

Link three boards to build a global tracking beacon.

## Materials

- » **RockBlock satellite modem**  
Available in noncommercial, commercial, bare-board, and waterproof ruggedized forms from Rock Seven Mobile Services, [rock7mobile.com](http://rock7mobile.com)
- » **Arduino Nano** or compatible 5V microcontroller
  - » **GPS module** such as Adafruit Ultimate GPS Break-out, Maker Shed #MKAD57, [makershed.com](http://makershed.com)
  - » **USB cable** to fit your microcontroller
- » **Breadboard (optional)**
- » **USB external battery pack (optional)**

## Tools

- » **Computer** PC, Mac, or Linux. Laptop preferred.

If you're old enough to remember the pre-cellphone era, you've probably already heard of Iridium (the company, not the chemical element). Deployment of the Iridium satellite constellation began in the early 1990s and, by the time the company launched its globe-spanning consumer satellite phone service in late 1998, had cost an estimated \$5 billion.

It was a disaster. Phones were expensive, bulky, and unreliable compared to ground-based cell services. Iridium LLC filed for Chapter 11 bankruptcy less than a year later and, in 2001, the satellite constellation and other assets were sold off for a scant \$25 million. At one point, there was serious talk of deorbiting the entire fleet of satellites to prevent them becoming hazardous space junk.

Given all that, you may be surprised to hear that the Iridium network is still up and running. You may be even more surprised to hear that plans are underway to launch a second-generation Iridium constellation, starting in 2015, called Iridium NEXT. And whatever the fate of that venture may be, the original satellites are expected to remain in service until the 2020s.

## IRIDIUM FLARES

There are almost 100 Iridium satellites in low orbit. Each has three large polished flat antennae, which frequently reflect fast-moving spots of sunlight onto an area of Earth's surface about 16 km<sup>2</sup>. These "flares" are easily visible to the naked eye, and are entirely predictable. To find out when the next one will happen near you, visit [heavens-above.com](http://heavens-above.com).



## Makers Take Over

Though the U.S. Department of Defense remains a major user of the Iridium network, the big fizzle of the company's original world-spanning private satphone service has resulted in a surplus of unused bandwidth spinning, quite literally, right over our heads. It's a buyer's market, and the tech to access it is now trickling down to hobbyists and entrepreneurs.

British developer Rock Seven Mobile, for instance, recently introduced an Arduino-compatible Iridium satellite transceiver called RockBlock (Figure A). It can't make real-time voice phone calls, but it can send "text messages" using Iridium's short burst data (SBD) service. Outgoing messages of up to 340 bytes can be directed to an email address or a web server as an HTTP post. Incoming messages are limited to 270 bytes and can be received through the same channels.

RockBlock modems are being installed in high-altitude balloons, free-drifting ocean buoys, autonomous boats, and fixed-wing drone gliders, just to name a few. Connected to a low-cost GPS module, an AVR microcontroller, and a power source, the RockBlock becomes a global tracking device. As long as the power supply holds out and the antennae can see the sky, you can track this stack of circuit boards anywhere it goes, anywhere in the world, from anywhere you can access the web.

## Getting Started

Follow the bundled instructions to set up your RockBlock account, then connect the modem to your Arduino, and your Arduino to your GPS module, as shown in Figure B. Visit [makezine.com/iridium](http://makezine.com/iridium), download the sketch *GlobalBeacon.ino* and the necessary libraries, plug in your Arduino, and upload the code.

You'll probably need to take everything outside to get a GPS fix and an Iridium link. Open the Arduino IDE's Serial Monitor window at 115,200 baud and follow along as the code first establishes a GPS fix, then uploads it to the Iridium network, then puts the hardware into low-power "sleep" mode. Left alone, it will "wake up" every hour and repeat this process. Log on to the Rock Seven web portal to read the received messages and set up message handlers.

## Going Further

This is just a simple proof-of-concept system powered by the USB connection. The first step toward a real-world application



The RockBlock Naked Iridium modem costs about \$250 (plus small monthly access and data charges) and lets you communicate with your project, through the web, anywhere on the surface of the planet you can get 100mA at 5V DC.

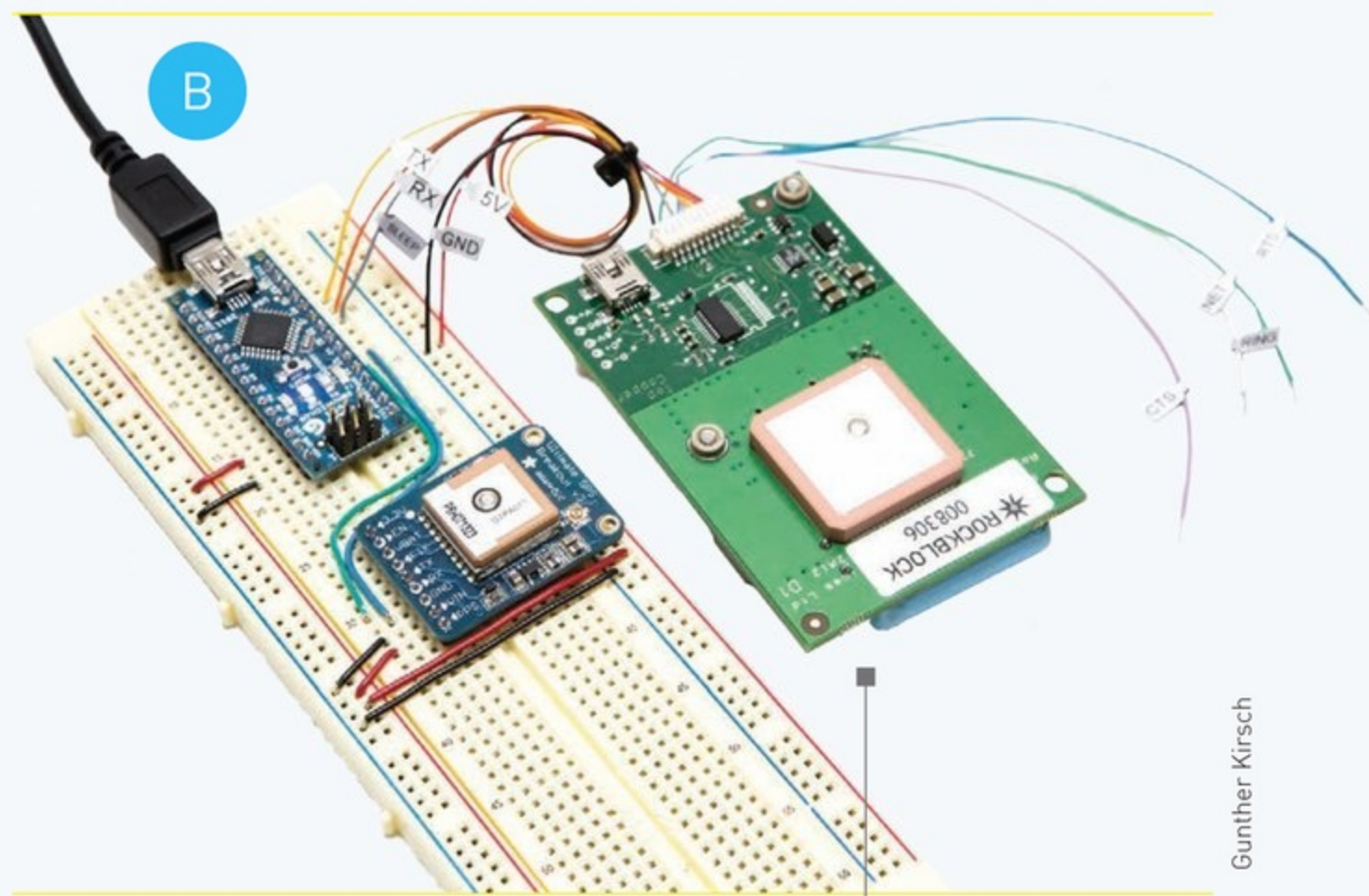

Each RockBlock ships with a 10-pin JST-terminated cable that snaps onto the board and exposes the various signal lines client devices can connect to. The simplest setup, shown here, is what Iridium calls a "3-wire" TTL serial interface, with signal lines for TX, RX, and Sleep. (To connect your Arduino and GPS as shown, see page 59.)

would likely be untethering it from your computer, perhaps with an off-the-shelf USB external battery pack or solar charger.

Don't forget that the RockBlock can both send and receive messages, opening up a world of possibilities beyond basic tracking and monitoring apps. Want a robot that travels to some remote location, reports back on conditions there, and waits for instructions on how to proceed? This technology makes it not just possible to do that, but relatively cheap and easy. The sky — quite literally — is the only limit. 🚀

Get the sketches and steps to start sending satellite messages at [makezine.com/iridiumsatellite](http://makezine.com/iridiumsatellite)

Share it: #iridiumsatellite

Gunther Kirsch



### ELECTRONICS: FUN & FUNDAMENTALS

# Sensor Smörgåsbord

From alcohol vapor to atmospheric pressure, all-in-one sensing devices are smaller, cheaper, and easier to use than ever. *Written By Charles Platt*

## EASY

The mass production first of automobiles, and now of smartphones, has resulted in a surplus of inexpensive sensor modules. Devices are trickling down rapidly into the hobbyist market, with industrial surface-mount components installed on breakout boards for easy soldering. I'm in the process of researching the sensors section for my new book, *Make: More Electronics*, but wanted to take a break and share a few of my most interesting finds.

## Magnetic Fields

### CHERRY MP201701 REED SWITCH \$3 : [jameco.com](http://jameco.com)

One of the most basic, versatile sensors is a magnetically operated switch. The easiest to use is a reed switch, containing two magnetized strips that bend and make contact when exposed to a magnetic field. If you have a home alarm system with pairs of screw-on modules that signal when doors or windows are opened, one module probably contains a magnet while the other contains a reed switch. Many reed switches are contained in thin, fragile glass capsules, but you can also buy them sealed in tough plastic.



### G1994 HALL-EFFECT MAGNETIC SENSOR

\$0.50 : [goldmine-elec-products.com](http://goldmine-elec-products.com)

Reed switches are simple and need no power supply, but they're mechanically fragile and vibration-sensitive. Hall-effect sensors are a superior solid-state alternative. These are found in automotive ignition systems, and can detect position or rotation in simpler applications. For instance, if you mount a magnet on a bicycle wheel opposite a Hall-effect sensor clamped to the frame, a microcontroller can count how often the wheel turns and calculate your speed and distance traveled.

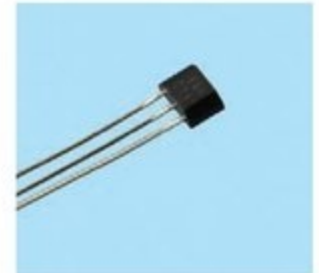

### HONEYWELL HMC5883L ELECTRONIC COMPASS

\$15 : [sparkfun.com](http://sparkfun.com)

How about sensing the Earth's magnetic field to make an electronic compass? Inexpensive modules are available, but be prepared for a learning curve. Magnetic field intensity varies with latitude, and though you can compensate for this with an accelerometer, the method is not exactly trivial. Read up on it first!



## THE OPEN-COLLECTOR SYSTEM

Many all-in-one sensor modules operate on the principle of *open-collector output*. The detecting element in the sensor connects with the base of an internal transistor whose collector is "open," meaning you can access it via one of the external leads.

A typical arrangement is shown in **Figure A**. The positive side of the power supply sinks current through an external pull-up resistor, through the transistor, to negative ground. When the detecting element switches on the transistor, its effective internal resistance falls, and the collector voltage drops. When the transistor turns off, the voltage rises to near the

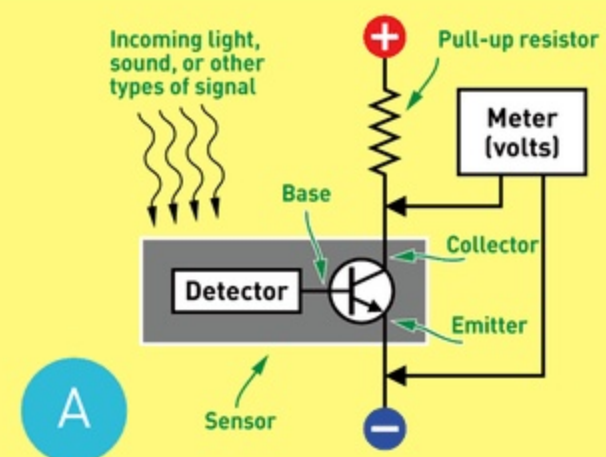

A



## Light & Color

### VISHAY TCRT5000L REFLECTIVE OPTICAL SENSOR \$1 : [mouser.com](http://mouser.com)

IR (infrared) optical sensors are available in a variety of emitter-receiver configurations. A receiver mounted alongside an always-on infrared LED is sometimes referred to as a *reflective sensor*, because light from the LED must go out and be reflected back before the sensor sees it. Any opaque object will bounce the beam, changing the output from the sensor.



### EVERLIGHT ITR9606-F OPTO-INTERRUPTER 70¢ : [mouser.com](http://mouser.com)

IR sensors are also packaged with the emitter opposite the receiver, with a U-shaped gap between them. This configuration may be called an *opto-interrupter*, as it detects objects interrupting the light beam. They are often used in copiers and printers.



### PARALLAX 555-28027 PASSIVE INFRARED MOTION SENSOR \$11 : [parallax.com](http://parallax.com)

Don't confuse emitter-receivers, which are "active" devices, with passive infrared (PIR) sensors. PIR motion sensors respond to variations in the environment created by body heat and are often used to activate lighting for security or energy savings.



### TAOS TCS3200 COLOR DETECTOR \$9 : [jameco.com](http://jameco.com)

If you need to match colors or do white balancing, all-in-one color sensor modules are available that mount 4 LEDs (red, green, blue, and white) around a surface-mount sensor that detects the red, green, and blue components of incident light using photodiodes.



## Gas & Vapor

### MQ-5 PROPANE SENSOR \$7 : [parallax.com](http://parallax.com)

Hanwei Electronics in China builds sensors specific for a wide range of gases including methane, propane, and carbon monoxide. Their propane sensor could be used to detect gas leaks if you're in a rural area where propane heats your home. It runs off 5V AC or DC, and uses a tiny heating element to detect gas.



### MQ-3 ALCOHOL/BENZENE SENSOR \$5 : [parallax.com](http://parallax.com)

An alcohol sensor could be used in a DIY breathalyzer. Beware that the heating element has to be burned in for 12–24 hours before the output stabilizes. Even then, the readings tend to drift a bit, and calibration is a general problem with analog sensors.



### HUMIREL HS1101 HUMIDITY SENSOR \$9 : [parallax.com](http://parallax.com)

Low humidity is bad for my sinuses, so I use an ultrasonic humidifier. I'd like a sensor to switch it on and off, just like a thermostat controls a heating system. Unfortunately the HS1101 provides its output in the form of variable capacitance, which is a bit tricky to measure without a microcontroller.



### ATMOSPHERIC PRESSURE SENSOR MODULE GY-65 \$9 : [dipmicro.com](http://dipmicro.com)

If you're interested in sensing atmospheric pressure generally, instead of particular gases, consider an "electronic barometer" like the Bosch BMP085, shown here mounted in a breakout board module sporting an I2C interface that should be recognized by most microcontrollers.



power supply value (provided the collector isn't connected with a low-impedance device that takes too much current).

Instead of the meter in **Figure A**, you could substitute an input pin to a microcontroller, or the base of another transistor. A PNP transistor will give a positive output from a sensor whose effective internal resistance drops when triggered. The datasheet for a

sensor should tell you its operating voltage and the maximum current it can sink, but won't necessarily reveal the appropriate value of the pull-up resistor. You can find out by starting with 100K and working downward, while checking the voltage (as in **Figure A**) and the current (as in **Figure B**). The current should not exceed the limit stated by the manufacturer.

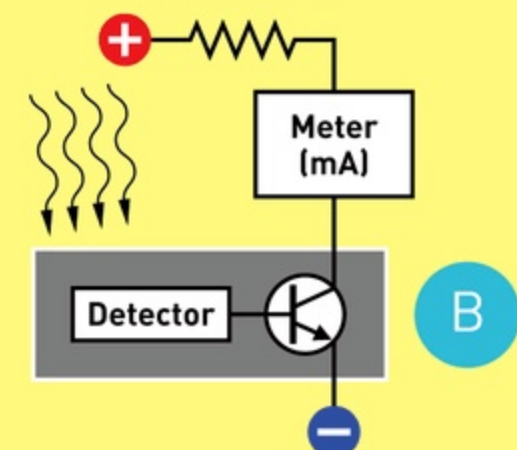



# Luminous Lowtops

Written by Clayton Richter

Take light-up sneakers to the next level with full-color LEDs that respond to your moves.

**Time Required:**

**A Weekend**

**Cost:**

**\$200-\$240**

Stunning show of light and motion leaves other LED shoes in the dark ages.

**CLAYTON RICHTER**

(claytonrichter.com) is a double-major student (electrical and computer engineering, and robotics) at Carnegie Mellon University who enjoys coding, tinkering, and building things. He was born in San Antonio but calls Atlanta home. He's also the creator of the Raspberry Rover (makezine.com/rasprover).







**THE LIGHT-UP SHOES FROM YOUR CHILDHOOD ARE ALL GROWN UP** — these Luminous Lowtops are force-sensitive, full-color LED light-up shoes for adults. Each shoe has two embedded force-sensitive resistors (FSRs) — one under the heel and one under the ball of the foot — and up to 40 RGB LEDs that change color based on the force readings, giving brilliant visual effects when you walk, stomp, jump, or lean.

Not long ago I saw a little boy stomping around a store in his light-up shoes. Admittedly jealous, I searched online for adult light-up shoes. Disappointingly, none of them responded to *how* you moved, only to the fact *that* you moved. Also, most of them required a battery pack to be strapped to the leg or shoe, rather than putting it inside like the kids' shoes do. With those issues in mind, I decided to make the Luminous Lowtops.

The electronics are as simple as possible, to allow everything to fit within the shoe. The LEDs are individually addressable, so each one can be a different color at the same time, allowing the shoes to show shifts in weight and react to your movements. An Arduino Mini microcontroller reads an analog input from the front and rear FSRs, converts these values into colors and maps them to the front and rear LEDs, then calculates a color gradient for all the LEDs in between.

Each shoe is powered by 3 rechargeable AA batteries under the heel, and the components are embedded under the insole for a clean look. The LED strip is securely sewn to the exterior of the shoe, so you can jump, dance, or just gaze at the changing colors.

## 1. Prepare the shoes

There are 2 good mounting options for the batteries and Arduino. Mounting them on top of the tongue of the shoe is easiest, but they'll be more visible there.

To hide the components inside, choose shoes with a thick insole. This allows for some of the padding to be cut out and replaced with the 3×AA battery pack. Rip out the insoles and strip all extra padding off of them, leaving just a thin layer.

Save the extra padding you remove in this step, as you might want to replace some of it later for comfort.



## 2. Attach the LEDs

Using scissors, cut the LED strips to the proper length to wrap around the perimeter of each shoe. The SparkFun and NeoPixel strips can be cut between any 2 LEDs (Figure 2a); just avoid the copper contacts. Cut the Adafruit #306 strip along the lines that appear after every second LED.

Use a needle (with thread that matches your shoes) to sew the LED strip to the shoe. To do this, loop the thread from the inside of the shoe, out through the edge of the LED strip, and back through the opposite edge of the strip into the shoe (Figure 2b). Pull this loop tight and tie a knot.

Repeat this process about once every inch along the shoe's perimeter.

## 3. Drill the shoes

Drill a small hole through the back of each shoe, so that it emerges under the insole. This will allow wires from the Arduino and battery pack inside to reach the LED strips outside.

## Materials

- » **Shoes (2)** ideally with thick insoles
- » **RGB LED strips, 1 meter, individually addressable (2)** SparkFun #COM-12027, 60 LEDs per meter. You can also use the inexpensive Adafruit NeoPixel strips (Maker Shed #MKAD74, [makershed.com](http://makershed.com), 30 LEDs/meter), or the older Adafruit #306 (32 LEDs/meter).
- » **Sewing kit**
- » **Arduino Pro Mini 328 microcontroller boards, 5V, 16MHz (2)**
- » **FTDI Basic Breakout board, 5V**
- » **Force-sensitive resistors, FlexiForce, 100lb rating (4)** from [tekscan.com](http://tekscan.com). Make sure to buy the 100 pound model. If your shoe size is too small to fit the 8" sensor, buy a shorter size for a bit more money.
- » **Resistors, 1MΩ (4)**
- » **Hookup wire, stranded insulated, 22 gauge**
- » **3-pin strip headers, female, 0.1" spacing (2)**
- » **Batteries, NiZn rechargeable, AA size (6)** Normal AA batteries provide 1.2V, but NiZn AAs provide 1.7V, so only 3 are needed to supply 5V, helping them fit in the shoe. You can also try AAAs; they fit into shoes easily, but won't last as long.
- » **Battery packs, 3×AA (2)**
- » **Battery chargers, NiZn AA (2)**
- » **Cotton padding or cotton balls**
- » **Battery packs, 2×AAA (2) (optional)** to hide the Arduino Minis

## Tools

- » **Scissors**
- » **Drill or high-speed rotary tool** such as a Dremel
- » **Wire cutters / strippers**
- » **Soldering iron and solder**
- » **Duct tape** or packing tape
- » **Hot glue gun (optional)** to mount the Arduino
- » **Computer running Arduino IDE** free download from [arduino.cc](http://arduino.cc)



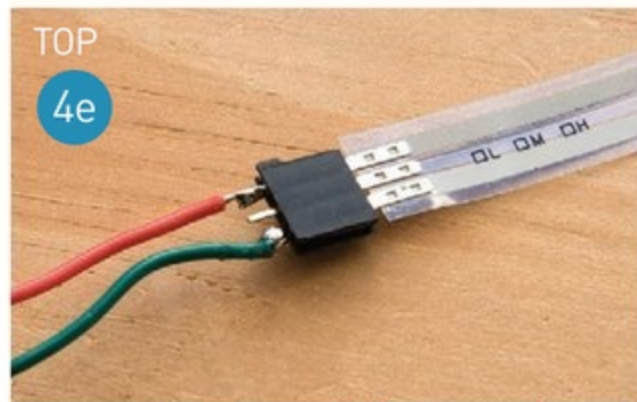
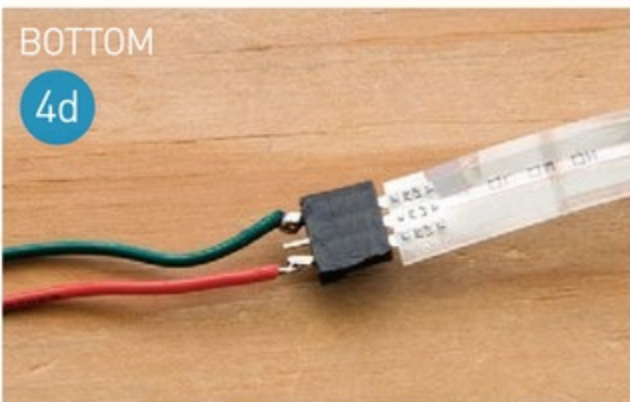
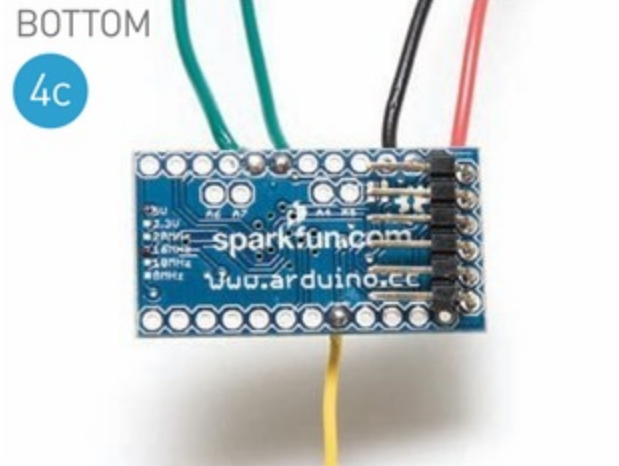
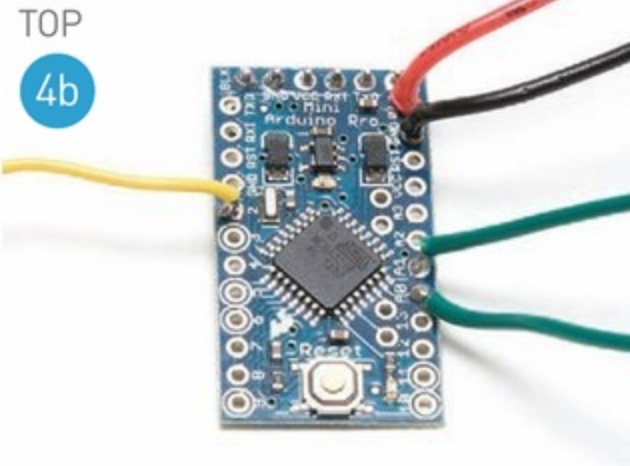
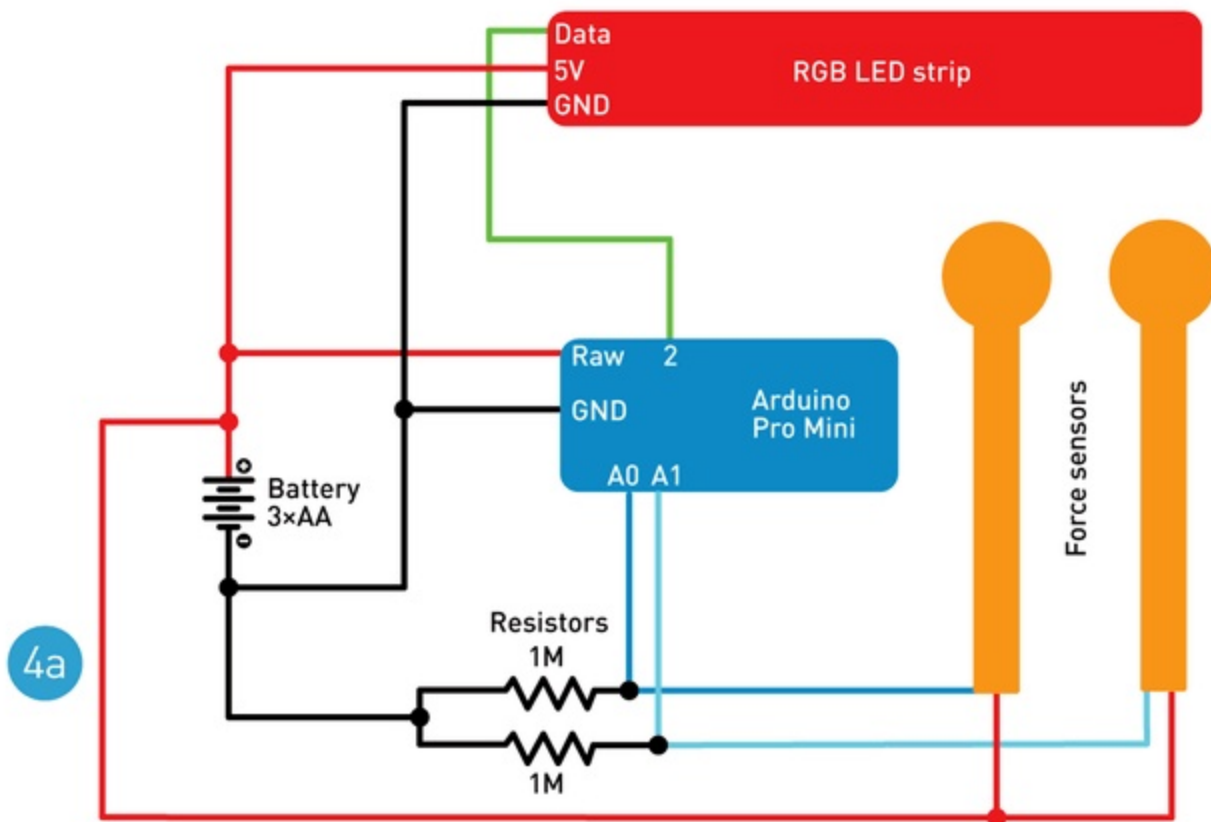

### 4. Build the circuit

Following the wiring diagram (Figure 4a), solder together the circuit for each shoe.

The wires from the Arduino to the LED strips need to be about half the length of the shoe; the wires to the force sensors should be about three-quarters of the length of the shoe. Cut them longer than you think you need; you can always shorten them later (Figures 4b and 4c).

Don't solder directly to the force sensors, as they are plastic and could melt. Instead, solder to a 3-pin female strip header, and then plug the force sensor into the header (Figures 4d and 4e). The middle pin of the force sensors isn't used.

While you're at it, solder the included headers to the FTDI breakout board.

### 5. Program the Arduino

Download the project code from [makezine.com/luminous-lowtops](http://makezine.com/luminous-lowtops) and open it in the Arduino IDE:

- » If you're using SparkFun or NeoPixel LEDs, use the *Neopixel.ino* sketch and download Adafruit's Arduino library for NeoPixel LED strips from [github.com/adafruit/Adafruit\\_NeoPixel](https://github.com/adafruit/Adafruit_NeoPixel).
- » If you're using Adafruit #306 LEDs, use the *8806.ino* sketch and Adafruit's library for LPD8806 LED strips from [github.com/adafruit/LPD8806](https://github.com/adafruit/LPD8806).

Under the Tools → Board menu, choose Arduino Mini w/ATmega328. Also, under Tools → Serial Port, select the serial port that your board is plugged into.

Plug the FTDI breakout board into your computer and plug its header pins into the corresponding 6 pins on the end of the Arduino Pro Mini (Figures 5a and 5b).

Count the LEDs on your shoe and update the `nLEDs` variable in the sketch with that number. (The default is `int nLEDs = 40`.) Click Upload in the Arduino IDE. Unplug the Arduino board.

Repeat for the second Arduino Mini.

### 6. Mount the force sensors

Use duct tape or packing tape to mount 2 force sensors inside each shoe, on top of the sole, so that the circular pad of one force sensor is under the ball of your foot, and the pad of the other sensor is under your heel (Figures 6a and 6b).

Run the wires and resistors flat along the bottom of the inside of the shoe.

### 7. Mount the battery pack and Arduino

Tape the battery pack on top of the heel force sensor so that it fits comfortably under your heel (Figure 7a). I rip out any extra padding under the



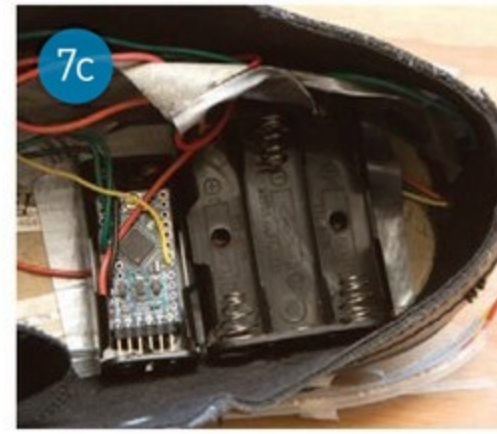
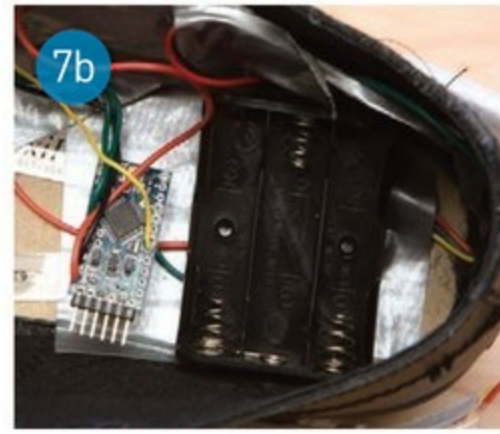

heel first. Most shoes have a hard pad under the heel to lift it; the battery pack essentially replaces this.

The Arduino should lie flat, just forward of the battery pack but tucked close to it, so that the batteries take your weight, not the Arduino (Figure 7b). Cover it with a bit of cotton padding or a cotton ball to protect it and to prevent it from poking you. Once you're sure the shoes are working great, you can seal the Arduino in with hot glue. Or you can stash it in an empty 2xAAA battery pack for extra protection (Figure 7c).

Replace the insole to cover the electronics and battery pack. Though you've thinned it out, it still offers a bit of a cushion.

If your shoes don't have room for these components under the heel, you can mount them on top of the tongue, above the area where your foot flexes (Figure 7d). Again, you can protect the Arduino by hiding it in an 2xAAA battery pack.

## 8. Power up the shoes

Charge the 6 NiZn AA batteries and place them in the battery pack of each shoe.

Put the shoes on, lace them up, and watch as they react when you walk, run, jump, and dance (Figures 8a, 8b, and 8c)!

The basic code loop reads an analog input from the front and rear force sensors (their resistance changes linearly with the amount of force, and they're connected to the Arduino with pull-down resistors). It then takes those force values and scales them to the color space of the LEDs based on some general estimates of the maximum and minimum resistances of the force sensors.

Once the code has calculated the corresponding colors for the front and rear LEDs, a for loop produces a color gradient of sorts for all the LEDs in between.

Finally, the code sends these color values to the individual LEDs.

## Going Further

To improve the fit with the components mounted inside the shoe, try excavating a cavity in the top of the sole to accept the battery pack and Arduino.

Try modifying the `getColorFromForce` function in the code so that the default color (with no weight on the sensors) is your favorite color. You might also save power (and extend run time) by switching the default from blue to red.

You could easily apply the techniques and code from this project to modify other kinds of shoes, like these light-up high heels (Figure 9), or other garments altogether. What about light-up elbow or knee pads? Light-up gloves? Pants? 🍌



Watch Clayton Richter's original Luminous Lowtops in action at [makezine.com/go/lowtops](https://makezine.com/go/lowtops).

Get the code, instructions, photos, and video at [makezine.com/luminous-lowtops](https://makezine.com/luminous-lowtops)

Share it: [#luminouslowtops](https://twitter.com/luminouslowtops)



9







**Time Required:**  
2-3 Hours  
**Cost:**  
\$10-\$20

A simple woodworking project that teaches some new tricks.

**LEN CULLUM**

([shokunin-do.com](http://shokunin-do.com))

is a woodworker living in Seattle, where he specializes in building Japanese-style garden structures and architectural elements. When not woodworking, he teaches at Pratt Fine Arts Center, writes, and dreams of a robot that would sharpen his chisels.



# Salt and Pepper Well

Simple and elegant, for the picnic basket or the dining table.

Written and photographed by Len Cullum

**THIS SALT AND PEPPER WELL** is something my girlfriend spotted in an old magazine. The setting was a rustic country picnic, with nice wine glasses and plates and of course beautiful food. In the midst of it all was this old and well-worn well. It struck me as so much more elegant than the usual cardboard shakers you find in a picnic basket — so I decided to make her one.

It's a simple woodworking project with a twist — you'll use a drill press as a lathe, to shape the little handle that goes on top.

**1. Make the center hole.** As with most of my projects, the first step is to find center. On the 2" face of the block, measure and mark 1" in from each side and 3" in from each end. You are making the point that the cover will pivot on, so take the time to make sure you've found dead center (**Figure 1**).

Using the drill press and a 1/4" bit, drill a hole on this center point about 1" deep.

**2. Cut the coves.** You can do this in different ways, but I like the smooth round and the minimal cleanup that a Forstner bit can give. Since I'm using a 1 3/4" Forstner bit for the salt and pepper wells, I'll use the same to cut the coves. Because drilling a half-round would remove too much of the block, I drill these holes off-center, using a sacrificial piece of 2x4 to act as the fence and to stabilize the drill bit while it cuts.

If you don't have some kind of wooden top

## Materials

- » **Hardwood block, 1 1/2" x 2" x 6"** I used cherry.
- » **Hardwood dowel, 1/2" dia., 4" long**
- » **Hardwood dowel, 1/4" dia., 3" long**
- » **Wood glue**
- » **Paste wax**
- » **Scrap wood, 2x4, about 2' long** This is sacrificial; don't worry about appearance.

## Tools

- » **Drill press**
- » **Drill bits: 1/4", 5/16", 1/2"**
- » **Forstner bit, 1 3/4"**
- » **Handsaw**
- » **Tape measure**
- » **Clamps**
- » **Sandpaper and/or files**
- » **Square**
- » **Top guide bearing from a 1/2" router bit with 1/4" shank**

**BIT OF A TRICK** — A router bit bearing turns your drill press into a mini lathe. See how on page 73.

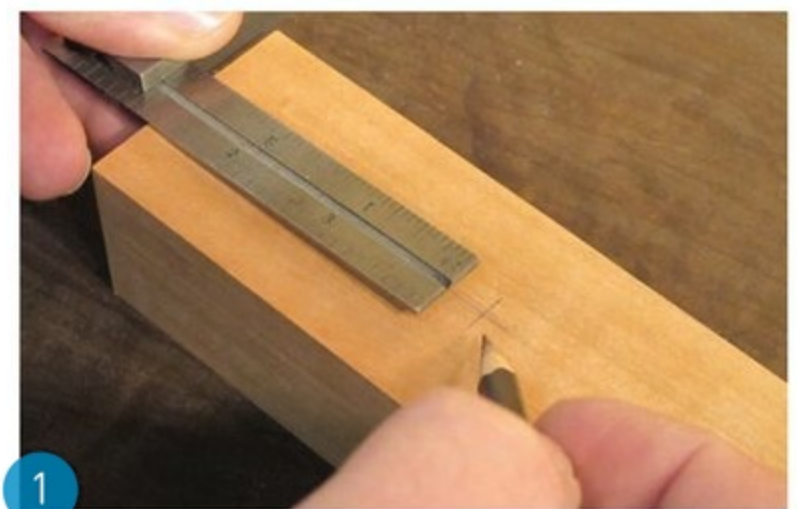

**SHAKE IT UP:** Table salt was served in open "cellars" until the 20th century, when anti-caking agents enabled the triumph of the salt shaker. For sea salts, a cellar still works best.





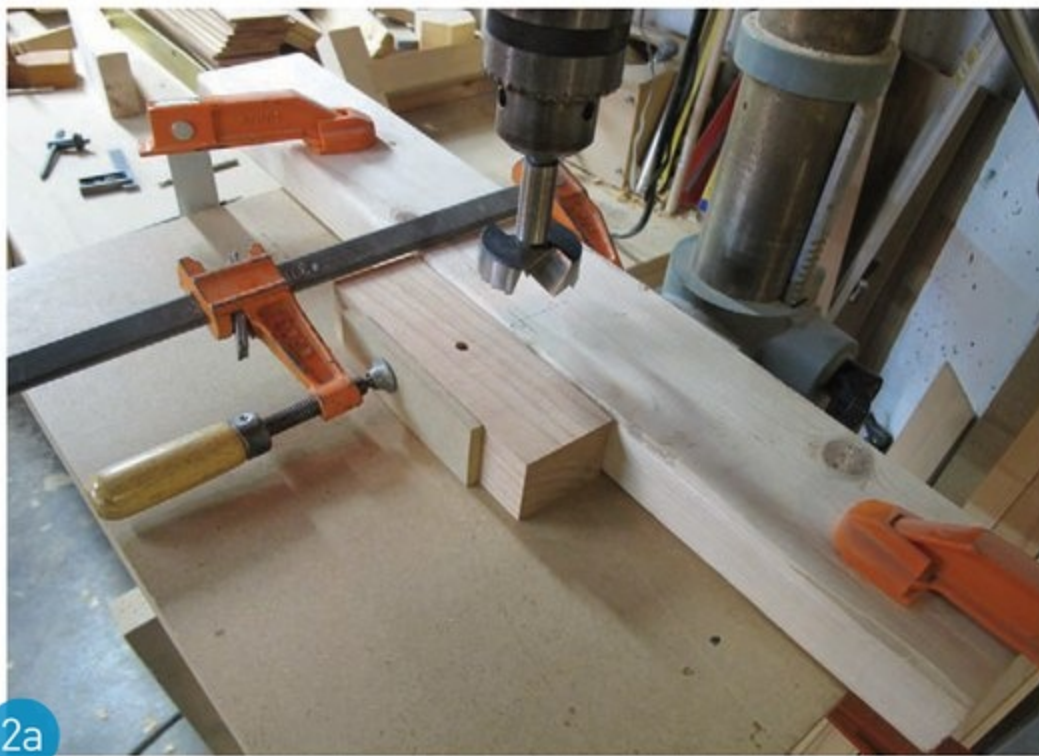

2a



2b



3



4a



4b



5a

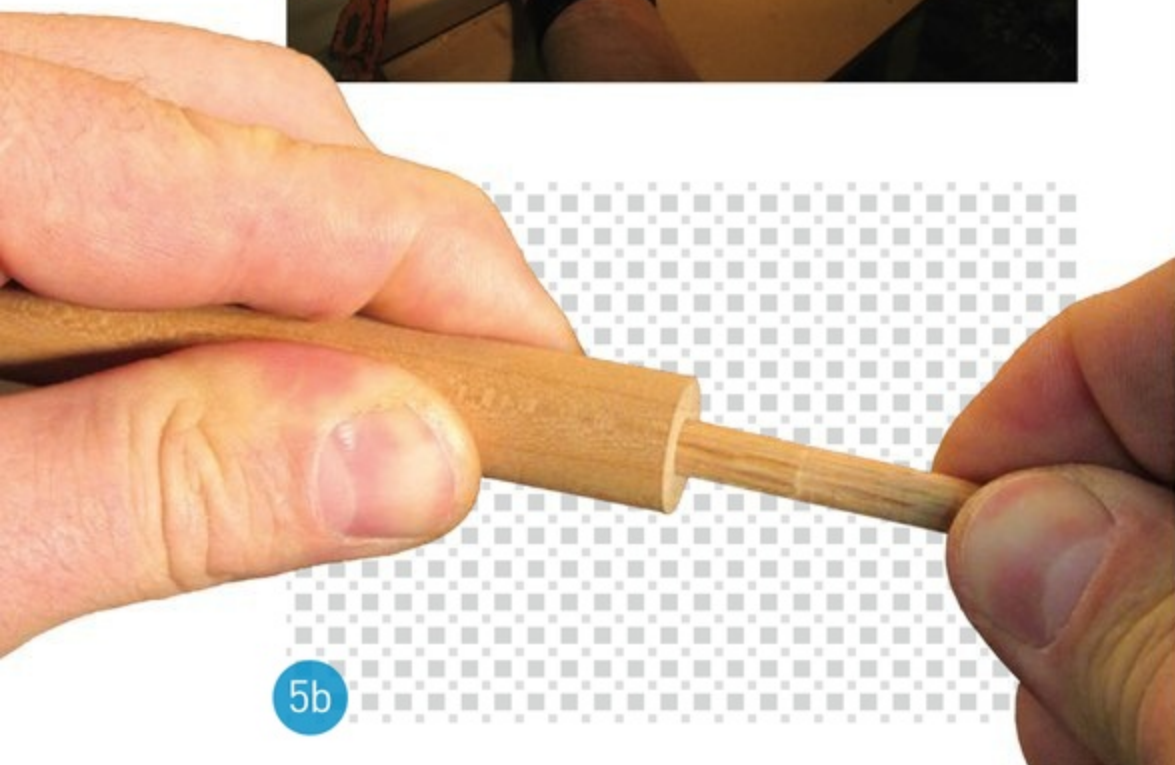

5b

on your drill press table, now would be the time to add one. I use a piece of MDF held on with double-stick tape.

Using a square, make a reference line near the center of the 2x4, then make a mark  $\frac{3}{8}$ " in from the edge. This is the center point for the  $1\frac{3}{4}$ " bit. Center the 2x4 beneath the bit and clamp it in place. Now align the centerline of the block to that on the 2x4 and clamp it in place (**Figure 2a**). Smoothly drill through to the table (**Figure 2b**). Repeat on the other side.

**3. Cut the lid.** Mark a line  $\frac{5}{16}$ " from the top, all the way around the block. Using a handsaw, cut the lid piece away (**Figure 3**).

Lightly mark the top of the lid, to help you orient it during final assembly. Clean up the saw marks with sandpaper or, like I did, with a plane.

**4. Drill the wells.** On the cut face of what is now the bottom piece, make 2 marks centered  $1\frac{1}{8}$ " from either end and drill the two  $1\frac{3}{4}$ " well holes about  $\frac{7}{8}$ " deep (**Figure 4a**). Use sandpaper to soften the edges of the holes (**Figure 4b**).

**5. Make the handle blank.** The handle is made from  $\frac{1}{2}$ " dowel, with its bottom portion narrowed down to  $\frac{1}{4}$ ". Because this portion acts as an axle and holds the whole project together, it's important that it be a fairly accurate  $\frac{1}{4}$ ". However, I've found accuracy to not be one of the features of my lathing method, so I like to insert a  $\frac{1}{4}$ " dowel into the end of the  $\frac{1}{2}$ " one. Here's how to center it:

Clamp the 2x4 to the drill press and drill a  $\frac{1}{2}$ " hole all the way through. Insert the  $\frac{1}{2}$ " dowel. It should be a good fit with little or no wobble. (If it wobbles, give the dowel an even wrap of tape.)

Chuck up the  $\frac{1}{4}$ " bit, and drill  $\frac{1}{2}$ " to  $\frac{3}{4}$ " into the end of the dowel (**Figure 5a**).

Glue the  $\frac{1}{4}$ " dowel into the end and set it aside to dry (**Figure 5b**).

**6. Set up the "lathe."** Mount the "lathe" bearing as described in the "Skill Builder" article on the following page.



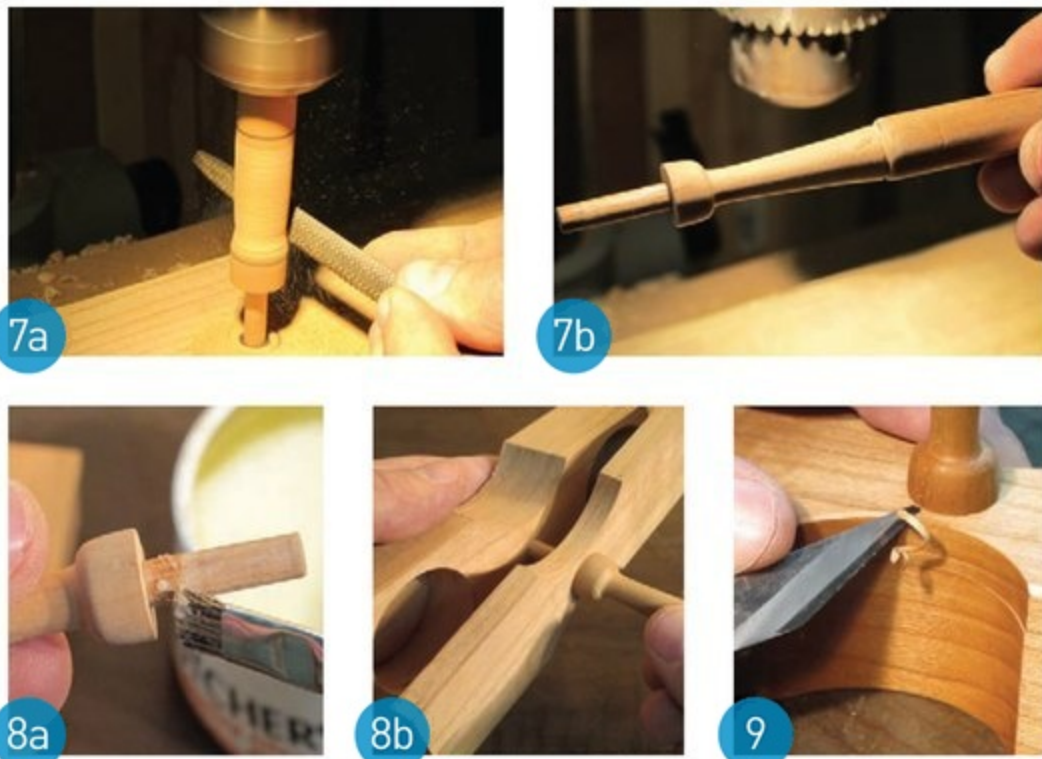

**7. Turn the handle.** Cut off the  $\frac{1}{4}$ " dowel 1" below the shoulder. Mark the  $\frac{1}{2}$ " dowel: You want the handle to be about 2" long, so make a reference mark there to indicate the top, and another at  $\frac{1}{4}$ " to indicate where to start the handle's little base curve.

Chuck the  $\frac{1}{2}$ " dowel in the drill press. Make sure everything is locked down, then turn on the drill press and turn the handle as described in the Skill Builder, cutting the basic shape with rough sandpaper or a file (**Figure 7a**), then smoothing the surface with finer-grit paper. Stop the drill press on occasion to check your progress. When you're happy with it, remove the handle and cut it to length (**Figure 7b**).

**8. Assemble it.** Assembly is straightforward except for one important trick. To prevent the lid from getting glued to the base or the axle, use a small brush to apply paste wax to the upper  $\frac{5}{16}$ " of the  $\frac{1}{4}$ " dowel and to the area surrounding the hole on both the lid and the base (**Figure 8a**). Just be careful not to get wax on the end of the dowel or in the center hole on the base, because it will prevent the glue from bonding. If you don't have paste wax, you can use candle wax or even wax paper.

Using a toothpick or a splinter of wood, apply a small amount of glue to the inside of the hole in the base. Orient the lid the same way it was before you cut it, then press the 3 parts together (**Figure 8b**). Give the lid a couple of turns to make sure it's moving smoothly, and then let it dry. Giving it a turn every 20 minutes or so for the next hour isn't a bad idea.

**9. Finish it.** When the glue has set, let the sanding begin! Soften the corners and smooth all the exterior faces. I like to chamfer the top with a knife (**Figure 9**).

For an exterior finish, I like paste wax or butcher block oil. But avoid getting any on the inside — it might give your salt and pepper an odd flavor or, worse, go rancid and make the well unusable.

You're done. Prepare to picnic! 🍷

See more step-by-step photos and add your comments at [makezine.com/projects/salt-and-pepper-well](http://makezine.com/projects/salt-and-pepper-well)

Share it: [#saltandpepperwell](https://twitter.com/saltandpepperwell)

## +SKILL BUILDER

### USE A DRILL PRESS AS A LATHE

[makezine.com/drillpresslathe](http://makezine.com/drillpresslathe)

Whenever I need a small turned item, I resort to tricking my drill press into thinking it's a lathe. This method is slower — you abrade the material using sandpaper or files instead of shaving it away with chisels — but with patience you can get good results. Here's how I do it, using a common top guide bearing from a router bit.

**1. Choose a router bearing.** The bottom of my workpiece has a  $\frac{1}{4}$ " diameter, so I need a bearing that fits a  $\frac{1}{4}$ " shaft.

**2. Mount the bearing.** Clamp a scrap of 2x4 to your drill press table and drill a hole to fit your bearing, about  $\frac{1}{4}$ " deep. (I prefer a Forstner bit, but a twist bit is fine.) Then drill a clearance hole  $\frac{1}{16}$ " wider than your shaft width (in this case  $\frac{5}{16}$ " ) through the center of the first hole, all the way through the 2x4. Insert the bearing into the hole. It should fit snugly; if it's loose, give it a wrap of tape.

**3. Mount the workpiece in the drill press.** Tighten the chuck, but not enough to crush the wood. Lower the chuck so the end of the workpiece goes through the bearing, then use the depth stop on the press to lock it in place. Turn on the drill press. Your workpiece should spin smoothly.

**4. Turn and shape your workpiece.** For initial shaping, I use either a file or an aggressive-grit sandpaper (60 or 80) wrapped around a dowel. Take your time, stay focused, and avoid getting your fingers or the tip of the tool too close, as this can cause it to kick. Pressing too hard will only clog your file or, worse, throw the dowel off center.

Once you've worked the piece down to shape, fold a strip of finer-grit paper (120–220) and smooth the surface.

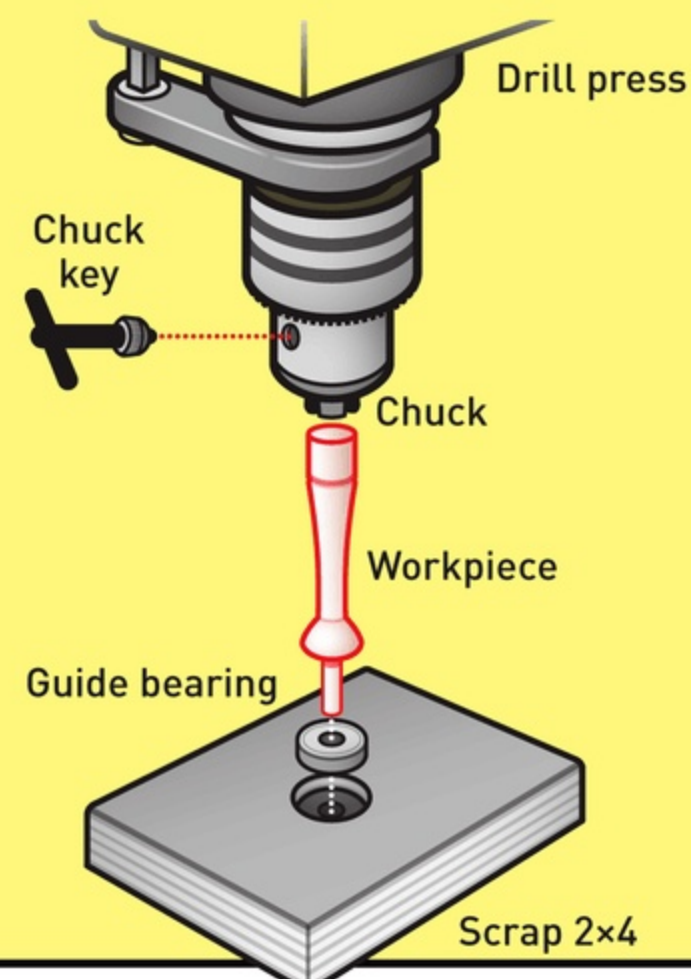

**CAUTION:** THIS PROCEDURE IS POTENTIALLY DANGEROUS AND CAN QUICKLY VOID THE WARRANTY ON YOUR FINGERS. IF AT ANY POINT THE LITTLE VOICE INSIDE YOUR HEAD STARTS SAYING "YOU SHOULDN'T BE DOING THIS" OR "UH-OH," LISTEN TO IT AND STOP. YOU HAVE BEEN WARNED.



# LibraryBox: Portable Private Digital Distribution

Want to share files and bypass the internet? Build a mobile, anonymous wi-fi file server with off-the-shelf hardware.

Written by Jason Griffey ■ Photographed by Jason Griffey and Bo Baker

**Time Required:**  
**20-40 Minutes**

**Cost:**  
**\$40-\$60**

Fileshare anonymously for \$40? It's almost too easy!

**JASON GRIFFEY**

is an associate professor and head of Library Information Technology at the University of Tennessee at Chattanooga. He has written extensively for the ALA on topics such as personal electronics in the library, privacy, copyright, and intellectual property. He spends his free time with his daughter Eliza, reading, obsessing over gadgets, and preparing for the inevitable zombie apocalypse.  
[jasongriffey.net](http://jasongriffey.net)



## MATERIALS

- » 3G router, TP-Link model MR3020
- » USB to Mini-B cable included in MR3020 package
- » Ethernet cable included in MR3020 package
- » USB thumb drive, FAT32 formatted any capacity that will hold the material you wish to distribute
- » Computer with internet connection
- » Router with open Ethernet port
- » Terminal program for telnetting and SSHing into the MR3020. We suggest using Putty on a Windows PC, and just Terminal on OSX or Linux.
- » Battery pack with USB output (optional) to run your Library-Box on the go

### WHAT CAN YOU DO WITH A LIBRARYBOX?

The real strength of LibraryBox is its portability and low-power nature. Anywhere there is limited or no internet connectivity but still a need to deliver digital files, LibraryBox can do it.

- Transmit spy documents without ever going on the internet.
- Stream music and images to everyone's phone at a party.
- Share photos and videos at reunions and weddings.
- Stream music at your campsite or on your beach blanket.
- Set up anonymous chat networks.
- Distribute information in countries where internet use is censored, forbidden, or insecure.
- Share healthcare information in the jungles of Peru.
- Share digital textbooks to schools in remote villages.
- Share e-books from a roving bookmobile.



**LIBRARYBOX WAS INSPIRED BY THE PIRATEBOX ART PROJECT BY DR. DAVID DARTS, CHAIR OF THE DEPARTMENT OF ART AT NEW YORK UNIVERSITY.** PirateBox is a mobile, anonymous file-sharing device, allowing anyone to upload and download digital files from mobile phones, laptops, and plug computers. When PirateBox developers managed to leverage the project onto inexpensive 3G-to-wi-fi routers, I had the idea to fork PirateBox into LibraryBox.

Libraries are a bastion of sharing and a cornerstone of freedom of information. Still, I knew I would have a hard time convincing libraries to use something called PirateBox. I poked around in the code to see what could make it more appealing to libraries and educators. The most obvious change was to remove the ability to upload files anonymously.

So how do you use LibraryBox? Put your digital content on a USB stick, plug in the stick, and power up the device, which will act as a wireless digital download hub. Share anything! It'll even stream video and audio — it's robust enough to stream HD MP4 video to an iPhone or iPad — and it runs all day on a rechargeable battery pack.

**Make It.** To make a LibraryBox, you just flash the router with new OpenWrt firmware, then telnet to the router and install PirateBox software from the command line (it's easy). Finally, install the LibraryBox software from your USB stick. That's it!

**Use It.** To use a LibraryBox in the wild, people simply connect their devices to the "LibraryBox — Free Content!" SSID and open any webpage in their browser. The device acts as a captive-portal, redirecting the request to its internal pages. The default install also includes a Chatbox where users can communicate anonymously.

LibraryBox has been tested on a range of mobile phones, laptops, and tablets. Just about any device with wi-fi and a web browser can connect and download files from LibraryBox.

I've even designed two 3D-printable enclosures for it: a small one for very low-profile USB drives like the Sandisk Cruzer Fit, and a larger one with more room. Find both at [thingiverse.com/griffey](http://thingiverse.com/griffey).

Much of the world has intermittent internet access at best. But the mobile phone is becoming ubiquitous, and LibraryBox can bring education information, health information, and entertainment to the parts of the world where smartphones outstrip web access.

## Version 2.0

The LibraryBox Project recently completed a successful Kickstarter campaign to fund the v2.0 release, currently in development with Matthias Strubel (lead developer for PirateBox). It will include many upgrades, from SFTP content updating and mesh network content sharing to a revised UI based on Bootstrap, plus a hugely simplified installation. To keep up with LibraryBox, visit [librarybox.us](http://librarybox.us). ☑

Many thanks to Dr. David Darts, Matthias Strubel, Matt Neer, Ross Singer, and Andromeda Yelton.

Get complete instructions, photos, and project code at [makezine.com/librarybox](http://makezine.com/librarybox)

Share it: [#librarybox](https://twitter.com/librarybox)

# Zombie Flashlight

Build a powerful pocket flashlight with reclaimed parts and an "undead" battery!

Written by Chester Winowiecki



**Time Required:**  
**An Afternoon**  
**Cost:**  
**\$0-\$20**

**CHESTER WINOWIECKI** makes stoneware pottery and builds musical instruments in Whitehall, Mich. His article "The Panjolele" ([makezine.com/panjolele](http://makezine.com/panjolele)) appeared in MAKE Volume 33.

**THE "JOULE THIEF" CIRCUIT CAN POWER A 3V WHITE LED WITH A SINGLE 1.5V BATTERY.** Not only can it boost the voltage, it can do it with a battery that's considered dead, stealing the last bits of energy from the cell.

I built my first joule thief on a breadboard from scrap parts. I even had a bin of dead batteries that I hadn't recycled yet. I felt like Victor Frankenstein or George Romero!

I really wanted this flashlight to be a nice everyday carry, like my old AAA Maglite. I found a few tutorials for stuffing all the parts into a miniature incandescent bulb housing but that didn't do it for me. Then I found a used-up tube of lip balm in an old pair of pants. Could I fit it all in there and an on/off switch besides? Yes!

Here's how to do it:

1. Gut and clean the tube.
2. Wind a tiny transformer.
3. Wire the "joule thief" circuit.
4. Build the switch.
5. Put it all together.

Make lots of Zombie Flashlights for your friends and include a "dead" battery. It's great fun giving these scrap parts and batteries another life, and they might just come in handy during the next zombie outbreak. ☑

For build instructions, photos, and schematics, go to [makezine.com/zombie-flashlight](http://makezine.com/zombie-flashlight)

Share it: [#zombieflashlight](https://twitter.com/zombieflashlight)







# License Plate Guitar

Make this DIY “resonator” guitar with a hand-wound electromagnetic pickup.

Written by Matt Stultz and James Rutter

## MATT STULTZ

is the leader of the 3D Printing Providence group, founder of HackPittsburgh, and a MakerBot alum, with experience in multimaterial printing and advanced materials.

## JAMES RUTTER

is the labs manager at AS220 Labs in Providence, RI. When he's not fixing machines, he enjoys playing music with his band.

**IN MAKE VOLUME 04, ED VOGEL SHOWED US HOW TO MAKE A DIY GUITAR OUT OF A CIGAR BOX AND JUNK FROM THE HARDWARE STORE, AND ELECTRIFY IT WITH A CHEAP PIEZOELECTRIC PICKUP.** In Volume 21, Mark Frauenfelder gussied it up with a traditional high-quality neck, frets, and tuning machines.

In this project we're going to turn it up to 11, with the help of an old license plate and a few components from RadioShack.

The License Plate Guitar is easy to make. You'll wind your own electromagnetic pickup and mount it on a homemade soundbox made with an old automobile license plate for the metal top — kind of a low-budget version of a resonator guitar. Then add a potentiometer and volume knob and get ready to rock that classic electric blues sound.

Here's an overview of how to do it — for full step-by-step photos and video, visit the project page at [makezine.com/license-plate-guitar](http://makezine.com/license-plate-guitar).



**Time Required:****A Weekend****Cost:****\$100-\$140**

There's nothing like playing an electric guitar you made.

**Materials**

- » License plate, automobile
- » Hardwood lumber, 1"×3", about 40" length
- » Guitar neck with headstock, for cigar box guitars We chose a fully fretted neck, CB Gitty #37-002-02F ([cbgitty.com](http://cbgitty.com)), but you can also go for a nonfretted model, or build your own.
- » Bone nut such as CB Gitty #31-053-01
- » Tuning machines (4) such as CB Gitty #31-077-01
- » Wood glue
- » Wood screws, #10, 1½" long (2)
- » Wood screws, pan head, #8 or #10, ¾" long (4)
- » Hardwood scraps (optional) for mounting license plate; see Step 4
- » Plywood, ¼", about 6"×6" and 12"×6"
- » Machine screws, #8-32, 1¼" length (4) with nuts
- » Magnet wire, 22 gauge, about 40' length RadioShack #278-1345
- » Rare-earth magnets, round, ¾/16" dia. (4) RadioShack #64-1895
- » Cyanoacrylate glue aka super glue
- » Potentiometer, 100kΩ, linear taper RadioShack #271-092
- » Audio jack, ¼", mono RadioShack #274-255
- » Audio cable, shielded RadioShack #278-513
- » Volume knob RadioShack #274-407
- » Guitar strings, electric (4) not acoustic. Buy 1 pack at a local music store or online.
- » Wood screws, countersunk head, ¾" (4)

**Tools**

- » Nibbler such as RadioShack #55010716. If you're working with sheet metal, the nibbler will become your best friend.
- » Coping saw
- » Miter box and saw
- » Drill and drill bits for both wood and metal
- » Corner clamps
- » Screwdriver
- » Metal files (optional) to clean up rough edges
- » Sandpaper
- » Soldering iron and solder

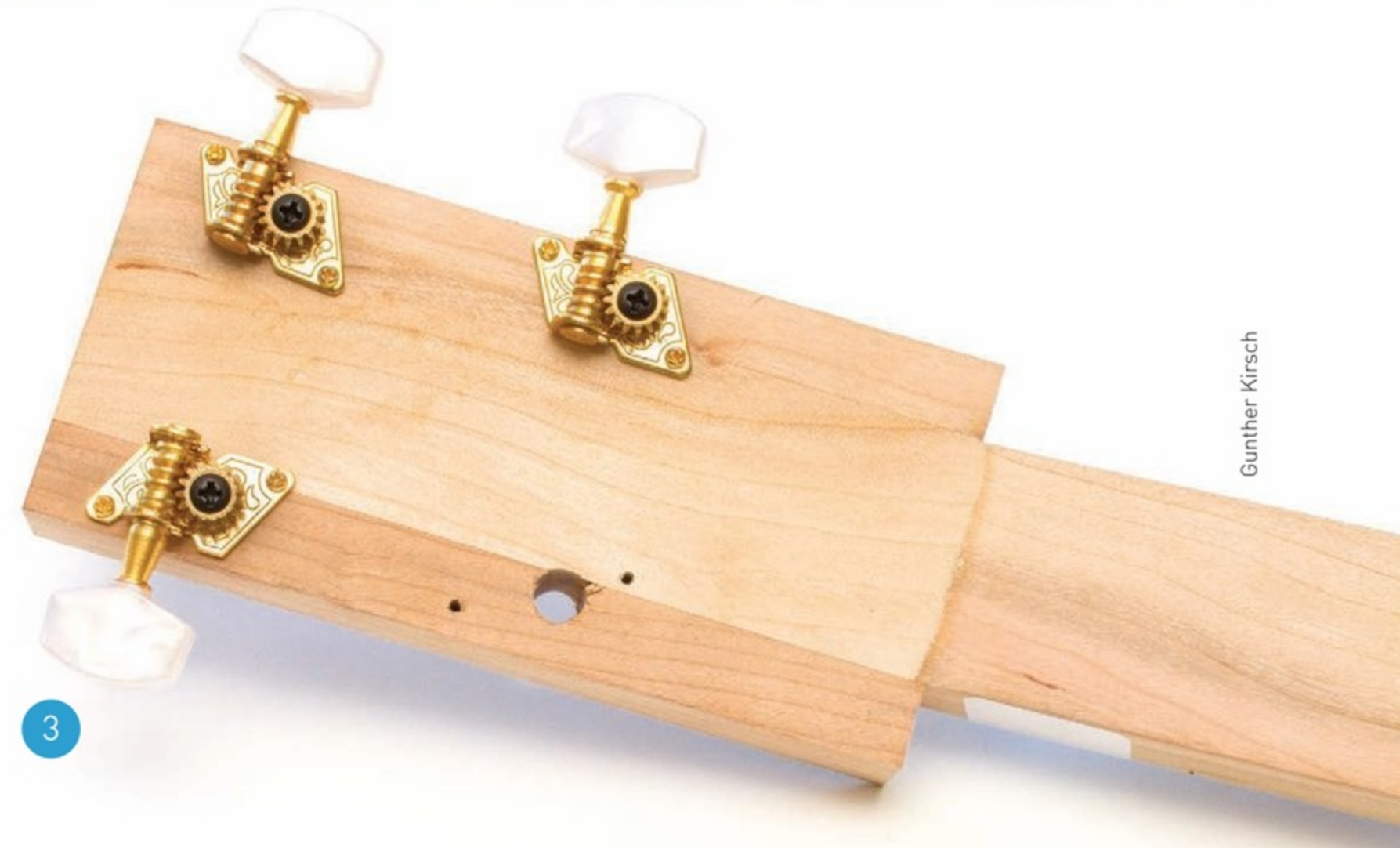

Gunther Kirsch

**1. Build the guitar body box**

Miter-cut the 1×3 boards to build a "picture-frame" box the same size as your license plate. Glue and clamp it overnight.

**2. Cut out the license plate**

Mark the location for your pickup, then use a sheet metal nibbler tool to cut out the hole. The pickup you'll build is almost exactly the same size as a single letter or number on the plate.

**3. Prepare and attach the neck and stringholder**

You can make your own neck from scratch (see [makezine.com/cigarboxguitar](http://makezine.com/cigarboxguitar) for instructions), but a store-bought neck made for cigar box guitars is easiest for this project. Cut the neck down for a 25" scale length, then cut a groove across the top of the fretboard and glue the nut in place. Drill four ¼" holes in the headstock to mount the 4 tuning machines.

To make the stringholder, drill four ⅛" holes in a short scrap from the neck. Mount the neck and stringholder squarely to the body box using glue and long wood screws.

**4. Attach the license plate**

Use pan-head wood screws to attach the plate to the top of the body box. Depending on your plate, you might need to add small wood blocks inside the box to accept these screws.





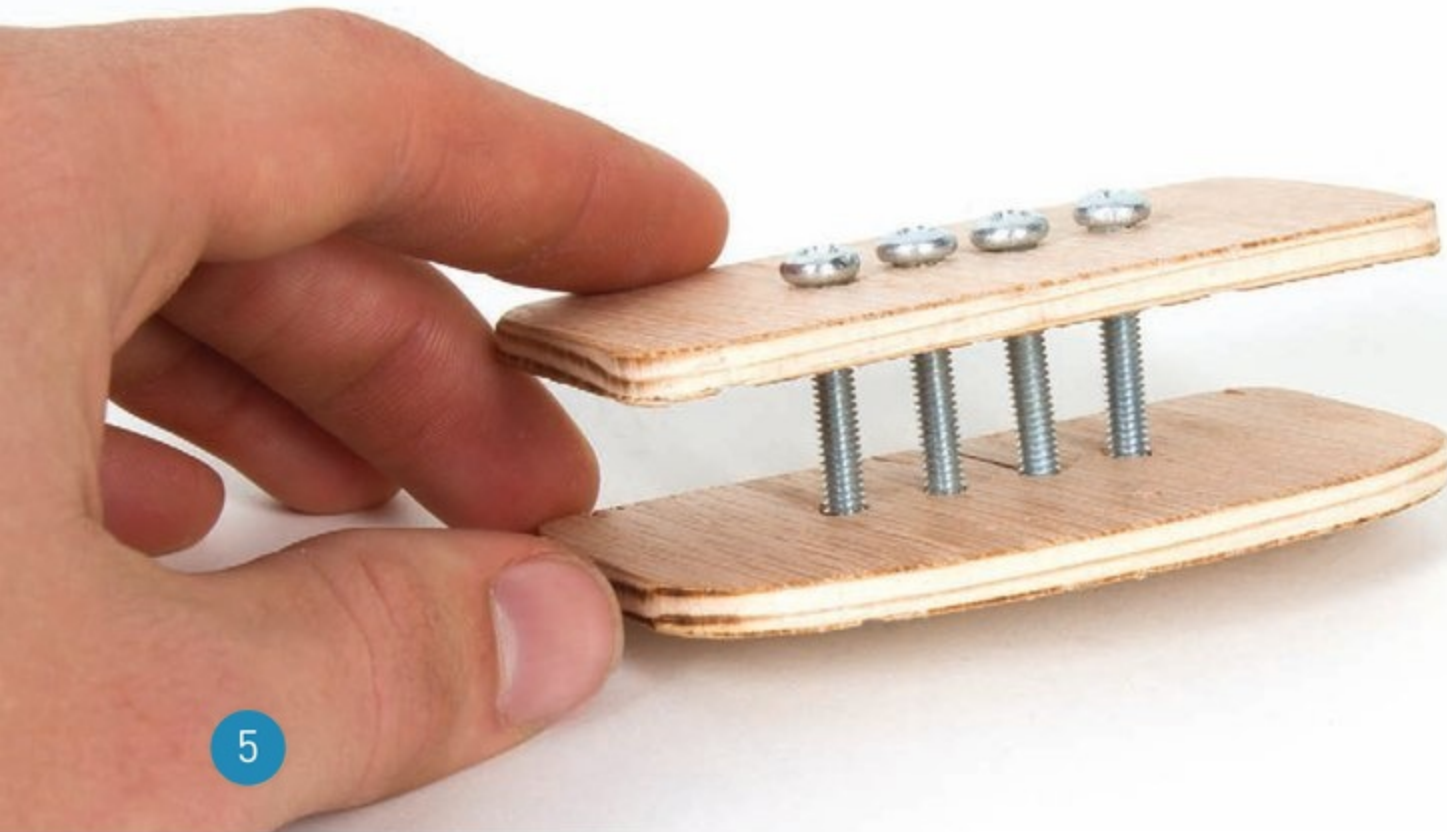

5

### 5. Build the pickup bobbin

Cut the bobbin's top and bottom plates out of thin plywood, then drill the plates and assemble them using 6-32 machine screws and nuts.

### 6. Wind the pickup

Wrap the entire spool of magnet wire neatly around the group of 4 screws at the center of your bobbin. Wrap evenly and consistently, starting at the bottom and building layers to the top. Secure both ends of the wire in the bottom plate's 2 wire-mounting holes.

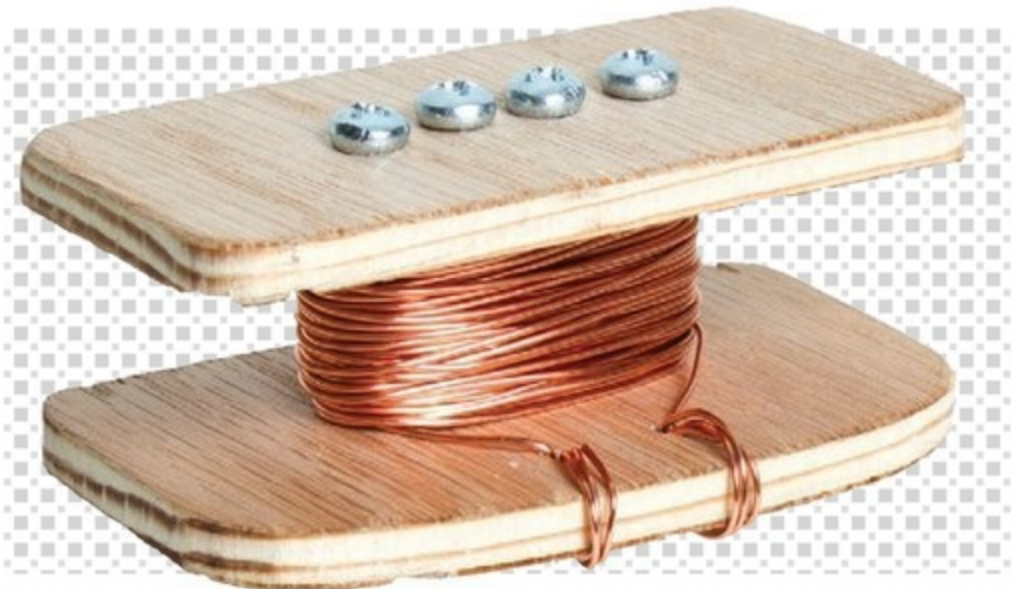

6

### 7. Add magnets

Place one rare-earth magnet on top of each screw, at the end with the nut, with a drop of super glue.

### 8. Wire the pickup, audio jack, and volume pot

Sand the clear coating off the ends of the magnet wire, then solder a 2-conductor audio cable to the pickup (either way is fine). Wire the audio jack with another length of audio cable: red to tip, white to ring. Connect the pickup's red wire to one of the volume pot's outer pins, the jack's red wire to the center pin, and both white ground wires to the other outer pin.



7

### 9. Mount the components

Drill holes in the license plate for the pot and jack, then mount them both and the pickup too.

### 10. Add the bridge

Measure exactly 25" down from the nut, mark the license plate there, and glue the bridge in place at your mark.

### 11. String your guitar and rock out!

Thread the 4 strings through the holder, starting with the thickest and ending with the thinnest. The thickest string should mount into the lower left tuning machine, followed by the top left, the top right, and the bottom right.

When all the strings are in place, tighten down the tuning machines evenly but without applying too much tension.

Plug your License Plate Guitar into your amp, switch on the amp, and strum the strings. You should hear your new electric guitar!

Close it up by attaching the thin plywood back to the guitar body with the short countersunk wood screws.



8





### Tuning and Playing

There are numerous free apps for iOS, Android, Windows, and Mac that will allow you to tune the guitar. Choose the scale you'd like, and then tune each string to the proper pitch. Now plug your new guitar into your amp and rock on!

A popular tuning for small guitars like this is called *open G* tuning. As Mark wrote in Volume 21, "Many of the original blues guitar players used open G, and it's a favorite with Keith Richards of the Rolling Stones."

For more tips and lessons on playing your License Plate Guitar, look for Keni Lee Burgess and Shane Speal at Cigar Box Nation ([cigarboxnation.com](http://cigarboxnation.com)) or on YouTube. 🎸

Get down! Step-by-step photos and rockin' video: [makezine.com/license-plate-guitar](http://makezine.com/license-plate-guitar)

Share it: [#licenseplateguitar](https://twitter.com/licenseplateguitar)

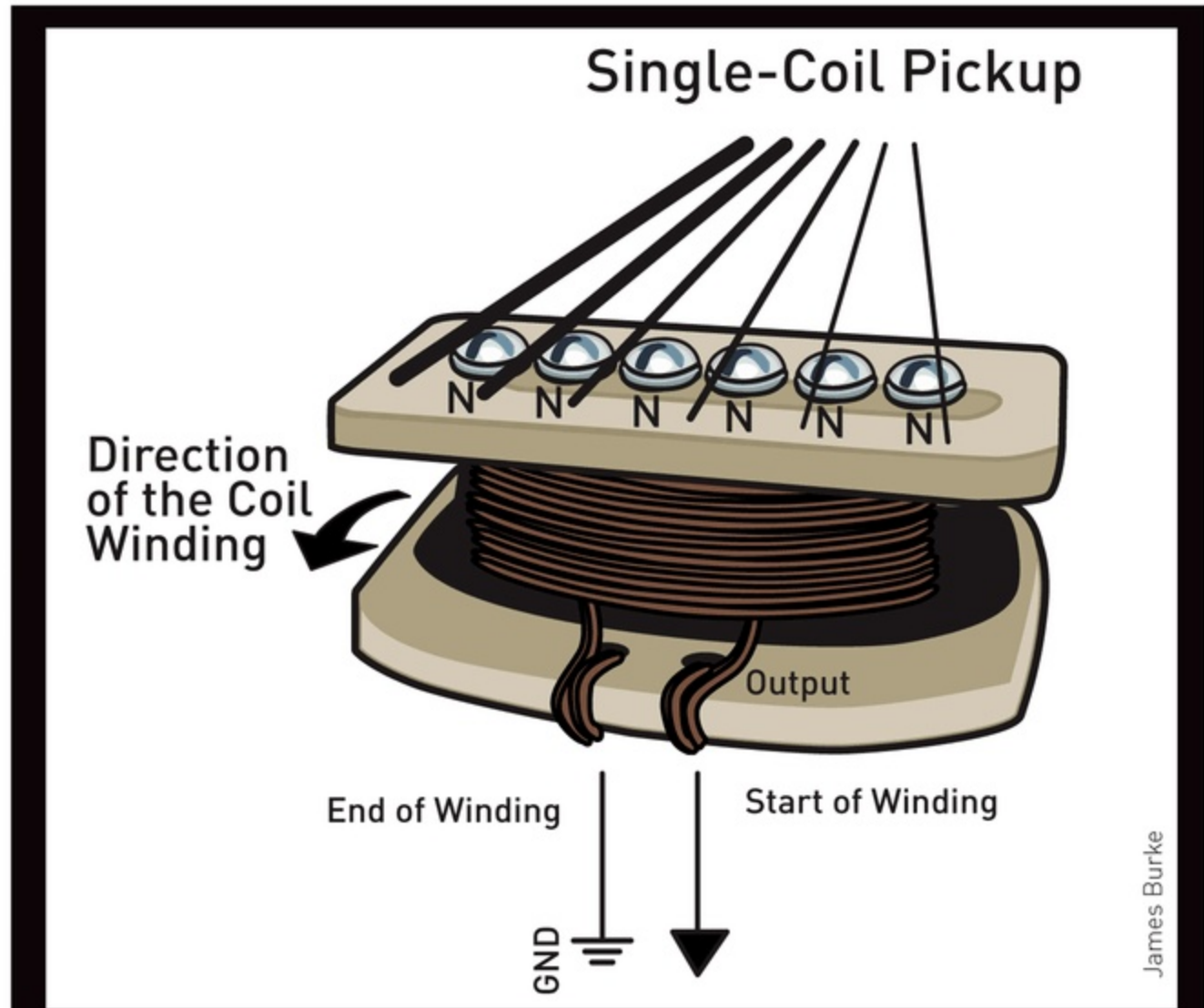

James Burke

## PICK ME UP

An electric guitar uses an electromagnetic transducer known as a *pickup* to capture the mechanical vibration of the strings and convert it into an electrical signal that's sent to the amplifier. It's basically a coil of wire and some magnets; vibration of the metal guitar strings creates fluctuations in the magnetic field, which are picked up and converted to a small alternating current.



Andrew Goodman



# Sir George Cayley and the Glider

**Time Required:**  
2-3 Hours  
**Cost:**  
\$25-\$30

Unlike its flapping predecessors, this fixed-wing flying machine actually flew!

## WILLIAM GURSTELLE

is a contributing editor of MAKE. The new and expanded edition of his book *Backyard Ballistics* is available in the Maker Shed ([makershed.com](http://makershed.com)).



## Materials

- » Wire, 18 gauge solid, 24" length
- » Spruce or balsa wood:
  - 3/8" x 3/8" x 36" (1) for the fuselage
  - 3/8" x 1/8" x 36" (3) for 36" wing spars (2), 3/4" wing ribs (6), 6" center wing rib (1), and 2" tail blocks (2)
- » Balsa wood, 3/8" x 1/16": 12" (2) and 10 1/2" (2) for tail pieces
- » Cable ties, 5" or longer (7) aka zip ties
- » Bolt, #10 x 2 1/2", with 3 nuts
- » Silk fabric, tissue paper, or Mylar, 4-6 sq. ft.
- » Thread or ribbon

## Tools

- » Knife or small saw
- » Hot glue and glue gun
- » Soldering iron and solder
- » Drill

Build the simple plane that defined modern aircraft – 100 years before the Wright brothers. *Written by William Gurstelle*

**THE TITLE "THE FATHER OF AERONAUTICS" COULD BE BESTOWED ON A LOT OF DIFFERENT PEOPLE, BUT I'D GIVE IT TO ENGLISH-MAN GEORGE CAYLEY (1773-1857), SIXTH BARONET OF BROMPTON.** Sir George was a gifted inventor who made his mark on ballistics, civil and biomedical engineering, and mathematics. But without doubt his greatest achievements were in aeronautical engineering.

Cayley did most of his work on flying machines around the turn of the 19th century, 100 years before the Wright brothers. At the time, there was no engine light enough or powerful enough to get a vehicle airborne, so Cayley's most significant inventions were unpowered gliders. Nonetheless, his work was monumental: In 1799, he developed the modern concept of the airplane.

Cayley's idea, like many others that changed the world, was extremely simple: He was the first to completely separate a flying machine's propulsion systems from its lifting systems.

Before Cayley, everyone from Daedalus to da Vinci believed that flapping was the pathway to the air. Flight had been attempted, unsuccessfully, in ornithopters, aircraft that flapped their wings like birds in flight. (See *Rubber Band Ornithopter*, MAKE 08) In Cayley's concept, lift was provided by a fixed sail whose surface was held taut by air pressure.

In 1804, Cayley designed, built, and successfully flew the first recognizable airplane-like thing: a small bamboo and paper monoplane glider. More or less modern in appearance, it featured a fuselage, a kite-shaped wing, an adjustable

## BUILD A 5-FOOT Balsa GLIDER

[makezine.com/medicine-man-glider](http://makezine.com/medicine-man-glider)

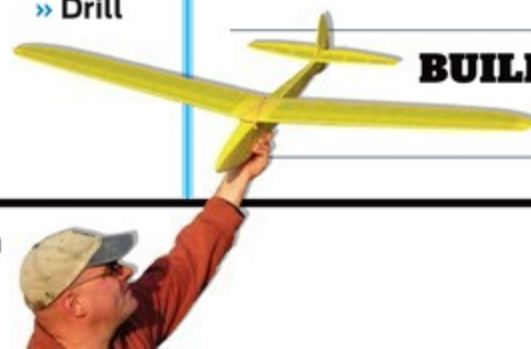





Sir George Cayley built the first fixed-wing glider (1804) and first manned glider (1853).

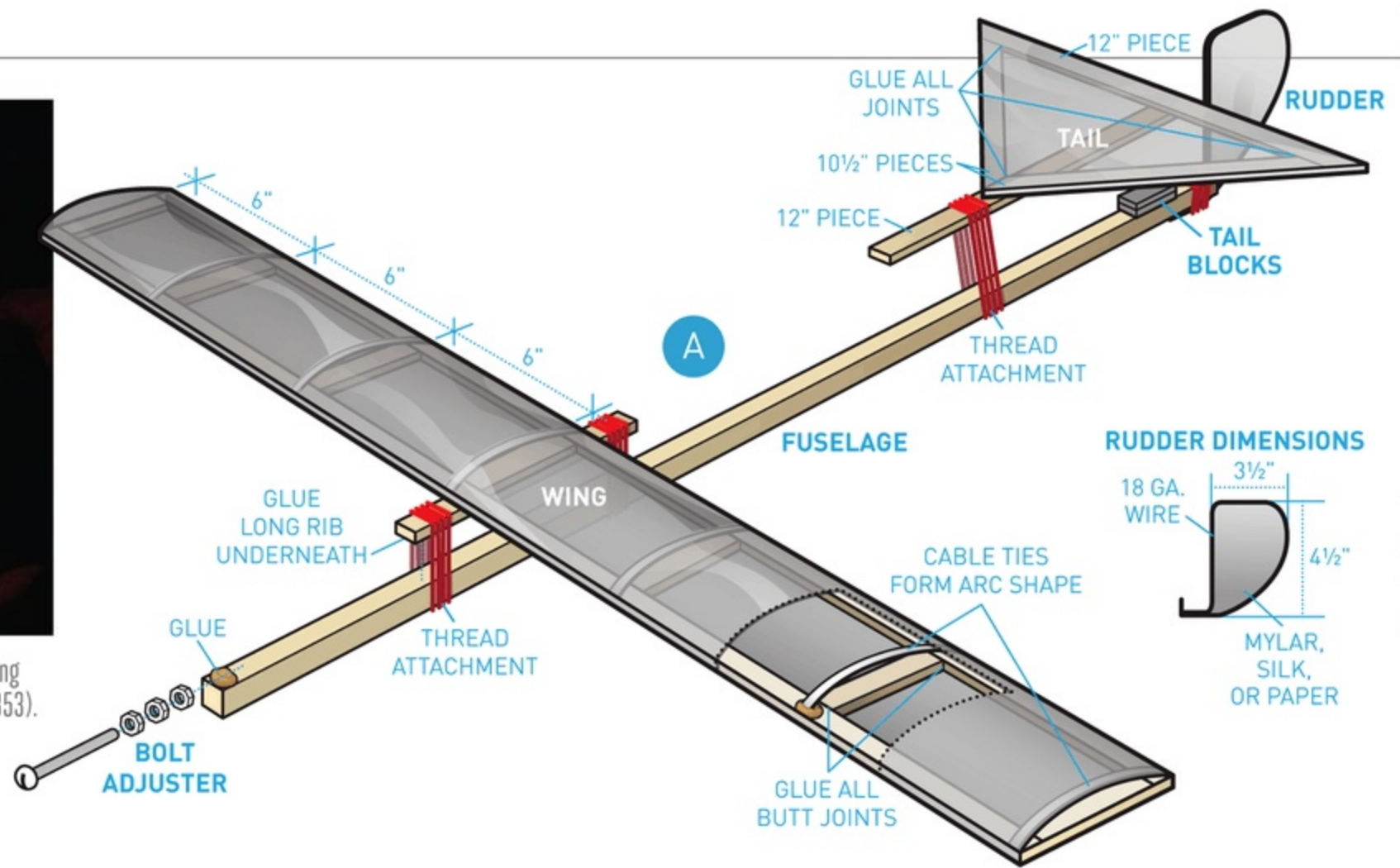

tail and back fins to control the direction of flight, and a moveable weight to adjust the glider's trim or center of gravity. It was the first man-made object that incorporated the control and aerodynamic concepts of today's airplanes, and probably the first aircraft in history able to make significant glides. This thing actually flew!

Cayley also recognized that many forces operate simultaneously upon a body in flight. The ideas of thrust, lift, weight, and drag, now the cornerstones of aeronautical engineering, were first articulated by Cayley.

About 50 years later, Cayley returned to glider design and built a really big one. Towed aloft behind a galloping horse, it was big enough to carry his coachman on a 200-yard flight, making it the world's first successful manned glider.

## Build a Cayley Glider

Let's build a glider very similar to Cayley's 1804 design. (I've swapped his low-aspect-ratio sail for a high-aspect-ratio wing because, truth be told, the original doesn't fly all that well.)

**Figure A** shows the layout of the airframe. The wing and tail are attached with thread or ribbons, and may be moved about on the fuselage stick to obtain the best flight characteristics. The key to making this glider is to shape the upper wing surface to make an *airfoil* — a curved surface that creates a pressure differential above and below, thus providing lift. You'll make the curve using common zip ties.

**1. Rudder.** Bend the wire into a rudder shape as shown, with a projecting pin across the bottom. Clip off excess wire, then solder the ends of the wire together.

Cover the wire form with silk, tissue paper, or Mylar. Making shallow cuts in the covering at intervals will allow you to turn the fabric under and glue it neatly.

Drill a hole in the main fuselage stick just large enough for the rudder's projecting pin, about 1" from the end.

**2. Tailpiece.** Cut and glue the tailpiece out of  $\frac{3}{8}$ " x  $\frac{1}{16}$ " balsa, overlapping the joints. Cover the tail with fabric using glue.

**3. Wing.** Cut and glue the wing frame out of  $\frac{3}{8}$ " x  $\frac{1}{8}$ " balsa or spruce. Butt-joint the 6 wing ribs inside the two 36" spars, then glue the center rib on top. Let the glue dry.

Flip the wing over and hot-glue the 7 cable ties to the spars, opposite each rib. To form the curve of the wing, glue one end of the tie, bend it into a gentle arc  $\frac{3}{8}$ " above the rib at midpoint (use a scrap of  $\frac{3}{8}$ " balsa as a gauge), then glue the other end and trim it neatly (**Figure B**).

**4. Wing fabric.** Carefully cover the wing with silk, tissue paper, or Mylar using glue. The wing surface should be smooth and taut on both sides.

**5. Tail blocks.** Glue the tail blocks, one atop the other, to make a  $\frac{1}{4}$ " high block. Glue it atop the fuselage, 2" from the end.

**6. Weight bolt.** Place 3 nuts on the #10x2 $\frac{1}{2}$ " bolt and hot-glue the tip of the bolt to the nose of the fuselage.

**7. Assembly.** Use thread or ribbon to lash the long center ribs of the wings and tail to the fuselage. Center the wing 8" back from the nose, and align the back edge of the tail with the middle of the tail block.

Insert the rudder's pin and lash it on too.

## Fly It

Hold the glider lightly and give it a level toss. If it nosedives, untie the wing and move it back a little. If it rises too steeply and then stalls, move the wing forward.

You can make fine attitude adjustments by moving the horizontal tailpiece forward or back, and by spinning the nuts on the nose bolt. You can control yaw (left or right direction) by adjusting the rudder.

A well-made glider can travel a surprisingly long distance — experiment! 🚀

For step-by-step photos and more, fly to [makezine.com/cayley-glider](http://makezine.com/cayley-glider)

Share it: [#cayleyglider](https://twitter.com/cayleyglider)





# Three-Day Kimchi

Piquant, fiery, and fast to make, this lacto-fermented version might just get you hooked.

Written by Wendy Jehanara Tremayne ■ Photographed by Gunther Kirsch



**Time Required:**  
**30 Minutes Prep,**  
**3 Days Ferment**  
**Cost:**  
**\$5-\$10**

## WENDY JEHANARA TREMAYNE

([gaiatreehouse.com](http://gaiatreehouse.com)) teaches yoga and Sufi philosophy, and pursues a post-consumer life in Truth or Consequences, N.M. ([blog.holyscraphot springs.com](http://blog.holyscraphot springs.com)). She also founded Swap-O-Rama-Rama, now a mainstay of Maker Faire.

## Materials

- » 1 head of your favorite cabbage
- » 1lb carrots
- » 8 cloves chopped garlic or chopped onion
- » 2 Tbsp minced ginger
- » 2 Tbsp sesame oil or fish oil
- » 2 tsp salt
- » ½ tsp dry red pepper flakes
- » juice of 2 limes
- » 1 pint whey from kefir, yogurt, or live cheese. Making cheese and other dairy products produces a byproduct called whey, a protein-rich liquid full of probiotics.
- » Mason jars with lids
- » Airlocks (optional)

**KIMCHI IS THE FUNKY, SPICY, ANCIENT KOREAN FERMENATED CABBAGE DISH** that's being rediscovered by chefs today. While traditional kimchi takes months to make, our lacto-fermented kimchi is ready in days because it cooks the vegetables enzymatically. (Microorganisms work with enzymes, a chemical catalyst, to "predigest" your food.) It's full of healthy probiotics and vitamin C. And did I mention it's delicious *and* inexpensive?

- 1. Shred cabbage and carrots** and fill mason jars with the mix. Press them down with the back of a spoon to pack the jar tight.
- 2. Mince the garlic and ginger** in a bowl with sesame oil, salt, red pepper flakes, lime juice, and kefir whey that has been inoculated with a spoonful of kefir culture. (Any whey that contains a live culture will do: Try yogurt, live cheese, or kefir.)
- 3. Pour the liquid mixture** over the vegetables so that they're completely covered. Leave a little space at the top for expansion. Cap tightly and store at room temperature, away from sunlight.
- 4. After about 24 hours**, the lid will pop up from pressure. Refrigerate to slow fermentation.

**Finishing:** After 3 days in the fridge, the culture has fermented the vegetables and spices in the jar, and your kimchi is ready to eat. Serve over rice. 🍴

Get more appetizing information and recommended reading at [makezine.com/three-day-kimchi](http://makezine.com/three-day-kimchi)  
 Share it: [#threedaykimchi](https://twitter.com/threedaykimchi)

✦ Excerpted from *The Good Life Lab*® Wendy Jehanara Tremayne. Used with permission of Storey Publishing.



## More Fermented Favorites

Make these three and more at [makezine.com/projects](http://makezine.com/projects)

### Kombucha

Brew the staggeringly popular fermented tea.

### Yogurt

Turn a crockpot into a yogurt bot using an Arduino.

### Cider

Juice, strain, and bottle your own hard apple cider.



# 1 2 3

## Jumbo Hand-Launcher for Folding Wing Glider

Written by Rick Schertle ■ Illustrations by Julie West

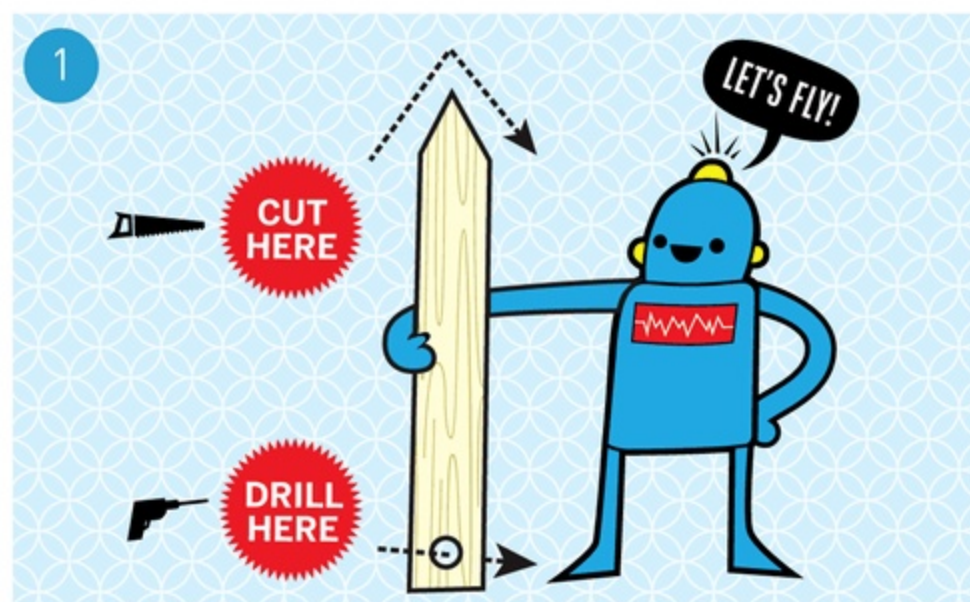

**SINCE THE ROCKET GLIDER PROJECT WAS RELEASED IN MAKE VOLUME 31** ([makezine.com/go/rocketglider](http://makezine.com/go/rocketglider)), it's been wildly popular. But one struggle that younger builders have is getting the glider pulled back on the handheld catapult. With this portable and inexpensive launcher, even the youngest kids can achieve impressive flights.

### 1. Cut a stake and drill a hole

Make 2 angled cuts in the pine board to form a point on one end, then drill a 1/4" hole centered on the opposite end.

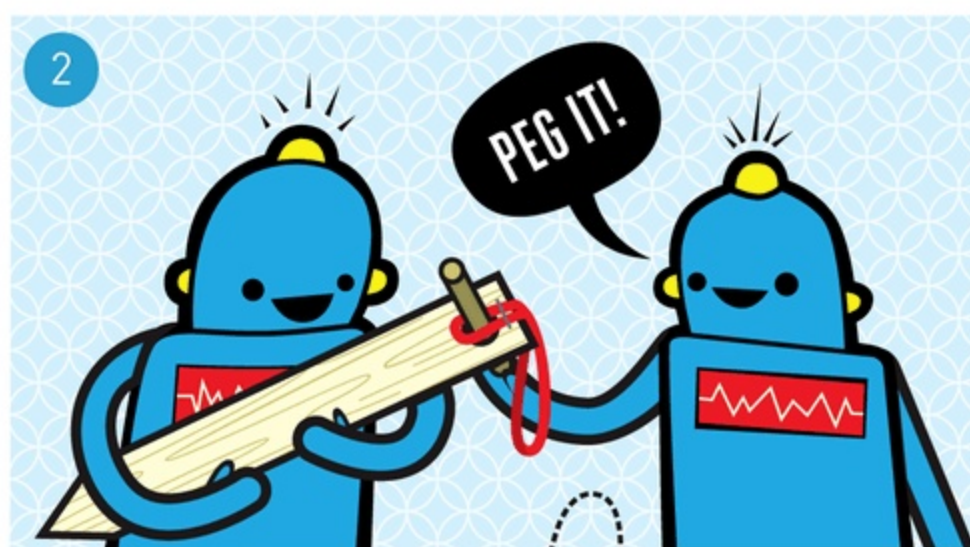

### 2. Secure the rubber band

Feed the dowel through the hole so that one side is flush with the stake and the other protrudes. Next, put the rubber band around the dowel, then staple the rubber band to the wood to keep it in place.

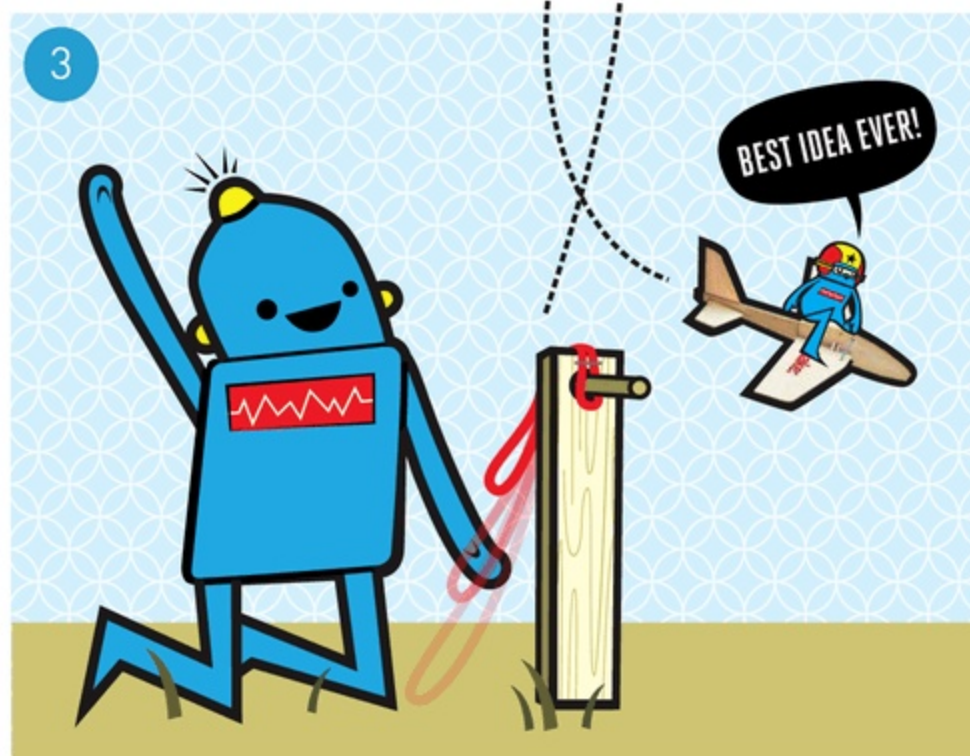

### 3. Pound stake into the ground

Place the stake dowel-side up with a slight angle. Use a piece of scrap wood to protect the top when you hammer it into place. Hang the loose end of the rubber band over the top of the stake.

### Use It

Hook the notch on the bottom of the glider onto the rubber band, pull the plane down along the length of the stake, make sure your face is clearly out of the way, and let it rip! Be sure to launch along the stake, not toward it, or you may break the plane. If wind is a factor, make sure you're launching on the downwind side. With this much stretch, the rubber bands tend to wear out quickly. Keep a supply on hand for quick replacement. 🍌



Watch the launcher in action at [makezine.com/projects/jumbo-hand-launcher](http://makezine.com/projects/jumbo-hand-launcher)

Share it: [#jumbohandlauncher](https://twitter.com/jumbohandlauncher)

### RICK SCHERTLE

([schertle@yahoo.com](mailto:schertle@yahoo.com)) teaches middle school in San Jose, Calif., and designed the Compressed Air Rockets for MAKE Volume 15 and the Rocket Glider for MAKE Volume 31. With his wife and kids, he loves all things that fly.



### You will need:

- » Pine board, 1" x 2" x 4'
- » Small piece of wood dowel or pencil
- » Rubber band, #117, 1/8" x 7"
- » Rocket Glider Maker Shed #MKRS2, or other catapult-launched flying object
- » Saw
- » Drill
- » Drill bit, 1/4"
- » Hammer or mallet
- » Stapler



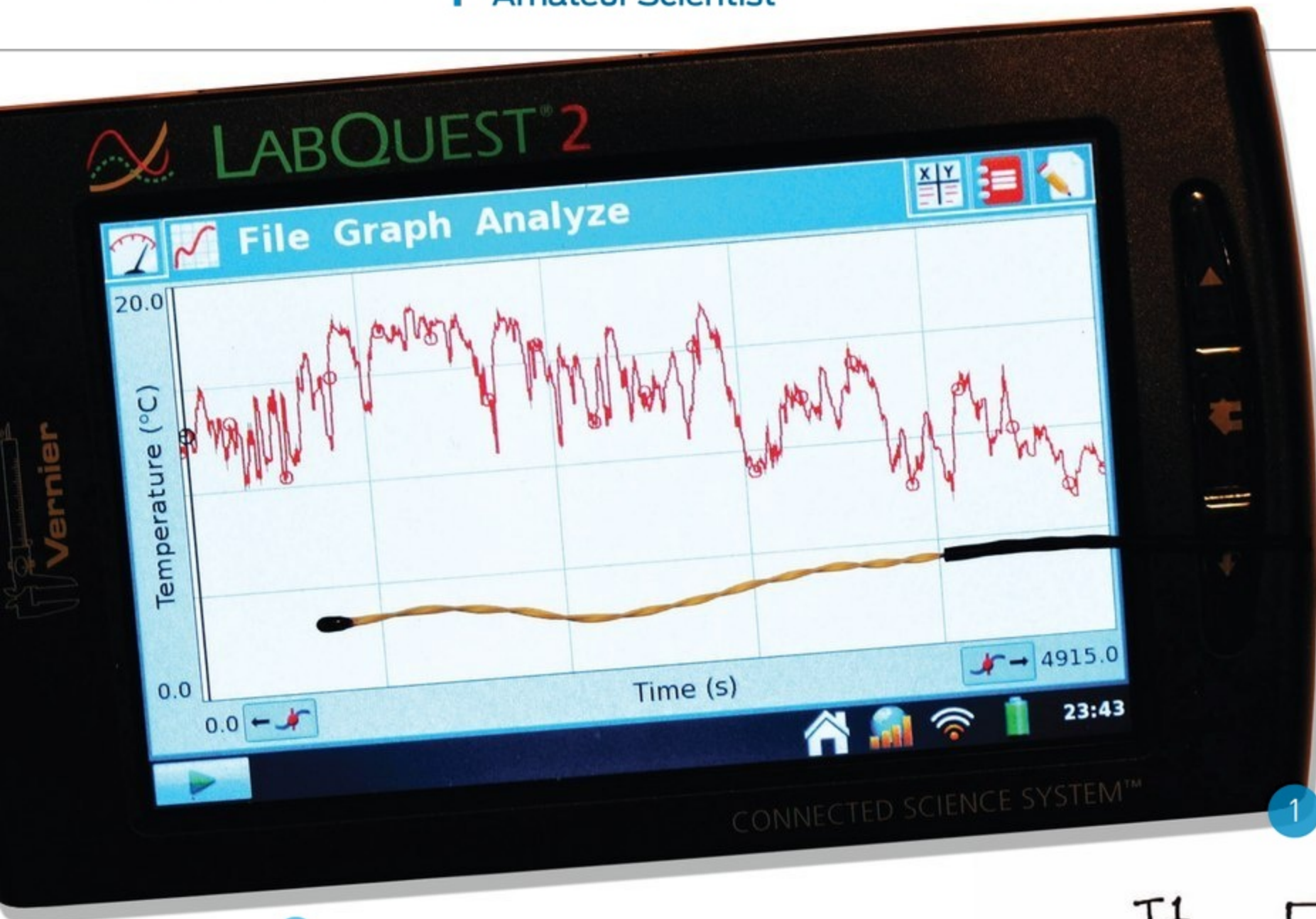

**Time Required:**  
1 Day  
**Cost:**  
\$25-\$350

Measure bubbles of warmth for accurate outdoor temps.

**FORREST M. MIMS III**  
(forrestmims.org)  
an amateur scientist and Rolex Award winner, was named by Discover magazine as one of the "50 Best Brains in Science." His books have sold more than 7 million copies.



# Tracking Heat Islands

Written by  
Forrest M. Mims III

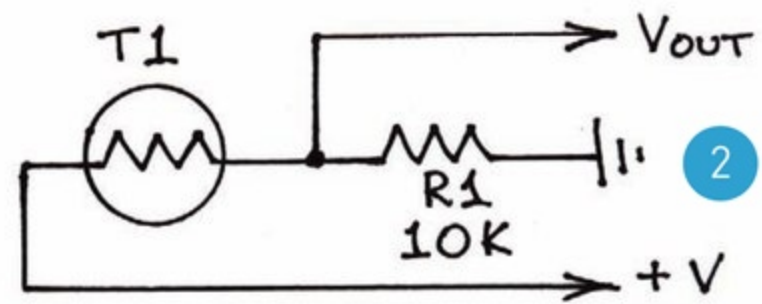

Use data loggers and DIY sensors to map temperatures where you live.

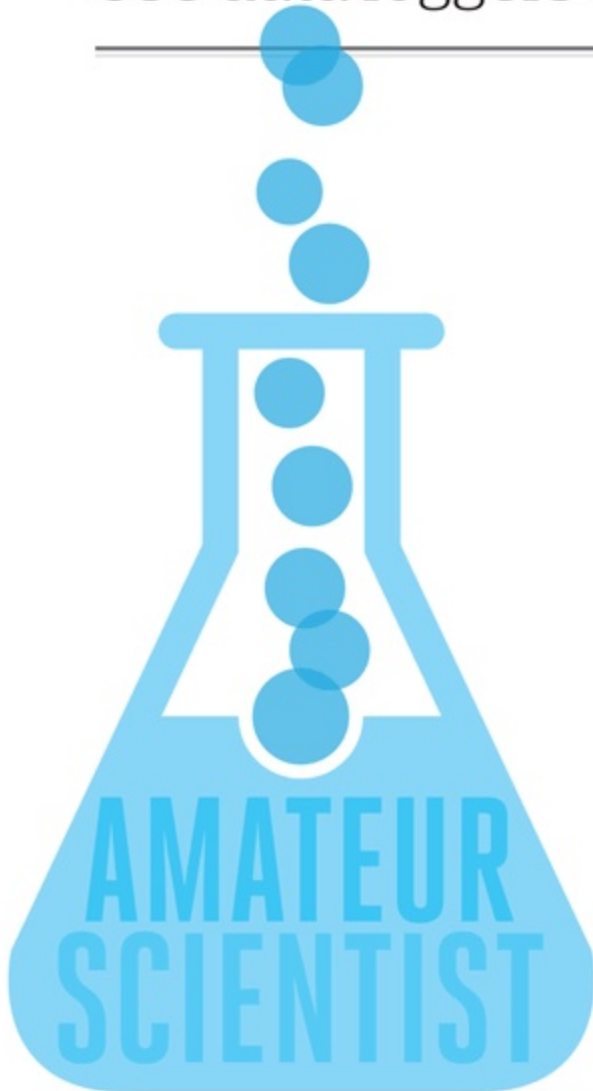

**ACCURATELY MONITORING THE TEMPERATURE OUTDOORS ISN'T EASY.** That's because air temperatures are influenced by virtually anything heated by sunlight, and by engines and other equipment that generate heat.

Bubbles of warmth are known as *heat islands*. They make major contributions to the temperature in and around towns and cities, which are usually warmer than the countryside. The National Weather Service has developed guidelines for placing weather instruments to avoid heat islands (see [makezine.com/cwop](http://makezine.com/cwop)). But with the passage of time, fewer weather stations meet the guidelines, often because of the arrival of new buildings, sidewalks, and paved roads.

## Electronic Thermometers

Stand-alone temperature loggers are

available from Onset Computer, Lascar, Extech, and others. Data are downloaded through USB or optical ports; software converts the data into graphs.

You can modify an Onset Pendant logger for temperature transects by boring an entry hole through its cap and an exit hole in its base, to allow air to flow over the thermistor, a tiny resistor whose resistance varies rapidly with temperature.

While temperature loggers work well, they require you to note times and locations during a transect so you can analyze the data. No notes are needed with a Vernier LabQuest 2 ([vernier.com](http://vernier.com)). This 12-bit, fully programmable logger has three analog inputs for external sensors, and a built-in GPS that records the location of every measurement. Best of all, it displays a real-



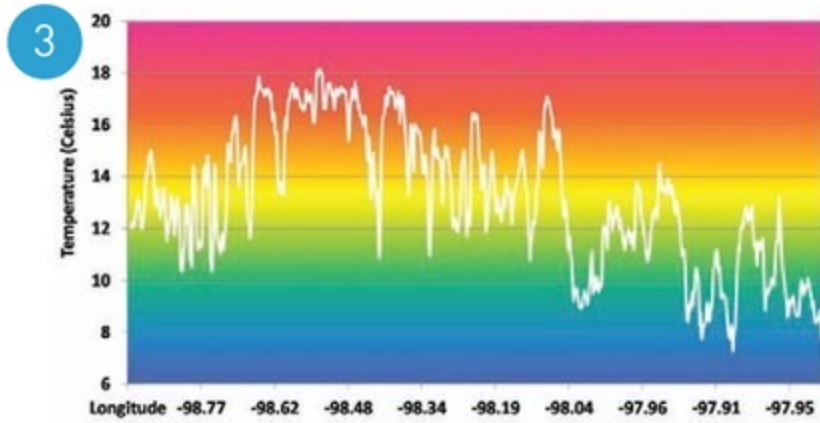

time graph of temperature as it's measured (Figure 1). After making a transect, you can send up to 1,000 measurements to Vernier, which will return a Google map with a color-coded line that indicates the temperature along the route. While the LabQuest 2 is expensive (\$329), mine has become essential. Figure 3 shows my Excel plot of 942 nocturnal temperature measurements across San Antonio, logged with my LabQuest 2 and a thermistor installed on my pickup. Figure 4 shows the same data on the map generated by Vernier.

### Suitable Temperature Sensors

Dedicated temperature loggers have a built-in sensor. The LabQuest 2 works with many external sensors, including a Vernier temperature sensor (\$23).

If you already have a voltage logger, you can use it to measure temperature with the help of a thermistor.

» **Make a DIY temperature sensor** by connecting a 10k $\Omega$  thermistor (Jameco #207037 or similar) in series with a 10k $\Omega$  resistor to form a voltage divider (Figure 2). Connect the free end of the thermistor to the logger's positive voltage and the free end of the resistor to ground. The voltage between the thermistor-resistor junction and ground will be directly proportional to the temperature. You can swap the resistor for a 20k $\Omega$ –50k $\Omega$  potentiometer to adjust the sensitivity of the probe.

### Mounting Temperature Sensors

When mounting temperature loggers on a car, remember that the temperature sensor must be shielded from sunlight. If the car will need to make stops at traffic signs or lights, the sensor should be mounted away from the vehicle to avoid heat buildup from the engine or metal surfaces. Here are some methods I've used:

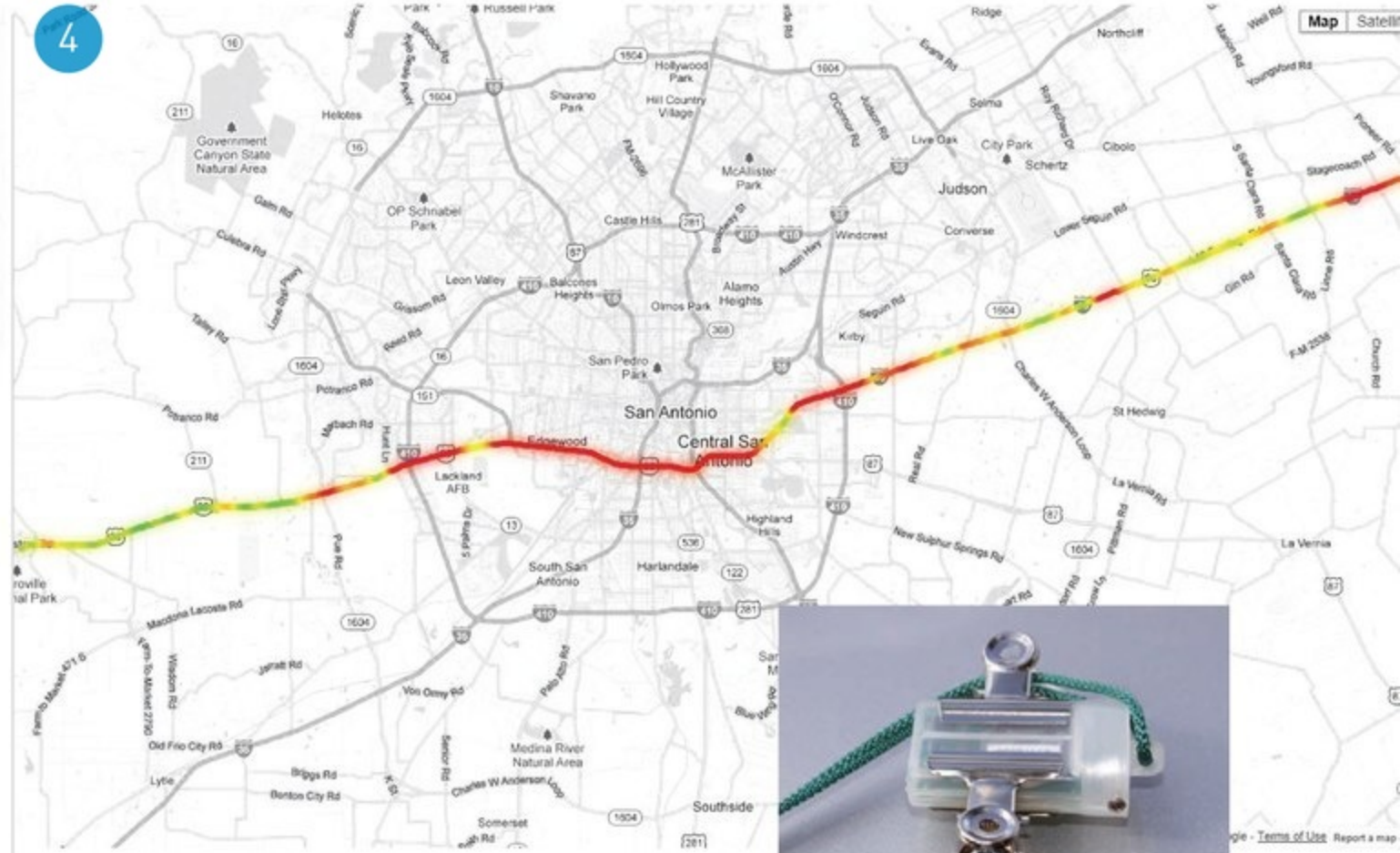

» **Mount an Onset Pendant logger** on a car roof with a pair of Adams suction cup clamps and a safety line (Figure 5).

» **Install an external thermistor in a drinking straw or paper tube** taped to the roof (Figure 6). Insert the sensor into the tube's forward opening, tape its cable to the door frame, and run the cable through the window.

» **Use a car-window flag mount** for an external sensor (Figure 7). Remove the cap and the flag. Extend the sensor just beyond the upper end of the flagpole and secure it by wrapping a few inches of insulated, solid wire around the sensor leads and the groove at the top of the flag mount. Use tape or binder clips to secure the cable to the flagpole.

» **Use 2 feet of 1/2" PVC pipe with a tee fitting** to make a sturdy sensor mount that's shielded from sunlight. Bore a hole through a 3/4" x 9/16" rubber stopper and push the sensor through so that it protrudes 5/16" from the large end. Insert the sensor cable into one end of the pipe and press the stopper in. Bend the free end of the cable back toward the sensor and tape it securely to the pipe. Finally, place a 1/2" tee over the end of the pipe so the sensor is visible through both ends (Figure 8). ⚡

Study heat islands for a science fair project. Learn more at [makezine.com/uhi](http://makezine.com/uhi) Find this project online and add your comments at [makezine.com/trackingheatlands](http://makezine.com/trackingheatlands) Share it: [#trackingheatlands](https://twitter.com/trackingheatlands)

5

6

7

8

**CAUTION:** MAKE SURE YOUR TEMPERATURE SENSOR IS SECURELY MOUNTED TO YOUR VEHICLE AND DOESN'T POSE A HAZARD TO OTHER DRIVERS OR BECOME A DISTRACTION TO YOUR DRIVER. COME TO A COMPLETE STOP IN A SAFE AREA BEFORE MAKING ANY CHANGES TO THE EXPERIMENT.



# The Chameleon Bag

Make an interactive messenger bag that reacts to your RFID-tagged objects.

Written by Kathryn McElroy



**KATHRYN McELROY** is a designer and photographer living in NYC. She's in her thesis year of an MFA in Products of Design at the School of Visual Arts. Kathryn is a talented maker in many mediums including: sewing, electronics, baking, papercraft, and graphic design.



**THE CHAMELEON BAG IS AN INTERACTIVE MESSENGER BAG WITH A REACTIVE FRONT PANEL.** I wanted the bag to display animations and patterns across its front flap as the user places different RFID-tagged objects into it, and I accomplished this by combining a Boarduino microcontroller and an RFID reader inside the bag, along with 49 RGB LEDs on its front flap.

Designed into the coding are three specific uses, with potential for more. First, the bag keeps track of the RFID-tagged items placed inside and warns the user through light displays if an important item, such as keys or cellphone, is missing. Alternately, the lights can change color to match clothing or accessories embedded with RFID tags. And finally, it can be programmed to display cheery animations when a favorite totem with an RFID tag is placed in the bag, enabling the user to

share her good mood with the people around her. Since the user has access to the microcontroller, she can code additional uses to change the colors and animations of the display.

## 1. Set up the electronics

**1a.** First, solder your Boarduino following the directions at Adafruit ([makezine.com/adafruit-boarduino](http://makezine.com/adafruit-boarduino)). Connect it to the computer using the FTDI cable; the colored wires with female headers go onto the back wall of pins (black goes to ground, for orientation).

**NOTE:**  
IF YOU'RE HAVING TROUBLE PROGRAMMING THE BOARDUINO, TRY MOVING THE JUMPER OVER ONE PIN.

Open the project code in the Arduino IDE software, select Tools → Board, and select Duemi-



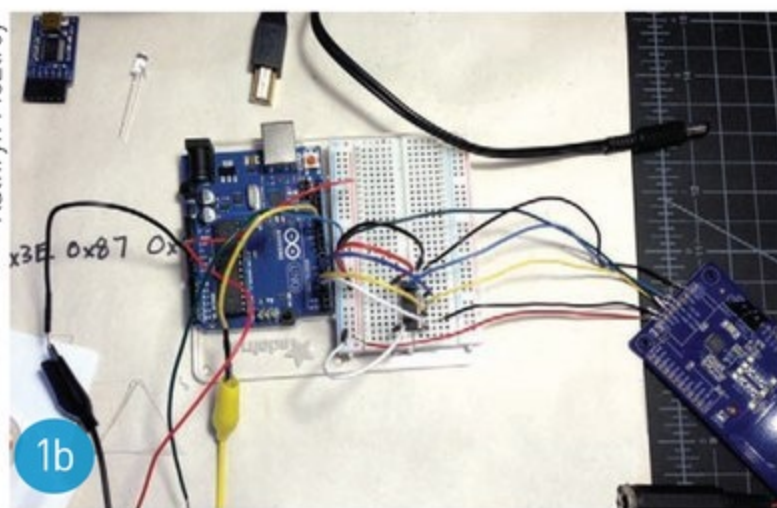
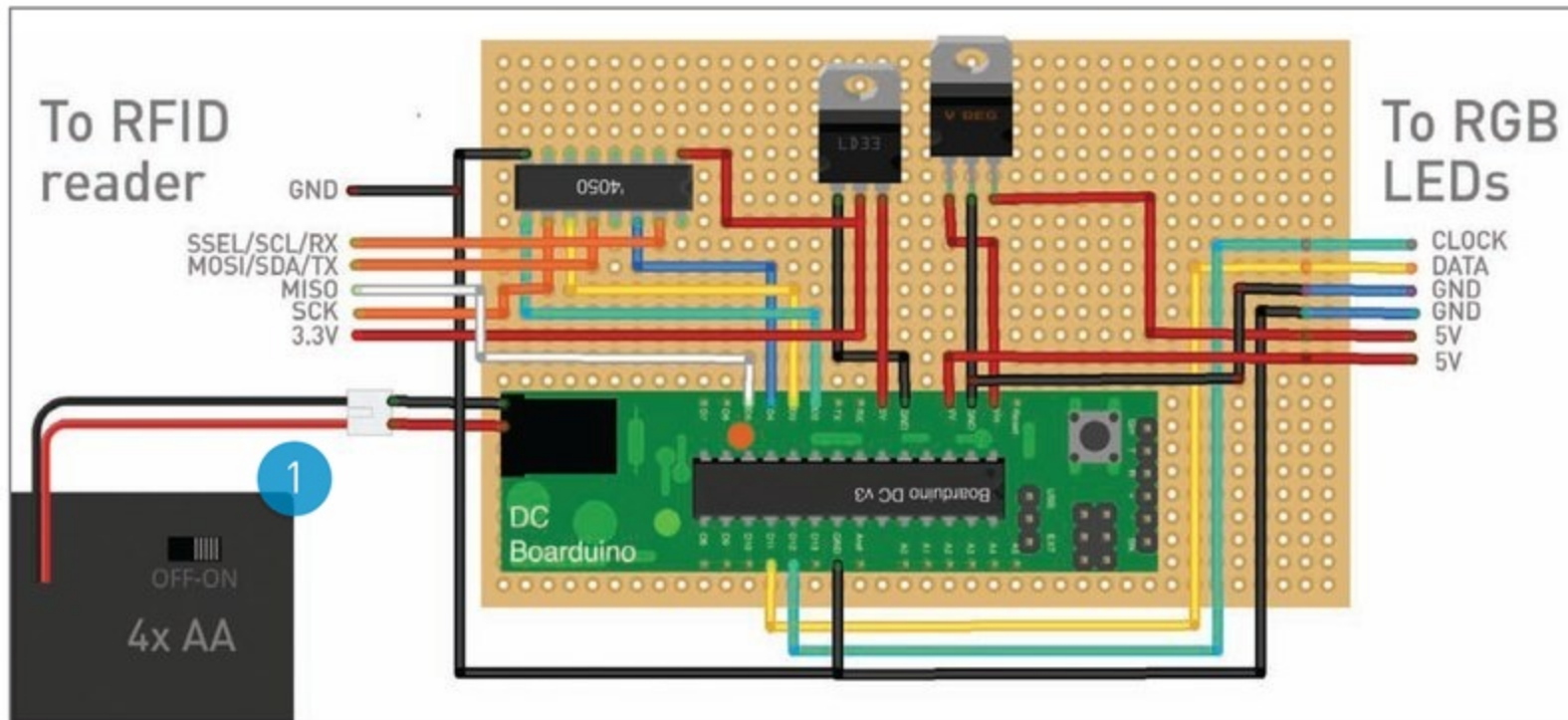

lanove with ATmega328. Upload the code to the board and launch the Serial Monitor by clicking the icon in the upper right-hand corner. It should tell you that no RFID reader is attached.

**1b.** Next, set up the RFID reader using the Adafruit tutorial ([makezine.com/adafruit-rfid-tutorial](http://makezine.com/adafruit-rfid-tutorial)). Solder the two 3-pin strips, but don't solder the 8-pin strip. Follow the directions to connect the RFID reader to the included 4050 level-shifter pin. Mount the 4050 onto the small breadboard, and temporarily connect it to the RFID reader and to the Boarduino with jumper wires, using **Figure 1** for reference.

**1c.** Now you'll test the RFID reader with some RFID tags. First, reload the code and open the Serial Monitor. It should now recognize that the reader is attached; if not, check your connections.

**1d.** Each RFID tag has a unique number, and you'll see these numbers flash onto the Serial Monitor when you place a tag within 4" of the reader. Copy and paste these tag numbers into a text document for reference. In the project code, about halfway down, change the `cardidentifier` variables to your unique tag numbers to choose what animation or colors you'd like to see when the reader reads that number. Then reload the code to your

Boarduino. Now you can label your RFID tags to keep track of which tag launches which display.

**1e.** You're ready to set up the RGB LEDs. Refer to the Adafruit tutorial ([makezine.com/adafruit-rgb-led](http://makezine.com/adafruit-rgb-led)) for the specific wires. You'll need to power the LEDs with the 5V plug-in power supply while testing so they don't try to pull 5V through the Boarduino. Connect the other wires temporarily to the Boarduino as outputs. With the Serial Monitor open, test the RGB LEDs by trying the tags you've assigned colors to. You may need to troubleshoot if something is not properly connected.

**1f.** Once you've gotten all the components to work together, you're ready to make these connections permanent! Arrange all your components onto a 2"×4" protoboard. Use the 16-prong socket for the RFID reader's 4050, and two 15-pin strips of female headers to make a strip for each side of the Boarduino. Solder the socket and female headers in place. Solder all the connections between the 4050 and the Boarduino.

**1g.** Cut extra long wires for the connection between the 4050 and the RFID reader, and solder the wires to the protoboard, waiting to attach the reader until we determine the length we need. Cut extra long wires for the RGB LEDs as well, about twice as long as the RFID wires.

**1h.** Now you can solder the power connections for the RGB LEDs and the RFID reader. We'll be using 4 AA batteries for our power supply to the Boarduino. The RFID reader needs 3.3V, so connect one of the 5V pins to the 3.3V voltage regulator, then connect it to the 4050 and the reader. The LEDs need 5V connected to 2 different wires; since there is only one 5V pin left, connect that to the RGB LEDs, then connect the `Vin` (total voltage from the

## Time Required:

**6-8 Hours**

## Cost:

**\$180-\$200**

Solder up the electronics, then brush up on your sewing to make this spectacular bag.

## Materials

- » **Boarduino microcontroller** Adafruit Industries item #91, [adafruit.com](http://adafruit.com)
- » **FTDI cable, USB, 3.3V**
- » **RFID reader** Adafruit #364
- » **Breadboard, small** for testing
- » **RGB LED strips (2)** Adafruit #738
- » **Power supply, 5V DC** for testing
- » **RFID tags** Adafruit #365
- » **Protoboard, 2"×4"**
- » **Female headers, 0.1"**
- » **DIP socket, 16-pin, 0.3"**
- » **Voltage regulator, 3.3V, LD1117V33**
- » **Voltage regulator, 5V, 3A, 3-pin**
- » **Battery holder, 5V, 4xAA**
- » **Jumper wires** for testing
- » **Luan plywood, 1/8"×11"×14"**
- » **Electrical tape**
- » **Upholstery foam, 1"×26"×20"** non-yellowing

## FOR THE BAG:

Alternately, you can repurpose an existing messenger bag.

- » **Canvas, gray, 2 yards**
- » **Canvas, white, 1 yard**
- » **Thread, gray and white**
- » **Magnetic snaps (2)**
- » **Metal loops, 2" (2)**
- » **Metal slide, 2"**
- » **Zipper**

## Tools

- » **X-Acto knife**
- » **Computer with Arduino IDE** free download from [arduino.cc](http://arduino.cc)
- » **Laser cutter or drill**
- » **Foam cutter**
- » **Soldering iron and solder**
- » **Sewing machine**

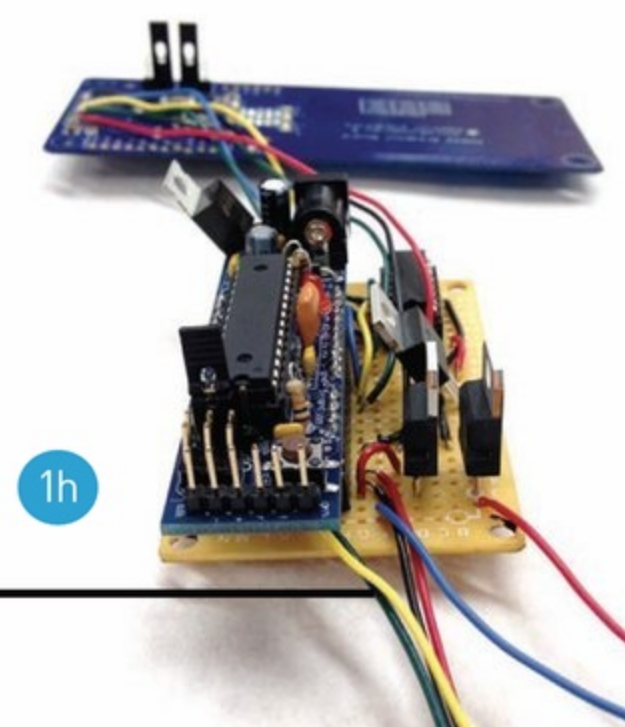





2

batteries) to a 5V regulator before connecting it to the other power wire.

### 2. Sew a bag or repurpose one

When you want a break from the electronics, start sewing the messenger bag — or repurpose an existing bag — following the instructions and templates at [makezine.com/chameleon-bag](http://makezine.com/chameleon-bag).

### 3. Assemble

**3a.** Using the downloadable template (at the URL above), laser-cut or drill holes in the thin plywood to fit the RGB LEDs and hold them in place in a grid pattern. (If you're repurposing a bag, adjust the template to fit into your bag's front flap.) Then push each LED into a hole, and use electrical tape on the backs to hold them in place.

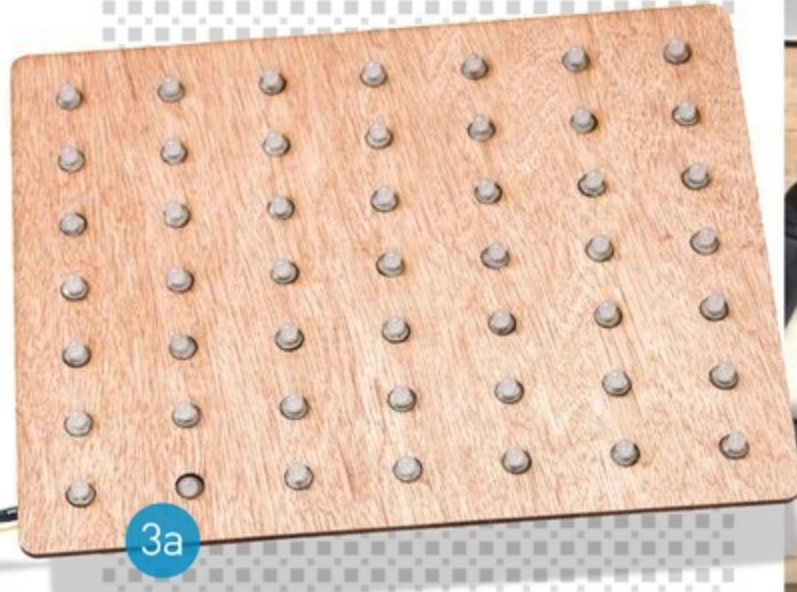

3a



3c

**3b.** Cut your upholstery foam into two 13"×10" rectangles (or the size of your repurposed bag), one for the back panel and one for the front panel that will cover the LEDs. On the back foam panel, cut out cavities (not all the way through) to hold the electronics. On the front foam panel, use an X-Acto knife to cut Xs where the LEDs will push into the foam. The foam will diffuse the LEDs' colors and make them flow together.

**3c.** Insert the electronics in the spaces you cut out in the back foam panel, then trim and solder the wires to the RFID reader. Cover the LED board with the front foam panel and insert it into the white front flap of the bag. Measure where the other half of the magnetic snaps should go on the bottom of the front flap and attach them. Measure and finalize the wire lengths from the Boarduino to the LEDs, take the electronics out of the bag, and solder the final wires in place.



3d



**3d.** Put all the electronics back into their respective bag parts. Insert the front flap's extra fabric down into the back of the bag.

Fold the raw edges of the back panel into itself and pin everything together. Sew the panel together, taking care not to damage the electronics or break your machine's needle on the LED wires.



3e



**3e.** Unzip the back zipper, insert the battery holder, plug it into the Boarduino, and test. Now your Chameleon Bag can tell what's missing, express how you're feeling, or just match your outfit. 🌈

Get busy with the project code, downloadable templates, sewing instructions, and video at [makezine.com/chameleon-bag](http://makezine.com/chameleon-bag)

Share it: [#chameleonbag](https://twitter.com/chameleonbag)



# Toy Inventor's Notebook

## ANT-FREE FEEDER

Invented and drawn by Bob Knetzger

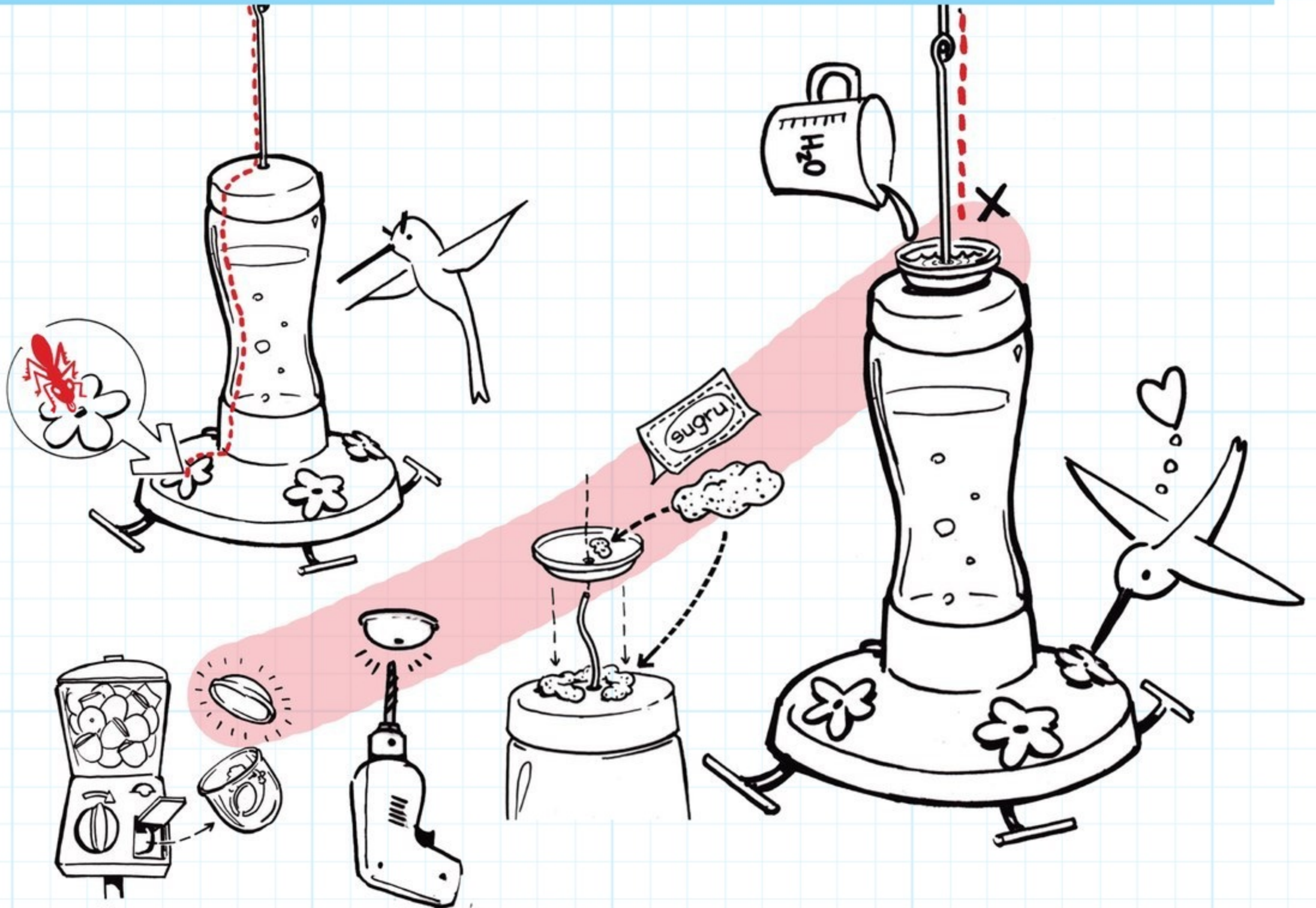

**OUR BACKYARD HUMMINGBIRDS WERE NOT HAPPY!** A trail of hungry ants was climbing into our hummingbird feeder, fouling the sugar water, and keeping the birds away. The ants were undeterred by folk remedies like bay leaf barriers, and pesticides were out of the question. Ugh — but what to do?

My bin of toy parts yielded the answer. Drill a hole in the cap from a **plastic vending-machine toy capsule**. Attach the inverted cap on top of the feeder with a bit of **Sugru or bathroom caulk**. Use another dab to seal up the center hole and hanging wire. When filled with **water**, the cap makes a tiny water moat the ants refuse to cross. The hummingbirds are back enjoying the feeder — sweet! 🍯

See it work: [makezine.com/ant-free-feeder](http://makezine.com/ant-free-feeder)

Share it: [#antfreefeeder](https://twitter.com/antfreefeeder)

### SUGRU IS A HANDY SUBSTANCE

It molds like putty and cures at room temperature to form a strong, flexible silicone rubber that can be used to fix, protect, improve, and innovate.



MAKE THINGS CHILD-PROOF AND GRIPPY  
Joel Veitch, England



BOUNCE-PROOF YOUR CAMERA  
Stefan Stocker, Germany



MAKE A PLUG HUB FOR YOUR LAPTOP  
Johan Frick, Sweden

Sugru is available in the Maker Shed: [makezine.com/go/sugru](http://makezine.com/go/sugru)





# Enough Already!

## The TV Celebrity Silencer



Peter O'Toole

**Time Required:**  
3 Hours  
**Cost:**  
\$75-\$100

Build it and you'll never hear the word *Kardashian* again.

**MATT RICHARDSON**

MAKE contributing editor Matt Richardson ([mattrichardson.com](http://mattrichardson.com)) is a Brooklyn-based creative technologist and Resident Research Fellow at ITP.



**Materials**

- » **Arduino Uno microcontroller**  
Maker Shed item #MKSP99, [maker-shed.com](http://maker-shed.com), or compatible controller
- » **Power supply for Arduino**  
Maker Shed #MKSF3
- » **Video Experimenter Shield** by Nootropic Design, Maker Shed #MKNTD7
- » **Composite video cables (2)**
- » **Infrared LED** such as Adafruit #387, [adafruit.com](http://adafruit.com)
- » **Infrared sensor** such as Adafruit #157, for IR tutorial
- » **Breadboard and jumper wires**  
Maker Shed #MKKN2 and MKSEED3, for IR tutorial

**Tools**

- » **Computer with Arduino IDE software** free download from [arduino.cc](http://arduino.cc)
- » **USB cable, Standard-A to Standard-B** for programming Arduino
- » **Screwdriver, small flat-head**

Take control of your TV by using an Arduino to mute annoying celebrities automatically. *Written by Matt Richardson*

**I'M SICK OF HEARING ABOUT OVEREXPOSED PERSONALITIES LIKE KIM KARDASHIAN AND SARAH PALIN**, so I came up with this Arduino-based solution to mute my TV anytime these celebrities are mentioned. I call it the Enough Already. It reads the closed-captioning text that's piggy-backed on your TV signal, scanning for whatever keywords you choose. Build one and it can mute the audio whenever your keywords appear — or even turn off the TV altogether!

**1. Set it up**

- 1a.** Place the Video Experimenter Shield onto the Arduino.
- 1b.** Using a composite video cable, connect your video source output to the video input on the shield. Connect the video output from the shield to the video input on your television.
- 1c.** Set the Output Select switch on the shield to "Overlay."



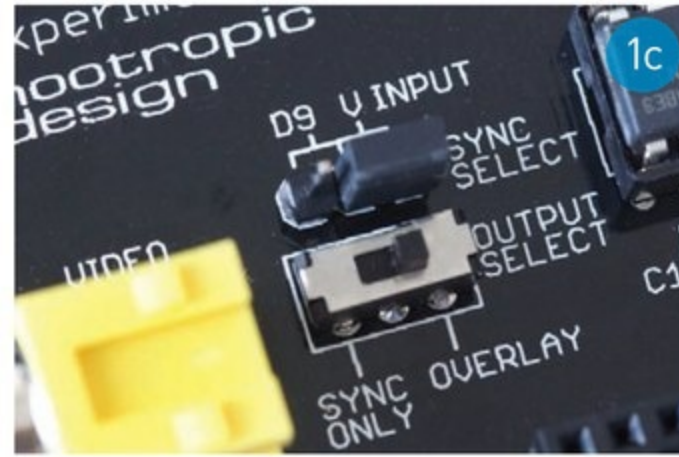
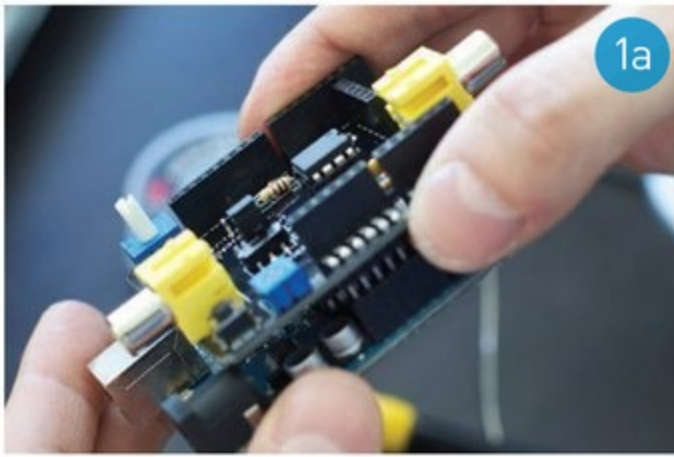

**1d.** Download Nootropic Design's Enhanced TV Out Library ([nootropicdesign.com/ve/#library](http://nootropicdesign.com/ve/#library)), unzip it, and drop it into the *libraries* folder that's in your Arduino folder.

**1e.** Download the project code from [makezine.com/enough-already](http://makezine.com/enough-already) and open it in the Arduino IDE.

**1f.** Enable your television's closed captioning to ensure that your video source is sending closed captioning data. (Not all broadcasts will transmit closed captioning.)

**1g.** Upload the code to the Arduino. Open the Serial Monitor and set the baud rate to 57,600 bps.

**1h.** Adjust the larger potentiometer on the shield until you see the flickering bits displayed on the top of your TV screen.

**1i.** Check the Serial Monitor and you'll see the text coming in. (Imagine what else you could do with this data!) Adjust the smaller potentiometer with your screwdriver if the formatting of the text looks odd, or if you see other data such as the title of the program.

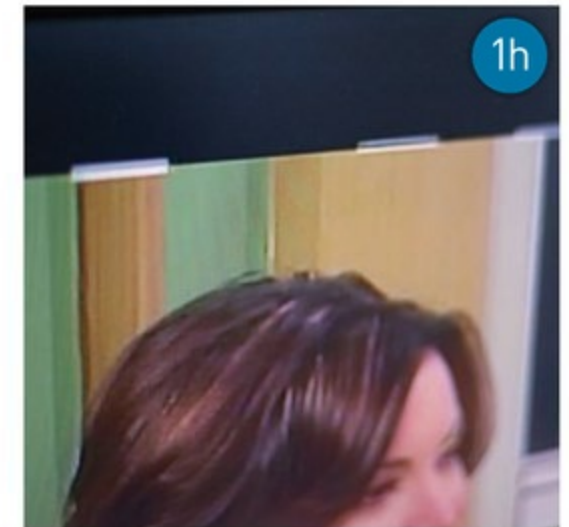
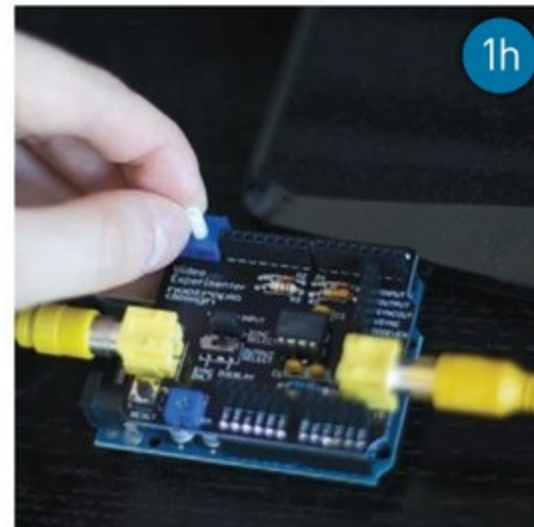

## 2. Learn your IR mute command

Adafruit Industries has an excellent tutorial on how to use infrared commands with your Arduino. You just need a breadboard, an IR sensor, some jumper wires, and your TV remote control. Follow along at [makezine.com/adafruitir](http://makezine.com/adafruitir) to adjust the project code's `SendMute()` function to match your TV remote's mute command.

## 3. Put it all together

**3a.** In the `keywords` array near the top of the Arduino sketch, change the keywords that you want to mute. Be sure to also change the value for `NUMBER_OF_KEYWORDS` so that it matches the number of keywords you're searching for. Upload the code to your Arduino.

**3b.** Connect the anode of the IR LED (longer lead) to pin 13 and the cathode (shorter lead) to ground.

**3c.** With the composite video cable from your video source going into your Video Experimenter Shield, connect a power supply to the Arduino, and your Enough Already is ready to go. Point the infrared LED toward your television and enjoy the silence! 🤫

```

WHETHER THEY WANT TO TESTIFY
AGAINST YOU OR NOT.
IF THE PROOF IS THERE THAT YOU
DID IT, THEN YOU GO TOAIL.
>> THERE ARE A FEW CHEARGES
THEY'RE LOOKING AT.
>> I JUST WANT TO GIVE A FEW
FACTS.
THE MOTHER IS ALSO BEING
INVESTIGATED, BEING ARRESTED.
>> RIGHT
>> BECAUSE HER MOTHER WAS
SOMEHOW INVOLVED WITH THE TEXT
MESSAGING.
EACH OF THEM COULD GET FIVE
YEARS, IT COULD BE THAT SHE EVEN
GETS TENYEARS.
WHAT IS INTERESTING WHATOU
  
```

Ready to decode IR!

```

Received:
OFF ON
58272 usec, 280 usec
1760 usec, 300 usec
720 usec, 280 usec
740 usec, 280 usec
720 usec, 300 usec
720 usec, 280 usec
1760 usec, 300 usec
1740 usec, 300 usec
1760 usec, 280 usec
720 usec, 300 usec
1760 usec, 280 usec
720 usec, 300 usec
720 usec, 300 usec
  
```

+ More on how to use closed-captioning data: [makezine.com/evertzcc](http://makezine.com/evertzcc) and [makezine.com/nootropiccc](http://makezine.com/nootropiccc)

To shut them up, get the project code and full illustrated step-by-step instructions at [makezine.com/enough-already](http://makezine.com/enough-already).

Share it: [#enoughalready](https://twitter.com/enoughalready)





# Bass Bump Headphone Amp

Build this circuit to boost low frequencies and make your MP3s go boom.

Written by  
Ross Hershberger

**Time Required:**

**A Weekend**

**Cost:**

**\$80-\$100**

## ROSS HERSHBERGER

has worked as a mainframe programmer, tooling machinist, restorer of vintage tube amps, custodial equipment technician, and several other unlikely jobs. Since 2012 he has worked as a YAG Laser Field Service Engineer for the North American division of Trumpf GmbH.



Jeffrey Braverman

**THE BASS BUMP HEADPHONE AMP WILL IMPROVE ALL YOUR PRIVATE MUSIC LISTENING.** The custom bass-enhancement circuit lets you boost the music's critical low-frequency spectrum to your taste, and it has enough power to give clear sound and punchy dynamics through most any headphones, or even small speakers.

This amp sounds better than the headphone driver circuits in most smartphones and MP3 players because it has a lower source impedance and much higher drive current. This means the sound from your headphones is unaffected by long cables or impedance mismatches. Build one and

you'll hear the difference right away.

You'll solder the circuit on a twin perf-board to create two identical channels — left and right — each adjusted by its own bass control potentiometer. Each channel splits the low from the high frequencies at about 100Hz, passes the low through the adjustable boost, then recombines them before feeding them into the amplifier chip. At the output, a Zobel network keeps the impedance low at high frequencies and damps any oscillations. It's all done with a handful of resistors, capacitors, and two LM386 audio amplifier chips. All the parts are easily sourced at RadioShack.

I chose the LM386 because it's easy to

build with — it's widely available, will run on a single power supply as low as 5V, and requires few external components. There are higher-performance amp chips, but they'd require a dual power supply, making the circuits much more complex. The LM386 performs well and keeps it simple.

The Bass Bump Headphone Amp is powered by a rechargeable battery for mobile use, but you can also power it via USB using a custom cable. We can show you how to make that too. 🛠️

Put some bottom in it! Full instructions and schematic at [makezine.com/bass-bump-headphone-amp](http://makezine.com/bass-bump-headphone-amp)

Share it: [#bassbumpheadphoneamp](https://twitter.com/bassbumpheadphoneamp)

## More Great Projects with the LM386 Amp Chip at [makezine.com/projects](http://makezine.com/projects)



### MonoBox Powered Speaker

A mobile amplified speaker for any smartphone or music player.

### Infrared String Bass

Build an optical pickup and rock this unique 4-string bass guitar.

### Raygun Vector Weapon

Pew pew! Build this sound toy from scratch or from our kit ([makershed.com](http://makershed.com) #MSVWP).





# 1 2 3 Self-Filling Pet Water Bowl

Written by Skyler Tiffin ■ Illustrations by Julie West

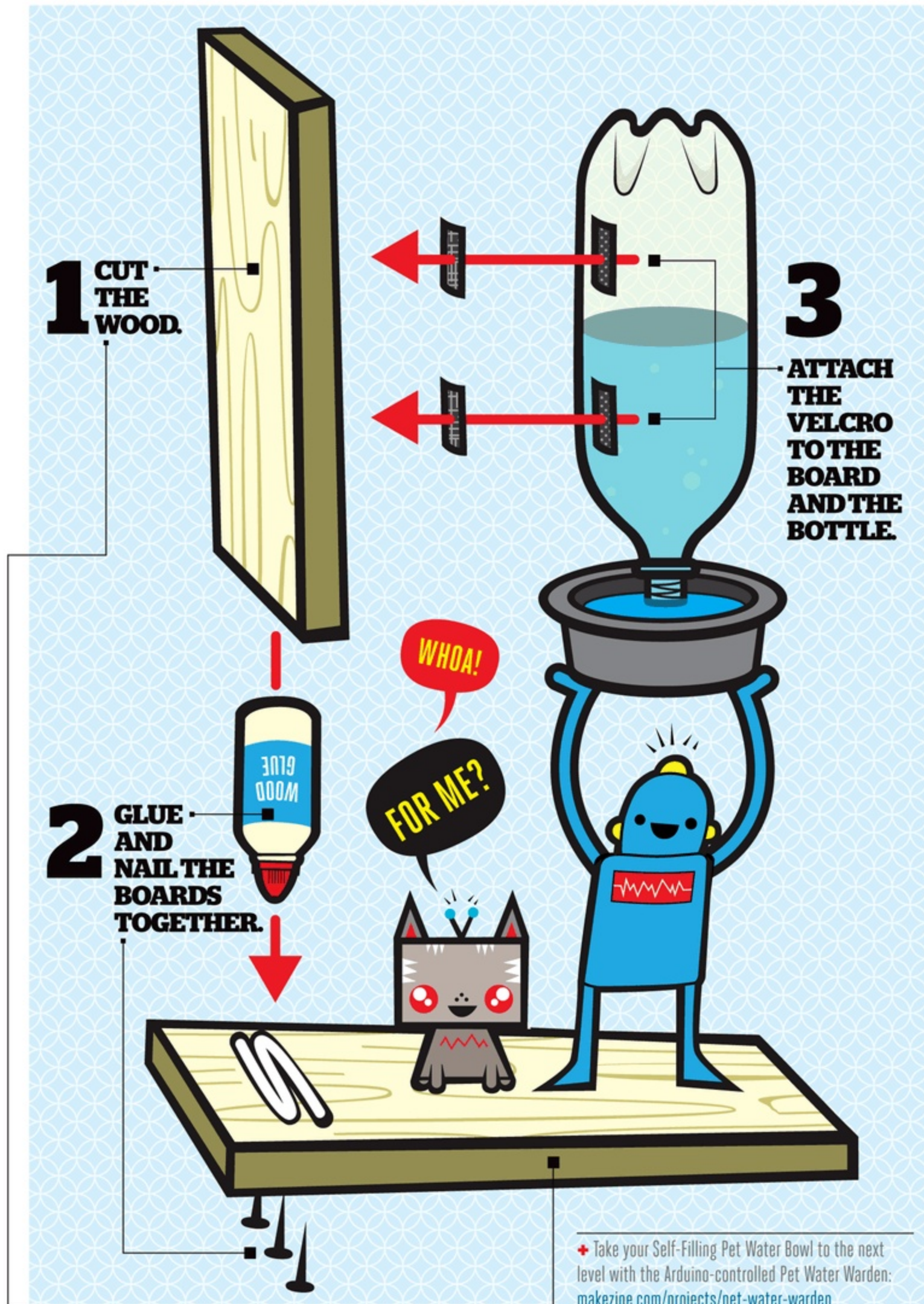

**SKYLER TIFFIN**

is a 12-year-old student at The Harley School in Rochester, NY. She enjoys being creative, building things, and playing sports like soccer and basketball.

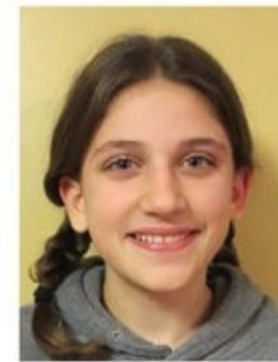

I WAS TIRED OF HAVING TO FILL UP MY DOG'S WATER BOWL TEN THOUSAND TIMES A DAY, so I decided to make what I call the "Awesomest Coolest Easiest Water Bowl for Cats and Dogs." This bowl re-fills by itself, and all you need is wood, a two-liter bottle, velcro, and a thirsty pet.

I once saw my dad do experiments with this "magic bottle." He put water into it, turned it over a bowl, and when the bottle touched the surface of the water, the water stopped streaming and the bowl didn't overflow. At the time I was amazed. Years later, I figured out how it works and thought it would be a good idea for the dog dish. When I first put it together, I was so proud of myself, until I heard a loud thump from the kitchen. When I investigated, my dog had a wild look on his face and the two-liter bottle was in his dish. I fixed this problem by not filling the bottle all the way and super-gluing the velcro to the wood. It has been many weeks since it fell, and I think that's a good sign! 🐾

+ Take your Self-Filling Pet Water Bowl to the next level with the Arduino-controlled Pet Water Warden: [makezine.com/projects/pet-water-warden](http://makezine.com/projects/pet-water-warden)

For the full build instructions, check out [makezine.com/self-filling-water-bowl](http://makezine.com/self-filling-water-bowl)

Share it: [#selffillingwaterbowl](https://twitter.com/selffillingwaterbowl)



# Bamboo Hors d'Oeuvre Tray

A few clever cuts and you'll be serving in style. *Written by Phil Bowie and Larry Cotton*



**Time Required:**  
**A Weekend**  
**Cost:**  
**\$10-\$15**

**PHIL BOWIE**

is a lifelong freelance magazine writer with three suspense novels in print. He's on the web at [philbowie.com](http://philbowie.com).

**LARRY COTTON**

is a semi-retired power-tool designer and part-time math instructor who loves music, computers, electronics, furniture design, birds, and his wife — not necessarily in that order.

**SOMEWHERE BETWEEN GRASS AND WOOD ON GOD'S CELESTIAL MATERIALS LIST, BAMBOO IS EXCEPTIONAL STUFF.** Lightweight, strong, elastic, and durable, it's one of mankind's earliest building materials. It works, bonds, and finishes well. It's such a perfectly renewable resource that you can almost watch it grow — often between 2 and 4 feet a day.

Here's an eye-catching hors d'oeuvre tray you can make with just bamboo, a little glue, and a few clever cuts. Bamboo poles are available from such sources as [calibamboo.com](http://calibamboo.com) or [bambooandthatchetc.com](http://bambooandthatchetc.com), or you may find some growing locally. Harvest it after it loses its foliage and thoroughly dries to a nice beige.

You'll need about 6 running feet to yield four

9" pieces that each include a node, with 5½" of hollow tube on one side of the node and about 3½" on the other. You'll split these lengthwise, then make three simple jigs from scrap: a cutting guide for the 45° angles needed, a thickness gauge to even up the segments, and a peg for fitting and gluing the segments together. Then just sand your tray and finish it with food-safe polyurethane.

The tray is perfect for serving party snacks, and it also makes an interesting wall decoration, hung either side out, when you're not using it to feed your hungry, green-minded friends. 🍷

Build it! Full instructions and photos at [makezine.com/bamboo-hors-doeuvre-tray](http://makezine.com/bamboo-hors-doeuvre-tray)

Share it: [#bamboohorsdoeuvre tray](https://twitter.com/bamboohorsdoeuvre tray)

**More Fun Bamboo Projects:**

[makezine.com/projects](http://makezine.com/projects)



**Bundle Bow and Arrow**

Split and lash bamboo to make a real bow and arrow for little ones.



**Safe Bamboo Swords**

Nearly indestructible, padded with foam and duct tape for battle.



**Greener Surfboard**

"Fiberglass" this board with bamboo fiber cloth and epoxy resin.



# Mini Blind Minder

Opening and closing your blinds constantly? Build this gadget to enslave your slats and tame the sun. *Written by Steve Hoefler*

**Time Required:**  
1-2 Days  
**Cost:**  
\$40-\$60

**STEVE HOEFER** is the inventor of MAKE's popular Secret-Knock Gumball Machine, Indestructible LED Lanterns, and other projects – and the host of the MAKE Inventions video series.

**SOMETIMES THE SUN IS MY FRIEND, WARMING THE HOUSE ON COLD DAYS.** Other times it's my enemy, warming the house on hot days. It seems no matter how I set my window blinds, I come home to a sweltering or freezing house.

So I built this Mini Blind Minder to open and close them automatically. It's powered by an Arduino microcontroller, which uses a sensor to read the room temperature and then activates a servomotor to open the slats when it's too cool and close them when it's too warm. It has an adjustable thermostat, and it can also be operated manually with a push of a button.

To make it, you'll solder a custom Arduino "shield" — a circuit board with headers that plug into the Arduino — and calibrate the servo with 2 easy test programs I wrote, then mount it all in a tidy RadioShack project case. It's only a moderate amount of soldering, easily built in a weekend.

After you upload the Mini Blind Minder code to the Arduino, just count how many turns of your window-blind wand it takes to close the slats, then adjust the trimpot on your circuit board until pressing the Down button rotates the servo the correct number of rotations to close them. Now your Minder is matched to your blinds.

Finally, install the Minder to your window frame and make a simple slip clutch by looping a rubber band around the wand and 2 of the spokes of the servo horn. That's it!

## How It Works

- » In Manual mode, the LED turns white and you operate the blinds by pushing Up or Down buttons.
- » In Automatic mode, the Minder opens and closes the blinds based on room temperature. The LED indicates room temperature in relation to the thermostat setting: green when it's the same temperature, red when the room is hotter, blue when it's colder. Up and Down buttons set the thermostat between 10°C (50°F) and 30°C (86°F).
- » When it's powered off, the Minder automatically remembers the thermostat temperature and the position of your blinds. 🔄

Get complete build instructions, code, and video at [makezine.com/projects/mini-blind-minder](http://makezine.com/projects/mini-blind-minder)

Share it: [#miniblindminder](https://twitter.com/miniblindminder)

Jeffrey Braverman



## More Home Automation Gadgets at [makezine.com/projects](http://makezine.com/projects)



### Potted Plant Protector

Connect sensors to an Arduino to keep your plants warm, watered, and well-lit.



### Pet Water Warden

Keeps your furry friends' water supply topped up while you're away — and it'll send a tweet if it runs out!



# GPS Cat Tracker

Find out exactly where kitty wanders all day. *Written by Ken Burns*

## Time Required:

**1–2 Hours**

## Cost:

**\$140–\$160**

## KEN BURNS

is an engineer, programmer, and longtime electronics hobbyist living in Akron, Ohio. He is the founder and president of TinyCircuits, which develops miniature open-source electronic circuits.



Guther Kirsch

**IF YOU HAVE AN OUTDOOR CAT OR DOG**, you've probably wondered where it goes during the day. Do they just hang around outside the house, or do they go on long adventures exploring the neighborhood? To snoop on my cat Conley, I made a GPS cat-tracking collar that would log his location during the day, then let me download the data to a computer when he gets back home.

At the core of this collar is a TinyDuino microcontroller and a few of the expansion TinyShields that are available for this platform. The TinyDuino works just like the Arduino Uno and can run the exact same sketches, yet it's only the size of a quarter. You can easily add capabilities just by plug-

ging TinyShields into it — I used the GPS TinyShield to get the position data and the microSD Card TinyShield to log the data.

To power the system, you need a small, light battery with the capacity to run the system long enough to get useful data. The GPS and SD card writes are fairly power-hungry, so I use a small lithium-ion rechargeable battery that provides up to 6 hours of logging capability. A larger battery can be used to get much longer logging times.

To make the electronics box for the collar, I cut down a Tic Tac container to fit, and cut a small slot in it to let the cat collar slide through. This lets the GPS module sit on the back of Conley's neck during

his adventures strolling around and provides the best GPS antenna reception.

The software used to program the system is very simple: An Arduino sketch runs on the TinyDuino, which captures the raw data from the GPS module and writes it to a text file on the microSD card. Pop out the microSD, put it in your computer, and you can open up the file in a program like Google Earth and see exactly where your cat was during the day, complete with timestamps. 📍

For complete step-by-step instructions, parts list, schematic, code, and photos, go to [makezine.com/gps-cat-tracker](http://makezine.com/gps-cat-tracker)

Share it: [#gpscattracker](https://twitter.com/gpscattracker)

## More Entertaining Pet Projects [makezine.com/projects](http://makezine.com/projects)



### Kitty Twitty Cat Toy

Make a cheery cat toy that sends tweets.



### Cat Scratch Feeder

Build a scratching post that dispenses treats.



### Fetch-O-Matic

Craft your own automatic tennis ball launcher for dogs.



# CNC Air Raid Siren



It's loud, annoying, and fun. Cut the parts on a CNC router, then motorize them with a cheapo bench grinder! *Written by Dan Spangler*

## Time Required:

**A Weekend**

## Cost:

**\$60-\$75**

## DAN SPANGLER

is the fabricator for MAKE Labs and our resident retro technology connoisseur.

Learn more about CNC:

## +SKILL BUILDER

CNC PANEL JOINERY

[makezine.com/cnc-panel-joinery](http://makezine.com/cnc-panel-joinery)



Learn a bag of tricks to design and CNC cut clever joints in plywood, acrylic, and other sheet stock.

## AIR RAID SIRENS FASCINATE ME, ESPECIALLY THE ONES FROM WORLD WAR II.

The infamous wail indicated danger but also sounded the all-clear, inspiring both fear and relief. They're also just awesomely loud. Nowadays there are electronic sirens, but most civil-defense sirens are still the mechanical kind — basically blowers designed to make as much noise as possible.

I saw DIY sirens online and instantly thought of our ShopBot CNC router as an elegant solution — it could cut a perfectly balanced rotor every time. So I designed this siren for CNC cutters. Here's how I made it, and how you can too.

**1. Motor.** Fractional-horsepower AC motors cost \$100 or more — so I used the MAKE Labs' crummy bench grinder. Get one at Harbor Freight (\$45 brand new). It even looks like a WWII siren.

**2. Cutting.** I cut the plywood to 24"×18" to fit our ShopBot Desktop (Maker Shed item #DSSBDP, [makershed.com](http://makershed.com)). I fit all the parts for two rotor-stator assemblies on one sheet of ¼" ply and two sheets of ¾", and cutting went off without a hitch. Adjust them to fit the cutter of your choice.

**3. Assembly.** Building the rotors is a matter of glue, dowels, and gentle persuasion with a rubber mallet. Testing them was scary — would they hold together or explode catastrophically? — but they spooled up to full speed and blew a surprising amount of air with almost no vibration. Sweet!

Next I mounted the stators and adjusted them to eliminate any rubbing. It was finally time to see if this thing was going to work. As the motor picked up speed, a faint wail began to emanate from the device, which quickly got louder and louder. By the time the motor got up to full speed the siren sounded so real and loud I had half a mind to duck and cover under my desk — it works! 🎧

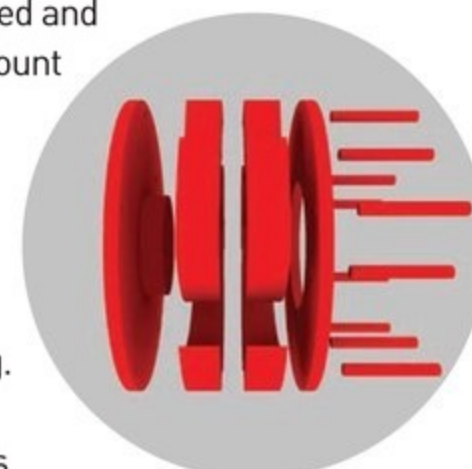

Hear it wail, download the CAD files for CNC cutting, and get step-by-step build instructions at [makezine.com/cnc-air-raid-siren](http://makezine.com/cnc-air-raid-siren).

Share it: [#cncairraidsiren](https://twitter.com/cncairraidsiren)



# Glow Plug 3D Printer Extruder

Make an extruder by hand using only a few tools and a diesel glow plug from the auto parts store.

Written and photographed by Adam Kemp

**Time Required:**  
**A Weekend**  
**Cost:**  
**\$40-\$60**

**ADAM KEMP**  
directs the Energy Systems Research Laboratory at Thomas Jefferson High School for Science and Technology in Alexandria, Va.



**I LOVE 3D PRINTING, SO I DECIDED TO BUILD MY OWN PRINTER.** I scavenged the stepper motors, linear rails, and drive belts, but I was stumped when it came to the extruder. The extruder designs I found online all had one flaw: They required 3D-printed parts. So you'd need a 3D printer to make a 3D printer!

My solution was to build this robust extruder using a handful of tools, one online parts order, and a trip to the auto parts store. It uses a \$10 glow plug from a diesel engine for a nozzle heater, and it performs very well.

## Hobbing a Bolt with a Drill Press

You'll need basic machining skills and tools to cut, drill, and tap aluminum bar stock and steel bolts, thread a steel rod, and bend a little sheet metal before you bolt it all together.

Typically an extruder's feed wheel is a hobbled bolt (i.e. a bolt with gear teeth cut into it) that's made using a lathe and a specialty jig. But if you don't have access to a lathe, there's a clever trick for hobbing a bolt with a drill press, a tap, and a couple of 608 skateboard bearings.

## Using a DIY Extruder

If you're swapping this into an existing printer, consider using the printer's thermocouple and stepper controller electronics. If you're building a new machine, connect the motor, stepper, and temperature sensor to the controller, and hook the glow plug to the heater circuit.

This extruder has a 0.3mm layer height, 1.75mm filament diameter, and 0.39mm nozzle diameter. To configure your software to use the new extruder, you'll need to calculate the rate at which plastic exits the nozzle (based on the feed wheel diameter, stepper resolution, and gear ratio). Plug this data into the Profile Maker over at [MakerBlock.com](http://MakerBlock.com) to automatically generate Skeinforge settings before you start printing. 🗨

Full instructions and photos at [makezine.com/glow-plug-3d-printer-extruder](http://makezine.com/glow-plug-3d-printer-extruder)

Share it: [#glowplug3dprinterextruder](https://twitter.com/glowplug3dprinterextruder)

## 3 Cool Things to 3D-Print!



### Animated MAKE Robot

by Zefram [thingiverse.com/thing:142215](http://thingiverse.com/thing:142215)

Mini-servos rotate the robot's head and arms. Download the Arduino sketch to make it dance.



### Balloon-Powered Helicopter

by Dr. Konrad Walus [thingiverse.com/thing:152804](http://thingiverse.com/thing:152804)

Print and assemble, then attach an inflated balloon and watch it fly.



### TARDIS Transformer V2

by Andrew Lindsey [thingiverse.com/thing:113117](http://thingiverse.com/thing:113117)

Time Lords, transform! Assembled using snap-on pieces to take on evil foes.



# MAKE A RIPCORD ROTOR CHOPPER

## MATERIALS:

- SPONGE EMERY BOARD
- WOODEN DOWEL, 3/8" DIAMETER, 7" LENGTH
- KITE STRING, 3'
- PVC PIPE, 1/2" DIAMETER, 6" LENGTH
- GLUE

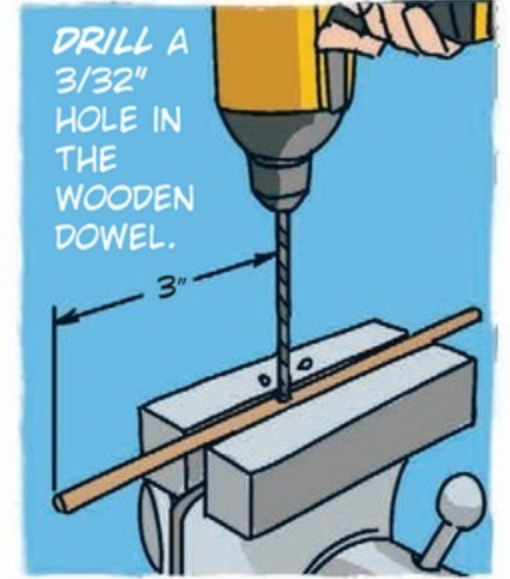

CUT A HOLE THROUGH THE EMERY BOARD AND GLUE THE WOODEN DOWEL TO THE BOARD.

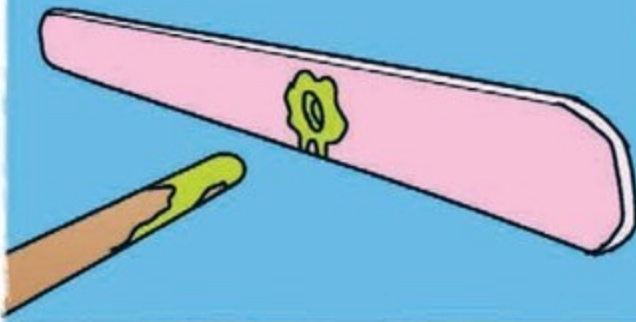

LET THE GLUE DRY. TWIST THE EMERY BOARD TO GIVE THE ROTOR LIFT.

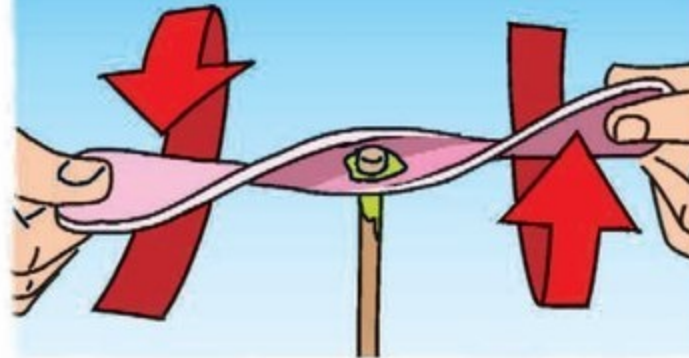

THREAD THE STRING THROUGH THE PVC PIPE AND WOODEN DOWEL LIKE SO.

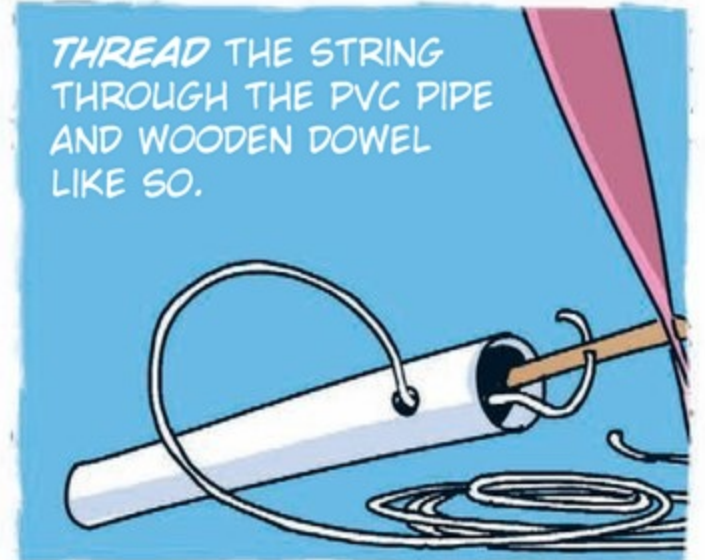

SPIN THE ROTOR COUNTER-CLOCKWISE TO WIND THE STRING AROUND THE DOWEL.



GRIP IT...  
AND RIP IT.



GIVE IT  
A  
WHIRL!





## T3 Innovation Snap Shot Spread Spectrum TDR SS200

\$246 : [t3innovation.com](http://t3innovation.com)

When a project grows beyond the workbench, difficult wiring problems may arise. If the cable is very long, hidden, or buried, troubleshooting becomes onerous and time consuming. Instead of using an ohmmeter and potentially cutting into the cable at regular intervals, the T3 Innovation Snap Shot TDR (Time Domain Reflectometer) peers inside the cable for you and measures the distance to a fault. Press the "test" button to display distance to a short or open circuit, or total cable length on the backlit LCD screen. Using spread spectrum technology, the Snap Shot tests powered lines up to 60 Volts, CAT5/6, telephone, coax, and speaker wire up to 3,000 feet while in use. Except for safety reasons where necessary, there's no need to disconnect the gear attached to the cables under test. The kit comes with adapters to connect F-type connectors, BNC, RJ-45, and alligator clips. Snap Shot can also broadcast a tone signal for use with an inductive wire tracer. —Mike Outmesguine

### TIPS TO SNAKE A REPLACEMENT CABLE

When changing a wire, tie a pull string to the faulty line to help feed in the replacement. Sometimes, however, you'll need to send the string through manually. It's often tricky to do, but these pointers can help.



Use a Shop-Vac to suck a cotton ball tied to fishing line through the conduit.



Drive an RC car across ceiling tiles with the string tied behind it.



Shoot a crossbow or airgun dart across a gap with a string tied to it (just like the movies!)



Throw a baseball sewn to fishing line over ceiling-mounted pipes or crossbeams.

James Burke





## Karma Controller

\$30 : [thinkgeek.com](http://thinkgeek.com)

The Karma Controller is an electronic controller kit for navigating through the internet discussion board Reddit. It's a PCB with 7 buttons and resistors, with pins to accommodate a Digispark (a tiny Arduino-compatible microcontroller that is included in the kit).

To the computer's eyes the controller is recognized as a mouse, and the buttons are set to move you from one story to the next, upvote and downvote, and scroll through comments. Intriguingly, the controller could be used for other purposes — all you have to do is reprogram the Arduino. The controller kit is an extremely easy soldering project, so if you're looking to get your feet wet this will do it. —John Baichtal

## True Temper 8-Pound Forged Steel Wood Chopper's Maul

[amestruetemper.com](http://amestruetemper.com)

Hatchets are irresistible. A nice old hatchet has all the tame-the-west romanticism of an ax in a charming little form factor. The only downside to hatchets is the harsh reality that they just don't work. Too puny, too light.

Always intimidated by wood splitting, I was certain that a perfect wood pile was the domain of Paul Bunyan-types with burly physiques built from a lifetime of Salisbury steak frozen dinners. Eventually, the aesthetics of wood chopping — a maul, a hardy stump, leather gloves, and head-to-toe flannel — proved too compelling to ignore and I bought the cheapest, 8lb maul from Lowe's.

It proved to be absolutely devastating to wood. One of the most satisfying purchases ever. The only strength required is the ability to swing it overhead, then momentum and gravity do the work as you guide the head to the log. When it connects, it is explosive. A nice, dry log just blows apart. Practice in the backyard, then split logs where the neighbors can see you. They will stop hassling you about your barking dog.

Hatchets still have their place — under the pillow for zombie apocalypse scenarios. —Mister Jalopy

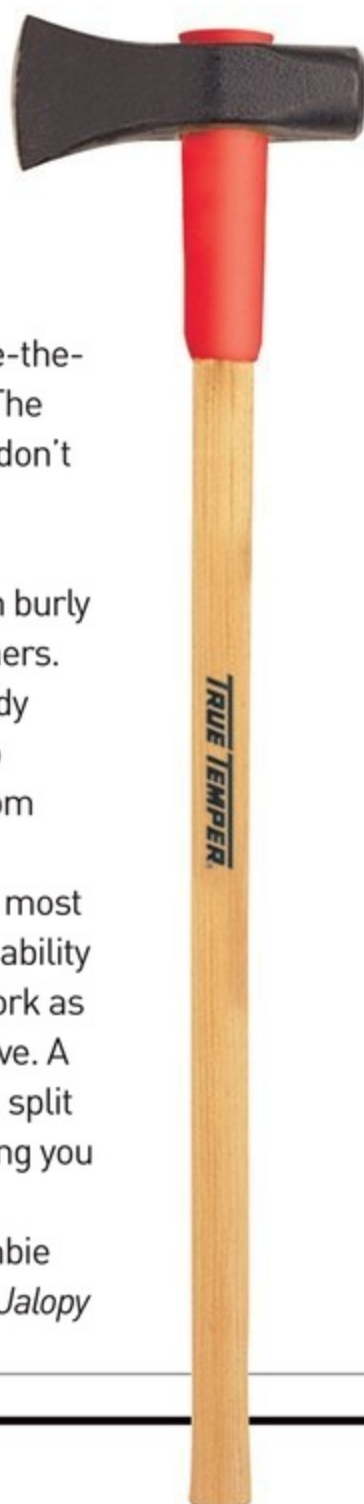

## Angel-5 Pencil Sharpener

\$25 : [carl-officeproducts.com](http://carl-officeproducts.com)

The Angel-5 resembles an old-fashioned wall pencil sharpener from any classroom but is not wall-mountable. How can an unmounted classic crank pencil sharpener be used with only two hands? (I don't have one hand to hold/anchor the unit, another to turn the crank, and a third hand to push the pencil in!)

The answer is in its unique feature: The sharpener, after being extended, grabs your pencil, maintains good pressure, and self-feeds it into the sharpener. You let go of your pencil and use one hand to hold the base while the other hand turns the crank. When the crank starts turning freely, your pencil is sharp as a tack.

These are made by Carl, whose name I recognized from high-end paper cutters. I purchased the basic one, available widely for \$25, even though I really want the \$45 one that lets you select from five different tip sharpnesses (I really prefer a blunter tip), but I wasn't ready to spend that much on a new technology. Now that I'm familiar with it, I'll look for an excuse to buy the preferred one, called the CC-2000. —Craig Wilson



Gunther Kirsch





Gunther Kirsch

## Cuttlebug

\$60 : [cuttlebug.ca](http://cuttlebug.ca)

The Cuttlebug is a nonelectronic die-cutting and embossing tool for paper crafts. It's lightweight, easy to use, and compatible with embossing folders and dies from most manufacturers. I am an avid paper crafter and scrapbooker, make all my own greeting cards, and use my 'bug more than any other tool.

YouTube shows lots of ways to use it for various techniques, including letterpress. I've had mine for about 10-12 years, use it at least weekly, and am still using the same cutting plates it came with. It's more intuitive to use and more compact when folded up than competing brands I've tried. Dies and embossing folders are available in any craft store, but you can also create your own embossing designs with leaves, lace, etc., using rubber mats made by the Spellbinders and Scor-Pal companies.

—Polly Robertus

## GoPro Hero3+ Black Edition

\$399 : [gopro.com](http://gopro.com)

Specwise, the Hero3+ is a nice little bump over the Hero3. What really stands out, though, is the size — it's 20% smaller than its predecessor. Video can now be shot at up to 4k resolution, and still can be shot at 12mp at 30 frames a second. What really shines is the new Super-View, a mode that shoots an immersive wide-angle video that captures more of the user and the surroundings. The camera kit also includes: a wi-fi remote (making helmet camera operation much easier than before), a battery, waterproof housing, and a variety of mounts for curved and flat surfaces.

—JS



Jake Spurlock

## Badland 12,000 Pound Winch

\$299 : [harborfreight.com](http://harborfreight.com)



The Badland 12,000 pound winch is a serious tool, and coming from Harbor Freight, its feature set comes at a fraction of the price of other competitive models. The 3/8" cable can tow in 12,000 pounds at a meager duty cycle of only 5%, (meaning that for every 45 seconds of full load towing, you will need to allow the winch around 15 minutes to cool), the winch will probably pull a car, tress, fence posts, or anything else that you need pulled quickly and effectively. For only \$29 you can add a wireless remote so that you can start pulls from inside a car. There are often Harbor Freight coupons for 10-25% off, making a purchase a little easier on the wallet.

—Jake Spurlock





## Velleman PS1503SBU DC Lab Power Supply

\$100 : [jameco.com](http://jameco.com)

The HQ Power PS1503SBU is a great addition to any hobbyist's or maker's bench. It has large easy-to-read digits for the voltage and current. The dials are smooth and easy to adjust to a specific value. The unit does not produce any excess heat or odd noises. The only downsides are: It does not ship with banana plugs and cables (you have to create your own); and it only has one positive and negative voltage terminal. This unit provides up to 15 volts, which is plenty for any microcontroller and most hobby/project circuits. It also provides 3 amps of current — ample for any small electronics project. The HQ comes in a compact portable case that makes it perfect for busy workspaces or ones with limited room. It provides clean power to noise-sensitive circuits and a steady reliable voltage that does not vary.

—Eloy Salinas



## HitCase Pro

\$130 : [hitcase.com](http://hitcase.com)

This is the ultimate “extreme sports” mounting system for an iPhone 5/5s. Use it to record your next longboarding expedition or dune buggy race. At its core the HitCase is a shock- and water-resistant case with a screen protector and mounting lug that allows you to plug the case into a variety of mounting devices, sold separately.

These GoPro-compatible mounts include a roll-bar attachment that tightens to the bar with the help of metal clamp bands, a handlebar mount, adhesive mount, as well as a chest-harness mount giving skiers and other nonvehicle daredevils a chance to record their stunts.

—JB



Gunther Kirsch

## Colored Hot Glue sticks

[glu-stix.com](http://glu-stix.com)

Hot glue is something everyone should have in their tool kit. Quickly build structures and secure parts or wires with it, and you can find glue sticks for various different materials from rubber, metal, and wood. Unlike other adhesives, you can undo hot glue: Just peel it off. Normally available only in translucent white, glue sticks for crafting are available in a rainbow of colors and are compatible with standard hot glue guns. Make custom-colored bumper feet for projects (like blue to match an Arduino board). Make matching repairs to frayed colored wires. Get the sample pack to try out a bunch of different colors. Or get bundles of a single favorite color. And if you're feeling really awesome, get the colored glitter sticks!

—Tod Kurt





## 8V Impact Screwdriver

\$40 : [blackanddecker.com](http://blackanddecker.com)

I used to think you couldn't beat a corded 1/2" drill for hardcore screwdriving, but I've just changed my mind. I recently built a wooden gate, driving a few dozen deck screws with my drill — careful, slow work. Then, I got my hands on the new Black & Decker 8V Max Lithium Impact Screwdriver. I can't believe how much better this compact, solid tool is for the job. Instead of risking stripped screw heads, it drives like a dream. The percussive rat-a-tat becomes a loud — but welcome — sound as it turns screws with terrific torque and speed. It comes with a charger, magnetic hex bit storage, and integrated LED light.

—John Edgar Park



## Kimwipes

[kcprofessional.com](http://kcprofessional.com)

Kimwipes look like tissue paper, but they're quite different. These low-lint wipes are used in labs throughout the country, but they're also great for makers. I use them mostly for cleaning 3D printer beds with acetone. Since they're also low-static, I use them with a horsehair brush and alcohol for cleaning PCBs. The wipes are also strong enough to scrub off adhesive gunk when using a solvent like Goo-Gone. Cheaper than lens wipes, they're great in a pinch for cleaning all kinds of optics, from microscope slides to magnifier lenses, and even your eyeglasses. They're not bad as LED diffusers, too.

—TK

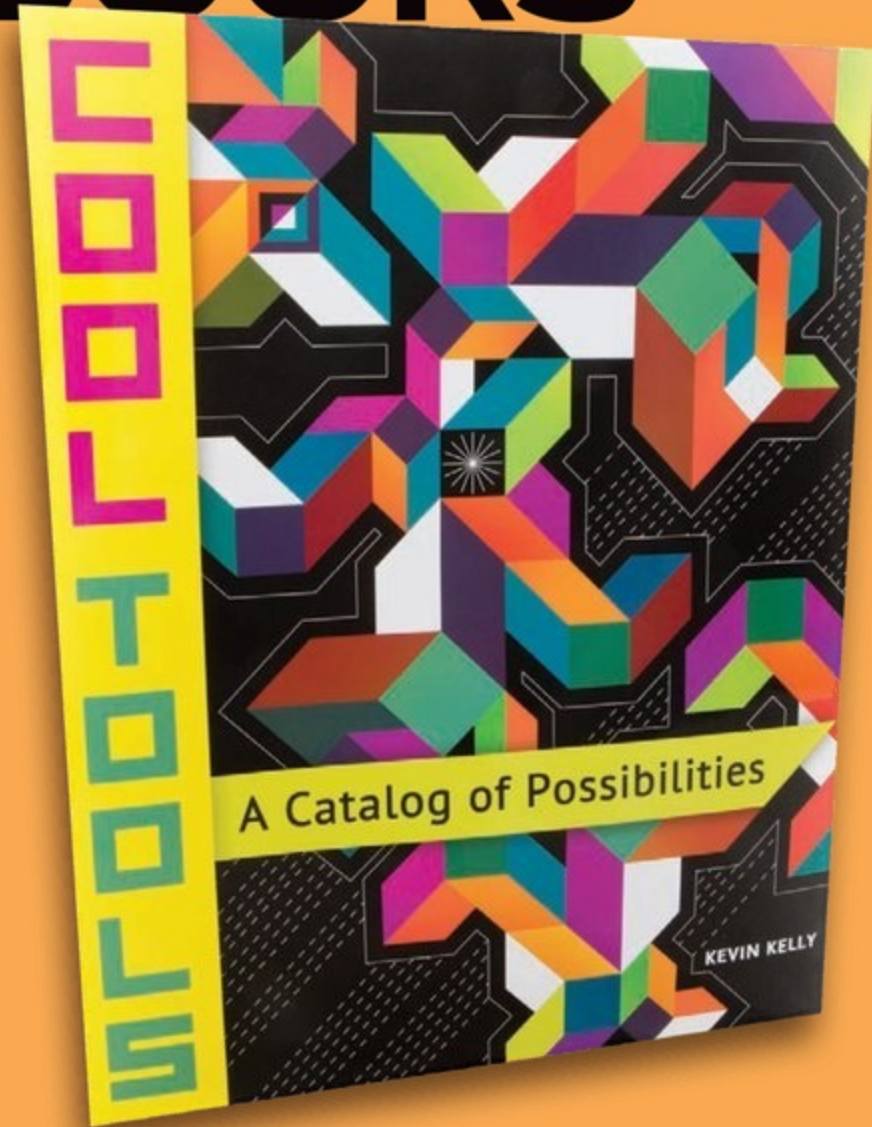

Photographs by Gunther Kirsch

## COOL TOOLS: A CATALOG OF POSSIBILITIES

by Kevin Kelly

\$24 : [Amazon.com](http://Amazon.com)

For more than 10 years, Kevin Kelly (a co-founder of Wired and an editor of the Whole Earth Catalog) has been publishing recommendations of useful tools on his website, Cool-Tools.org (disclosure — I recently started working with Kevin on the site). Using the Whole Earth Catalog as an inspiration, Kevin has collected more than 1,500 reviews from his website into a full-color, massively oversized, 472-page catalog of how-to information of immense interest to makers. Kevin's definition of a tool includes anything that helps you get something done — it could be a website, a book, a map, a material, an item of clothing, a gadget, or anything else that improves your abilities. If you wanted to rebuild civilization after a zombie apocalypse, this would be your guidebook.

The effect of seeing these reviews on large pages (when opened a two-page spread is 22"×17") is remarkable. As Kevin wrote on his site, "There is something very powerful at work on large pages of a book. Your brain begins to make naturally associations between tools in a way that it doesn't on small screens. The juxtapositions of diverse items on the page prod the reader to weave relationships between them, connecting ideas that once seemed far apart. The large real estate of the page opens up the mind, making you more receptive to patterns found in related tools. There's room to see the depth of a book in a glance. You can scan a whole field of one type of tool faster than you can on the web. In that respect, a large paper book rewards both fast browsing and deep study better than the web or a small tablet." As a result, Kevin has no plans for releasing an electronic version of the book (and the website is the electronic version, anyway).

When Kevin showed me a copy — airmailed from Hong Kong hot off the press — my mind was blown, just as it was when I discovered a copy of the Whole Earth Catalog when I was a 10-year-old. This is the book I want my kids to blow their minds with.

— Mark Frauenfelder





## NICK AND TESLA'S HIGH VOLTAGE DANGER LAB

by "Science Bob" Pflugfelder and Steve Hockensmith  
\$13 : Quirk Books

When the parents of 11-year-old twins Nick and Tesla disappear, they move in with their Uncle Newt. He's a gadget maker for a secret government agency. As you might expect, the kids quickly get involved in a hair-raising adventure, and are called on to build a number of electronic gadgets to save themselves and the free world from an untimely end. The bonus part of this fun middle-schooler adventure/mystery series is that the book includes instructions for building the devices Nick and Tesla use: a burglar alarm, an electromagnet, a mobile tracking device, a compressed-air water rocket, and more. It's the first in a series of books starring the techie twins. Look for the follow-up title, *Robot Army Rampage*, in February 2014.

—MF



## ARDUINO ADVENTURES: ESCAPE FROM GEMINI STATION

by James Floyd Kelly and Harold Timmis  
\$40 : Apress

Like Nick and Tesla's *High Voltage Danger Lab*, *Arduino Adventures* is a science-fiction novel filled with projects you can make to help the protagonists get out of dangerous situations. In this story, you and a couple of space cadets named Cade and Ella are trapped in a damaged space station that's orbiting Earth. Your mission is to build eight different Arduino gadgets that will enable you and the young scientists to escape the space station. Geared to a slightly older audience, even adults will have fun making a temperature sensor, a bucket transport system, a motion detecting gizmo, and more. The book was co-written by MAKE contributor James Floyd Kelly.

—MF



## STRUCTURAL PACKAGING: DESIGN YOUR OWN BOXES AND 3-D FORMS

by Paul Jackson  
\$25 : Laurence King

I recently listened to an interview with Mythbuster Adam Savage in which he enthusiastically described his ongoing love affair with cardboard as a construction material. Savage would find a soul mate in Paul Jackson, a papercraft artist and professional "folding consultant" to Nike, Siemens, and other companies. Jackson's book contains step-by-step instructions for making cardboard packaging and reflects his long experience and consideration of package design. Based on his formula for "creating the strongest possible one-piece net that will enclose any volumetric form which has flat faces and straight sides," the variety of box shapes shown here that can be made with a single sheet of cardboard is remarkable and inspiring. Take a look at videos and sample box templates: [www.laurenceking.com/en/structural-packaging-design-your-own-boxes-and-3d-forms/](http://www.laurenceking.com/en/structural-packaging-design-your-own-boxes-and-3d-forms/)

—MF



## RAW AND FINISHED MATERIALS

by Brian Dereu  
\$69 (ebook) \$85 (print) : Momentum Press

Written in a straightforward, easy-to-understand style, this is a guide to the properties and uses of common materials: metals, alloys, plastics, composites, ceramics, adhesives, and more. It's pricey, but a worthy addition to the bookshelf of anyone who builds things that must meet certain specifications achievable only through the use of certain materials. It's also full of interesting facts: "Teflon...is the only material that a gecko lizard cannot climb" and "Dried peat bogs...plagued Russia in 2010, where more than 30 peat fires joined several hundred forest fires in producing unprecedented deadly smog throughout the western half of the country." Brian Dereu, the author, has written two projects for MAKE: the "Dead Drop Device" (Vol 16, page 72) and the "Telekinetic Pen" magic trick (Vol 13, page 85).

—MF

# MAKING IT

MANUFACTURING TECHNIQUES FOR PRODUCT DESIGN  
2nd Edition  
Chris Lefteri

## MAKING IT: MANUFACTURING TECHNIQUES FOR PRODUCT DESIGN, 2ND EDITION

by Chris Lefteri  
\$35 : Laurence King

Have you ever looked at something and wondered, "How did they make that?" Chances are, this book will provide the answer. With descriptions of more than 100 different manufacturing techniques, including machining, CNC cutting, electron beam machining, plasma arc cutting, blow molding, fluid forming, and centrifugal casting, this book will make you envious of the production methods that are affordable only to deep-pocketed organizations, such as powder forging (aka sinter forging), which is used to make automotive parts and hand tools. However, many of the techniques are affordable even for small runs, and, at the very least, will open your eyes to what's possible. They may even inspire you to create a low-cost desktop manufacturing alternative to one of the expensive industrial processes described in the book.

—MF



# NEW MAKER TECH

## SENSE 3D SCANNER

\$399 : [cubify.com/sense](http://cubify.com/sense)

Version 2.0 of the 3D printing revolution is upon us, and the Sense 3D scanner is primed to lead the next wave in rapid manufacturing. Simply purchasing a 3D printer will only get you so far. The real challenge is modeling and scanning what you'd like to print. The Sense allows anyone, with a simple magic wand-like wave, to scan in color and print to almost any 3D printer. At \$399, it's also a bargain. You can read more about Sense 3D Scanner on the Cubify website. —*Marc de Vinck*



Gunther Kirsch



## STICKNFIND STICKERS

\$50 (2-pack) : [sticknfind.com](http://sticknfind.com)

These quarter-sized Bluetooth-enabled discs can be attached to pets, luggage, phones, key chains or other easily misplaced items. The StickNFind companion smartphone app can identify and locate any disc within 100 feet. If a disc is out of sight, you can remotely activate its buzzer and light. It also works as a virtual leash — if a sticker moves past a specified distance from your phone, your phone sounds an alert. —*MF*

## BLUEFRUIT EZ-KEY

\$20 : [adafruit.com](http://adafruit.com)

Any device that can take Bluetooth keyboard or mouse input will be at your command with Adafruit's new Bluefruit EZ-Key. The 12 digital input pins on the small board can be programmed to each send a specific key press, mouse movement, or mouse click wirelessly to a device. If you've dreamed of making your own wireless game controller or making technology more accessible for the disabled, the Bluefruit EZ-Key enables to you make custom wireless input devices without much hassle.

After pairing the Bluefruit EZ-Key with your computer, phone, or tablet, the board will send preprogrammed keypresses when you connect any of its input pins to ground. Just wire up any kind of momentary switch and it becomes wirelessly connected to your device. You can even use software to reprogram the pins to send different keypresses.

If you want to make a pedal that zaps spam from your inbox or physical controller for the game QWOP, the Bluefruit EZ-Key might be the solution for you. —*Matt Richardson*





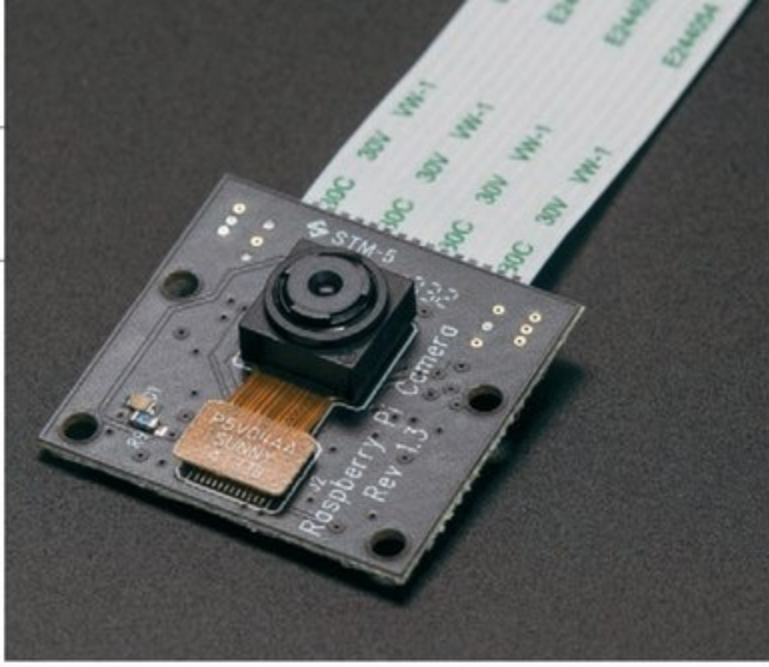

## PI NOIR INFRARED CAMERA

\$30 : [adafruit.com](http://adafruit.com)

The official camera board for Raspberry Pi is a popular accessory for the \$35 single board computer and it now comes in a new flavor. The Raspberry Pi Foundation released the Pi NoIR, which is the same camera board with the exception that the infrared cut filter is removed, allowing infrared light to hit the camera's sensor. This makes it a great accessory for projects involving night vision. Whether you're building a Pi-based security system or want to observe wildlife at night, the Pi NoIR camera is the perfect off-the-shelf component that connects to the camera serial interface on the Raspberry Pi.

The Pi NoIR camera board also includes an additional blue filter so that you can experiment with near-infrared photography, a method for assessing how well plants are photosynthesizing. This DIY science project turns the Pi NoIR camera board and a Raspberry Pi into an inexpensive instrument to help you examine plant health in your own backyard. —MR

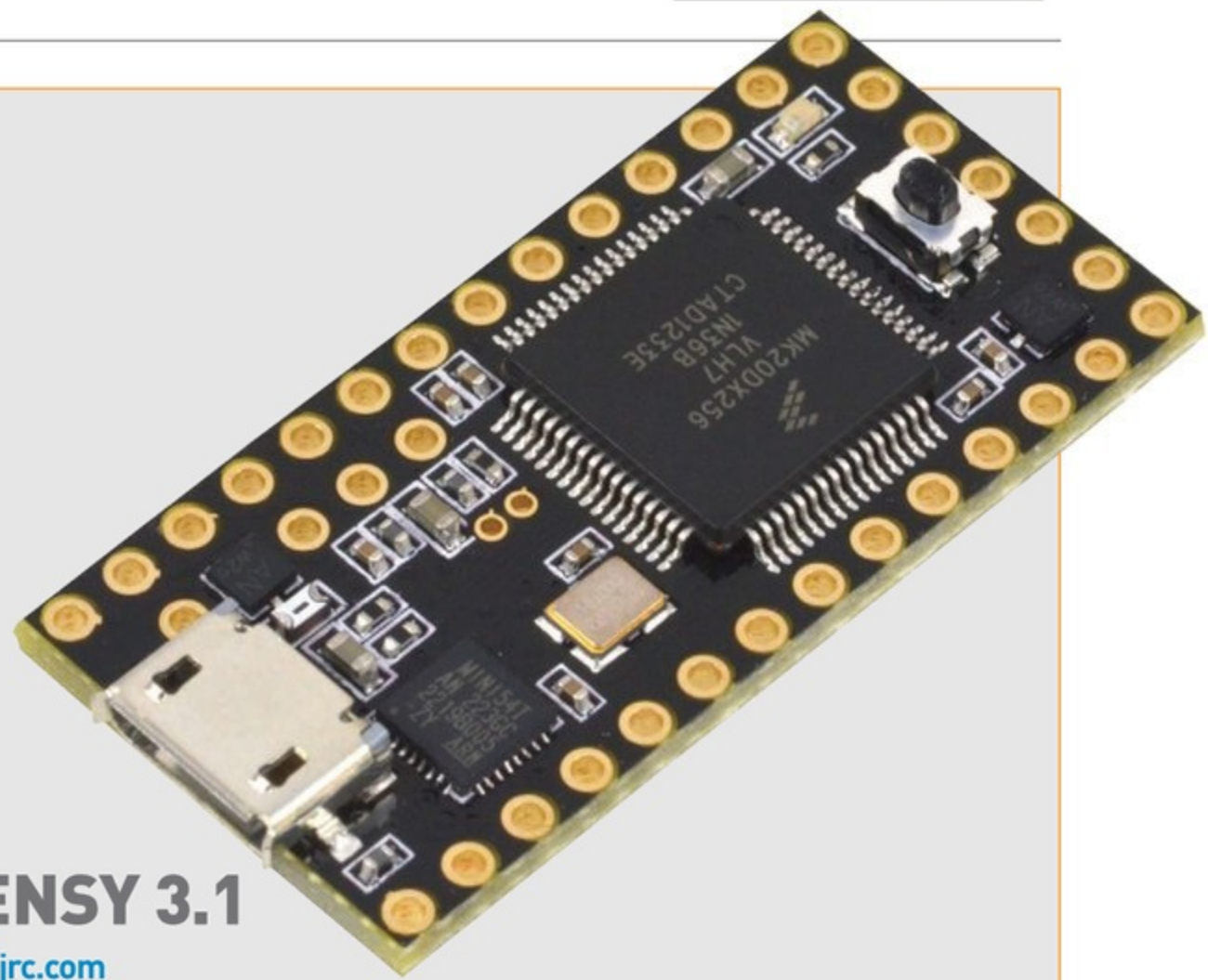

## TEENSY 3.1

\$20 : [pjrc.com](http://pjrc.com)

PJRC released another update to their popular Teensy USB line of small and inexpensive-yet-powerful microcontroller boards. The Teensy 3.1 has all the features of the powerful Teensy 3.0, but also quadruples the RAM, doubles the flash memory, has two analog to digital converters, and is capable of true analog output. All these new features (along with a few others) come in the same small size, and it costs only slightly more than the previous iteration of the board.

Like the Teensy 3.0, the new board sports a 32-bit ARM Cortex-M4 processor and can be programmed with AVR C or within the Arduino IDE along with the Teensyduino add-on. And with more direct memory access channels, you can now use the Teensy 3.1 to control 3,000 addressable LEDs at video refresh rates or even stream high-quality audio signals. That's a lot of power for such a teensy package! —MR



## LITTLEBITS SYNTH KIT

\$159 : [littlebits.cc/kits/synth-kit](http://littlebits.cc/kits/synth-kit)

littleBits, in collaboration with Korg, has created the Synth Kit, which enables anyone to build their own modular synthesizer with little to no engineering or musical knowledge. It's as simple as plug-and-play and you'll be off creating combos of audio, visual, and sensory experiences. The kit includes step-by-step instructions for creating 10 musical projects, including a keytar and Synth Spin Table. Check out the littleBits website to see what comedian/musician Reggie Watts and others are creating with this new little musical wonder. —MV



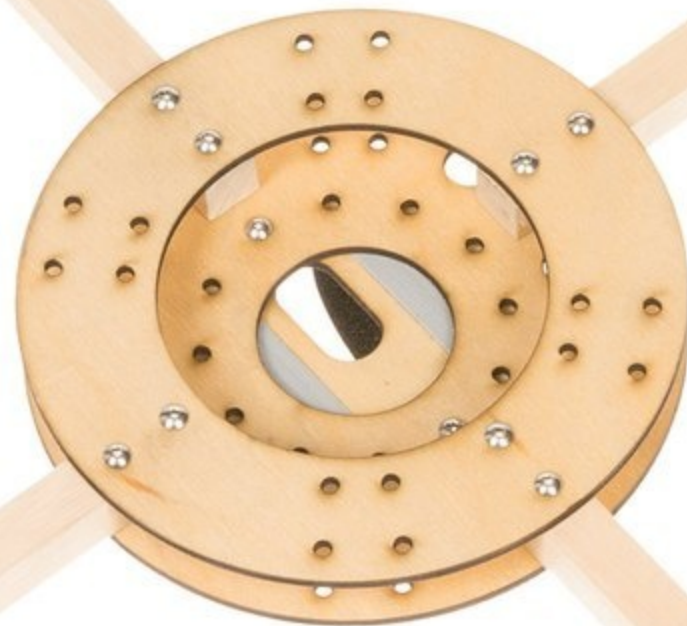

# NEW IN THE SHED

SOON TO BE DELIVERED BY DRONE...

Written by Eric Weinoffer, Product Development Engineer, Maker Shed

The “Drones and Flight” category in the Maker Shed is one I’m extremely excited about. There’s been a lot of neat progress in the technology that goes into multirotors during the last year or so, and there’s a lot of room for us to expand. This is just the beginning.

I’m especially excited to see how you, the MAKE audience, use these products in combination with others to create unique, exciting projects. Have you thought about attaching a microcontroller to your multirotor for data tracking and wireless transmission down to the ground? Or using EL wire to set up your multirotor for gorgeous, nighttime flight?

The skies are yours to explore — here are new products, drones and beyond, that we’re particularly pumped about.

## FLITETEST ANYCOPTER QUAD 370 KIT

The Flitetest Anycopter Quad 370 Kit is a fantastic first frame kit for the aspiring multirotor builder. It comes with hardware, four Delrin legs, and a laser-cut wooden frame that can accommodate multirotors of almost any configuration. The folks behind Flitetest have years of experience in all things remote-control flight and produce a great biweekly show on YouTube filled with challenges, reviews, and tutorials. (They’ve also created the DIY quadcopter project on page 44). I recently built a custom quad with this kit for myself, and couldn’t be happier with how easy it was to assemble and how it’s handled the inevitable crashes.

■ MKFT01 ■ \$59



## EZ-EL WIRE STARTER PACK

The quintessential accessory for burners and Tron cosplayers, electroluminescent (EL) wire is great for adding some light-up flare to your project. The EZ-EL Starter Pack comes in 10- and 25-foot packs with a AA battery inverter that can power up to 100 feet of wire. Available in red, sky blue, green, purple, orange, and white, EL wire is flexible and can be used out-of-the-box to trick out your bike, backpack, fancy new multicopter, or whatever you can attach it to. With a little soldering practice you can splice multiple wires to the inverter and make more intricate designs for costumes and art projects. You can tell people it’s for safety and visibility, sure, but it also looks awesome for everyday use.

■ MKEZL01 (10 feet) ■ \$20







## PCDUINO V2

The PCduino is the result of combining a microcontroller and a single-board Linux computer. At its heart is an ARM Cortex A8 processor, like the BeagleBone Black, which comes preloaded with Ubuntu, ready to run Linux out of the box. Unlike V1 of the board, which required a breakout board or jumper wires in order to connect to shields, this version of the board supports standard Arduino shields via female headers and is programmable via the Arduino IDE (also preloaded). Along with this flexibility comes ease-of-use: Installing Android is easily accomplished in under 10 minutes and the board has integrated wi-fi, so you don't have to dig around the house for that 10-foot Ethernet cable you put *somewhere*.

■ MKLK01 ■ \$66

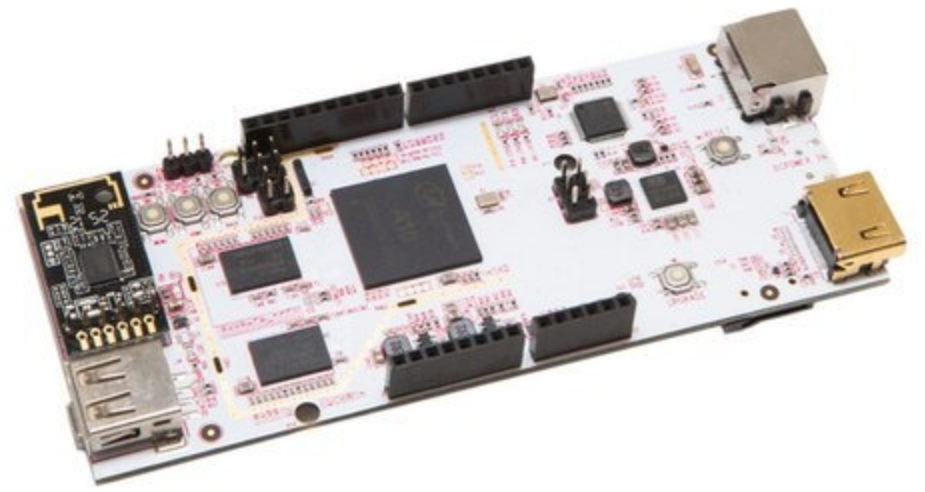

## 3D ROBOTICS QUADCOPTER KIT

The Quadcopter Kit from 3D Robotics is great for those who are looking to add some autonomy to their flying experience. The Arduino Pilot Mega board that comes with this kit can reliably stabilize any configuration of multirotor and is easy to set up. It's a flexible, powerful board that not only keeps your craft stable in the air, but can send it on a preplanned path (which you specify in the free software), command it to automatically land, or even follow you from the air. Geofencing, a robust airframe, and various failsafe features will keep your quad in sight, stable, and off the ground.

■ MK3DR01 ■ \$506



## WILDFIRE

Typically, connecting your Arduino project to the internet requires at least one shield and far more work than it should. Thankfully, Wicked Device has a single-board solution, the WildFire. This Arduino-compatible microcontroller comes with the TI CC3000 wi-fi module and a ceramic antenna built in. A free mobile app from TI makes it possible to connect your WildFire to your phone right out of the box, and the ATmega1284p processor has a hefty-sized memory, making it easier to build connected devices with greater data requirements.

■ MKWD11 ■ \$90

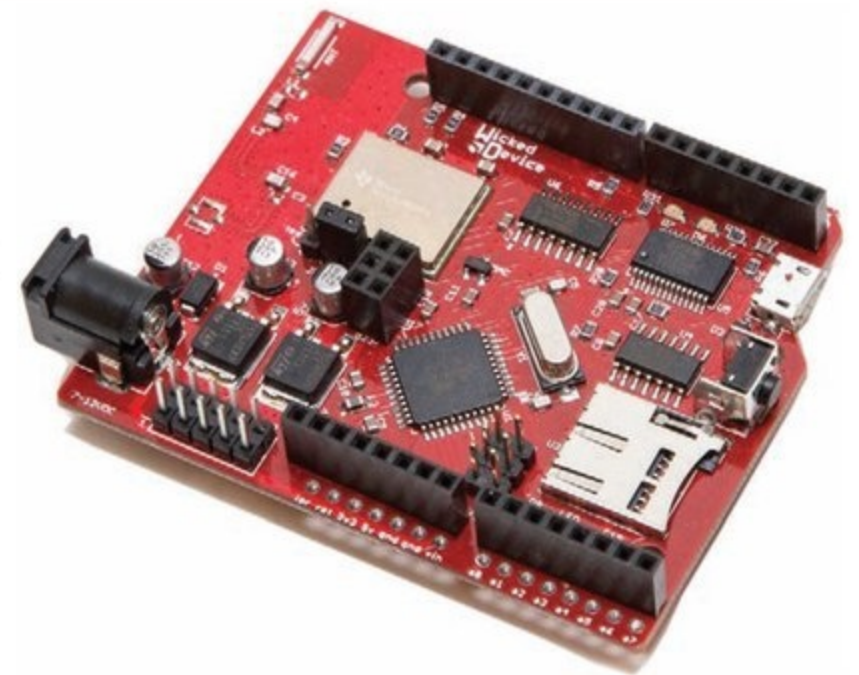

## BEER MAKING KITS FROM BROOKLYN BREW SHOP

If your passion is craft brewing, you're in luck! The Shed carries a slew of products that will kickstart a hobby in beer making. We have Bruxelles Blonde, Chestnut Brown Ale, and Everyday IPA (for folks who like a little extra hoppiness in their brews). Each kit contains all the supplies needed for the fermentation of one gallon of delicious beer. Though the supplies for bottling are not included in the kit, Brooklyn Brew offers a supplemental pack that contains a bottle capper and 50 bottle caps. Start saving your (sterilized!) beer bottles, and you'll be brewing your own beer in no time.

■ MKBBS6 (Bruxelles Blonde) ■ \$40

■ MKBBS7 (Chestnut Brown Ale) ■ \$40

■ MKBBS1 (Everyday IPA) ■ \$40







**ESUN 易生**  
Professional 3D-Printing-Material Solution Supplier

SGS UKAS ISO 9001

Red	Yellow	Green	Blue
Black	White	Orange	Light Blue
Grey	Yellow	Pink	White
Green	Black	Orange	Purple

- PLA filament
- ABS filament
- PVA filament
- HIPS filament
- PC filament
- Flexible filament
- Wood filament
- Nylon filament
- Conductive filament

Accepts customized requirements for 3D printer manufacturers and filament resellers

[www.esunchina.net](http://www.esunchina.net)  
[bright@brighten.net](mailto:bright@brighten.net)

## PLASTIC INJECTION MOLDING MACHINES - STARTING AT \$595!

Mold your own plastic parts. Perfect for inventors, schools or companies. Full details & videos on our webpage.



The affordable Model 20A turns your workshop drill press into an efficient plastic injection molding machine. Simple to operate and it includes a digital temperature controller.

No expensive tooling is required - use aluminum or epoxy molds.

The bench Model 150A features a larger shot capacity and is perfect for prototyping or short production runs. Capable of producing up to 180 parts per hour!



**MADE IN THE USA**

We also carry:

- MOLDS
- CLAMPS
- ACCESSORIES
- PLASTIC PELLETS



PayPal  
VISA MasterCard American Express Discover BANK

[www.easyplasticmolding.com](http://www.easyplasticmolding.com)

## WORLD'S MOST VERSATILE CIRCUIT BOARD HOLDERS



Model 324 Our Circuit Board Holders add versatility & precision to your DIY electronics project. Solder, assemble & organize with ease.



Model 201

VISIT US ON  

**MONTHLY CONTEST**  
Visit us on Facebook® to post a photo of your creative PanaVise project for a chance to win a PanaVise prize package.

**PANAVISE®**  
Innovative Holding Solutions

7540 Colbert Drive • Reno • Nevada 89511 | (800) 759-7535 | [www.PanaVise.com](http://www.PanaVise.com)

## 3D printing isn't magic, but LEO the Maker Prince is.



**LEO the maker prince**  
JOURNEYS IN 3D PRINTING  
by Carla Diana

Gunther Kirsch

Author Carla Diana's fanciful, fully illustrated book is for anyone interested in 3D printing, young and old alike. Each object featured in the book can be downloaded for free so that you can print them yourself!

**Make:**  
[makershed.com/leo](http://makershed.com/leo)



# PARTS EXPRESS

YOUR ELECTRONICS CONNECTION™

## OVER 15,000 ELECTRONIC PARTS IN STOCK

<b>Speakers</b>	<b>Project Accessories</b>
	
<b>Components</b>	<b>Tools/Tech Aids</b>
	





Call or visit us online today to receive your **FREE** copy of our 2013 catalog!

**parts-express.com/make**  
1-800-338-0531



# MPJA ONLINE

Free Color Catalog

Offering a Full Line of Electronic Parts to the Maker Community for over 30 years.

- Discounted Prices
- Fast Service
- Unique Items











**Marlin P. Jones & Assoc. Inc.**  
**www.mpja.com/make1**

Visit our **MAKE** only Special Promotions page. **1-800-652-6733**

# pcDuino

[www.pcdduino.com](http://www.pcdduino.com)      [www.linksprite.com](http://www.linksprite.com)

pcDuino is a mini PC that runs Ubuntu/Android. It has Arduino headers so that existing Arduino Shields can be used with pcDuino. It is a platform that bridges the open software community and open hardware community.



### Specification

- CPU: 1GHZ ARM Cortex A8
- GPU: OpenGL ES2.0, OpenVG 1.1 Mali 400 core
- DRAM: 1GB
- Flash: 2GB, with SD card supports up to 32GB
- HDMI 1080p video output
- OS: Ubuntu and Android
- Hardware: Arduino interface
- Network: Built-in WiFi and Ethernet

### What pcDuino can do?

With pcDuino, users can:

- Learn or teach programming
- Learn hardware interface
- Learn Linux/Ubuntu and Android
- Support media center
- Build DIY software/hardware project
- Facilitate children's education

pcDuino wechat account



pcDuino website



LinkSprite Learning Center



## THINK BIG, PRINT HUGE.



re3D

2FT X 2FT X 2FT BUILD VOLUME - ORDER TODAY!

# GIGABOT™

your personal factory, delivered.

[www.re3D.org](http://www.re3D.org)  
[sales@re3D.org](mailto:sales@re3D.org)





# My Own Pinball Machine

Written by Tom Kuehn

Kelly Short



**TOM KUEHN**

is a mechatronic engineer from Newcastle, Australia. He loves tinkering with electronics, mechanics and everything in between.

**PINBALL MACHINES HAVE ALWAYS FASCINATED ME,** and after studying engineering for two years in 2005, I felt I knew enough to build one from scratch. After all, how hard could it be?

Seven years later, I finally have a finished machine to show for all my hard work. The player takes the role of an archetypal James Bond villain; the scoreboard tallies the player's percentage of world domination.

I started out with a blank sheet of plywood and began sketching the layout of the main parts, such as flippers, pop-bumpers, slingshots, ramps, and drop targets. With the help of some pinball simulation software, I was able to playtest my designs before even picking up a tool. Once I was sure about the layout, the fun started, as I cut, drilled, and routed my playfield to accommodate the parts. I built many of them myself, including target arrays, plastic ramps, wire frames, and ball guides.

I then built a cabinet to house the playfield, using a recycled shower screen for the glass top. With the help of an artist friend, I painted cartoon artwork on the playfield and sealed it in with a clear coat. I also built an LED backlit scoreboard using 7-segment displays and artwork printed on translucent film.

For the brains of the machine, I designed a custom circuit board with an ATmega32 and some interface chips, allowing me to individually control 256 LEDs and accept 64 switch inputs. I added two sound modules to play sound effects and music from SD cards. Finally, after lots of programming, testing, and debugging, my machine came to life!

After playtesting the machine for a while now, it seems I made things too difficult. The high score is a measly 18%, but taking over the world was never going to be easy... 🎯

+ See more photos: [worlddominationpinball.wordpress.com](http://worlddominationpinball.wordpress.com)



# The new essential tool for every maker.

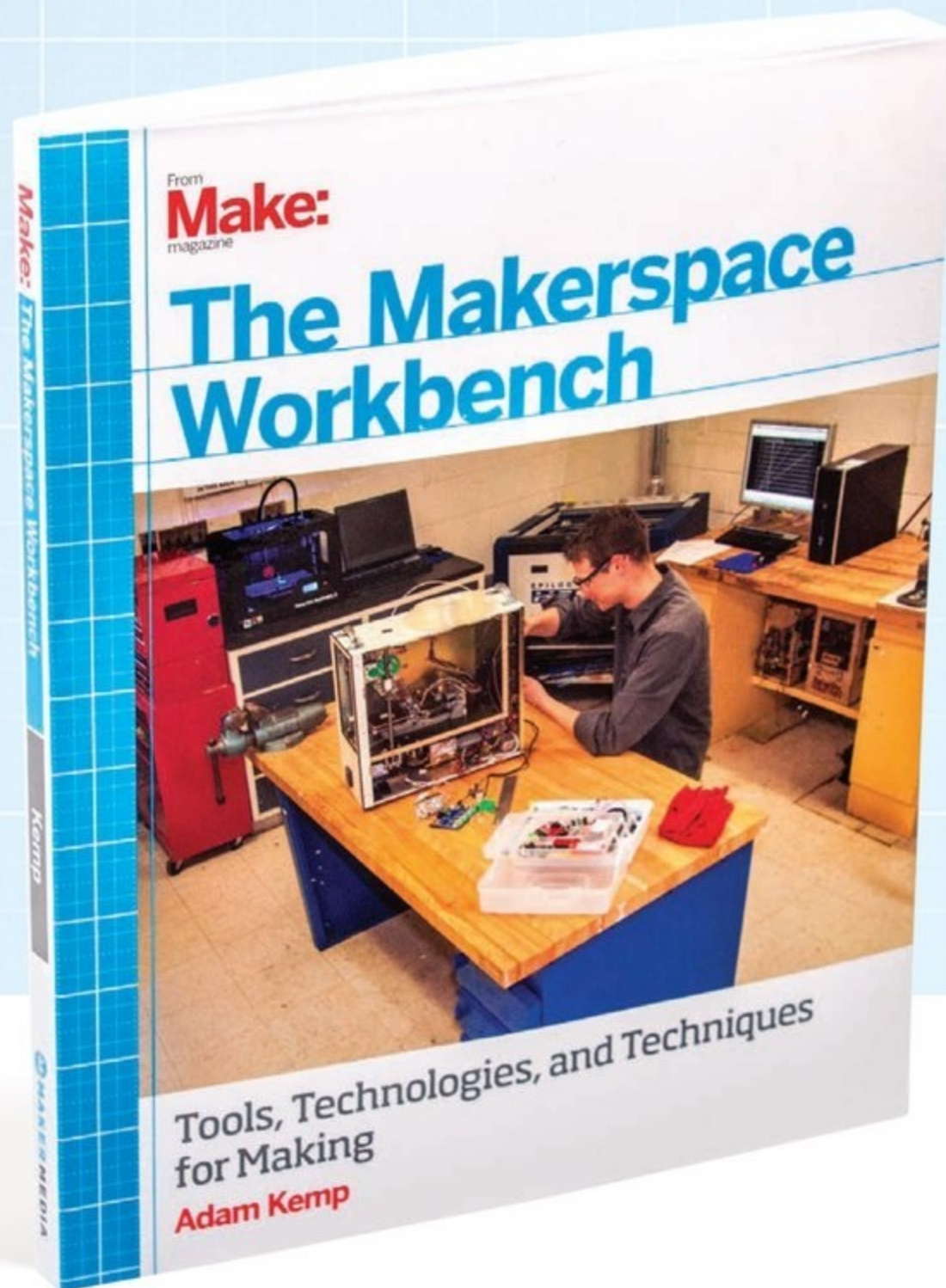

## Learn how to:

- Fabricate PC boards
- Use a laser cutter and 3D printer
- Make molds
- Work with glass
- Much more!

From scotch tape to lasers, find out the tools you need to outfit your perfect makerspace.

# Make:

[makershed.com/workbench](http://makershed.com/workbench)



# Join the electronic design revolution

- Tired of desoldering your mistakes?
- Squinting at resistors only to lose them?
- Taking your project apart over and over until you get it just right?

- With the 123D Circuits web app you can breadboard and simulate your circuits, and write, compile and run code right in your browser.  
When you're done you can have the circuit board professionally made and shipped to your door!

Why wait? Get started now. [www.123Dapp.com/circuits](http://www.123Dapp.com/circuits)



AUTODESK®  
123D® CIRCUITS

Autodesk, the Autodesk logo, and Autodesk® 123D® are registered trademarks or trademarks of Autodesk, Inc., and/or its subsidiaries and/or affiliates in the USA and/or other countries. All other brand names, product names, or trademarks belong to their respective holders. Autodesk reserves the right to alter product and services offerings, and specifications and pricing at any time without notice, and is not responsible for typographical or graphical errors that may appear in this document. © 2014 Autodesk, Inc. All rights reserved.

 AUTODESK.