

THE MANGA GUIDE™ TO

COMICS
INSIDE!

ELECTRICITY

KAZUHIRO FUJITAKI
MATSUDA
TREND-PRO CO., LTD.



THE MANGA GUIDE™ TO

ELECTRICITY

KAZUHIRO FUJITAKI
MATSUDA
TREND-PRO CO., LTD.



CONTENTS

| | |
|--|----|
| PREFACE | xi |
| PROLOGUE | |
| FROM ELECTOPIA, THE LAND OF ELECTRICITY | 1 |
| | |
| 1 | |
| WHAT IS ELECTRICITY? | 13 |
| Electricity and Everyday Life..... | 14 |
| Electrical Units..... | 15 |
| Electricity in the Home..... | 19 |
| How Electricity Works..... | 25 |
| The True Nature of Electricity..... | 26 |
| Current and Electrical Discharge..... | 30 |
| Atomic Structure and Conductivity..... | 34 |
| Static Electricity..... | 36 |
| The Triboelectric Series..... | 40 |
| Uses of Static Electricity..... | 43 |
| Tags on Consumer Electric Products..... | 45 |
| Voltage and Potential..... | 46 |
| Atoms and Electrons..... | 47 |
| Static Electricity..... | 49 |
| Electrostatic Force..... | 49 |
| The Triboelectric Series..... | 51 |
| Movement of Charge and Direction of Current..... | 51 |
| | |
| 2 | |
| WHAT ARE ELECTRIC CIRCUITS? | 55 |
| Electric Circuits in Everyday Devices..... | 56 |
| A Flashlight's Circuit..... | 59 |
| Parts of an Electric Circuit..... | 61 |
| Ohm's Law and Methods of Connecting Electrical Components..... | 67 |
| Electric Circuits and Ohm's Law..... | 68 |
| Series and Parallel Connections..... | 69 |
| Electric Circuits and Current..... | 73 |
| Graphical Symbols..... | 73 |
| Direct Current Circuit and Alternating Current Circuit..... | 74 |
| Ohm's Law..... | 76 |
| Resistivity and Conductivity..... | 77 |
| Effective Resistance..... | 78 |

3

| | |
|---|-----|
| HOW DOES ELECTRICITY WORK? | 81 |
| Why Does Electricity Produce Heat? | 82 |
| Electricity and Joule Heat | 85 |
| How Is Heat Generated by Current? | 87 |
| Thermal Emission and Luminescence | 90 |
| Current and Magnetic Fields | 94 |
| Fleming's Left-Hand Rule (For DC Motors) | 98 |
| Fleming's Right-Hand Rule (For Generators) | 100 |
| Joule Heat | 104 |
| Thermal Vibration | 104 |
| Electromagnetic Waves | 106 |
| Electricity and Magnetism | 107 |
| Fleming's Left-Hand Rule and Motors | 109 |
| Fleming's Right-Hand Rule and Electric Generators | 110 |
| Electricity and Coils | 111 |
| Coils and Electromagnetic Induction | 111 |
| Coils and Inductance | 112 |
| Coils and Alternating Current | 113 |
| Coils and Transformers | 114 |
| Capacitors | 115 |
| Capacitors and Alternating Current | 115 |

4

| | |
|--|-----|
| HOW DO YOU CREATE ELECTRICITY? | 117 |
| Generators | 118 |
| How Does a Power Generator Create Electricity? | 121 |
| Batteries and Other Sources of Electricity | 124 |
| Chemical Cells | 126 |
| What Happens in a Dry Cell Battery? | 132 |
| Water and Fuel Cells | 135 |
| Anodes and Cathodes | 138 |
| Creating Your Own Coin Battery | 140 |
| Thermopiles | 141 |
| Electricity Created by a Power Plant | 147 |
| Thermal Power Generation | 149 |
| Nuclear Power Generation | 151 |
| Hydroelectric Power Generation | 152 |
| Wind Power Generation | 154 |

| | |
|--|-----|
| 5 | |
| HOW CAN YOU CONVENIENTLY USE ELECTRICITY? | 155 |
| What are Semiconductors? | 161 |
| Diodes and Transistors | 169 |
| Diodes That Emit Light | 174 |
| Transistors | 176 |
| Diodes | 186 |
| Transistors | 188 |
| Field-Effect Transistor | 188 |
| Converters and Inverters | 189 |
| Sensors | 190 |
| Temperature Sensors | 190 |
| Optical Sensors | 192 |
| EPILOGUE | 197 |
| INDEX | 201 |

PREFACE

Our current lifestyle necessitates the use of electricity. Electric current is often explained by comparing it to flowing water, but since electricity cannot be seen by the naked eye, this metaphor can be difficult to understand. What can we do to better understand electricity?

Electricity is very helpful in almost every facet of our lives; it produces light, heat, and power. Even though we can see these benefits, we are usually unaware of electricity itself. However, if we simply learn the basics, we can get a clear picture of how electricity works.

This book explains fundamental electrical concepts using a story told through manga followed by further explanations in written text. There are no complicated explanations—readers simply listen along with the heroine Rereko as her teacher Hikaru explains concepts. Even people who have had a hard time understanding electricity will find Hikaru's explanations easy to comprehend.

I am extremely grateful to Matsuda, who provided the artwork, and to everyone at TREND-PRO, who produced the book. I would also like to give my sincere thanks to Professor Masaaki Mitani for checking my work. I am also very thankful to Ohmsha, Ltd. for giving me the opportunity to write this book.

I hope that in reading this book you will learn about electricity and gain a familiarity with it.

KAZUHIRO FUJITAKI
DECEMBER 2006

PROLOGUE:
FROM ELECTOPIA,
THE LAND OF ELECTRICITY



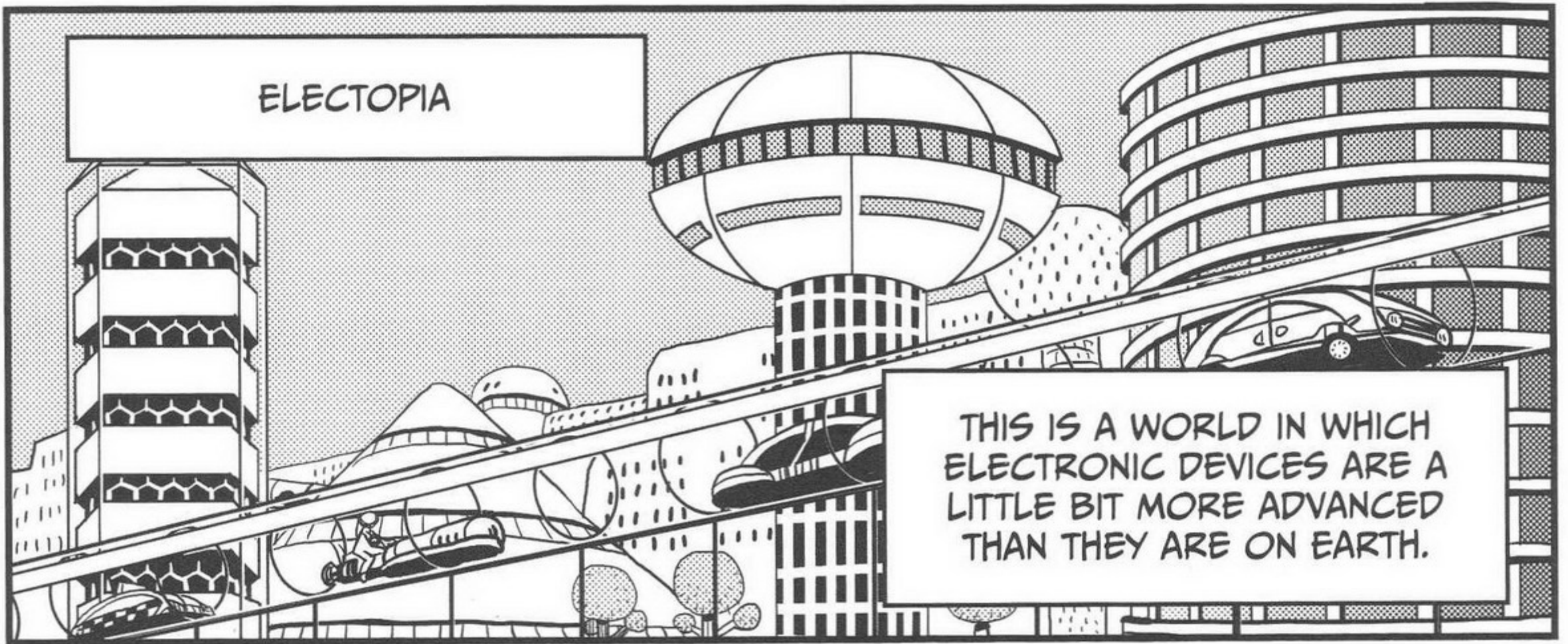

ELECTOPIA

THIS IS A WORLD IN WHICH ELECTRONIC DEVICES ARE A LITTLE BIT MORE ADVANCED THAN THEY ARE ON EARTH.



HOWEVER, STUDENTS ON ELECTOPIA HAVE THE SAME KINDS OF PROBLEMS THAT STUDENTS ON EARTH DO.

中央電子教育学校

*CENTRAL ELECTRICAL TRAINING SCHOOL



REREKO...

中等部 職員室

* HIGH SCHOOL TEACHER'S ROOM

DO YOU KNOW WHY I CALLED YOU IN?

UH...UM...



WELL, I'VE NEVER BEEN VERY SMART... BUT I HONESTLY DON'T KNOW.

THAT'S OKAY. YOU ALMOST HAVE THE RIGHT ANSWER.

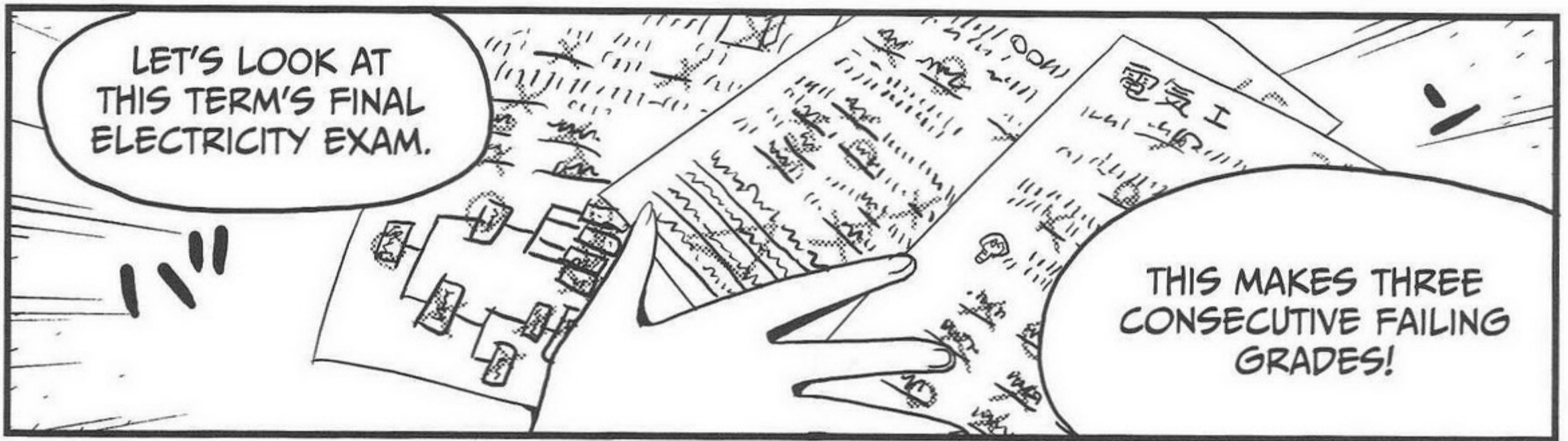

LET'S LOOK AT THIS TERM'S FINAL ELECTRICITY EXAM.

THIS MAKES THREE CONSECUTIVE FAILING GRADES!



BUT I'M DOING SO WELL IN MY OTHER CLASSES!

I'M IMPRESSED WITH YOUR POSITIVE ATTITUDE.



NEVERTHELESS, YOU'RE GOING TO HAVE TO GIVE UP YOUR SUMMER VACATION TO TAKE SOME EXTRA CLASSES.

WHA...?



DID YOU SAY GIVE UP SUMMER VACATION!?

THAT'S RIGHT! YOU'LL GO TO STUDY ON EARTH AND START WITH THE FUNDAMENTALS!



HARUMPH.

DON'T WORRY. IT'S NOT SO DIFFERENT THERE. AND SINCE THE STUDY OF ELECTRICITY IS SLOWER, IT'LL BE PERFECT FOR YOU!

B...B...BUT...IF I SUDDENLY SHOW UP, IT'LL PROBABLY BE INCONVENIENT FOR THE TEACHER THERE.

B...B...BUT, BUT...MY PARENTS HAVEN'T GIVEN PERMISSION FOR ME TO GO YET, RIGHT?

I ALREADY SENT A LETTER, SO IT'LL BE FINE.

THEY SAID, "GO FOR IT!"

YOU! A SMART WOMAN LIKE YOU NEVER MAKES A MISTAKE, DO YOU?

WHAT IS IT?
A ROBOT?

IT'S YONOSUKE, A TRANSDIMENSIONAL WALKIE-TALKIE AND OBSERVATION ROBOT!

TAKE THIS WITH YOU FOR LATER.

TAKE GOOD CARE OF HIM! YOU'LL ALSO USE HIM INSTEAD OF A PASSPORT WHEN GOING BACK AND FORTH TO EARTH.

NICE TO MEET YOU.

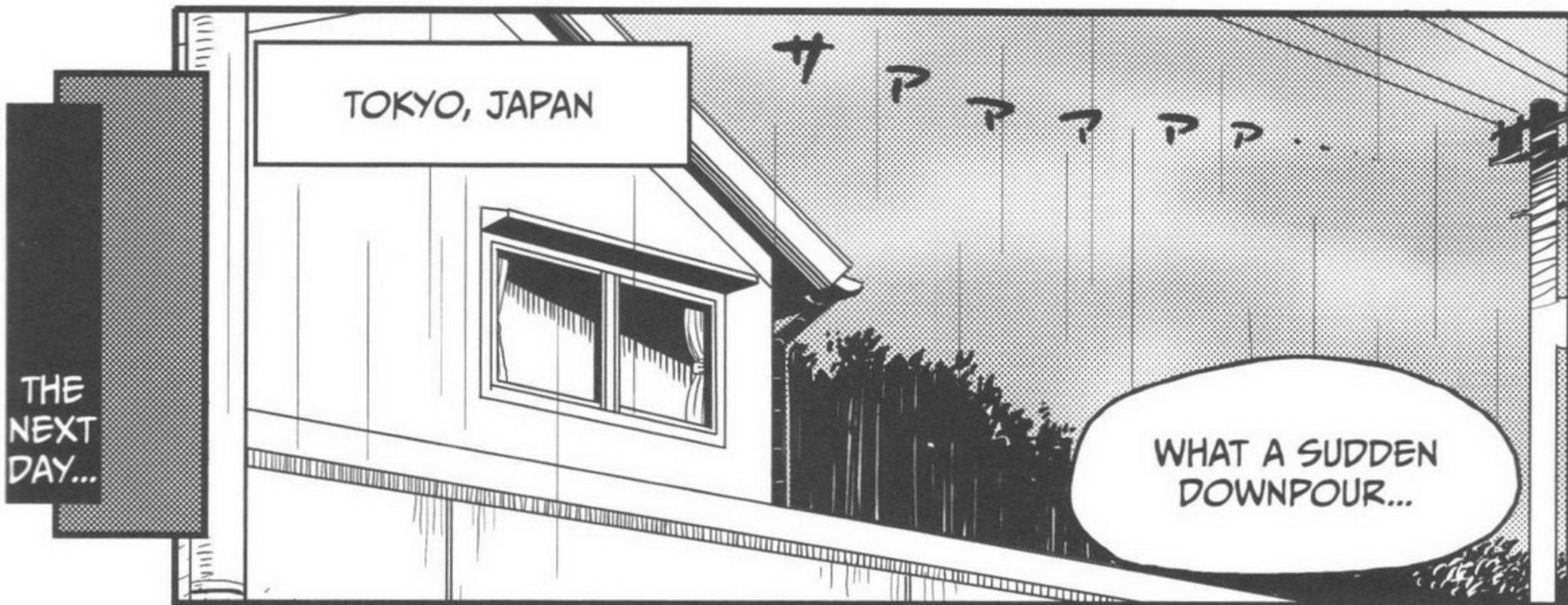

THE NEXT DAY...

TOKYO, JAPAN

WHAT A SUDDEN DOWNPOUR...



I'M GOING TO GET SOAKED!
I WISH I'D BROUGHT AN UMBRELLA.



I'M ALMOST HOME...I GUESS I'LL JUST RUN...

CRACK!



⇒GULP⇒

UH...

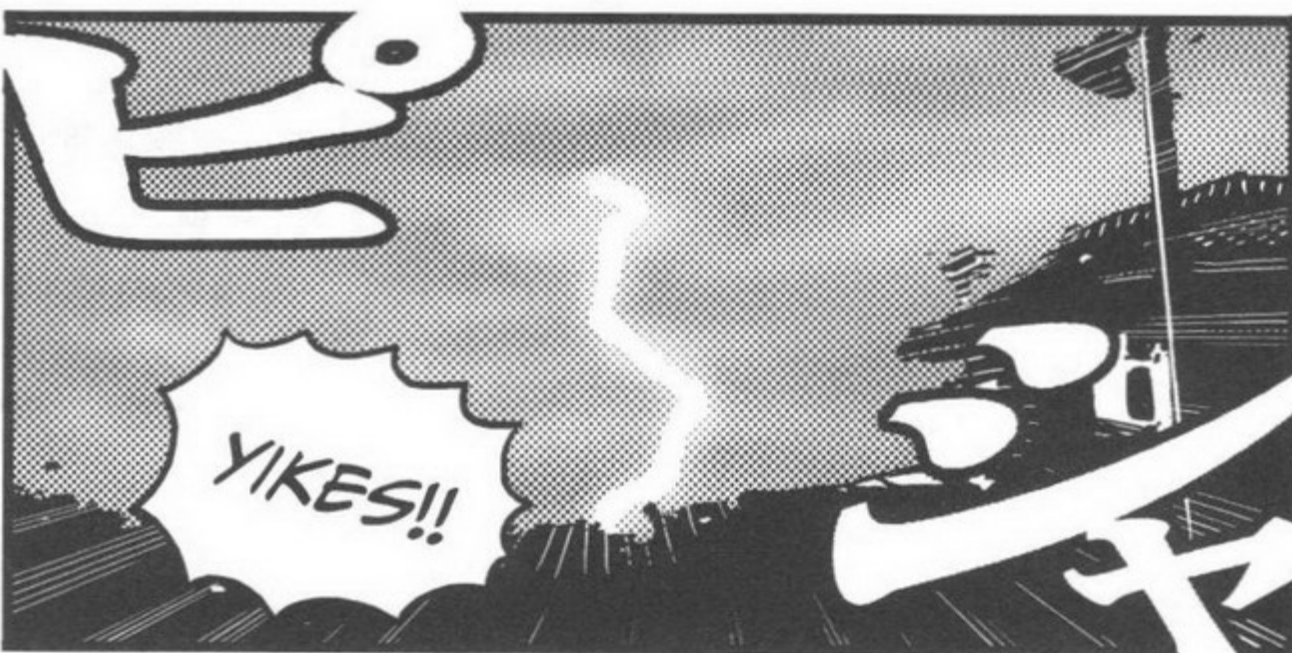

YIKES!!

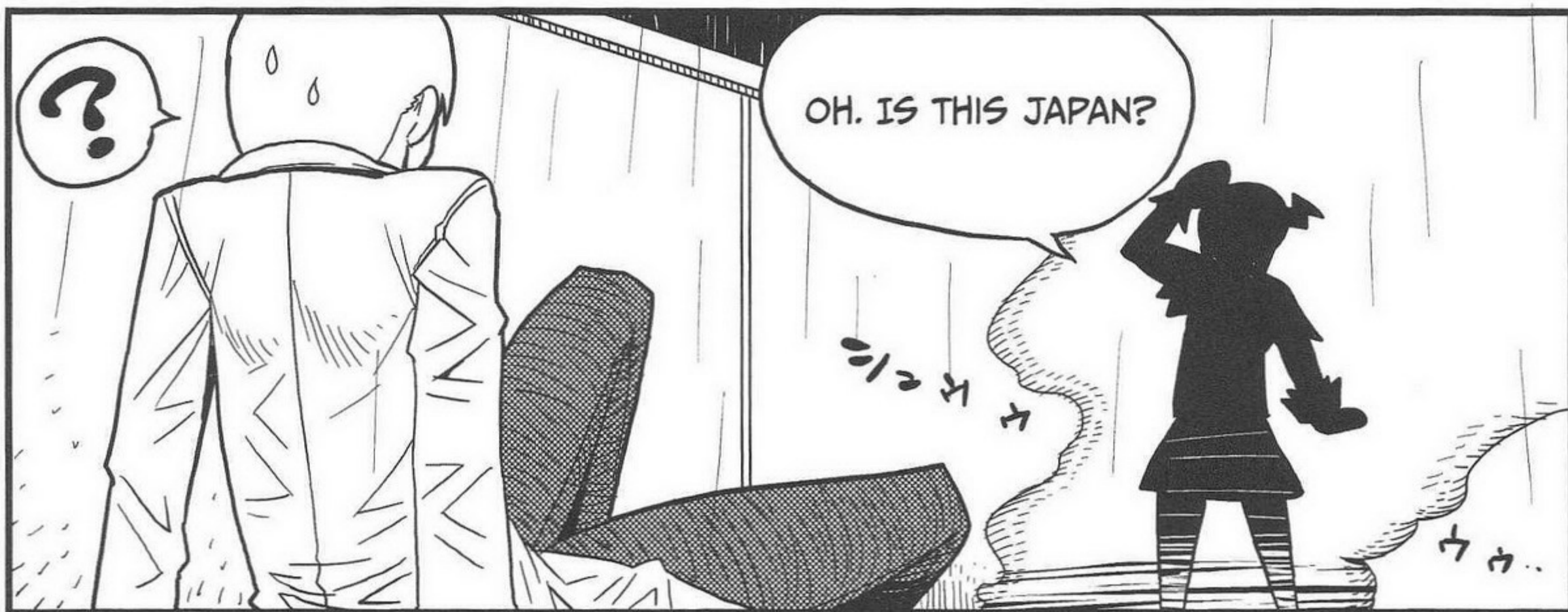

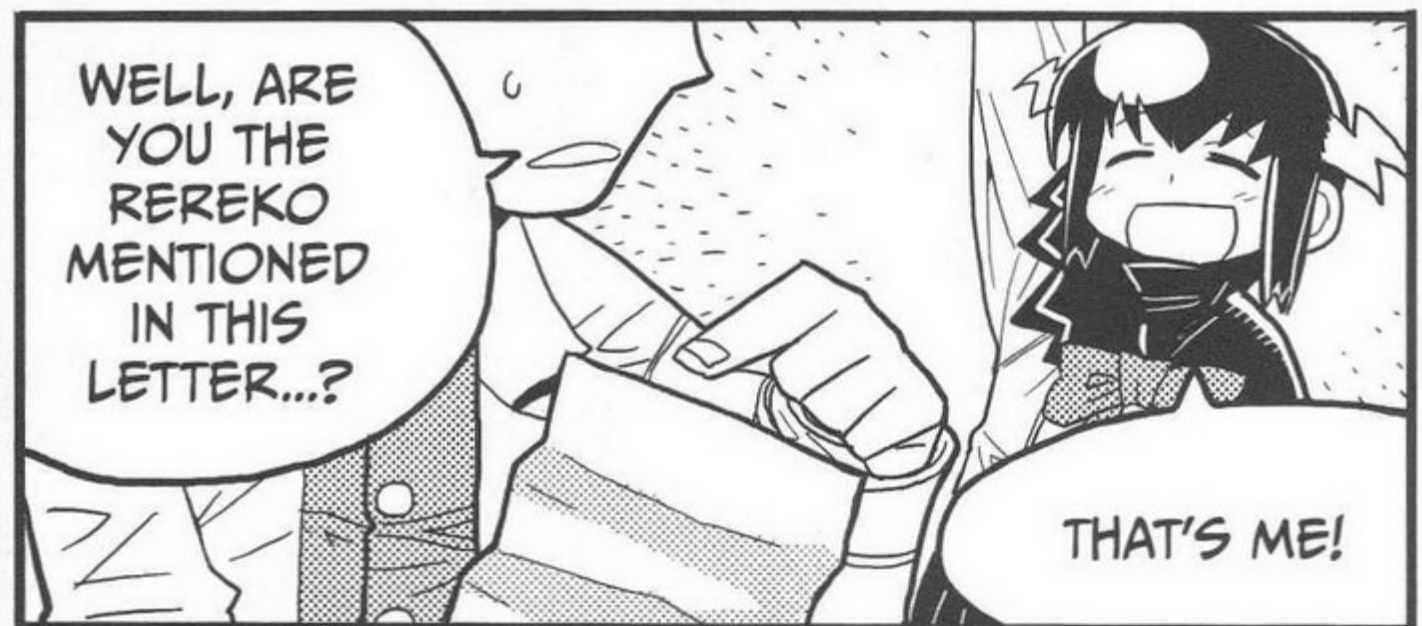
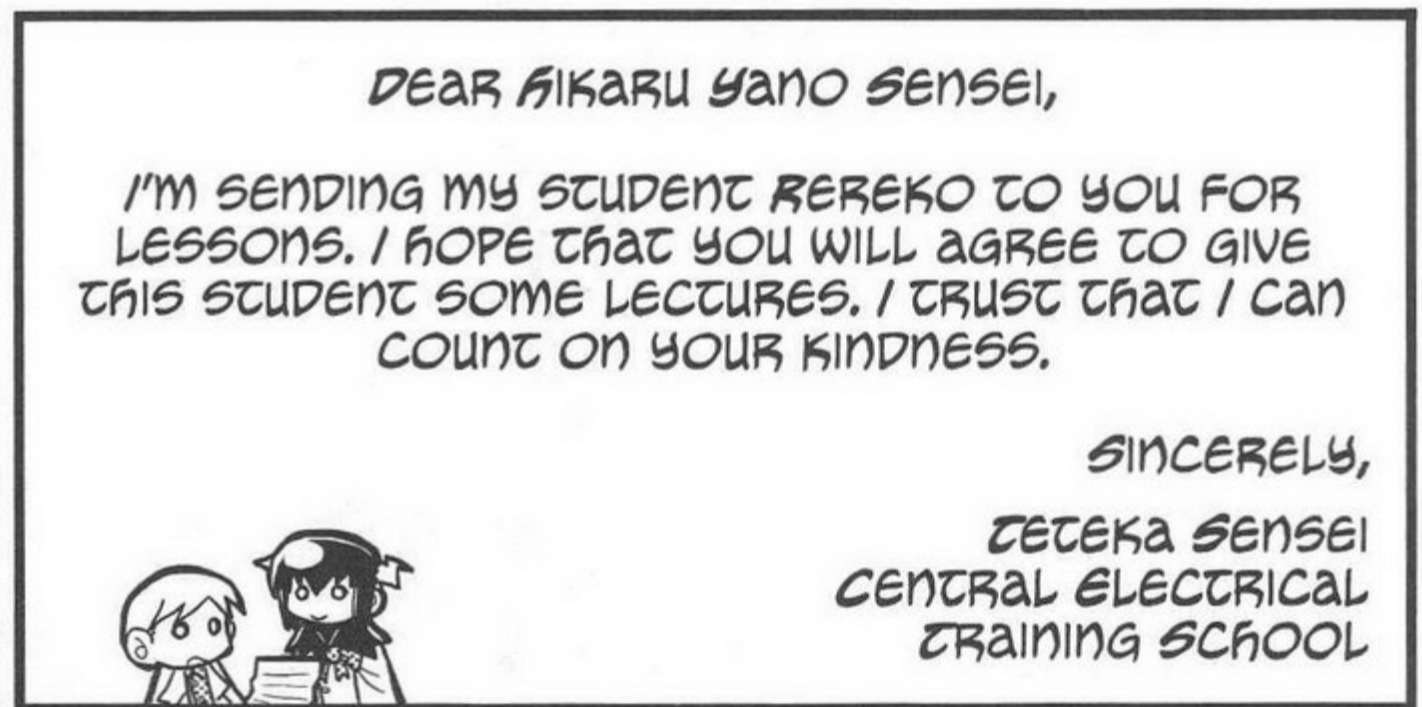
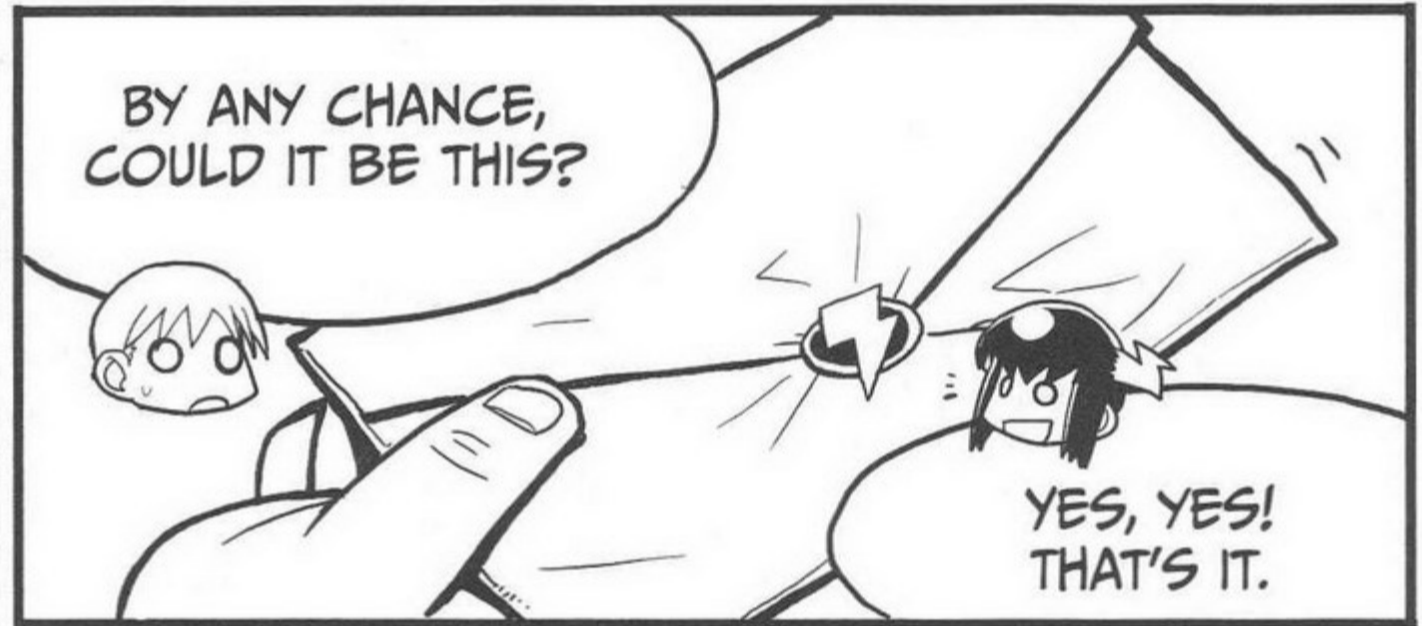

OKAY! BUT...WHY ARE WE
STANDING AROUND TALKING
IN THE RAIN? CAN YOU GIVE
ME SOME MORE DETAILS AT
MY HOUSE?

YES, CERTAINLY!

...AT HIKARU'S APARTMENT

I'M SORRY, BUT IT'S
A LITTLE MESSY.

CREAK

NO
PROBLEM!
I'M
SORRY TO
BOTHER...

TOWEL...
A TOWEL...
IS THAT IT?

YOU...?!

LET'S
SEE...

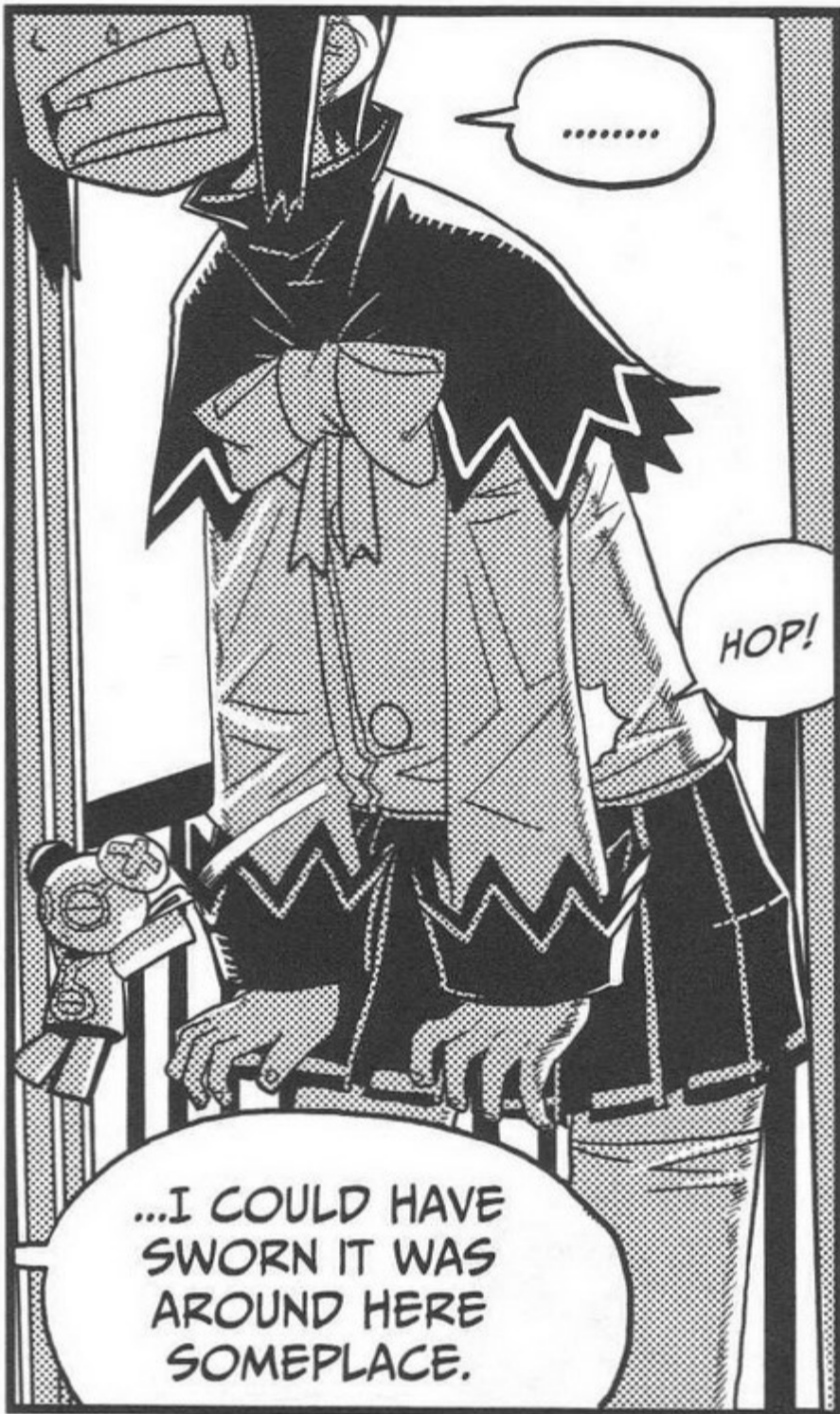

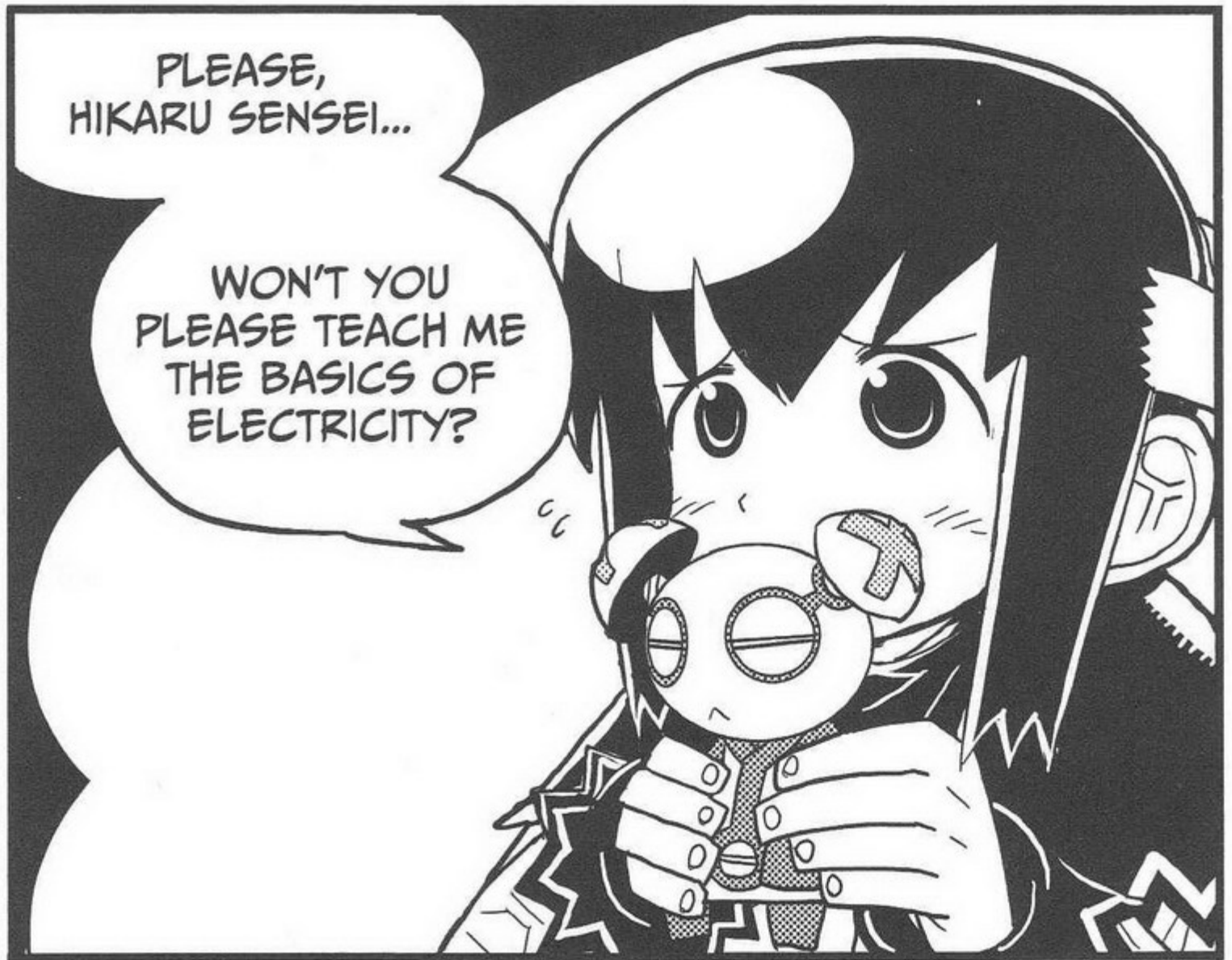



1

WHAT IS ELECTRICITY?

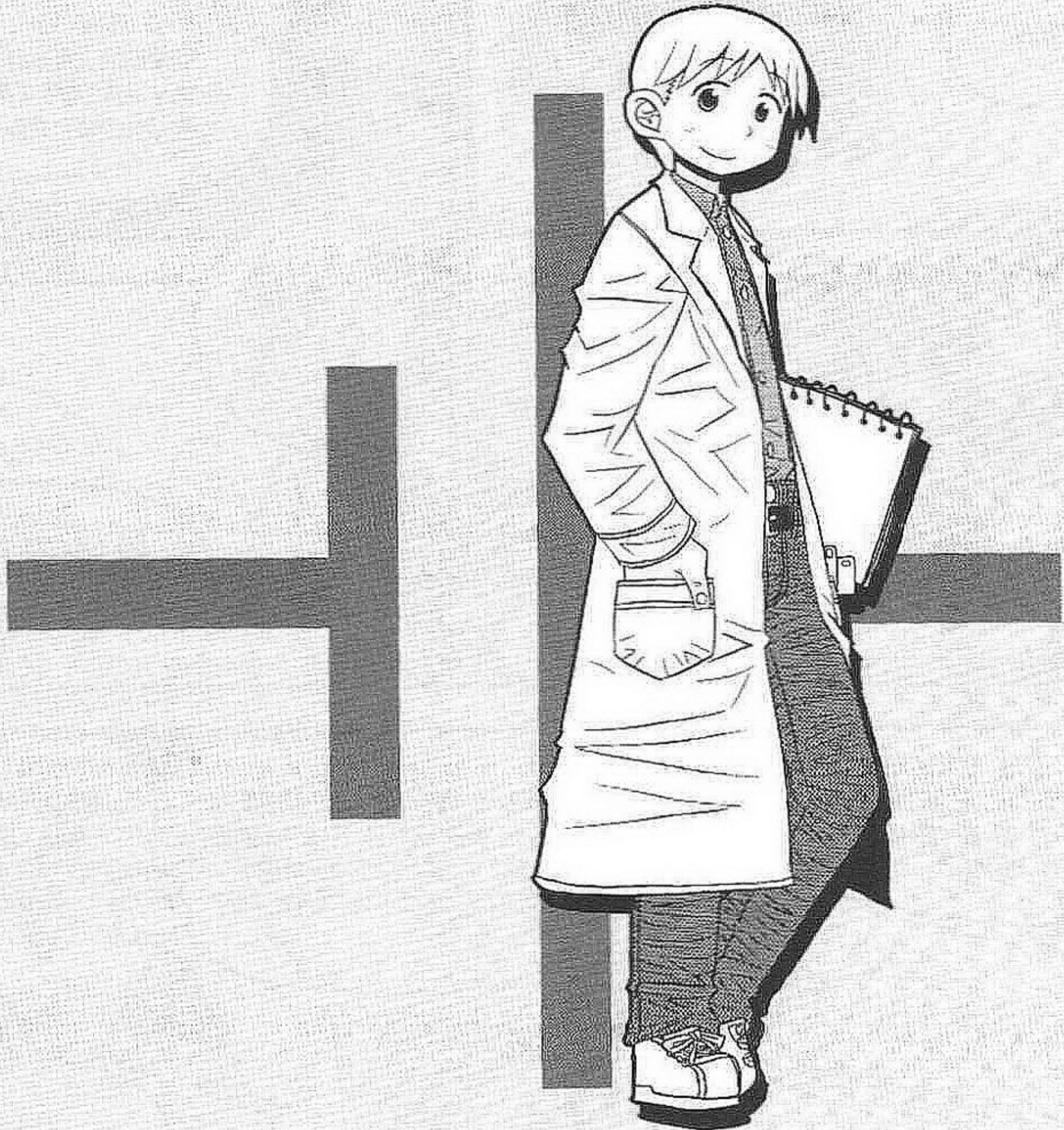

ELECTRICITY AND EVERYDAY LIFE

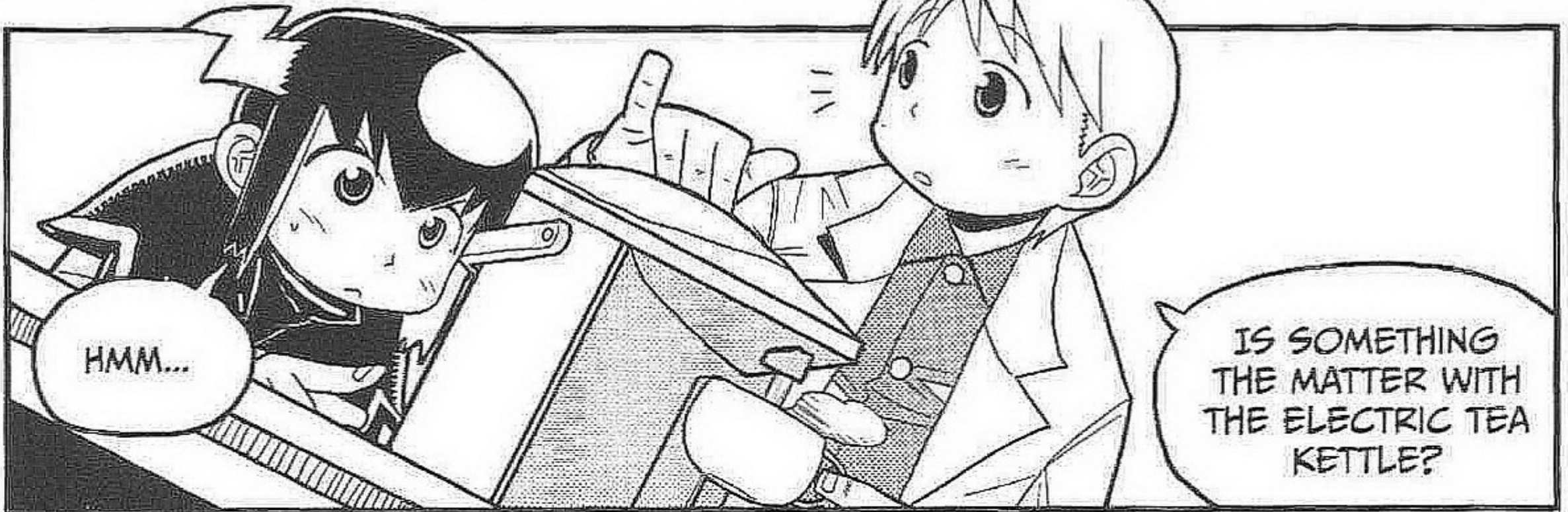

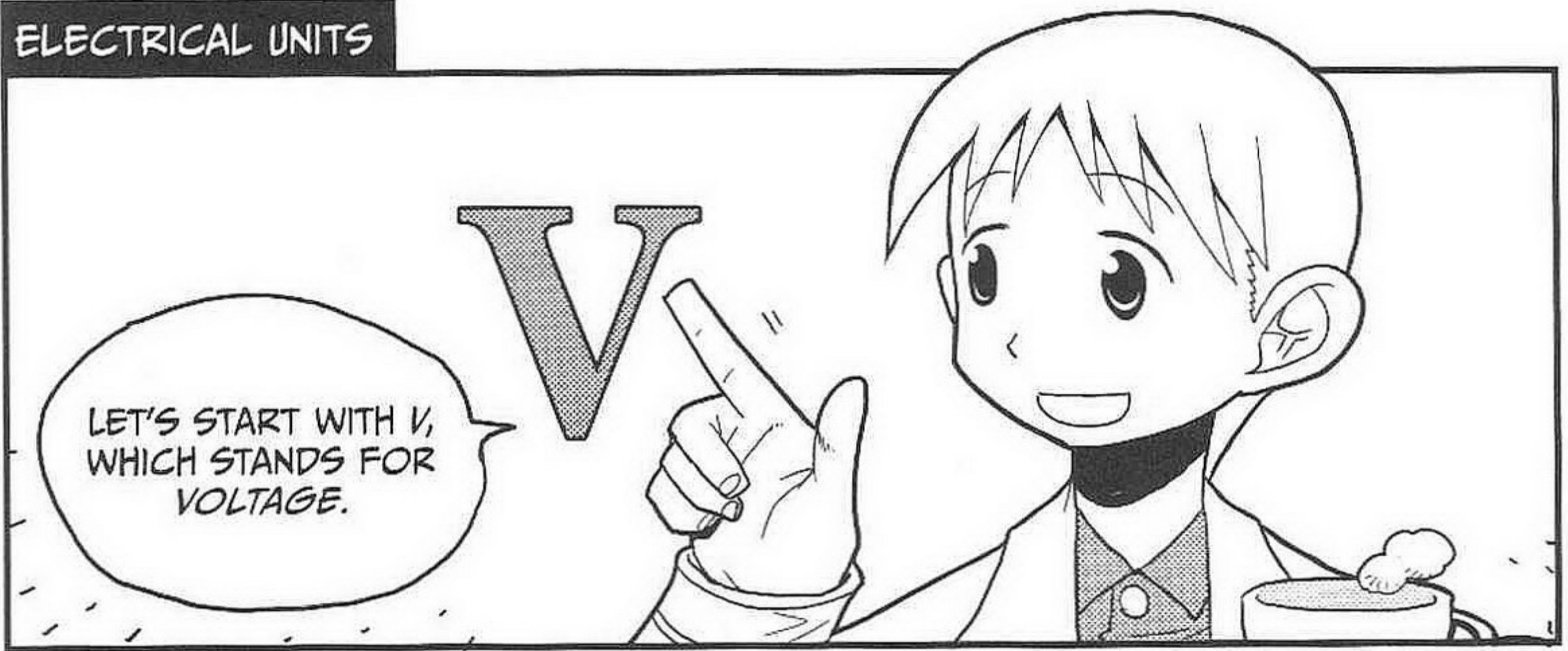

LET'S START WITH V, WHICH STANDS FOR VOLTAGE.

V

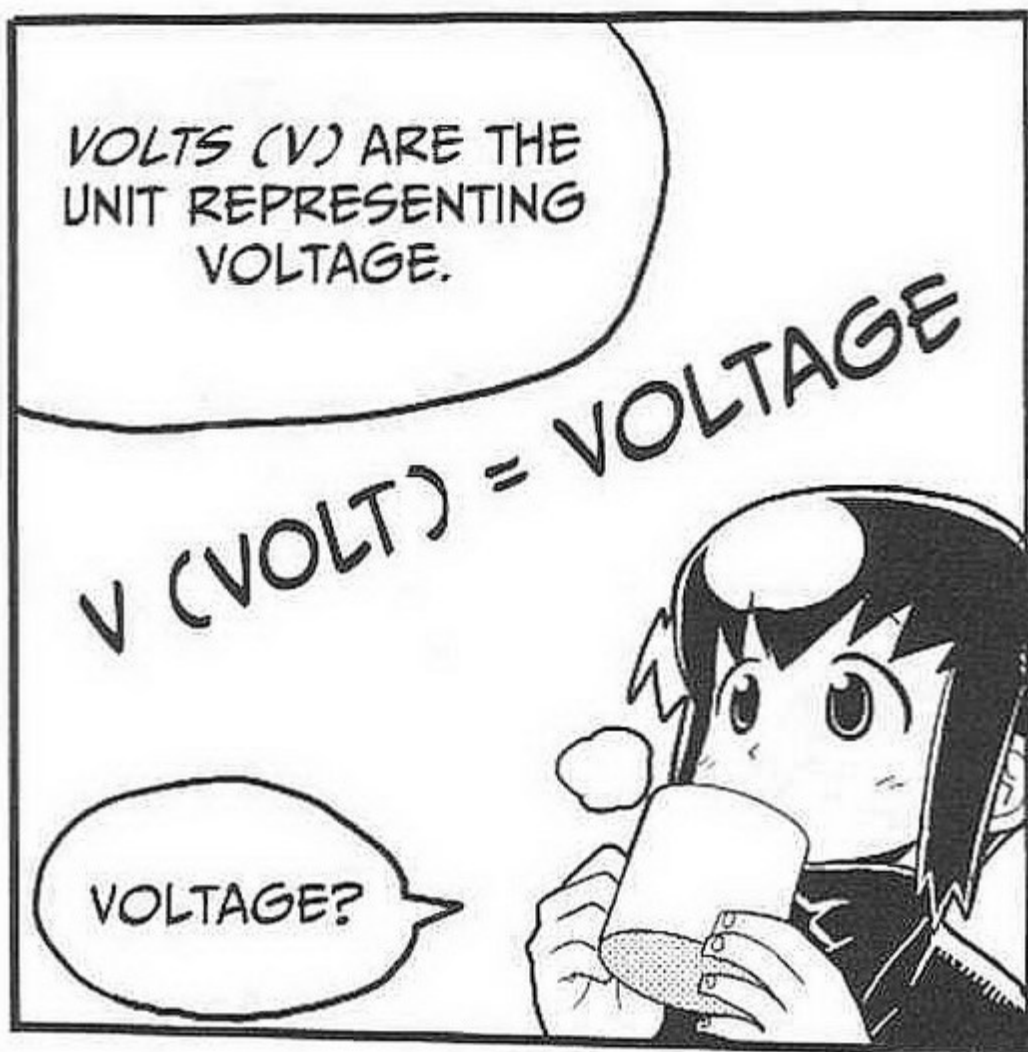

VOLTS (V) ARE THE UNIT REPRESENTING VOLTAGE.

V (VOLT) = VOLTAGE

VOLTAGE?

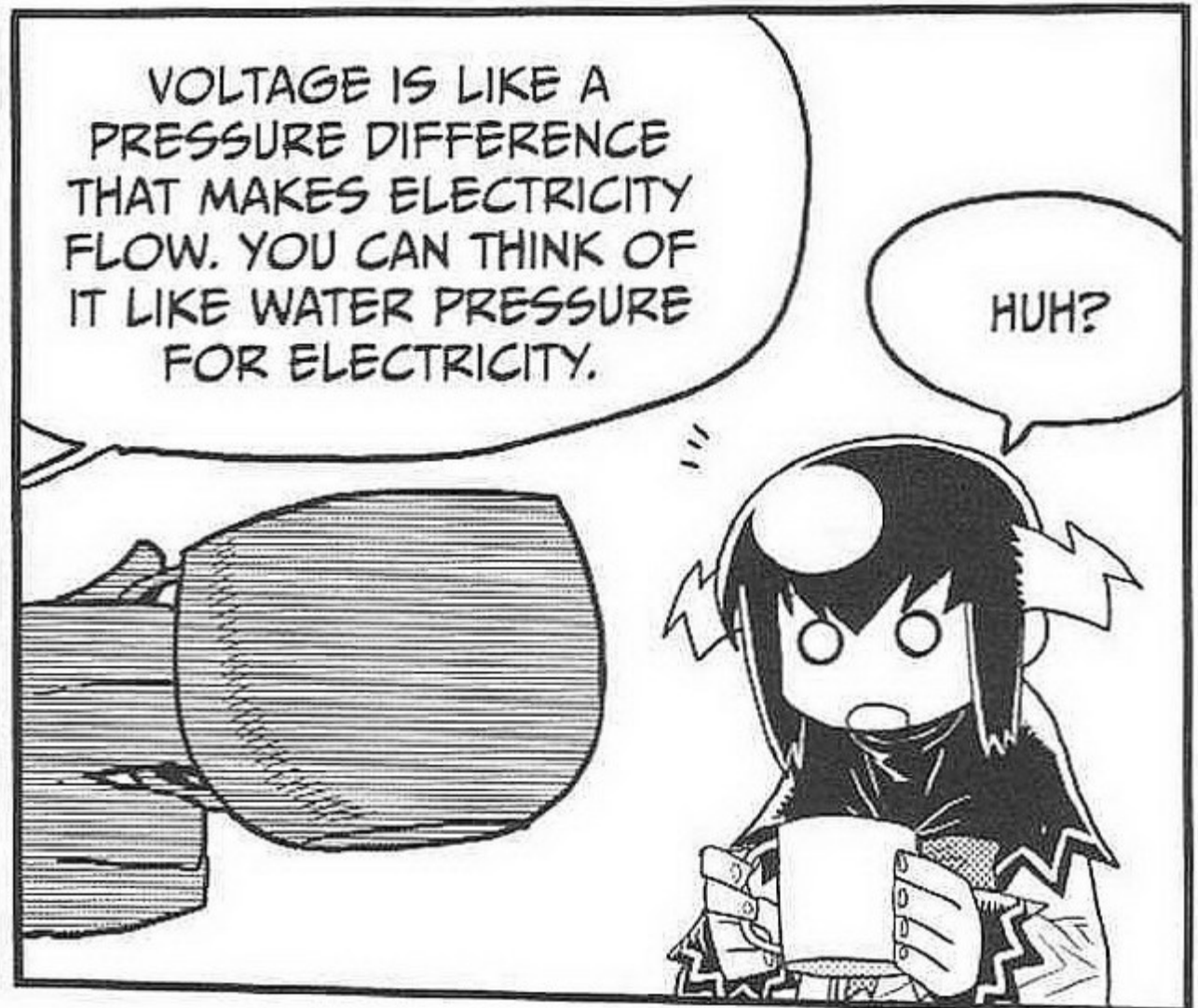

VOLTAGE IS LIKE A PRESSURE DIFFERENCE THAT MAKES ELECTRICITY FLOW. YOU CAN THINK OF IT LIKE WATER PRESSURE FOR ELECTRICITY.

HUH?



THE HEIGHT OF WATER VIEWED FROM A GIVEN REFERENCE POINT IS CALLED THE WATER LEVEL. ELECTRICITY ALSO HAS A COMPARABLE CONCEPT CALLED POTENTIAL DIFFERENCE.

THE UNITS FOR POTENTIAL DIFFERENCE ARE ALSO V.

IS THAT SO?

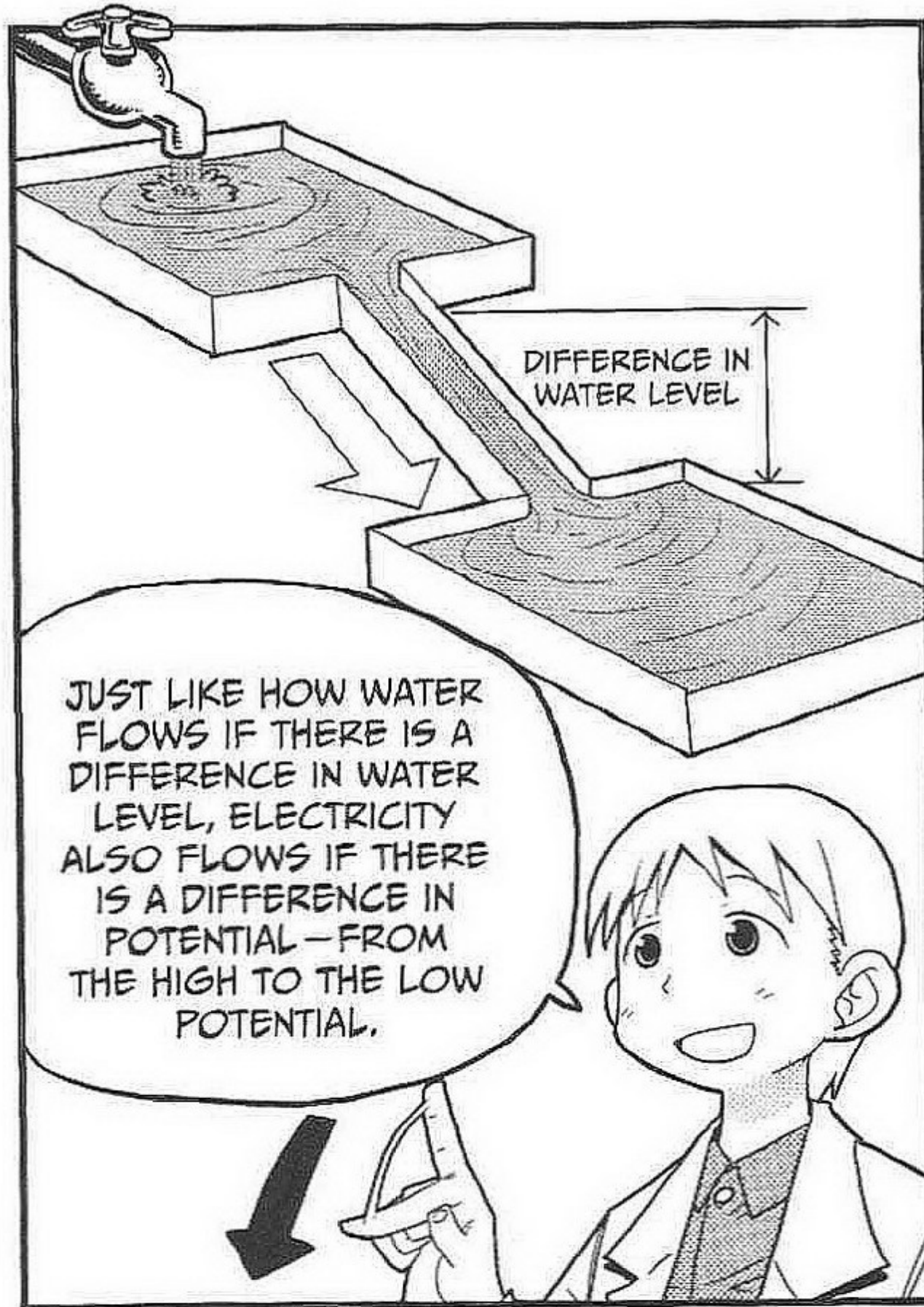

VOLTAGE IS THE DIFFERENCE IN POTENTIAL BETWEEN TWO POINTS.

DIFFERENCE IN WATER LEVEL = DIFFERENCE IN POTENTIAL = VOLTAGE

JUST LIKE HOW WATER FLOWS IF THERE IS A DIFFERENCE IN WATER LEVEL, ELECTRICITY ALSO FLOWS IF THERE IS A DIFFERENCE IN POTENTIAL - FROM THE HIGH TO THE LOW POTENTIAL.

ON THE OTHER HAND, A (AMPERE OR AMP FOR SHORT) IS THE UNIT REPRESENTING ELECTRIC CURRENT.

A

CURRENT IS THE AMOUNT OF ELECTRICITY FLOWING PER SECOND THROUGH AN ELECTRIC LINE. IN TERMS OF WATER, THIS WOULD BE THE WATER VOLUME PER SECOND.

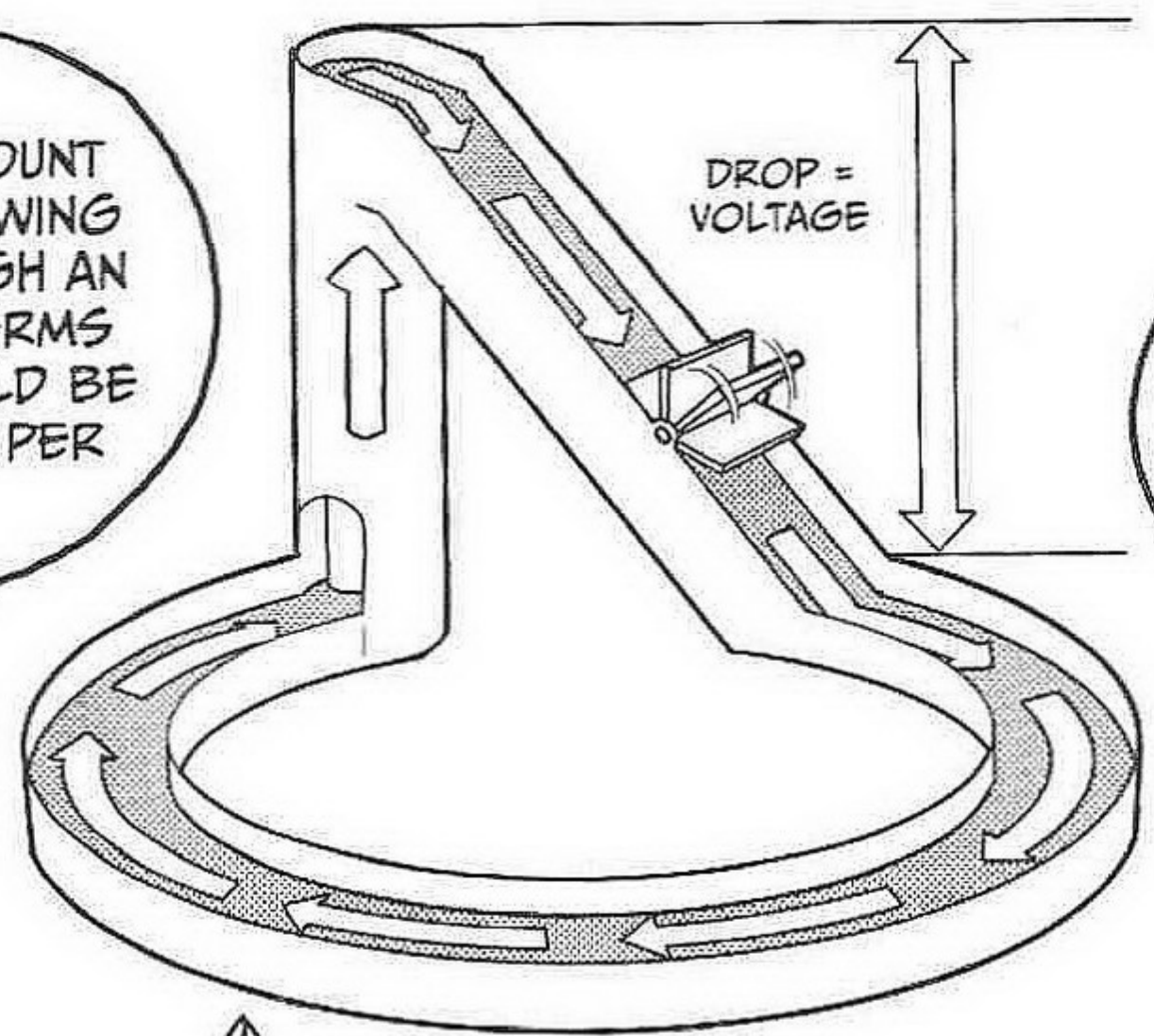

THIS MAKES ME WANT TO EAT NAGASHI SOMEN - FLOWING NOODLES!



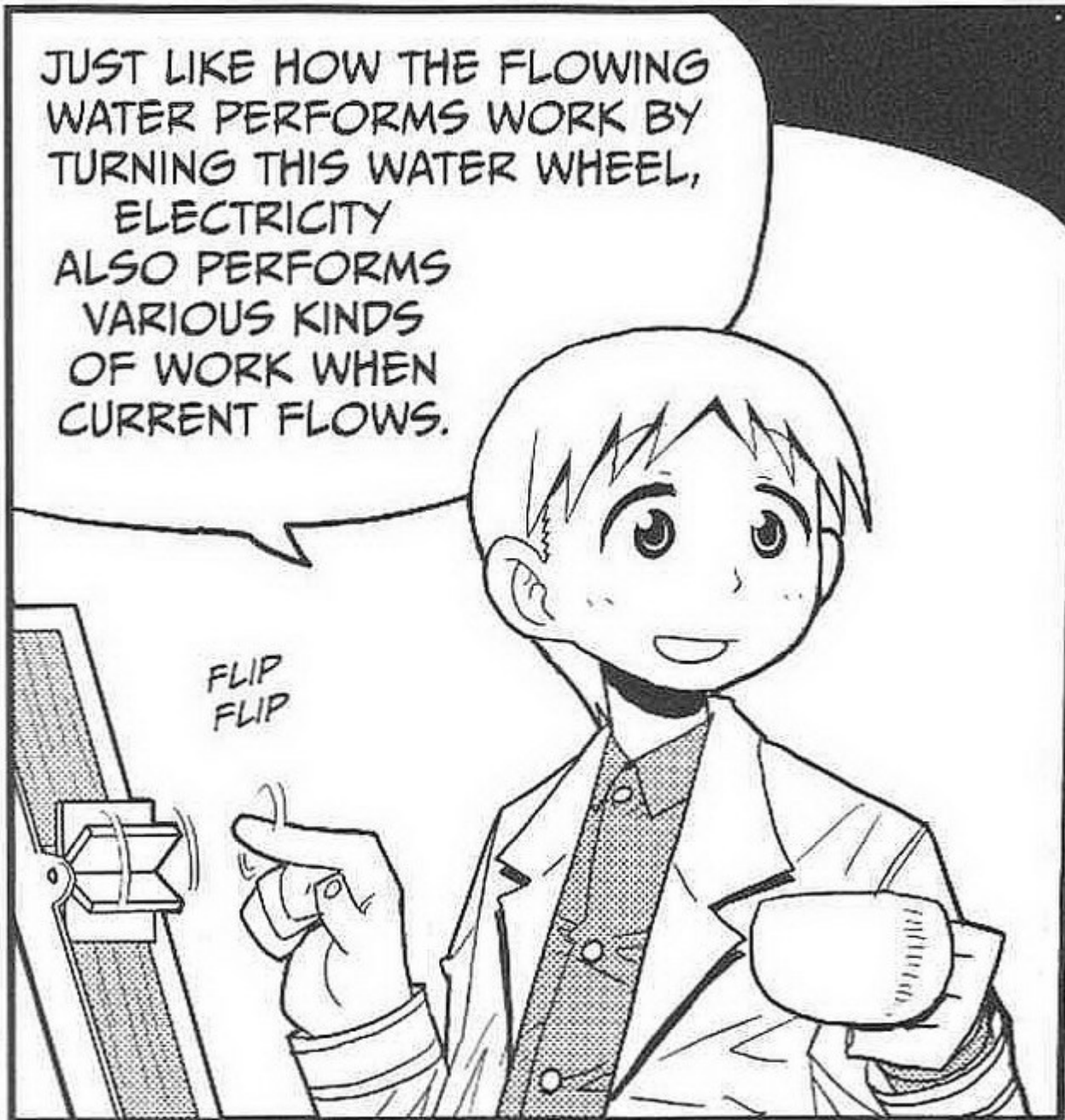

JUST LIKE HOW THE FLOWING WATER PERFORMS WORK BY TURNING THIS WATER WHEEL, ELECTRICITY ALSO PERFORMS VARIOUS KINDS OF WORK WHEN CURRENT FLOWS.

FLIP
FLIP



DOES IT COOK THE SOMEN?

ENOUGH ABOUT THE SOMEN ALREADY!



OKAY,
SO WHAT IS W?

W

W (WATT) IS THE UNIT REPRESENTING ELECTRIC POWER (CONSUMED POWER).

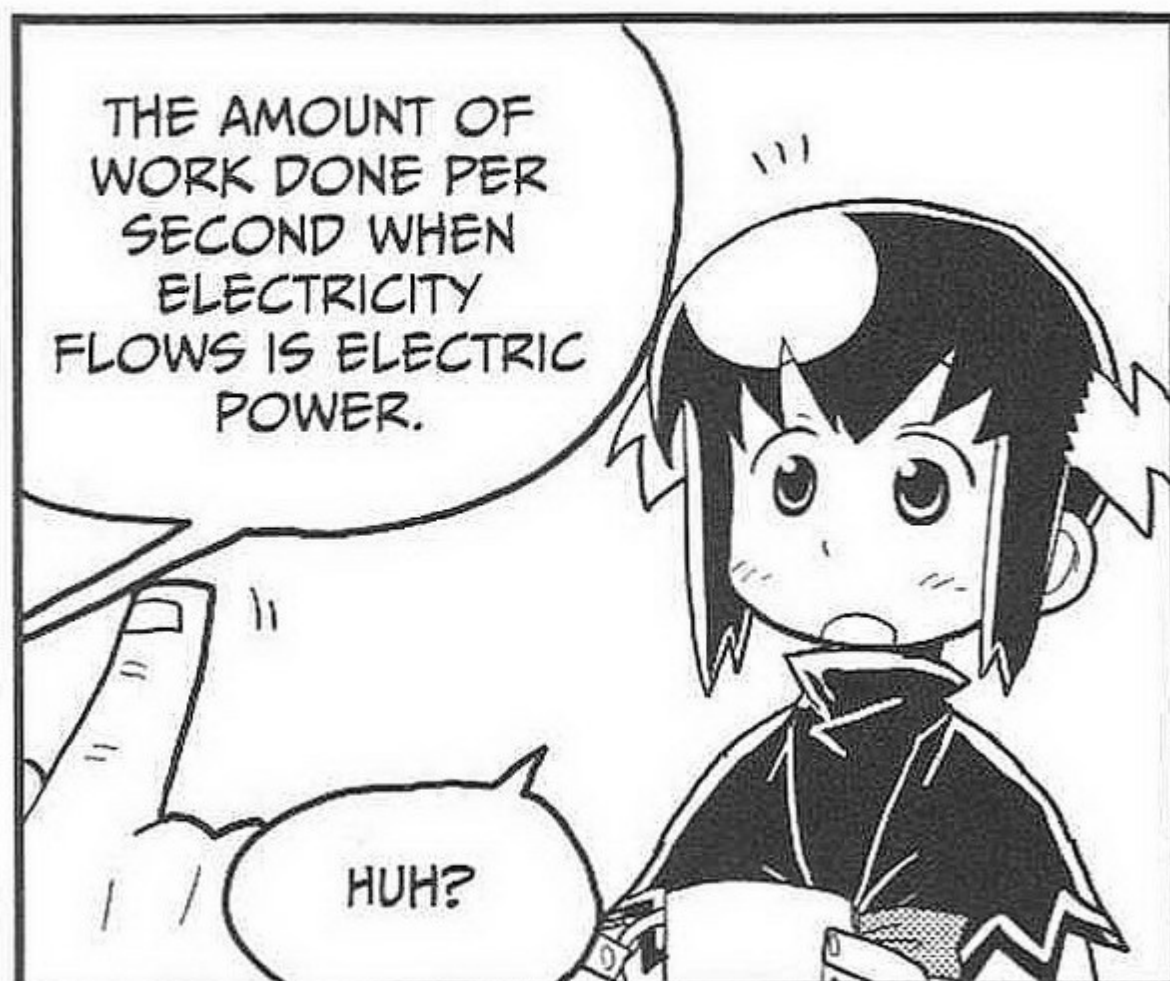

THE AMOUNT OF WORK DONE PER SECOND WHEN ELECTRICITY FLOWS IS ELECTRIC POWER.

HUH?

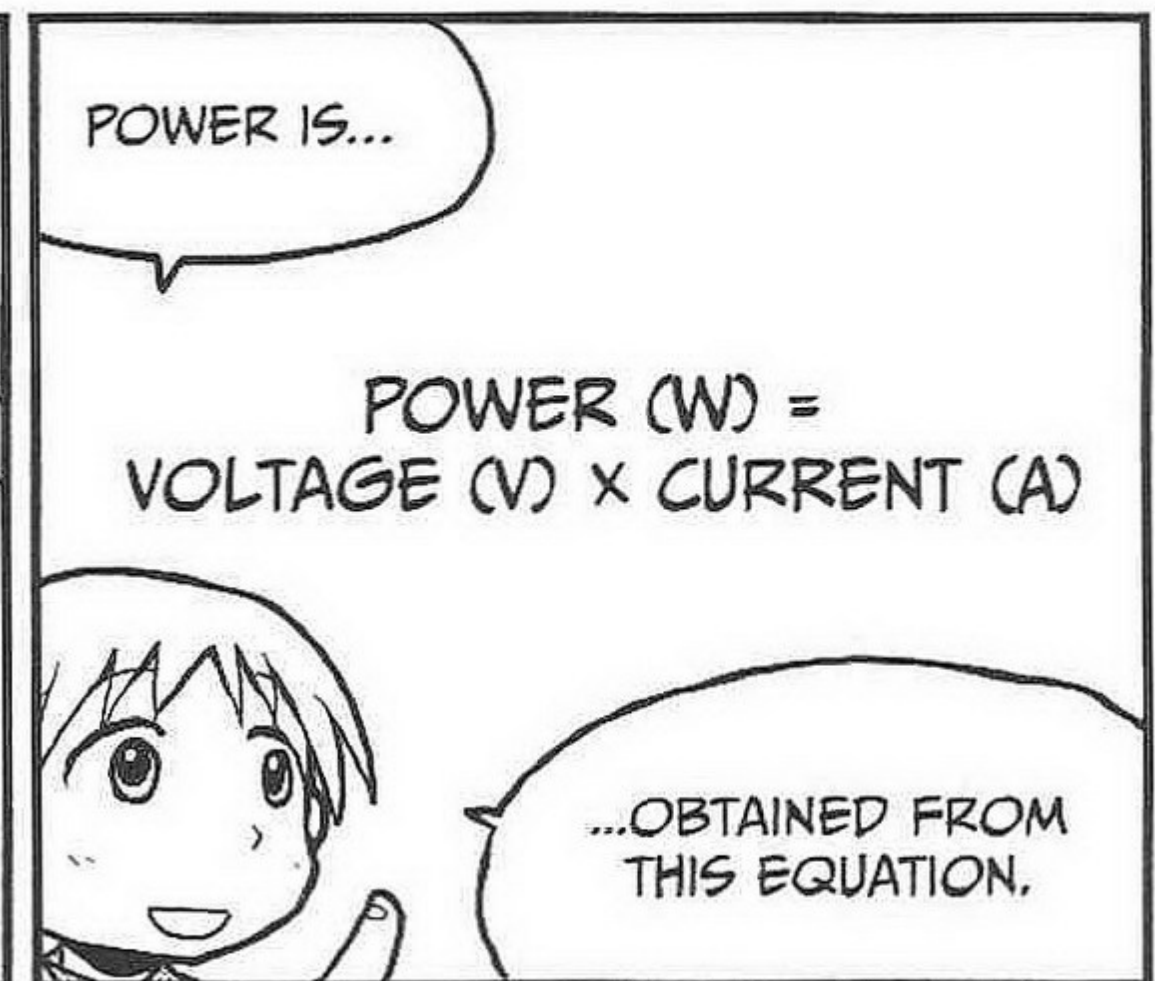

POWER IS...

POWER (W) =
VOLTAGE (V) X CURRENT (A)

...OBTAINED FROM THIS EQUATION.

SINCE WE CAN REWRITE THIS EQUATION AS

$$\text{CURRENT (A)} = \frac{\text{POWER (W)}}{\text{VOLTAGE (V)}}$$

...WE CAN ALSO EASILY FIND THE CURRENT.

FOR THIS ELECTRIC TEA KETTLE...

...WE HAVE

$$\frac{1000\text{W}}{100\text{V}} = 10\text{A}$$

DON'T WE?

THAT'S RIGHT!

電気使用量のお知らせ

〒100-0001 東京都千代田区千代田

0年0月分

ご使用量 310kWh

請求予定金額 6,580円

| | |
|---------|--------|
| 基本料金 | 0円 |
| 電力1段料金 | 1,700円 |
| 電力2段料金 | 3,500円 |
| 電力3段料金 | 2,000円 |
| 1段料金調整 | 500円 |
| 電化副産物料金 | 160円 |
| 口産品送料 | 50円 |
| 消費税等相当額 | 307円 |
| 引当金 | 500円 |

契約種別 従量電灯B

契約 30A

| | |
|--------|-------|
| 基本料金 | 1421円 |
| 電力1段料金 | 1111円 |
| 電力2段料金 | 300円 |
| 電力3段料金 | 111円 |

00000-00000-000

東京電力株式会社

NOW LET'S LOOK AT ENERGY. THE MONTHLY ELECTRIC BILL HAS THE UNIT KWH (KILOWATT HOUR) REPRESENTING THE AMOUNT OF ELECTRIC ENERGY A HOUSEHOLD USES...

YUP... I SEE IT!

THIS CAN BE OBTAINED BY MULTIPLYING POWER AND USAGE TIME.



FOR EXAMPLE, IF A 1200W APPLIANCE IS USED FOR 2 HOURS, HOW MANY KILOWATT HOURS WOULD THAT BE?



UM...1200 TIMES 2

IS 2400, ISN'T IT?

$1200W \times 2 \text{ HOURS} = 2400WH = 2.4KWH$

RIGHT, IT'S 2400WH (WATT HOURS). SO THAT'S 2.4KWH.

IF YOU KNOW THIS, YOU CAN FIGURE OUT THE ELECTRICAL UTILITY CHARGES FOR ANY APPLIANCE.



IF 1KWH COSTS 20 YEN, RUNNING THE TEA KETTLE FOR 2 HOURS (2.4KWH) WILL COST 48 YEN!

ELECTRICITY IN THE HOME

YOU KNOW THAT IF SEVERAL ELECTRONIC APPLIANCES THAT CONSUME A LARGE AMOUNT OF POWER ARE USED AT THE SAME TIME, THE CIRCUIT BREAKER MAY TRIP AND "BLOW A FUSE," RIGHT?

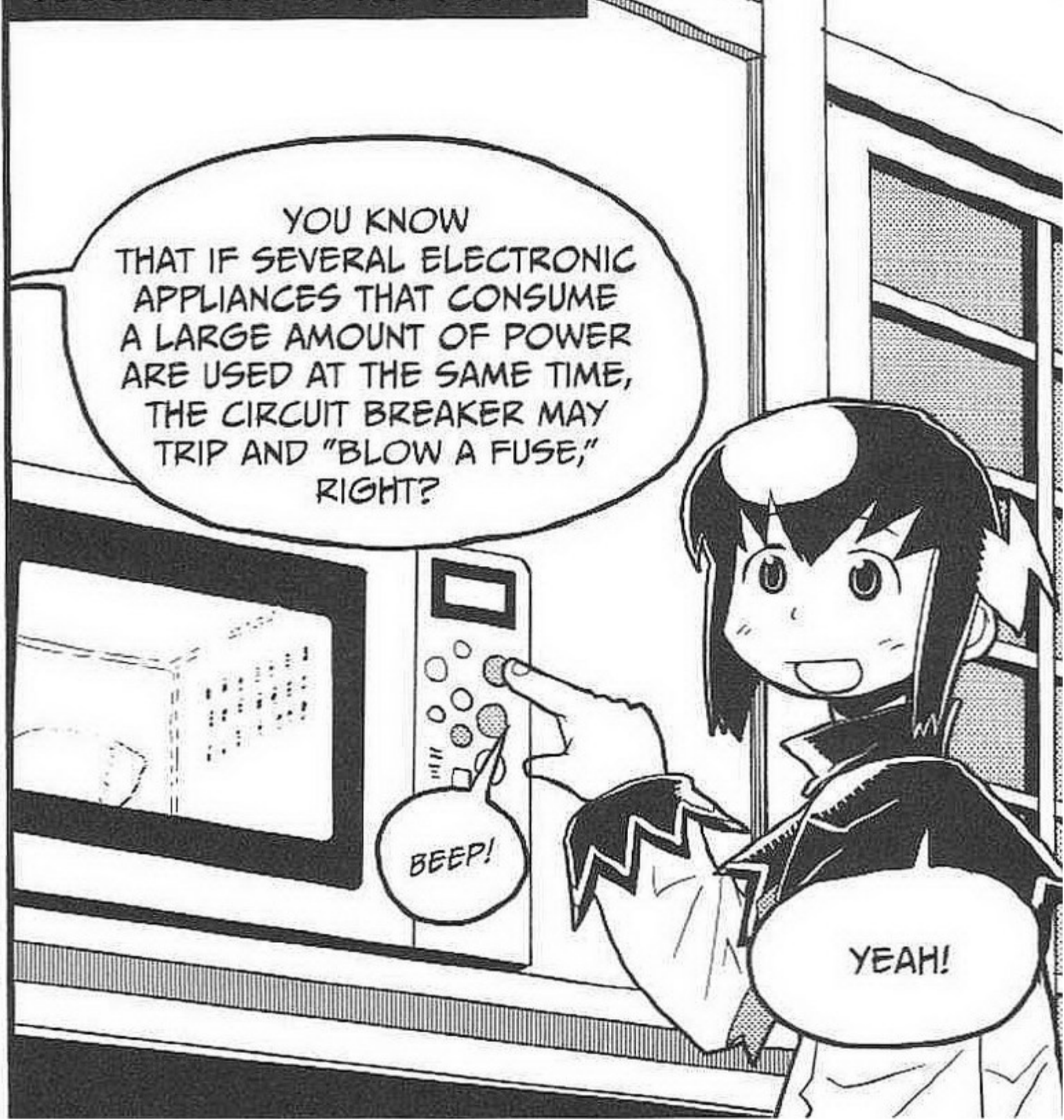

YEAH!

WELL, WHY DOES THE BREAKER TRIP, AND WHAT CAN WE DO TO PREVENT IT FROM HAPPENING?

LET'S THINK ABOUT THIS TOGETHER.

OKAY.

FIRST, LET'S TALK ABOUT THE FLOW OF ELECTRICITY COMING TO THE HOUSE.

CLICK!

ALL RIGHT!

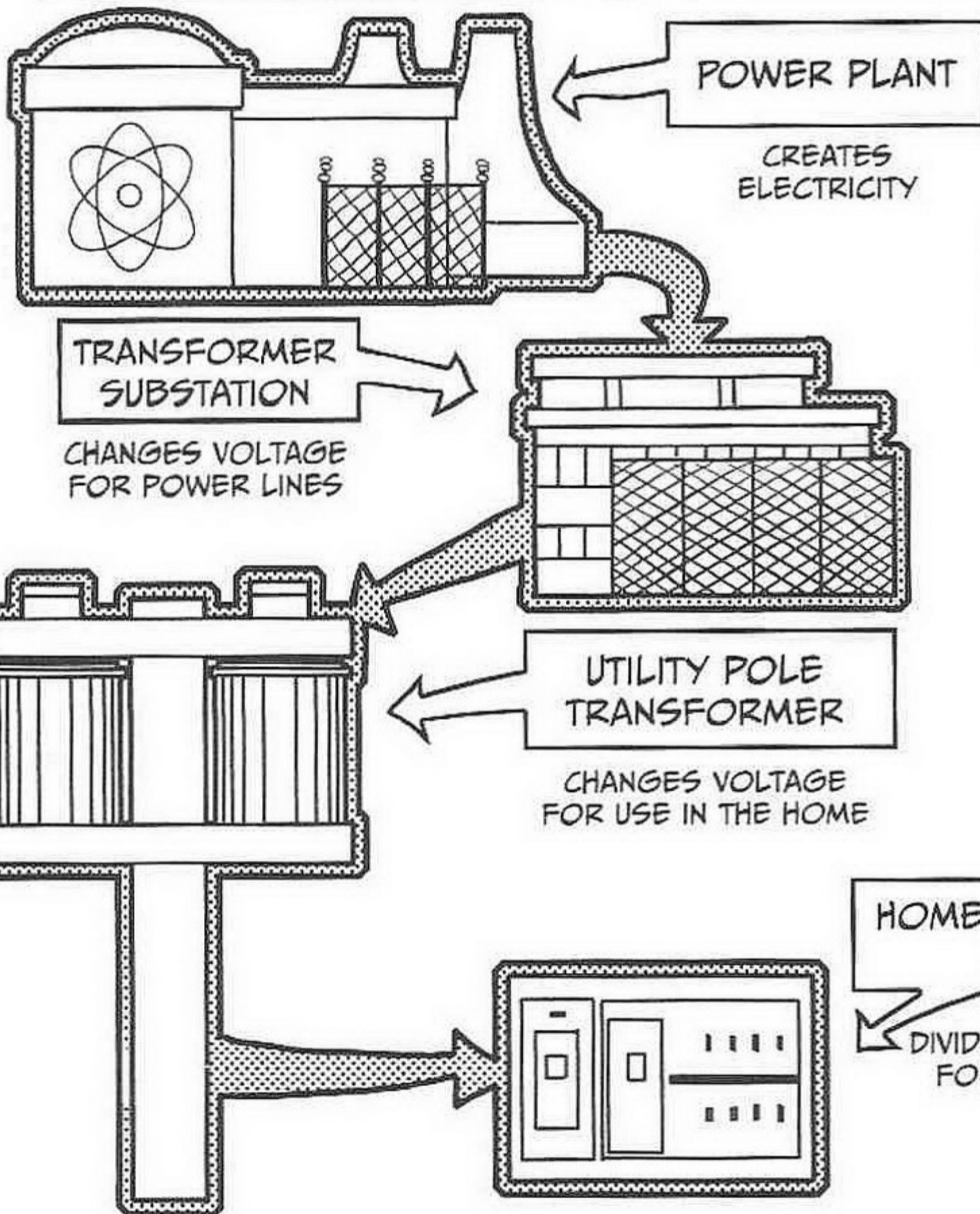

THE ELECTRICITY USED IN AN ORDINARY HOME IS CREATED AT A POWER PLANT AND DELIVERED TO EACH HOME BY ELECTRIC LINES, AFTER IT PASSES THROUGH TRANSFORMER SUBSTATIONS OR TRANSFORMERS ON UTILITY POLES.



A DISTRIBUTION BOARD DIVIDES ELECTRICITY FOR EACH ROOM IN THE HOUSE. THE ELECTRICITY THAT ENTERS THE DISTRIBUTION BOARD

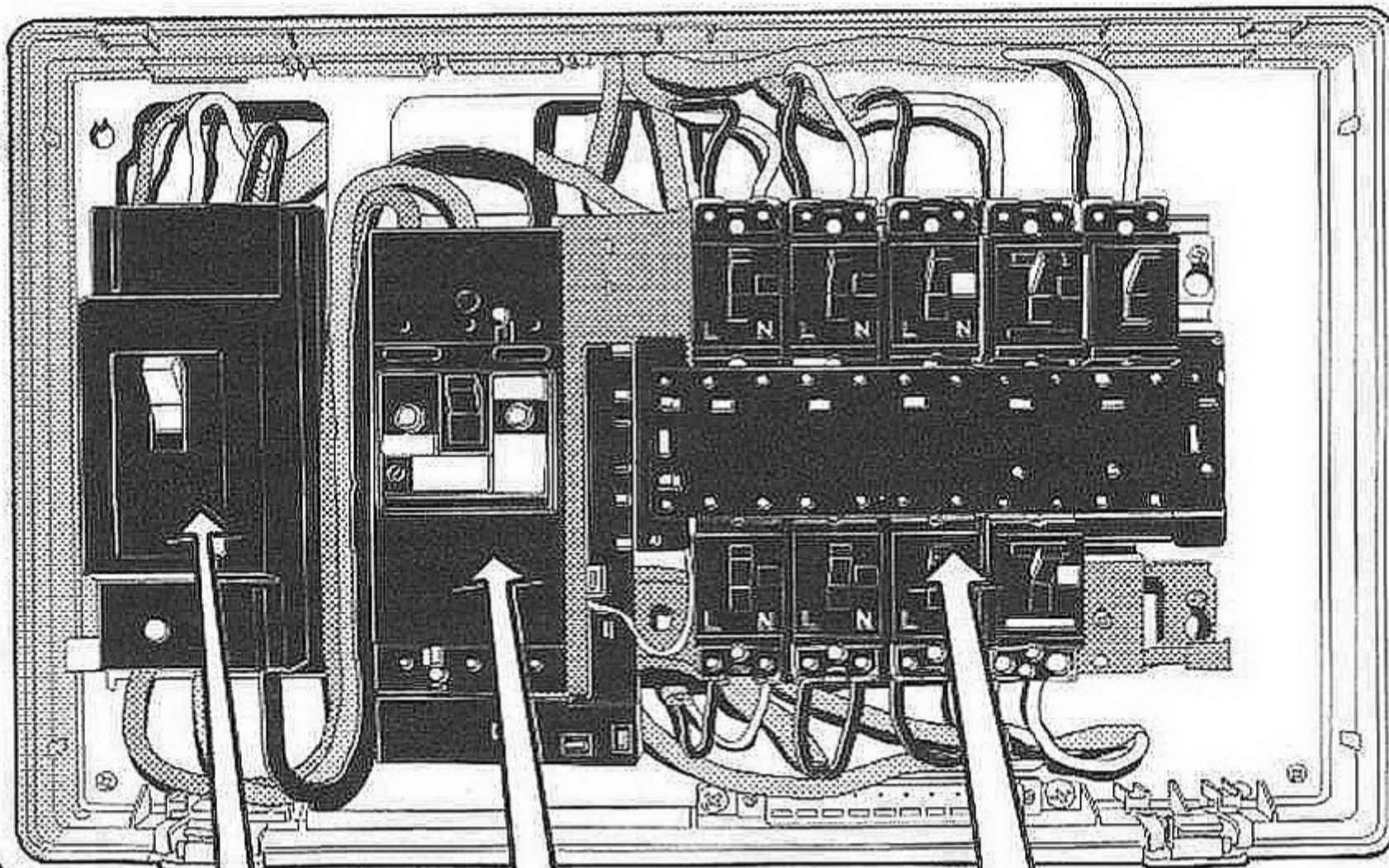

PASSES THROUGH A CURRENT LIMITER, ENTERS A LEAKAGE CIRCUIT BREAKER, AND IS DIVIDED AMONG MULTIPLE SAFETY BREAKERS.



CURRENT LIMITER

LEAKAGE CIRCUIT BREAKER

SAFETY BREAKERS

THE INSIDE OF A DISTRIBUTION BOARD LOOKS LIKE THIS.

HUH.



IF THE TOTAL CURRENT FLOWING THROUGH MULTIPLE SAFETY BREAKERS EXCEEDS THE MAXIMUM CURRENT VALUE, THE CURRENT LIMITER WILL TRIP.

IN MY HOUSE, THE MAXIMUM CURRENT VALUE ALLOWED IS 20A.

SO IF THE CURRENT IS MORE THAN 20A, IT WILL TRIP FOR SAFETY, RIGHT?



THESE ARE THE SAFETY BREAKERS!

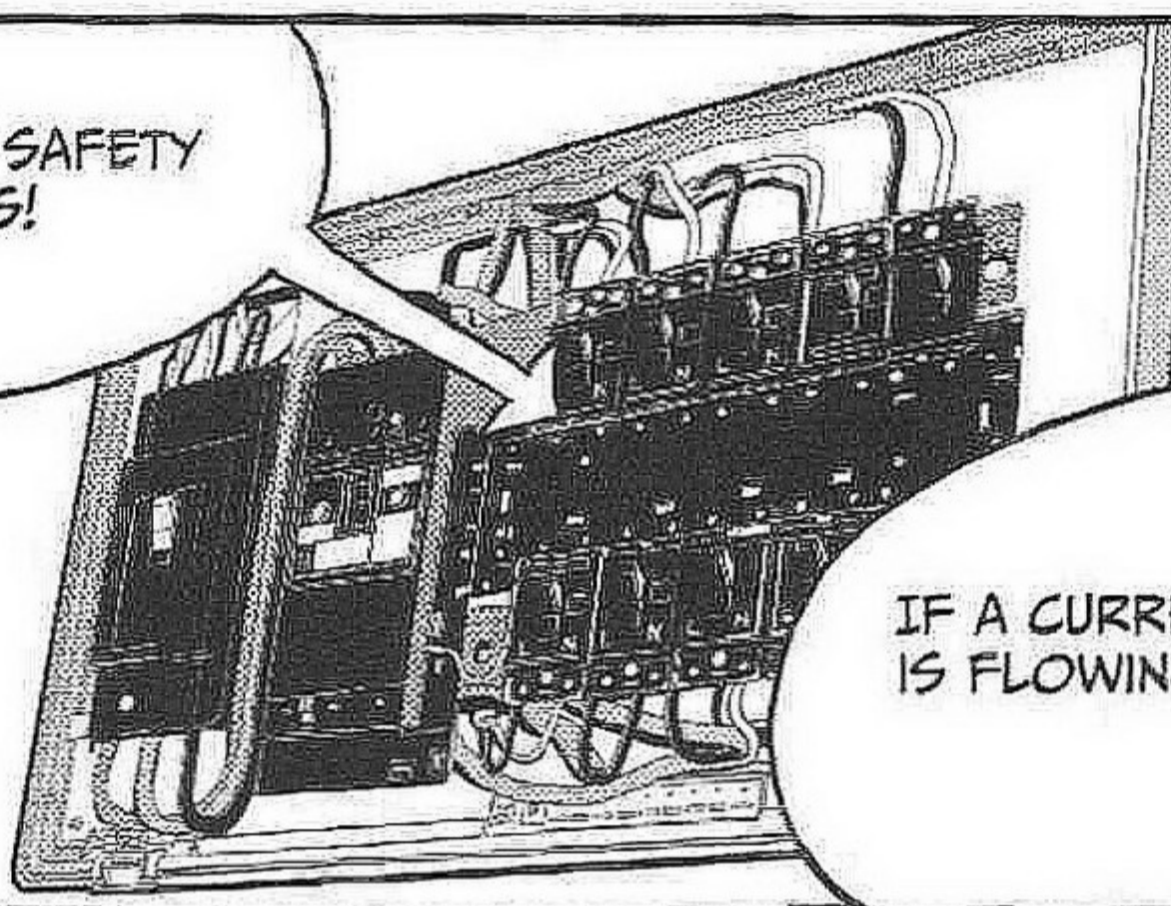

IF A CURRENT OF 20A OR MORE IS FLOWING, THIS WILL TRIP FOR SAFETY.

SO, IF THE TOTAL ELECTRICITY USED BY THE ELECTRONIC APPLIANCES CONNECTED TO ONE SAFETY BREAKER DOES NOT EXCEED 20A...

SINCE THE VOLTAGE OF A HOUSEHOLD ELECTRICAL OUTLET IS ALWAYS 120V, LET'S TRY CALCULATING THE TOTAL POWER USED BY THE APPLIANCES CONNECTED TO ONE SAFETY BREAKER AND SEE IF IT EXCEEDS THE LIMIT.

FOR EXAMPLE, IF WE TRY USING THE ELECTRIC KETTLE AND THE RICE COOKER...



ELECTRIC TEA KETTLE
 $840W / 120V = 7.0A$



RICE COOKER
 $1500W / 120V = 12.5A$

$$7.0A + 12.5A = 19.5A$$

...THE SAFETY BREAKER WILL NOT TRIP.

THIS COMBINATION JUST MAKES IT BY A WHISKER...

20A HAS NOT BEEN EXCEEDED.



EVEN IF IT WERE EXCEEDED, WE COULD AVOID TRIPPING THE BREAKER BY NOT USING BOTH APPLIANCES AT THE SAME TIME, OR...

...WE COULD USE ONE OF THE APPLIANCES FROM AN OUTLET CONNECTED TO A DIFFERENT SAFETY BREAKER.

RIGHT!!!

HOWEVER, THERE IS STILL SOMETHING WE MUST BE CAREFUL ABOUT, EVEN IF THE BREAKER DOESN'T TRIP.

THERE IS A VALUE CALLED THE RATED CURRENT THAT IS DETERMINED FOR A NORMAL ELECTRICAL OUTLET.

IT IS GENERALLY 15A.

PLUG

PLUG

PLUG

PLUG

WHAT HAPPENS IF IT IS EXCEEDED?

WELL, EVEN IF THE TOTAL CURRENT EXCEEDS 15A WHEN MULTIPLE ELECTRONIC APPLIANCES ARE USED FROM ONE OUTLET, THE SAFETY BREAKER WILL NOT TRIP AS LONG AS THE CURRENT DOES NOT EXCEED 20A, BUT...



IF YOU CONTINUE TO USE THEM LIKE THIS FOR A LONG TIME, THE OUTLET OR PLUG WILL GET HOT, WHICH IS DANGEROUS!

EEP!



...WELL, THIS ONE IS OKAY, SINCE IT'S NOT PLUGGED IN.

ACK, DON'T SCARE ME!



BUT FOR THIS REASON, LET'S STOP USING SEVERAL ELECTRONIC APPLIANCES WITH HIGH POWER CONSUMPTION FROM A SINGLE OUTLET, OKAY?

Y...YES!!



YOU SHOULD ALSO BE CAREFUL WHEN I'M CHARGING!

HUH? DO YOU CONSUME THAT MUCH ELECTRICITY, YONOSUKE?



IT SHOULD BE OKAY IF WE CONNECT HIM TO AN OUTLET SEPARATE FROM OTHER ELECTRONIC APPLIANCES, RIGHT?

YES, BUT... MY ELECTRIC BILL WON'T BE OKAY!!!

AROUND 600 BC, THE GREEK PHILOSOPHER THALES DISCOVERED THAT WHEN AN AMBER ORNAMENT WAS RUBBED WITH A CLOTH, IT ATTRACTED FEATHERS OR PIECES OF LINT.



THALES



AH! IS THIS, BY ANY CHANCE...



...DUE TO STATIC ELECTRICITY!?

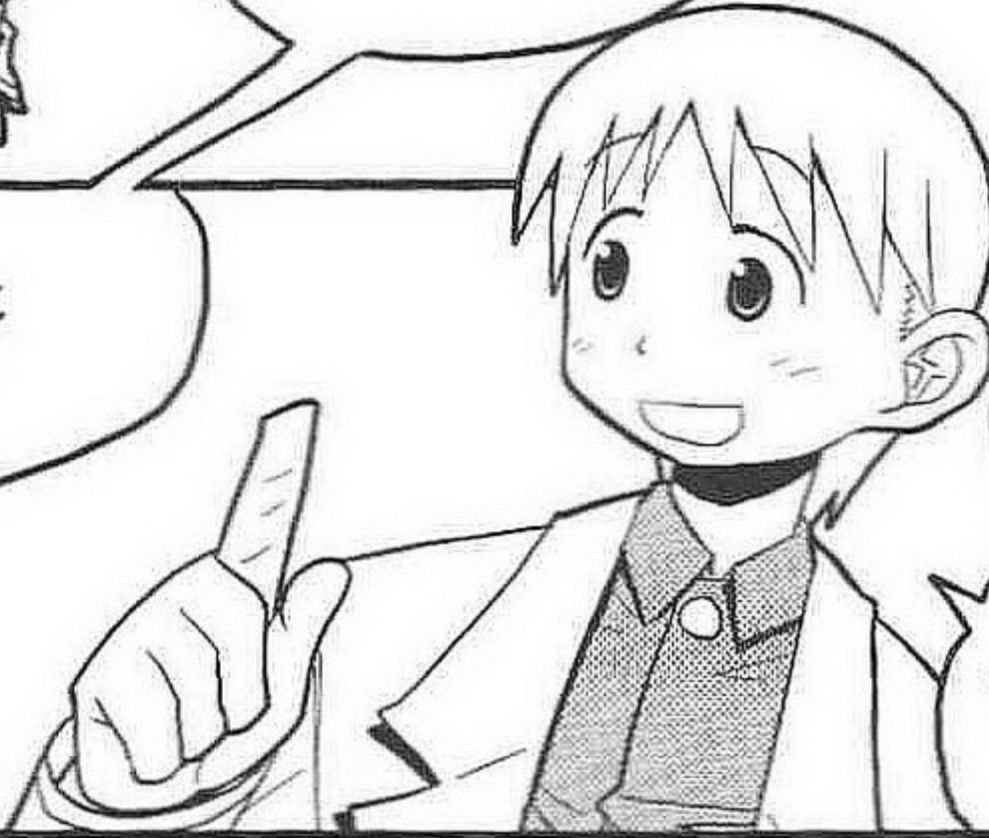

YEP!

BUT, IN THOSE DAYS, THEY DIDN'T KNOW ABOUT STATIC ELECTRICITY.

INCIDENTALLY, THE WORD *ELECTRICITY* COMES FROM THE WORD *ELECTRON*, WHICH MEANS AMBER IN GREEK.

electron

HUH!



THE MYSTERIOUS FORCE THAT ATTRACTS TINY OBJECTS TOGETHER CAN NOW BE EXPLAINED WITH ELECTRICITY.

?



THE TRUE NATURE OF ELECTRICITY

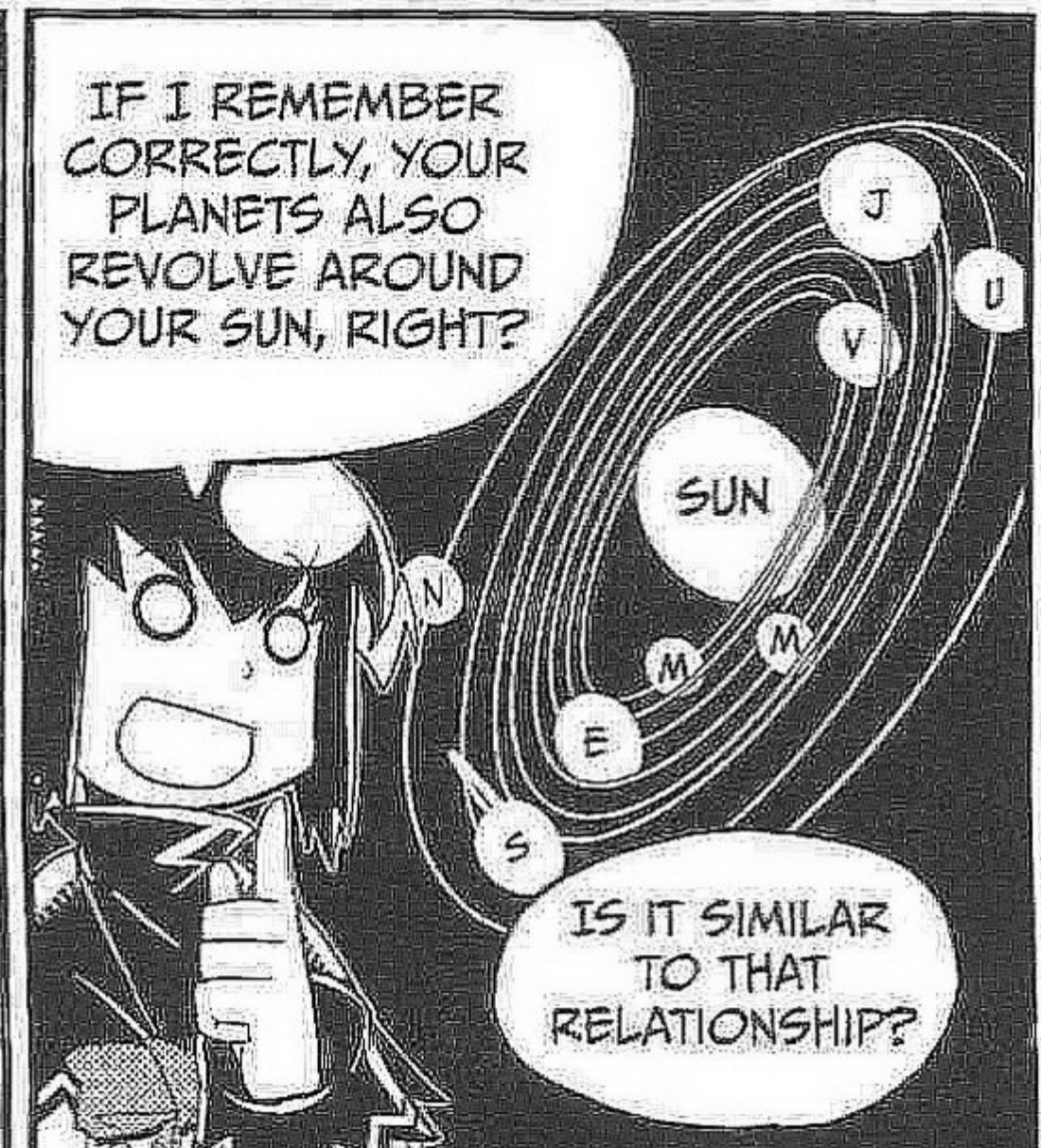
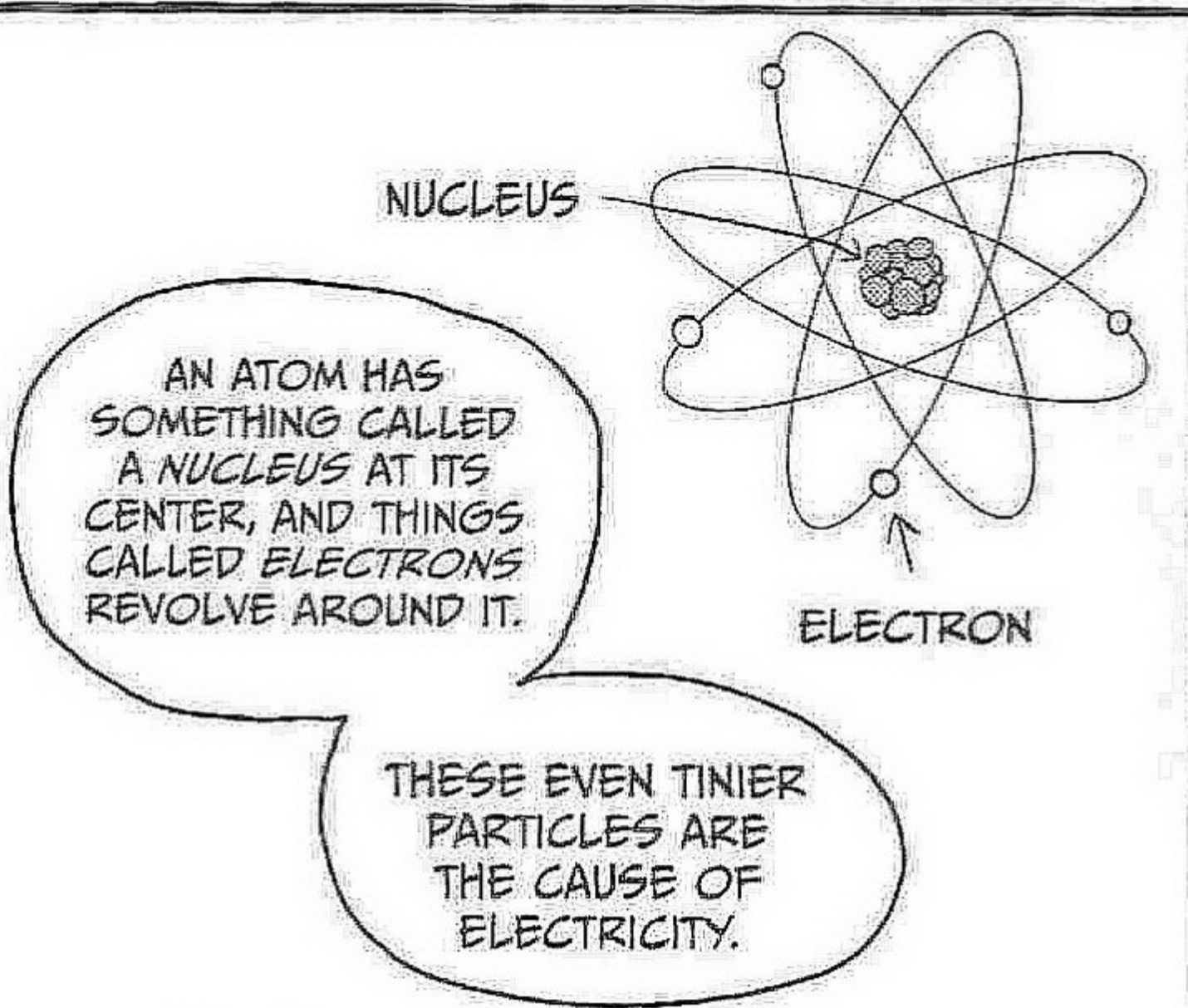
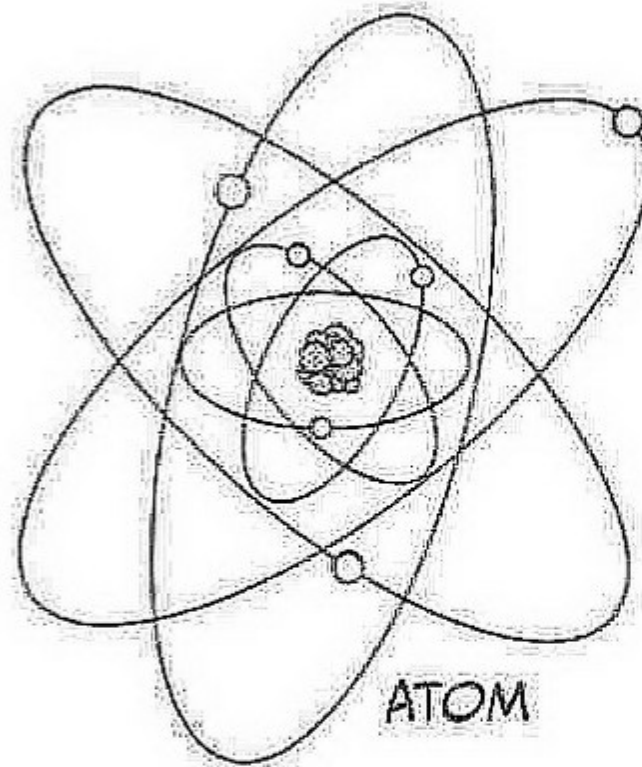
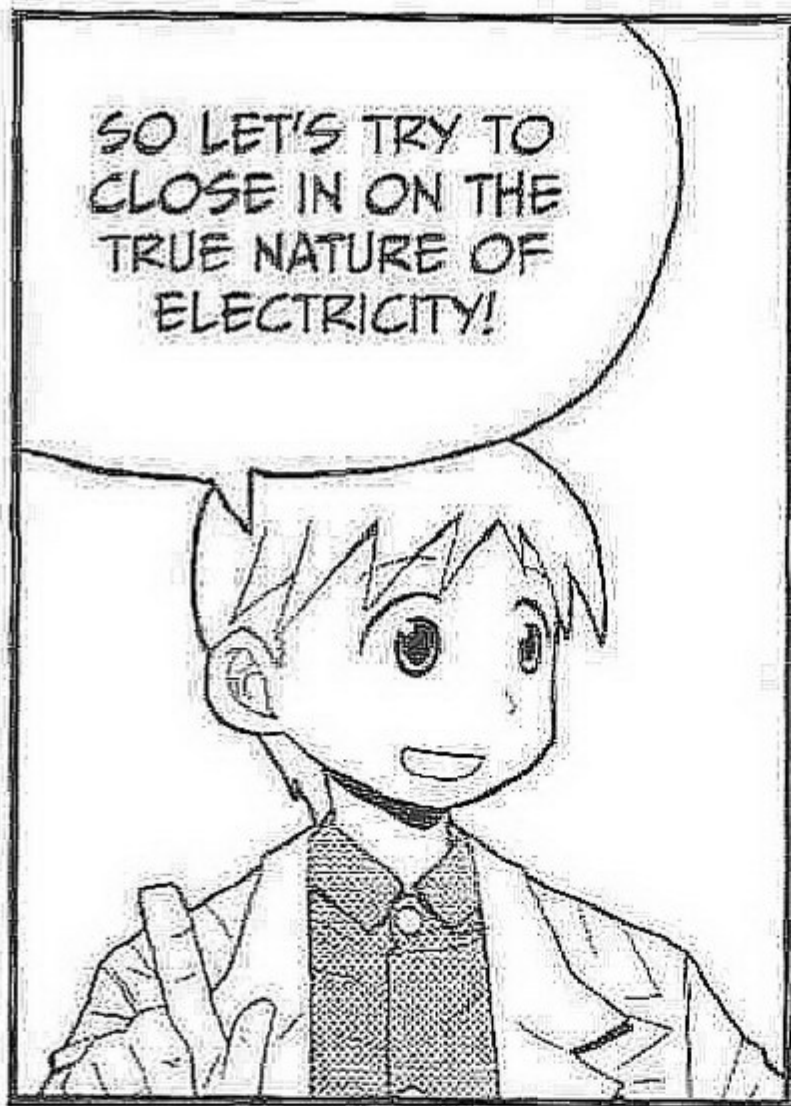

IT IS! THE NUCLEUS, WHICH CORRESPONDS TO THE SUN, CONSISTS OF PROTONS, WHICH HAVE AN ELECTRICALLY POSITIVE PROPERTY, AND NEUTRONS, WHICH HAVE NO ELECTRICAL PROPERTY.

PROTON (+)

NEUTRON (NEUTRAL)

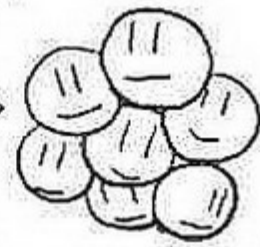

THE ELECTRONS THAT REVOLVE AROUND THE OUTSIDE HAVE A NEGATIVE PROPERTY.

ELECTRON (-)

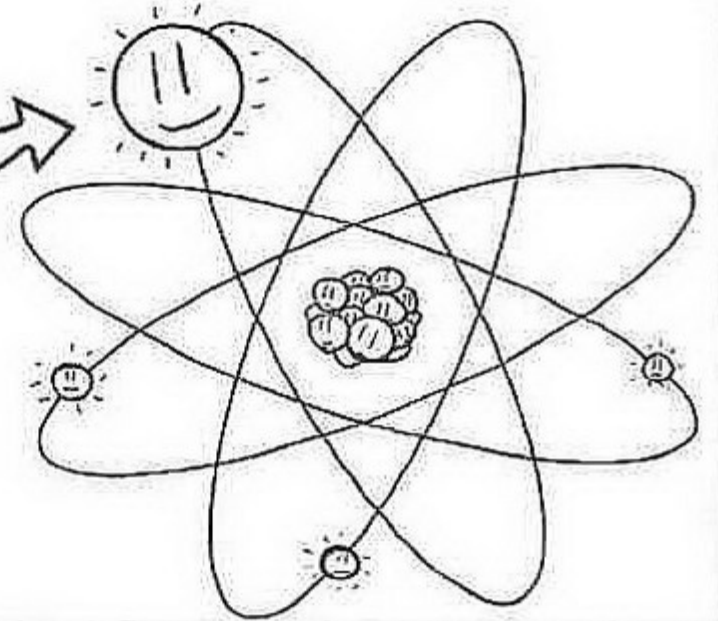

IF AN ATOM CONTAINS BOTH POSITIVES AND NEGATIVES, IS THE ATOM ITSELF POSITIVE OR NEGATIVE?

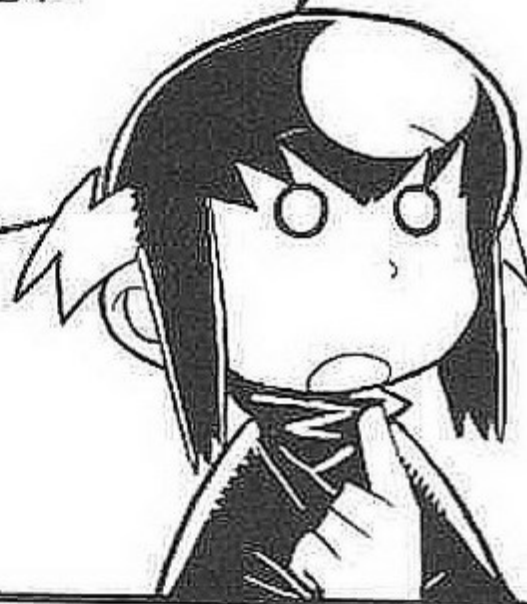

SINCE THE NUMBER OF PROTONS IS USUALLY THE SAME AS THE NUMBER OF ELECTRONS, THE ATOM ITSELF IS ELECTRICALLY NEUTRAL.

NOW, IF EXTERNAL HEAT OR LIGHT IS ADDED TO AN ATOM...

LIGHT

HEAT

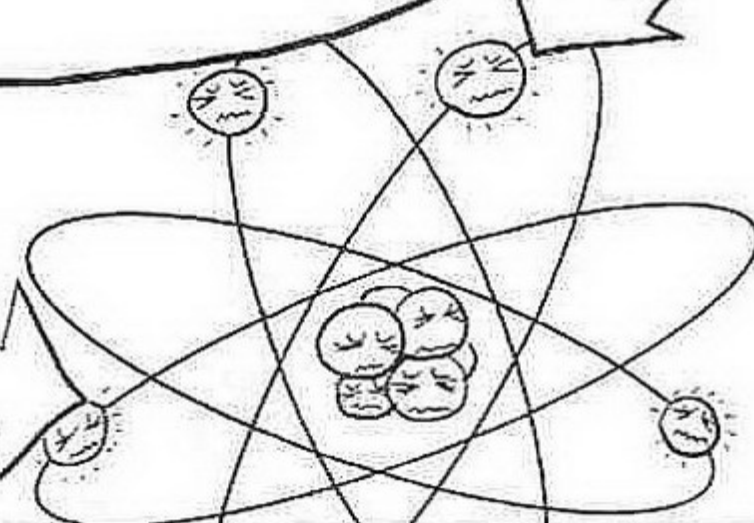

ZIP!

YOW!

AN ELECTRON MAY ESCAPE FROM THE ATOM. THIS IS CALLED A FREE ELECTRON.

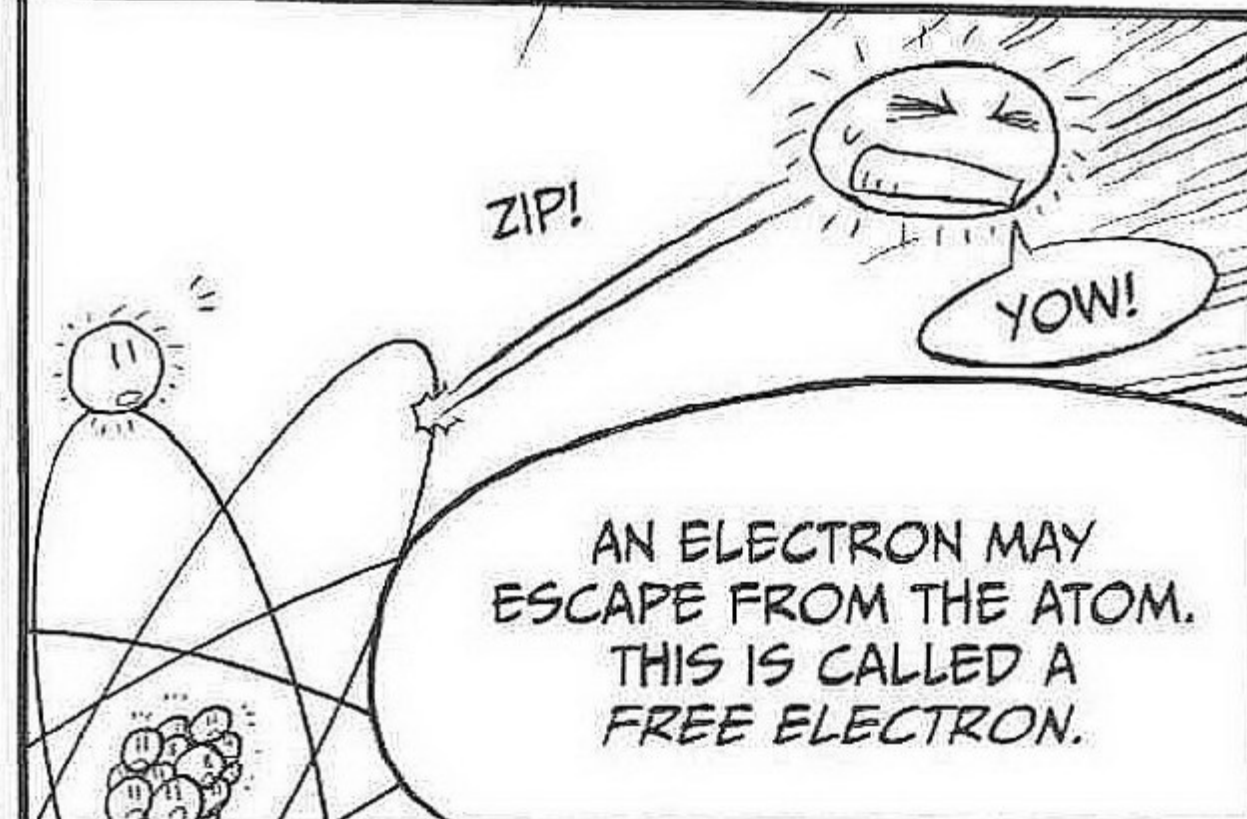

WHAT HAPPENS IF IT ESCAPES?

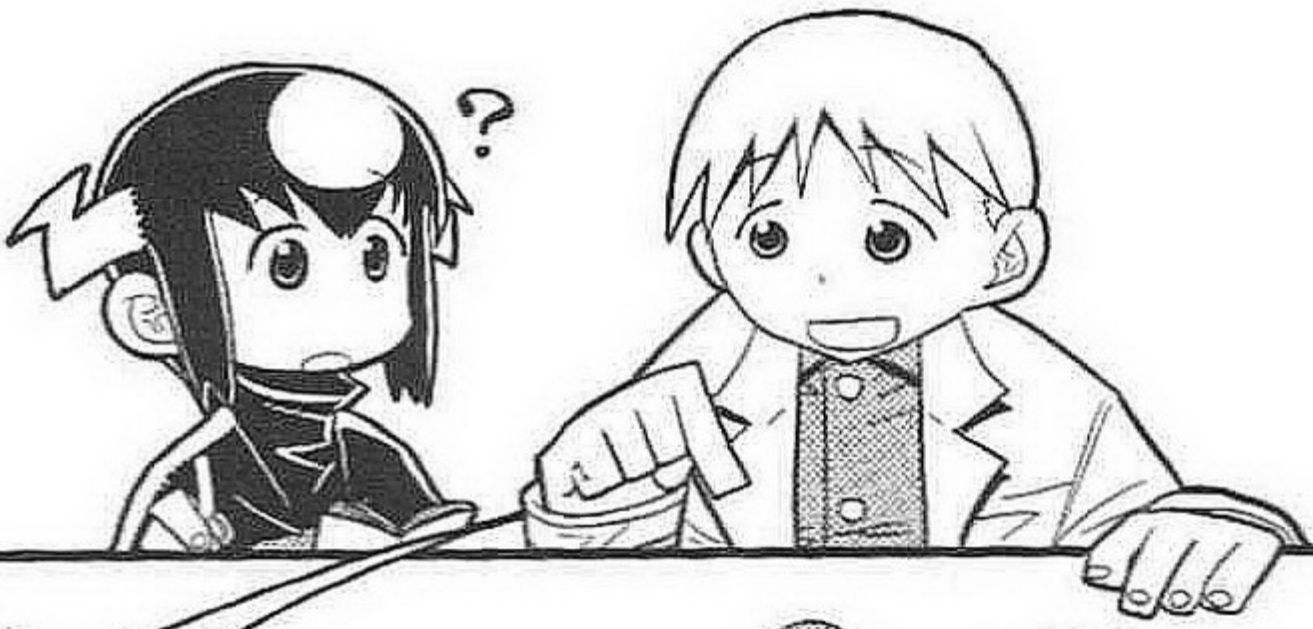

IF AN ELECTRON ESCAPES, THE NEGATIVES ARE REDUCED, AND THE ATOM BECOMES ELECTRICALLY POSITIVE.

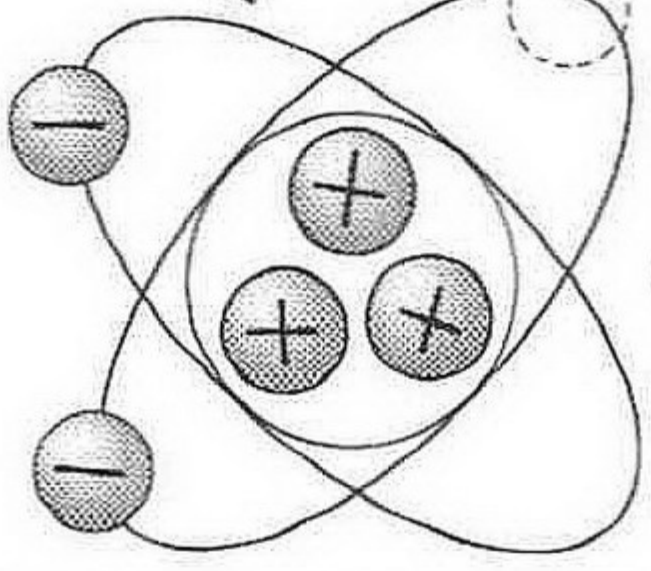

THE NUMBER OF ELECTRONS DECREASES, AND THE ATOM BECOMES ELECTRICALLY POSITIVE.

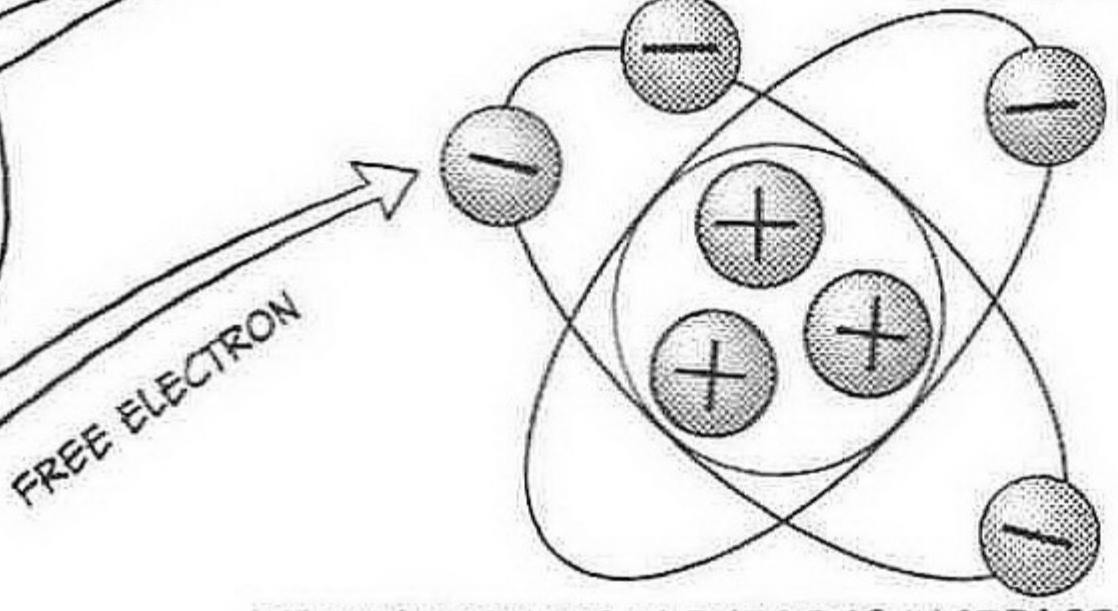

THE NUMBER OF ELECTRONS INCREASES, AND THE ATOM BECOMES ELECTRICALLY NEGATIVE.

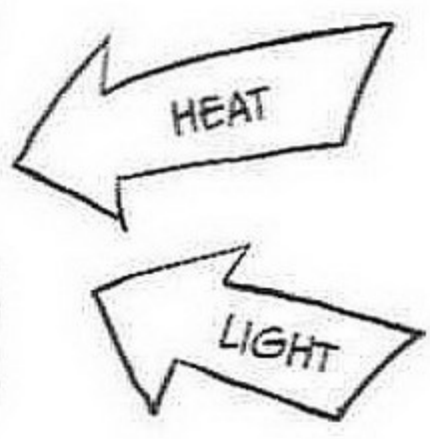

IF AN ESCAPED ELECTRON PLUNGES INTO ANOTHER ATOM, THE NEGATIVES IN THAT ATOM INCREASE, AND IT BECOMES ELECTRICALLY NEGATIVE.



AHA! THE ESCAPED ELECTRON MOVES TO ANOTHER ATOM!

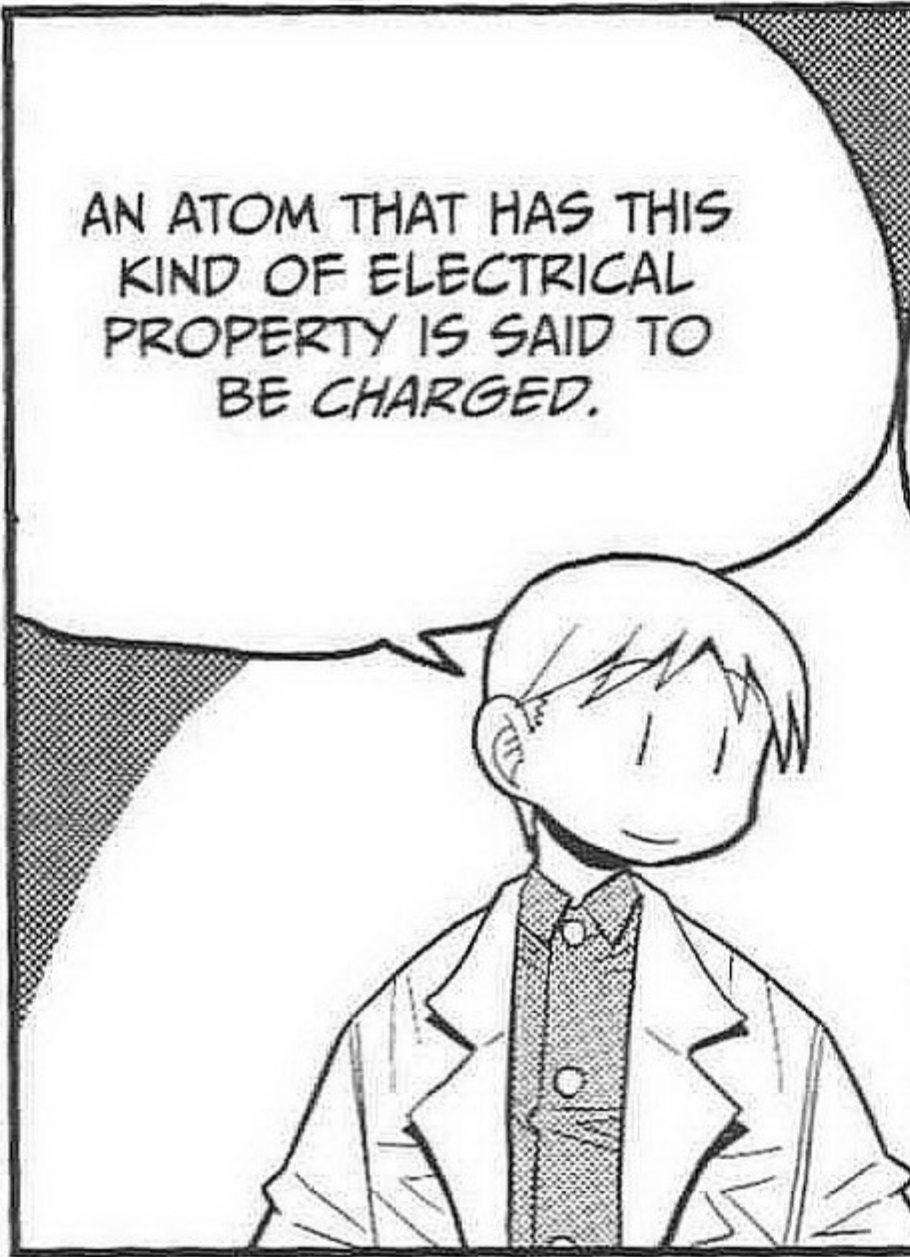

AN ATOM THAT HAS THIS KIND OF ELECTRICAL PROPERTY IS SAID TO BE CHARGED.

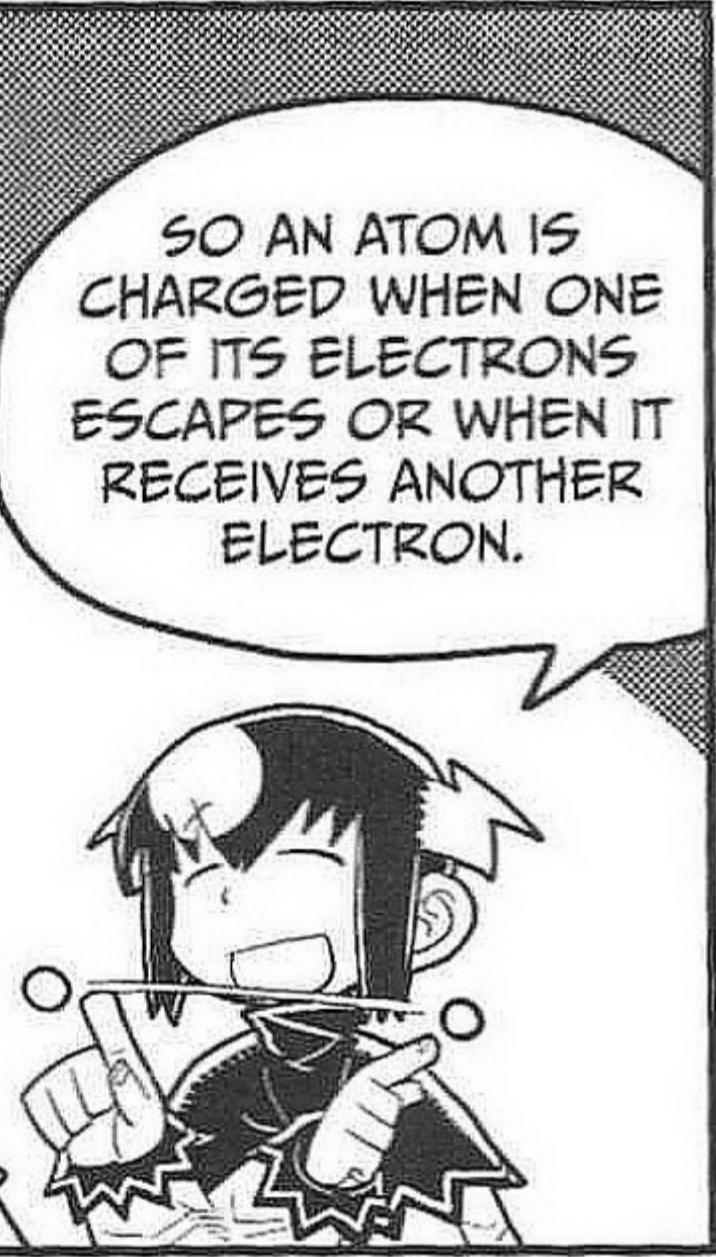

SO AN ATOM IS CHARGED WHEN ONE OF ITS ELECTRONS ESCAPES OR WHEN IT RECEIVES ANOTHER ELECTRON.

CHARGE IS THE POSITIVE OR NEGATIVE ELECTRICAL PROPERTY. A PROTON IS SAID TO HAVE POSITIVE CHARGE AND AN ELECTRON NEGATIVE CHARGE.



CHARGE...??

TWO POSITIVE CHARGES OR TWO NEGATIVE CHARGES REPEL EACH OTHER, WHILE A POSITIVE AND A NEGATIVE ATTRACT EACH OTHER.

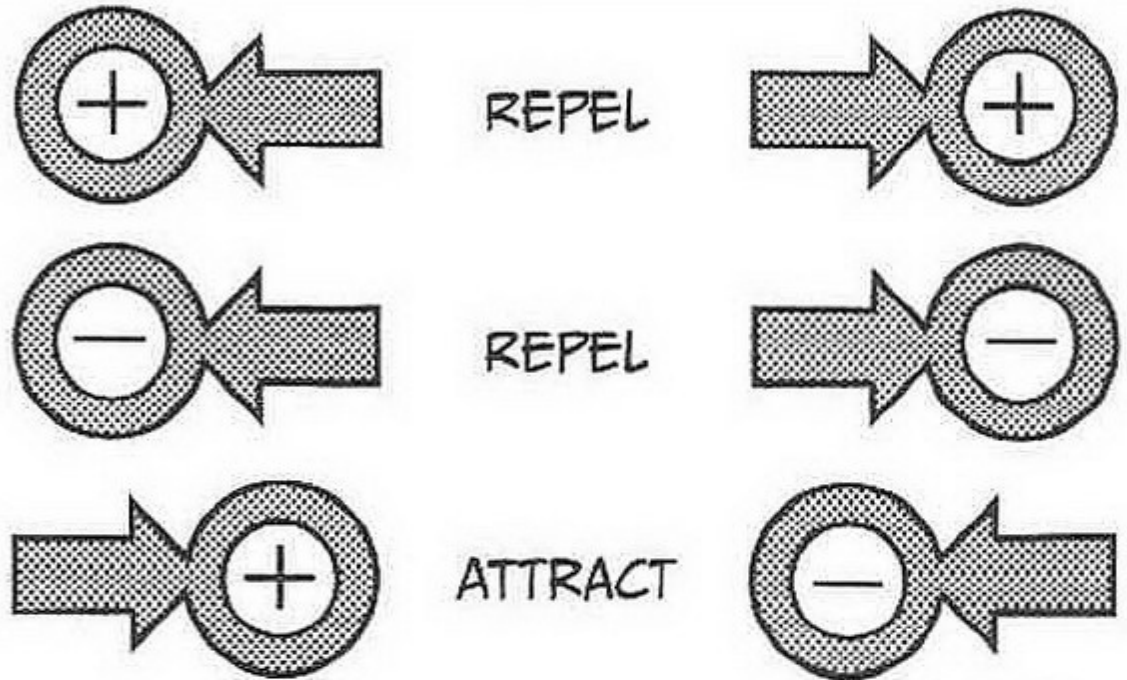

IT'S LIKE THE NORTH AND SOUTH POLES OF A MAGNET, ISN'T IT?



YEP! THIS FORCE IS CALLED THE ELECTROSTATIC FORCE OR COULOMB'S FORCE.



STATIC ELECTRICITY OCCURS WHEN A MATERIAL HAS A POSITIVE OR NEGATIVE ELECTRIC CHARGE THAT IS NOT MOVING.

IF A SUBSTANCE IS POSITIVELY OR NEGATIVELY CHARGED, IT TRIES TO BECOME NEUTRAL AGAIN BY RECEIVING OR LOSING ELECTRONS.

IT TRIES TO GET BACK TO ITS NATURAL STATE, DOESN'T IT?

BY THE WAY, OBJECTS CAN BE CONDUCTORS, THROUGH WHICH ELECTRICITY EASILY FLOWS (LIKE METAL)...

...INSULATORS, THROUGH WHICH ELECTRICITY HAS DIFFICULTY FLOWING (LIKE GLASS OR RUBBER)...

...AND SEMICONDUCTORS, WHICH ARE MIDWAY BETWEEN CONDUCTORS AND INSULATORS.

HMMM.

IF THERE IS AN INSULATOR BETWEEN A POSITIVE AND A NEGATIVE CHARGE, THE ELECTRONS CANNOT MOVE.

INSULATOR

絶縁体

BECAUSE THE ELECTRICITY HAS DIFFICULTY FLOWING, RIGHT?

IF OBJECTS HAVING A CHARGE ARE CONNECTED BY A CONDUCTOR LIKE A COPPER WIRE...



TWANG!

...THE NEGATIVE ELECTRONS MOVE TO THE POSITIVE SIDE.

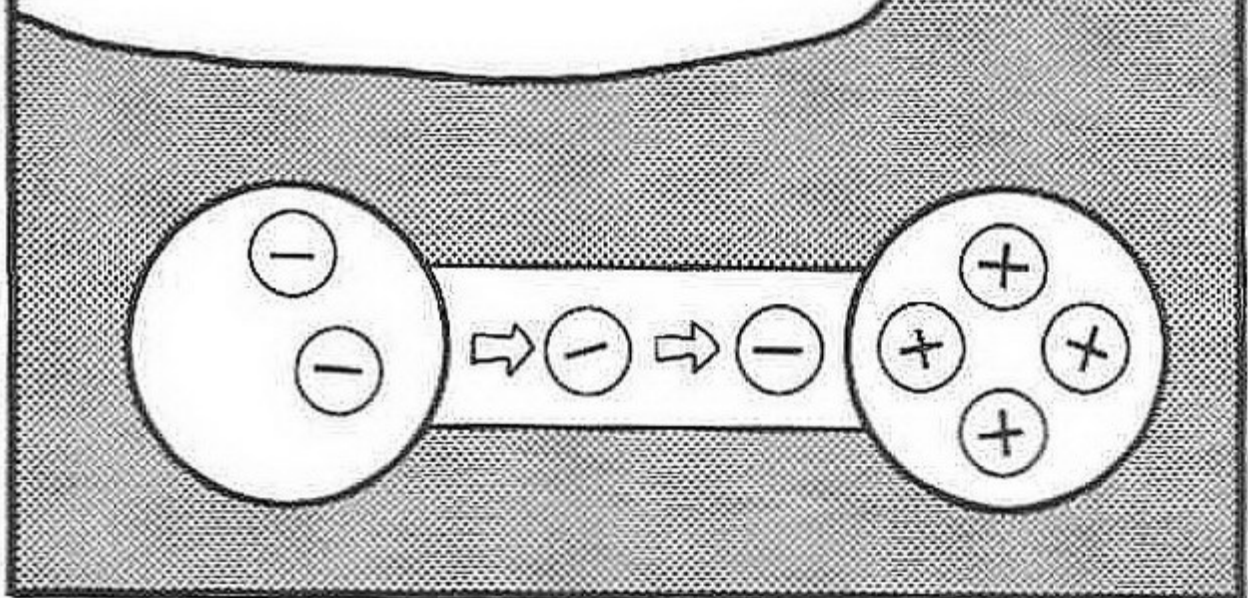

THEN THE POSITIVES AND NEGATIVES UNITE TO CANCEL EACH OTHER OUT, AND THE CHARGED STATE NO LONGER EXISTS.

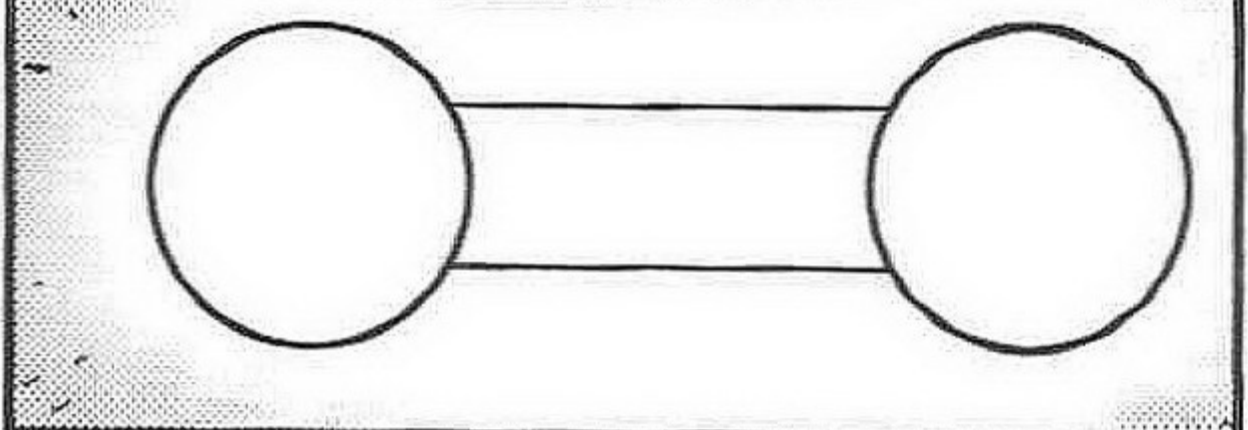

THIS PHENOMENON IS CALLED ELECTRICAL DISCHARGE.



HMMM.

ELECTRICAL DISCHARGE ALSO OCCURS IN THE AIR OR IN A VACUUM.



A DISCHARGE CAN EVEN OCCUR IN THE AIR?

THIS IS WHAT LIGHTNING IS!
LIGHTNING OCCURS WHEN TINY
WATER DROPLETS IN CLOUDS
RUB AGAINST EACH OTHER, AND
THE STATIC ELECTRICITY THAT
WAS PRODUCED DISCHARGES
TO THE GROUND.

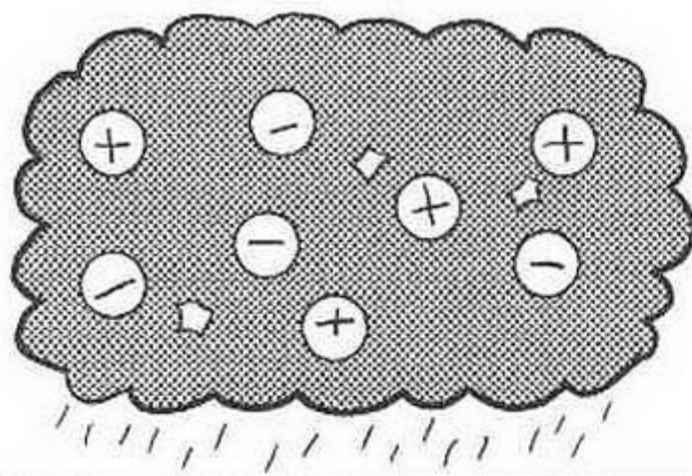

HAIL AND ICE PARTICLES IN
CUMULONIMBUS CLOUDS
COLLIDE WITH EACH OTHER,
AND ELECTRIC CHARGE
ACCUMULATES.

SINCE AIR IS AN
INSULATOR, A
DISCHARGE DOES
NOT OCCUR EASILY.



THEN AN
ENORMOUS
DISCHARGE
OCCURS!

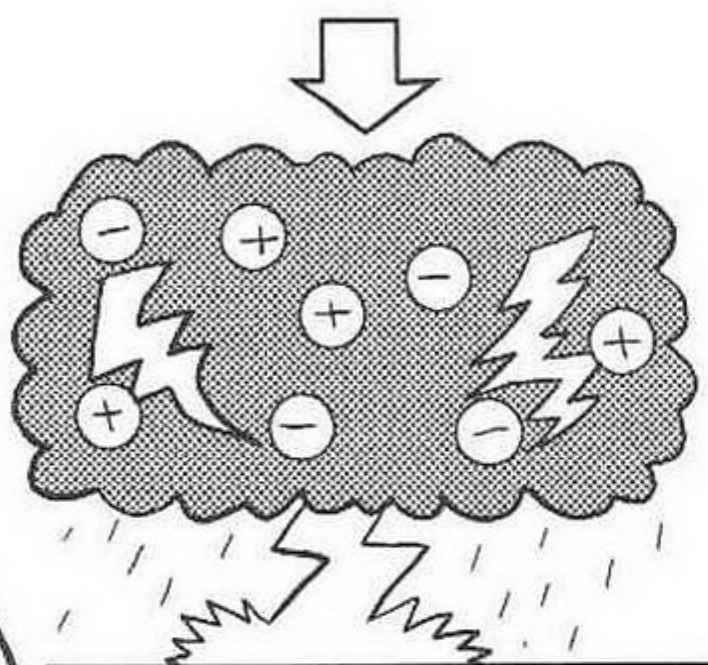

AN ELECTRICAL DISCHARGE
OCCURS, EITHER WITHIN THE
CLOUD ITSELF OR IN THE
FORM OF LIGHTNING TO
THE GROUND.



WHEN A LARGE AMOUNT
OF CHARGE BUILDS UP,
AND THERE IS A
DIFFERENCE IN POTENTIAL
BETWEEN THE POSITIVE
AND NEGATIVE CHARGES...
OR, IN OTHER WORDS,
WHEN THE VOLTAGE
BECOMES VERY HIGH...

THE INSULATION OF THE
AIR SUDDENLY BREAKS
DOWN, AND AN ELECTRICAL
DISCHARGE OCCURS.

THE BREAKDOWN
OF THE INSULATION
CREATES AWESOME
POWER, RIGHT?

IT DOES!
BUT IT HAPPENS
IN AN INSTANT.

THE DISCHARGE OF LIGHTNING IS INSTANTANEOUS. BUT WHEN WE HAVE A CONTINUOUS FLOW OF ELECTRONS, WE HAVE CURRENT.



IN OTHER WORDS, WHEN ELECTRONS ARE CONTINUOUSLY FLOWING, ELECTRICITY IS FLOWING.

BUT ONE THING WE NEED TO BE CAREFUL ABOUT HERE IS THAT THE DIRECTION OF THE CURRENT IS OPPOSITE TO THE DIRECTION OF THE FLOW OF ELECTRONS.



WHEN ELECTRICITY WAS STILL NOT WELL UNDERSTOOD, IT WAS THOUGHT THAT THE FLOW OF POSITIVE CHARGE WAS IN THE SAME DIRECTION AS THE CURRENT.

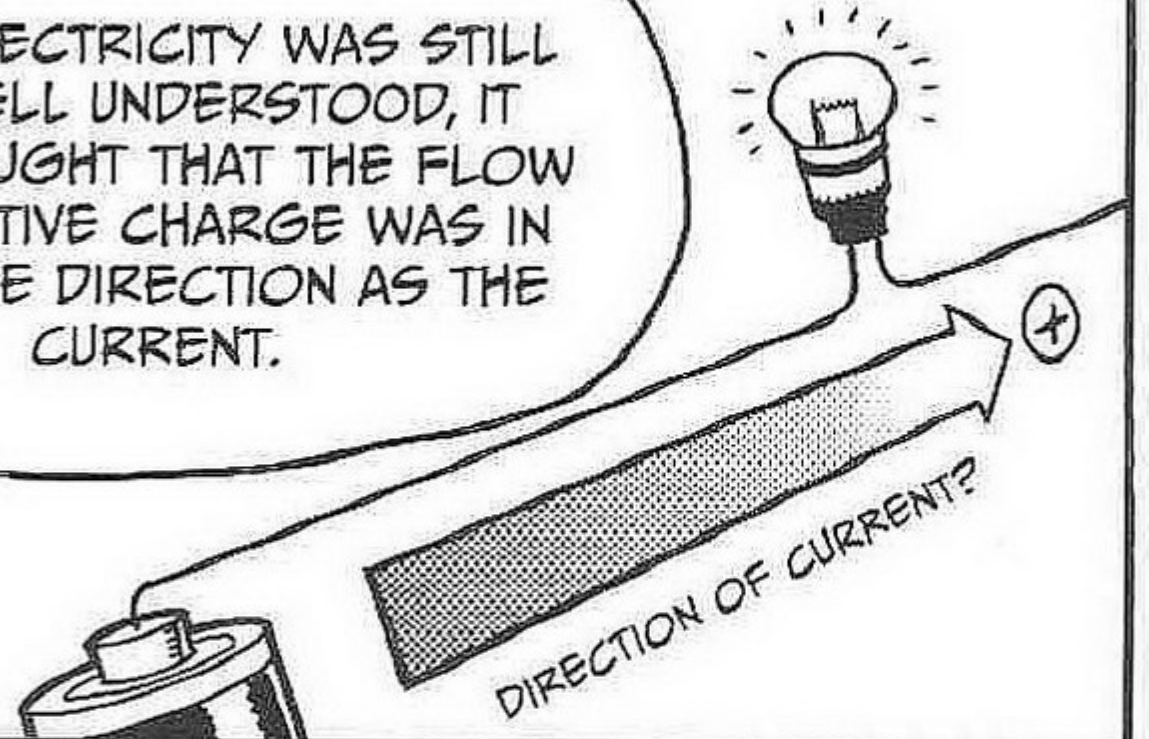

DIRECTION OF CURRENT

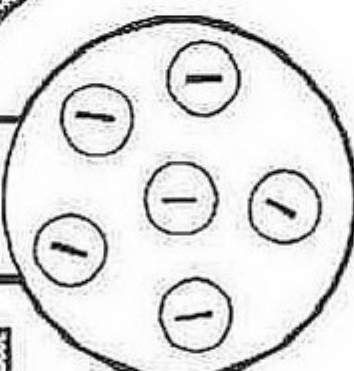
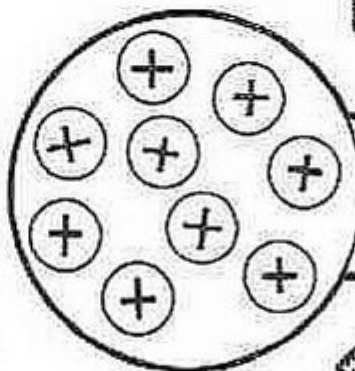
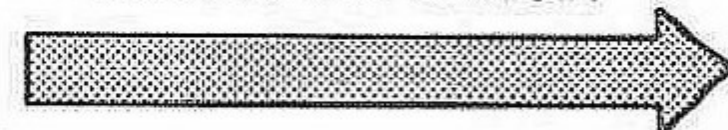

DIRECTION OF ELECTRONS



BUT LATER, AFTER IT WAS KNOWN THAT ELECTRONS HAVE A NEGATIVE CHARGE, IT TURNED OUT THAT THE DIRECTION IN WHICH THE ELECTRONS MOVE IS OPPOSITE TO THE DIRECTION OF THE CURRENT.



ATOMIC STRUCTURE AND CONDUCTIVITY

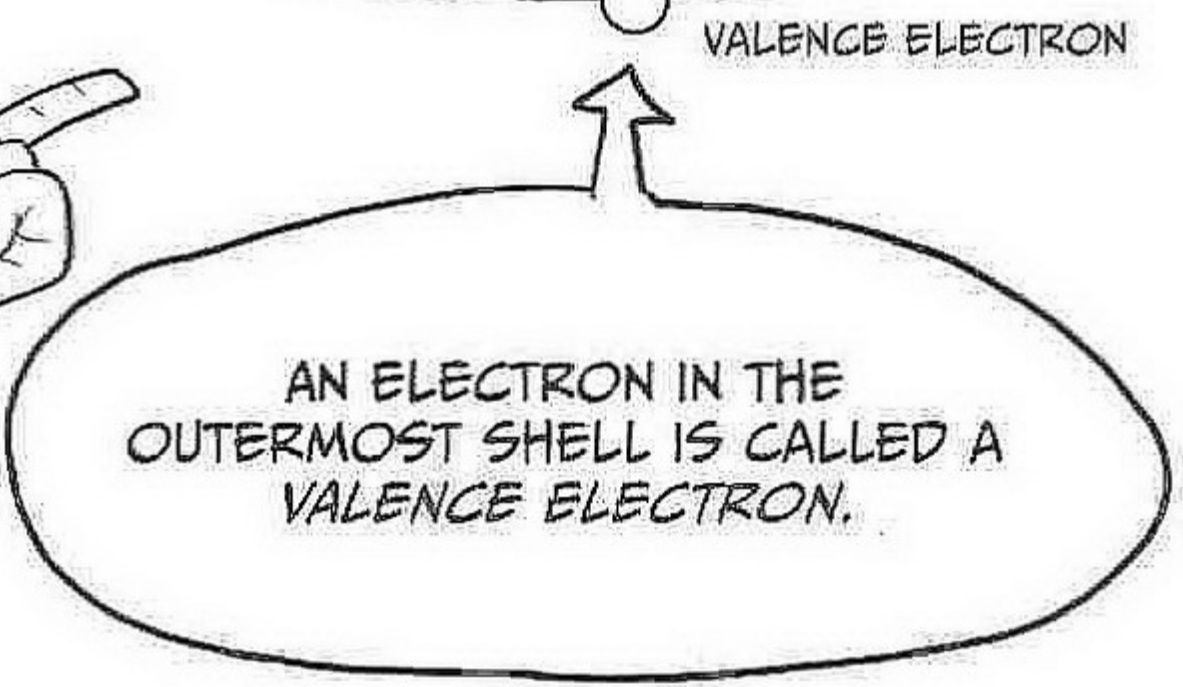
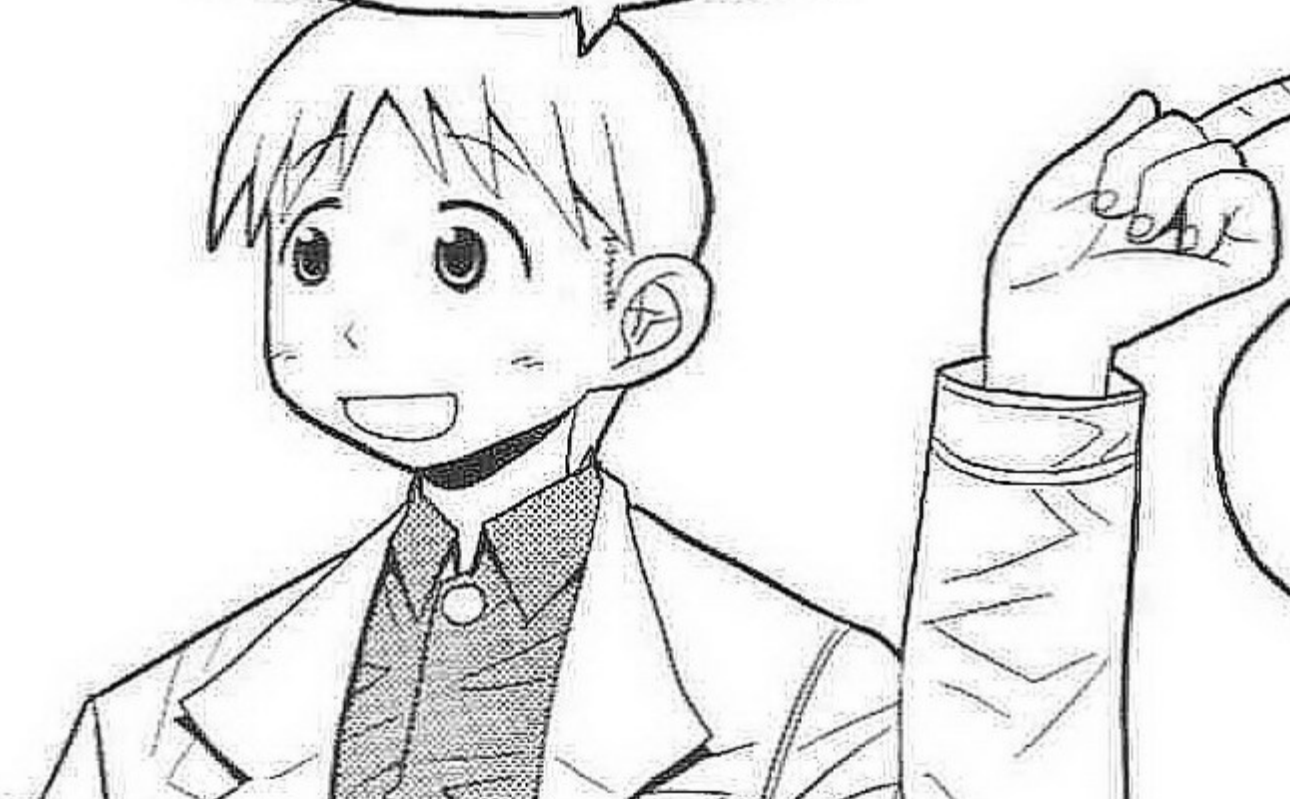
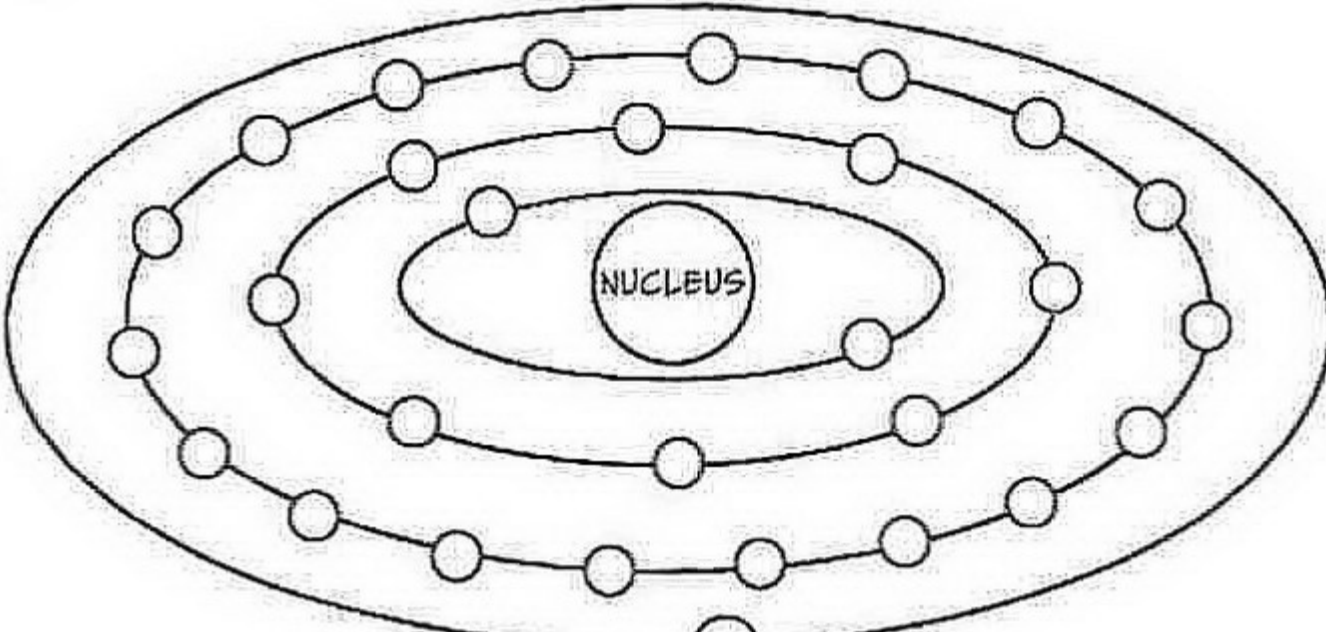
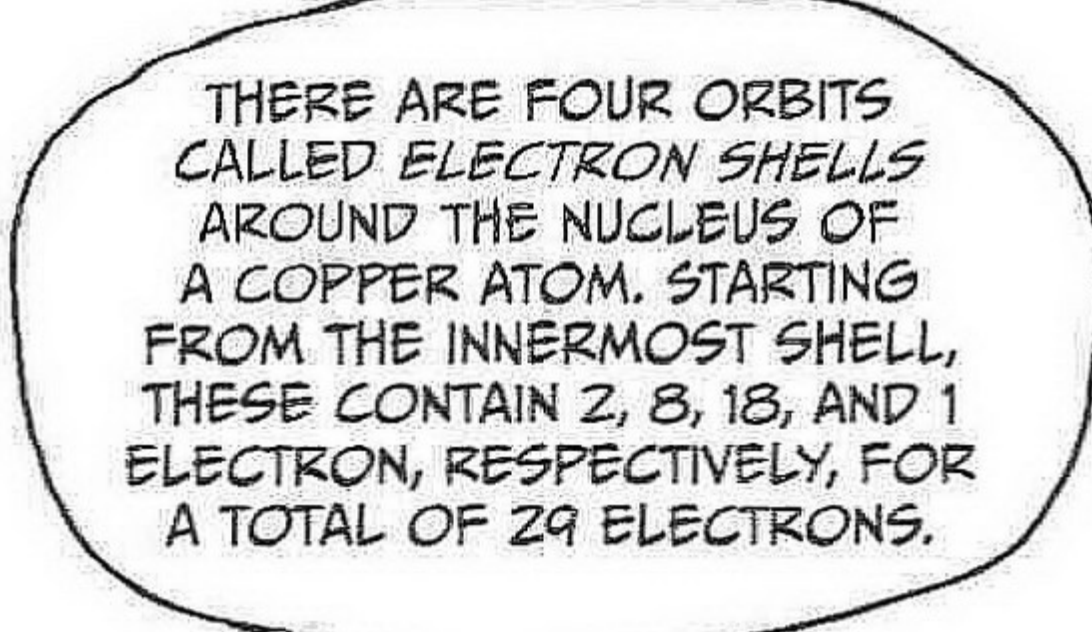
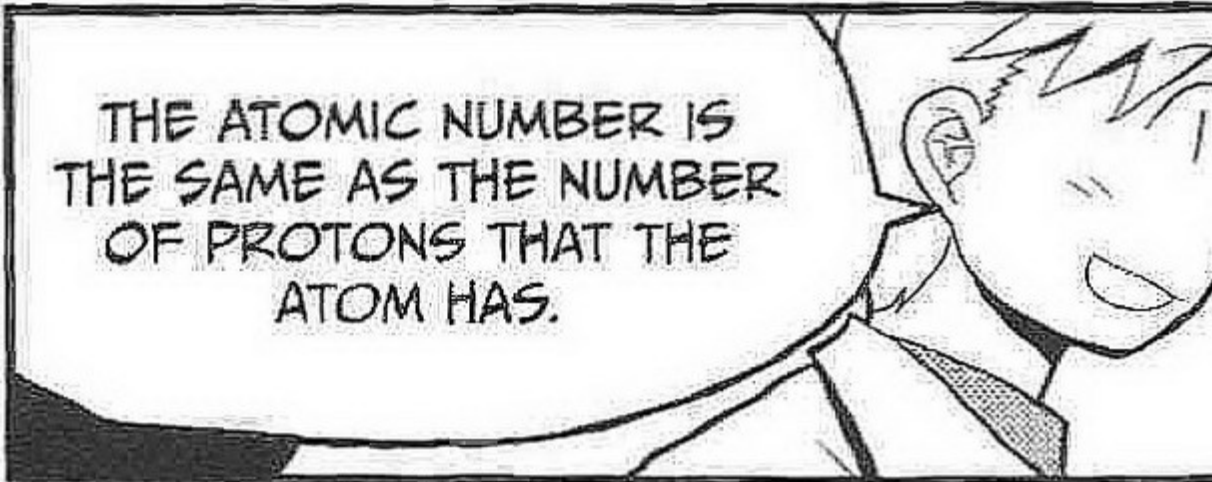
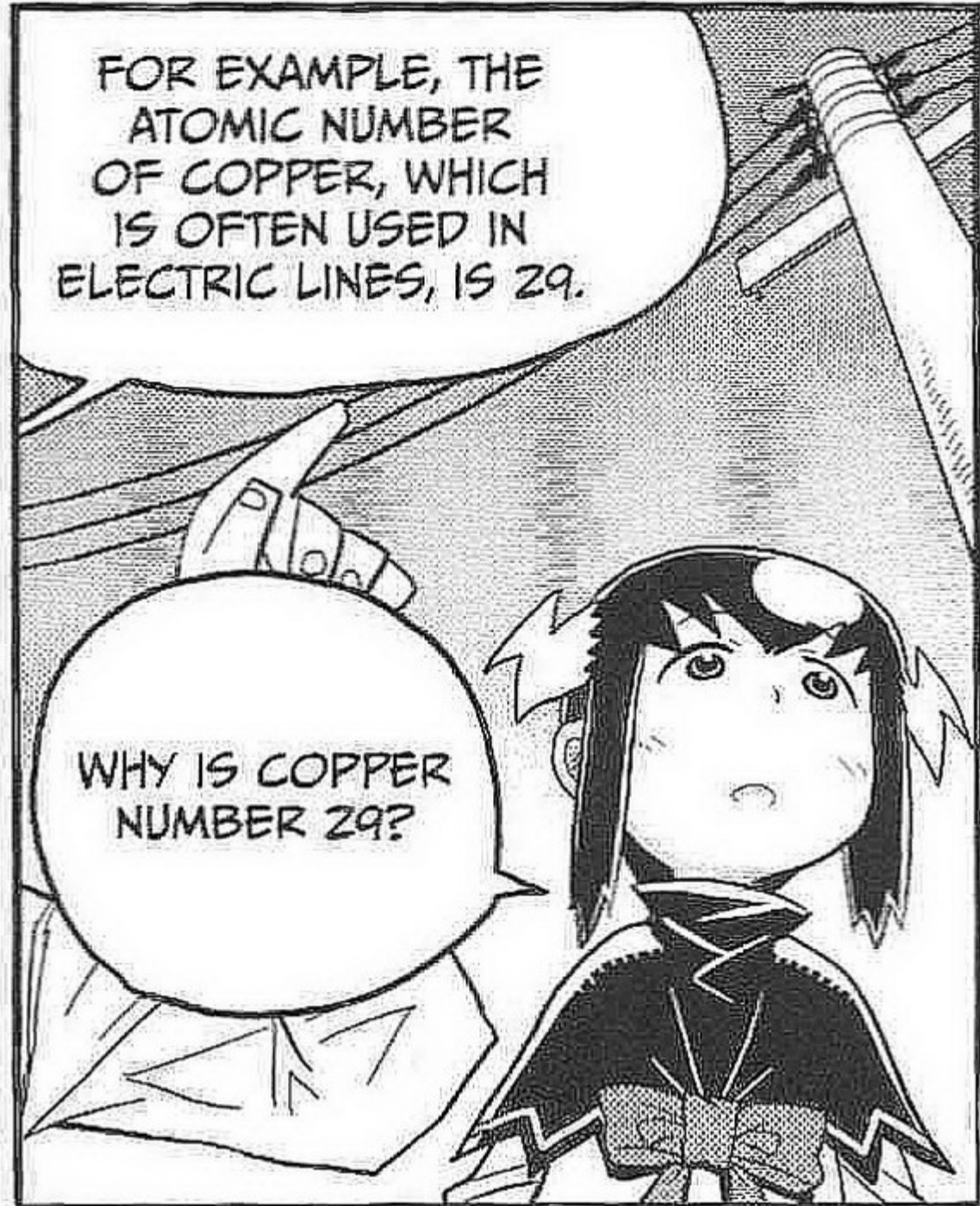

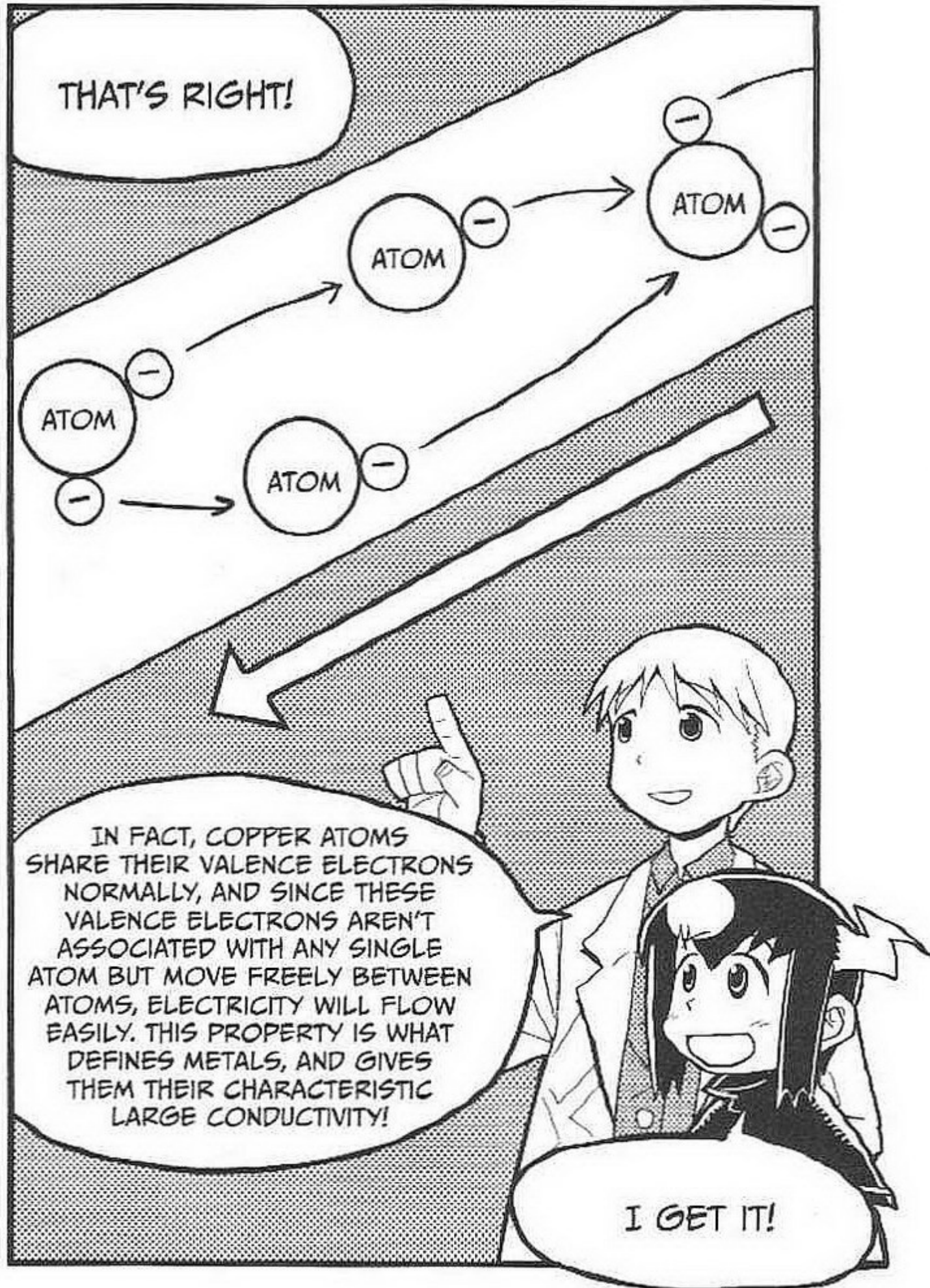
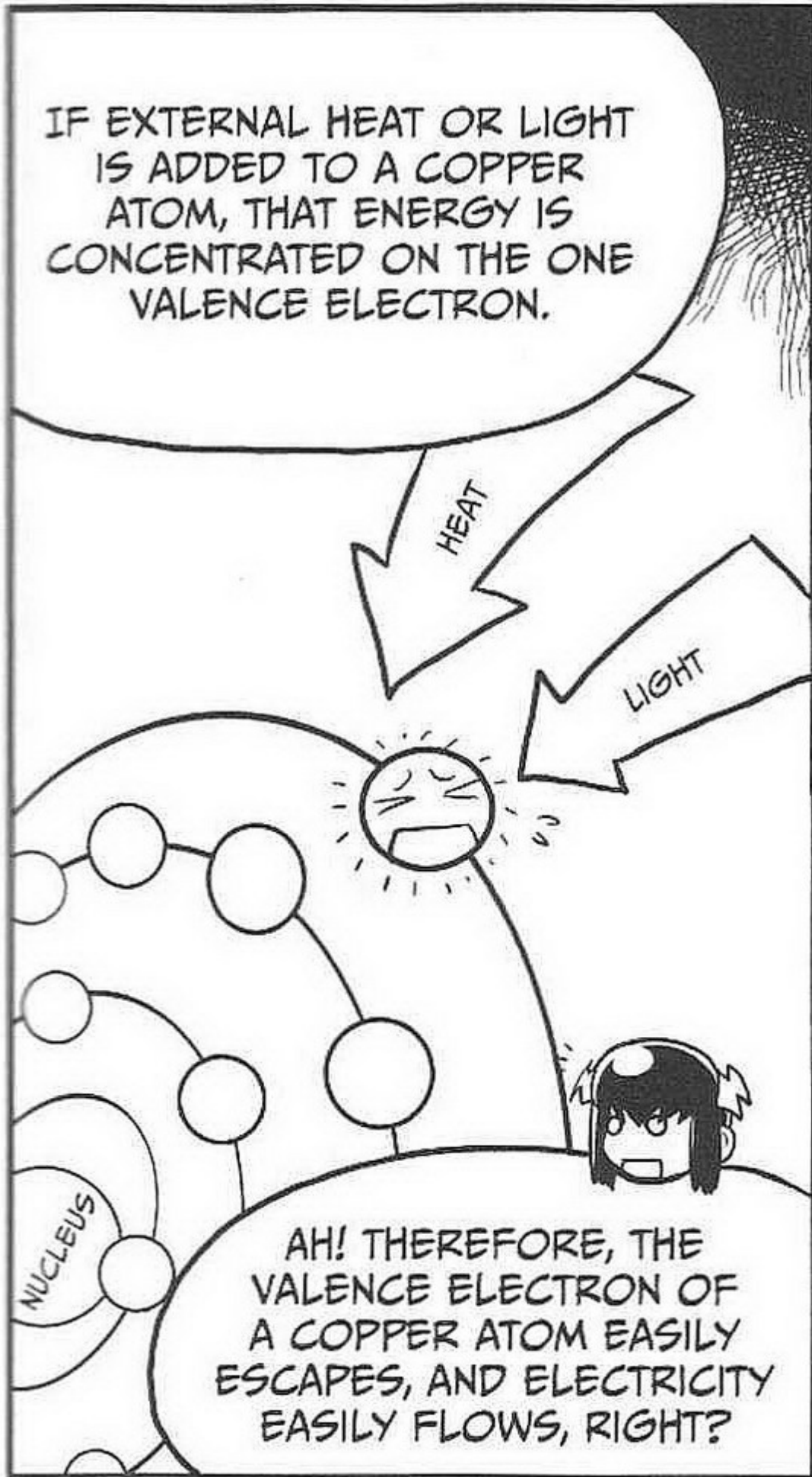

STATIC ELECTRICITY

EARLIER I TOLD YOU THAT STATIC ELECTRICITY OCCURS WHEN AN OBJECT HAS AN ELECTRICALLY POSITIVE OR NEGATIVE CHARGE. STATIC MEANS THAT NOTHING IS MOVING—NO CURRENT FLOWS.

NOW LET'S TALK ABOUT STATIC ELECTRICITY IN A LITTLE MORE DETAIL.

OKAY!

YOU KNOW, WE ALSO HAVE FOUR SEASONS IN ELECTOPIA, AND IN WINTER, IT SEEMS TO CAUSE LITTLE SHOCKS EVERYWHERE... IT'S JUST AWFUL.

ZAP

WITH SWEATERS

ZAP

OW!

OW!

ZAP

WITH DOOR KNOBS

WELL, IN THAT SENSE, STATIC ELECTRICITY IS SOMETHING WE'RE RELATIVELY FAMILIAR WITH. BUT DO YOU KNOW HOW IT IS PRODUCED AND WHAT PROPERTIES IT HAS?

WELL...

UM...IT'S...

THAT'S WHAT I THOUGHT!

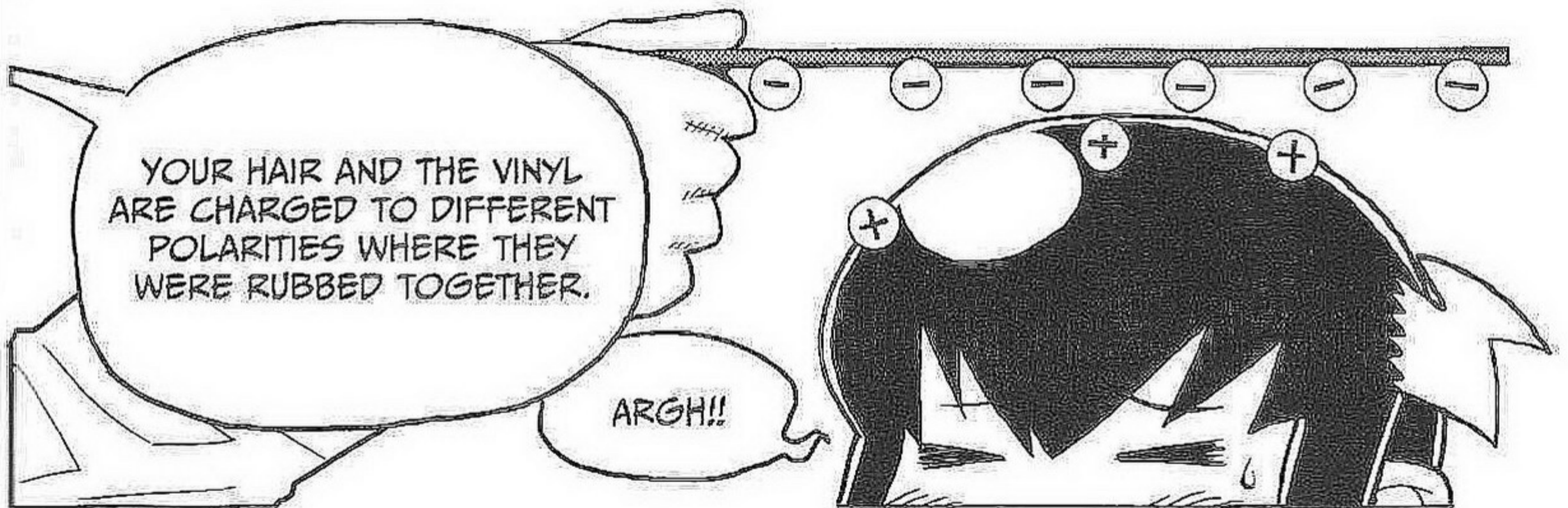
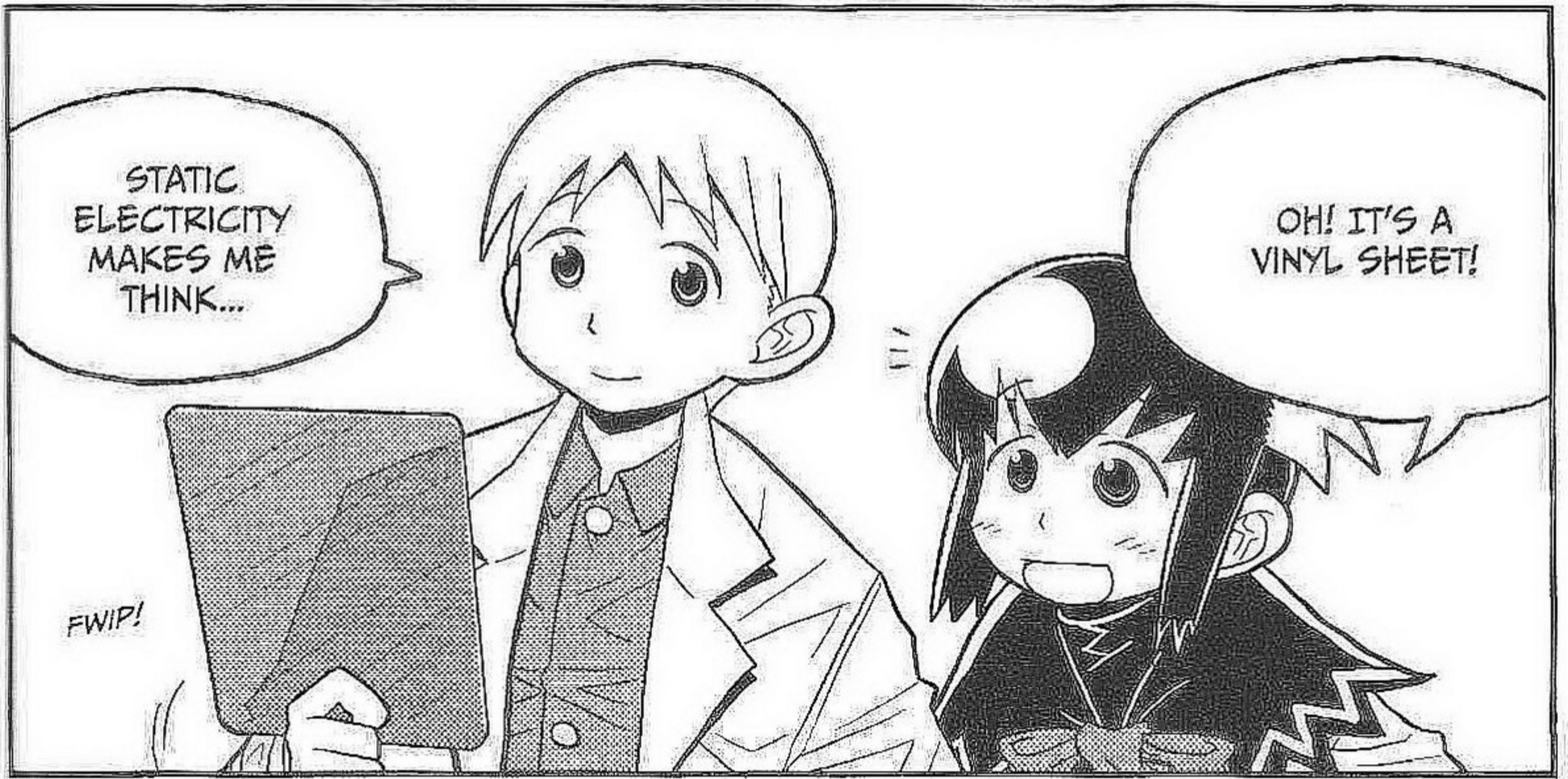

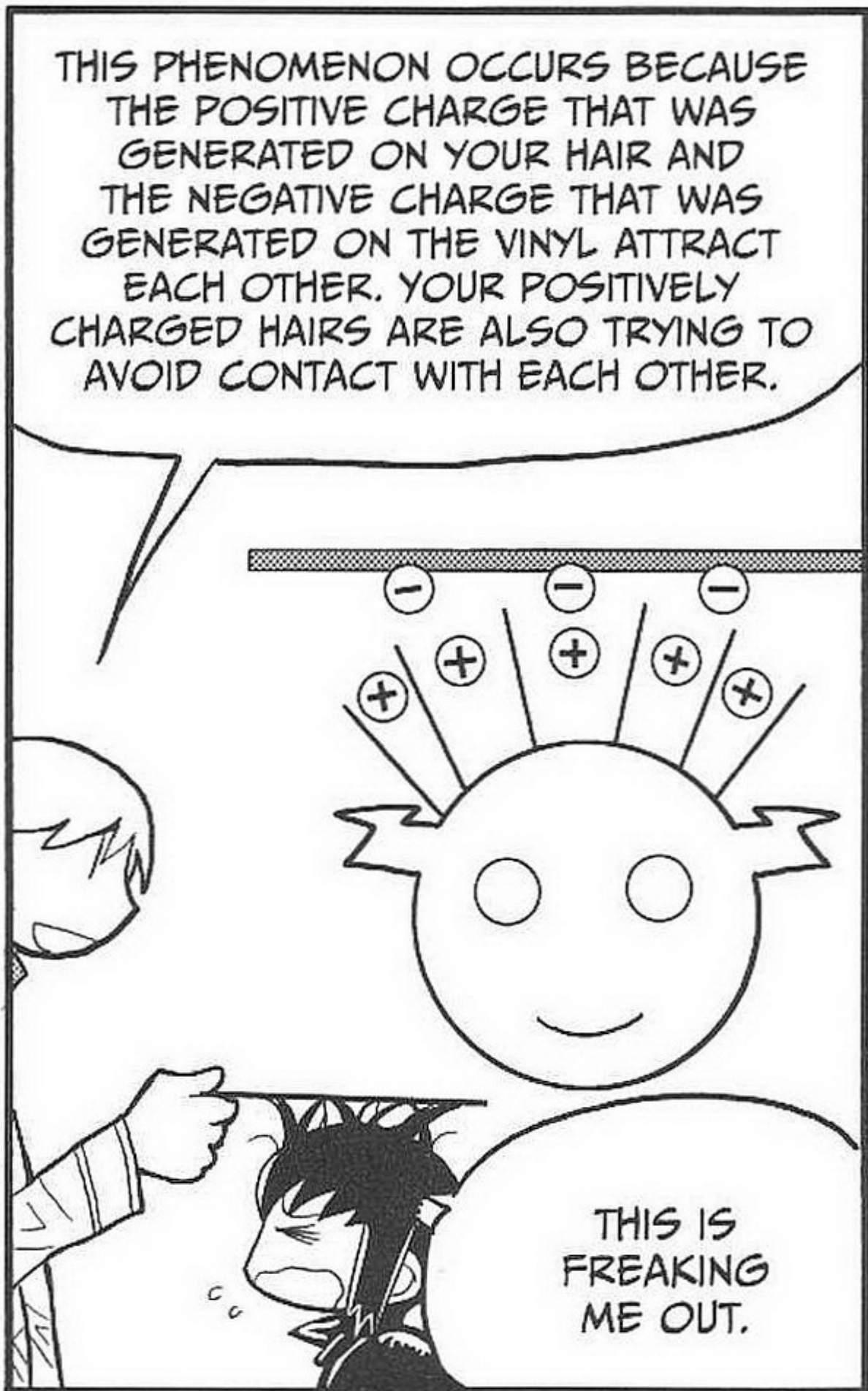

STATIC ELECTRICITY IS GENERATED BY THE CONTACT OR RUBBING OF TWO OBJECTS LIKE THIS.

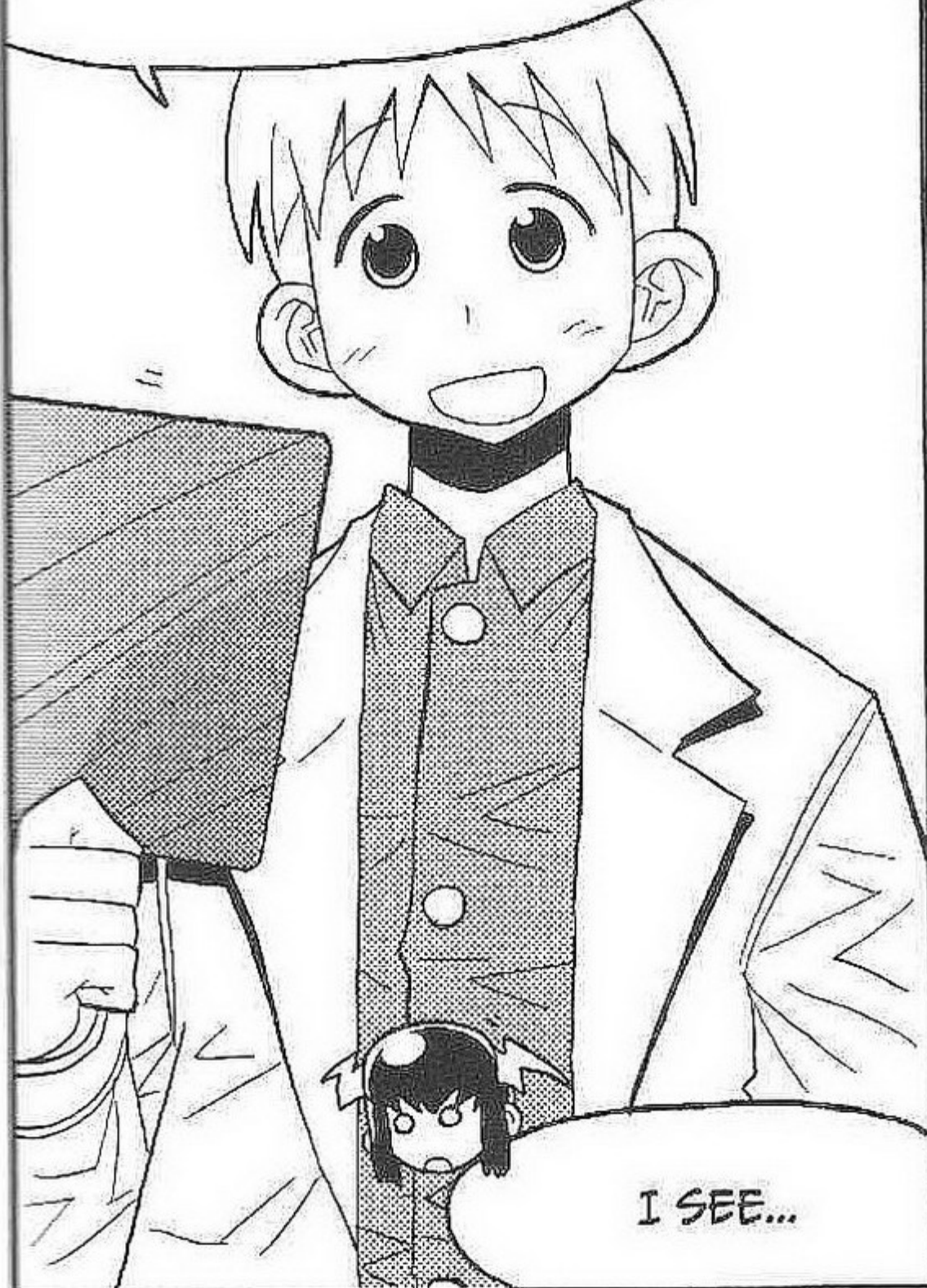

IF I BRING THE CHARGED VINYL TO MY HEAD...



BRINGING THE CHARGED VINYL TO MY HAIR CAUSES CHARGE TO BE REDISTRIBUTED IN MY BODY - THE NEGATIVE CHARGE IN THE VINYL PUSHES ELECTRONS AWAY IN MY HAIR, GIVING IT A POSITIVE CHARGE. NOTE THAT THE OVERALL CHARGE IN MY BODY IS STILL NEUTRAL, AS THERE HAS BEEN NO EXCHANGE OF CHARGE BETWEEN ME AND THE VINYL.

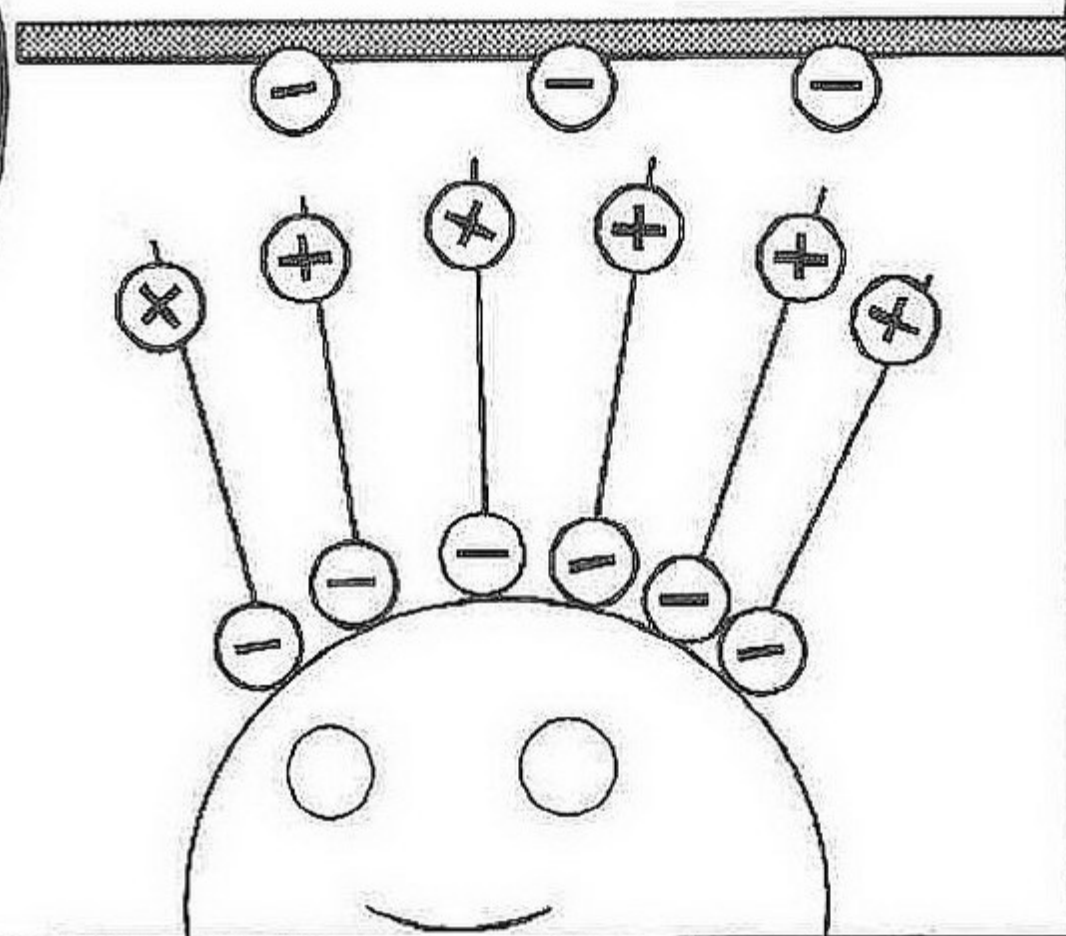

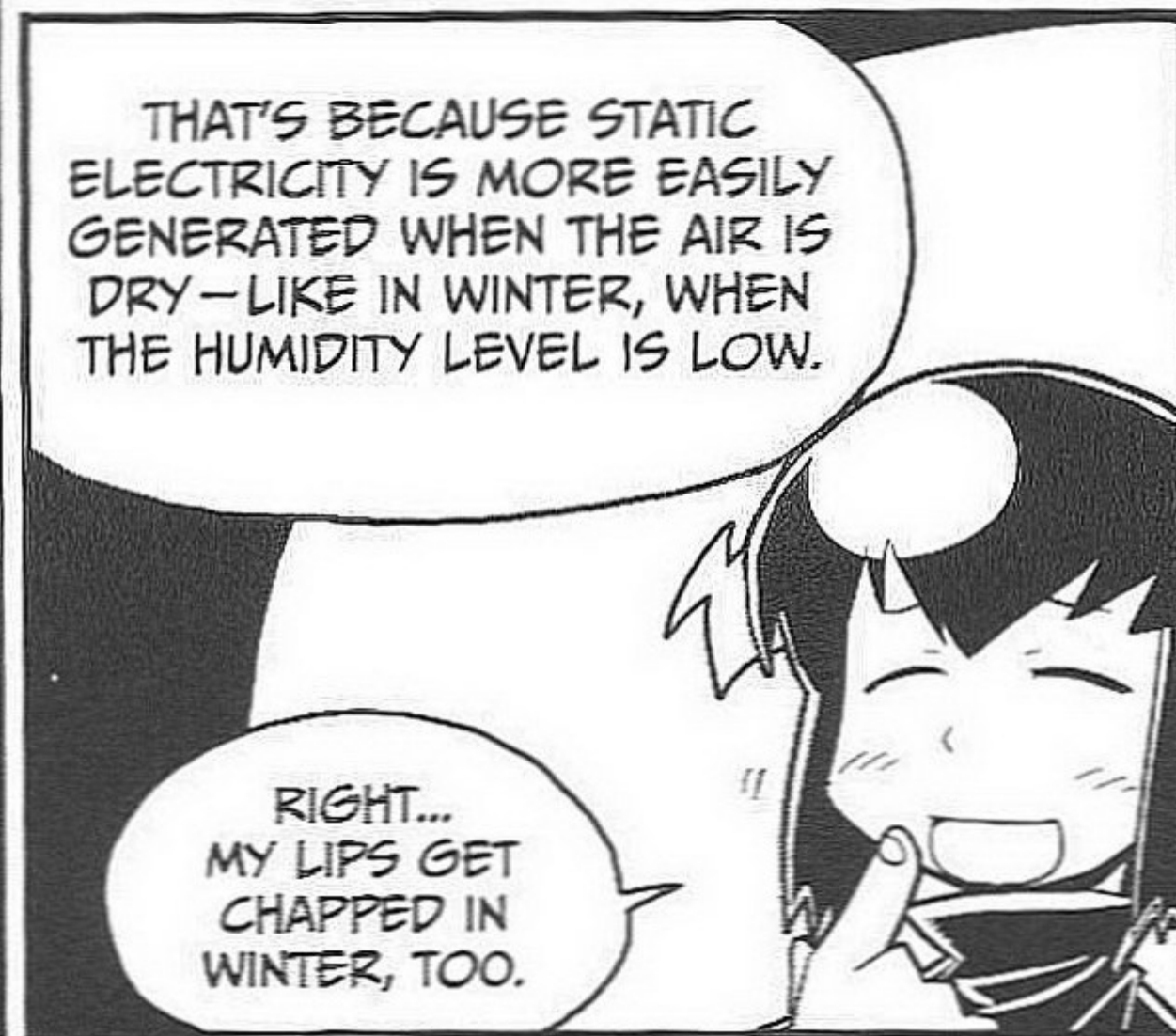

ALSO, SOME CLOTHES BECOME CHARGED EASILY, WHILE OTHERS DO NOT.

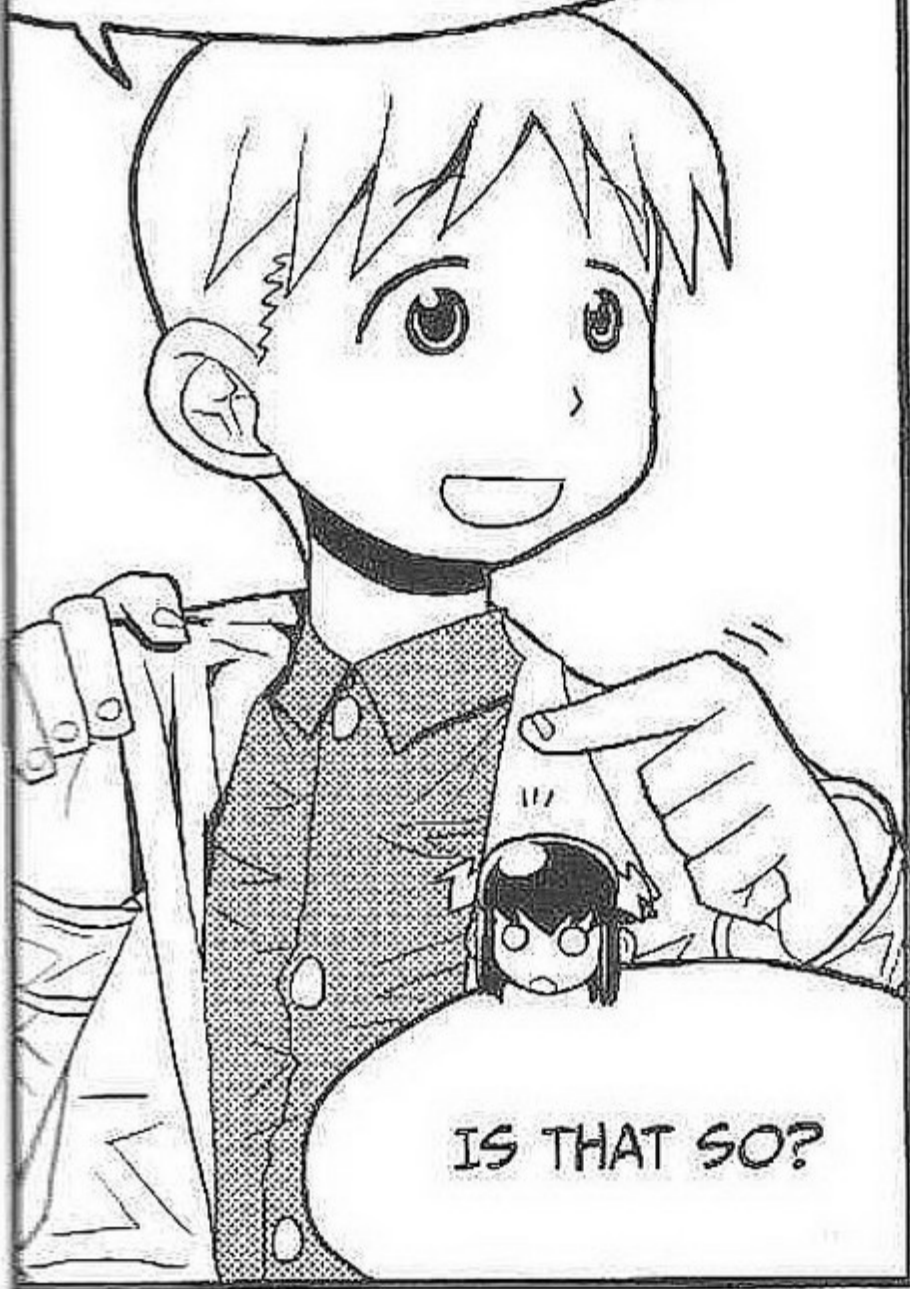

IS THAT SO?

FOR EXAMPLE, SILK HAS GOOD WATER ABSORBENCY AND CONTAINS MUCH MORE MOISTURE THAN SYNTHETIC FIBERS DO. THEREFORE, IT CAN REDUCE THE OCCURRENCE OF STATIC ELECTRICITY.



HUH!

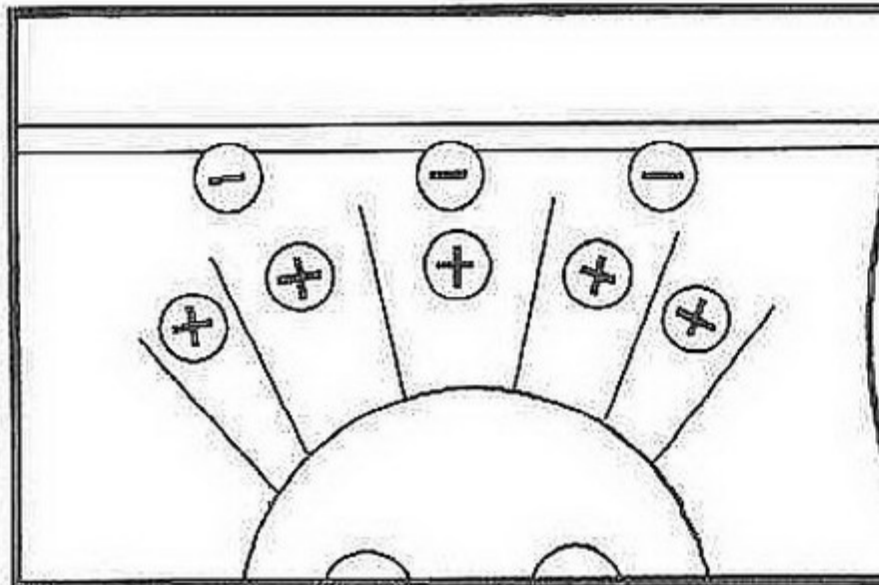

WHEN WE RUBBED VINYL AND HAIR TOGETHER, A NEGATIVE CHARGE WAS GENERATED ON THE VINYL AND A POSITIVE CHARGE ON THE HAIR.

HOWEVER, THE POLARITY OF THE CHARGES THAT ARE GENERATED DIFFERS ACCORDING TO THE MATERIALS THAT ARE RUBBED TOGETHER.

THIS IS CALLED THE TRIBOELECTRIC SERIES.

TRIBOELECTRIC SERIES

-
- HUMAN SKIN
 - GLASS
 - HUMAN HAIR
 - NYLON
 - WOOL
 - SILK
 - PAPER
 - COTTON
 - STEEL
 - WOOD
 - RUBBER
 - COPPER
 - POLYESTER
 - POLYETHYLENE
 - VINYL (PVC)

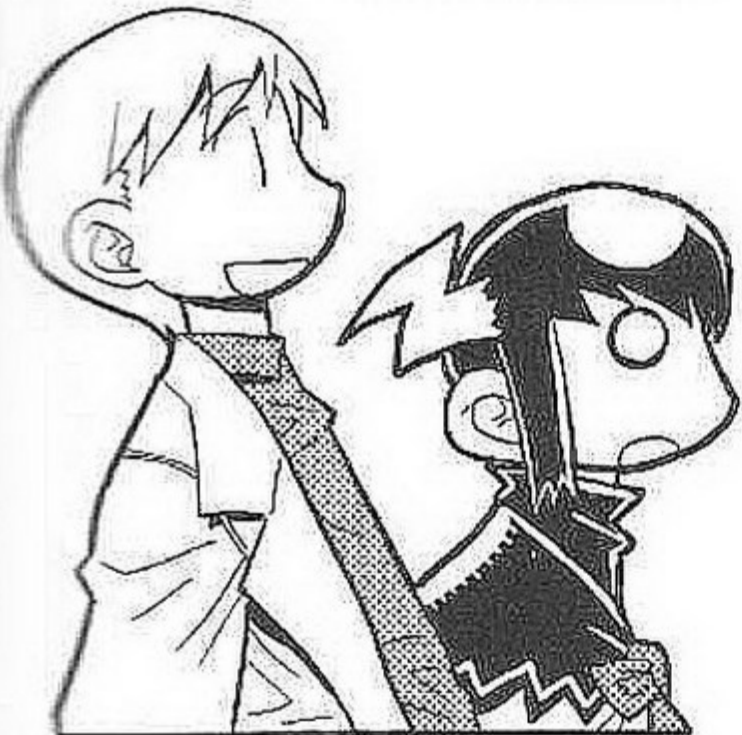

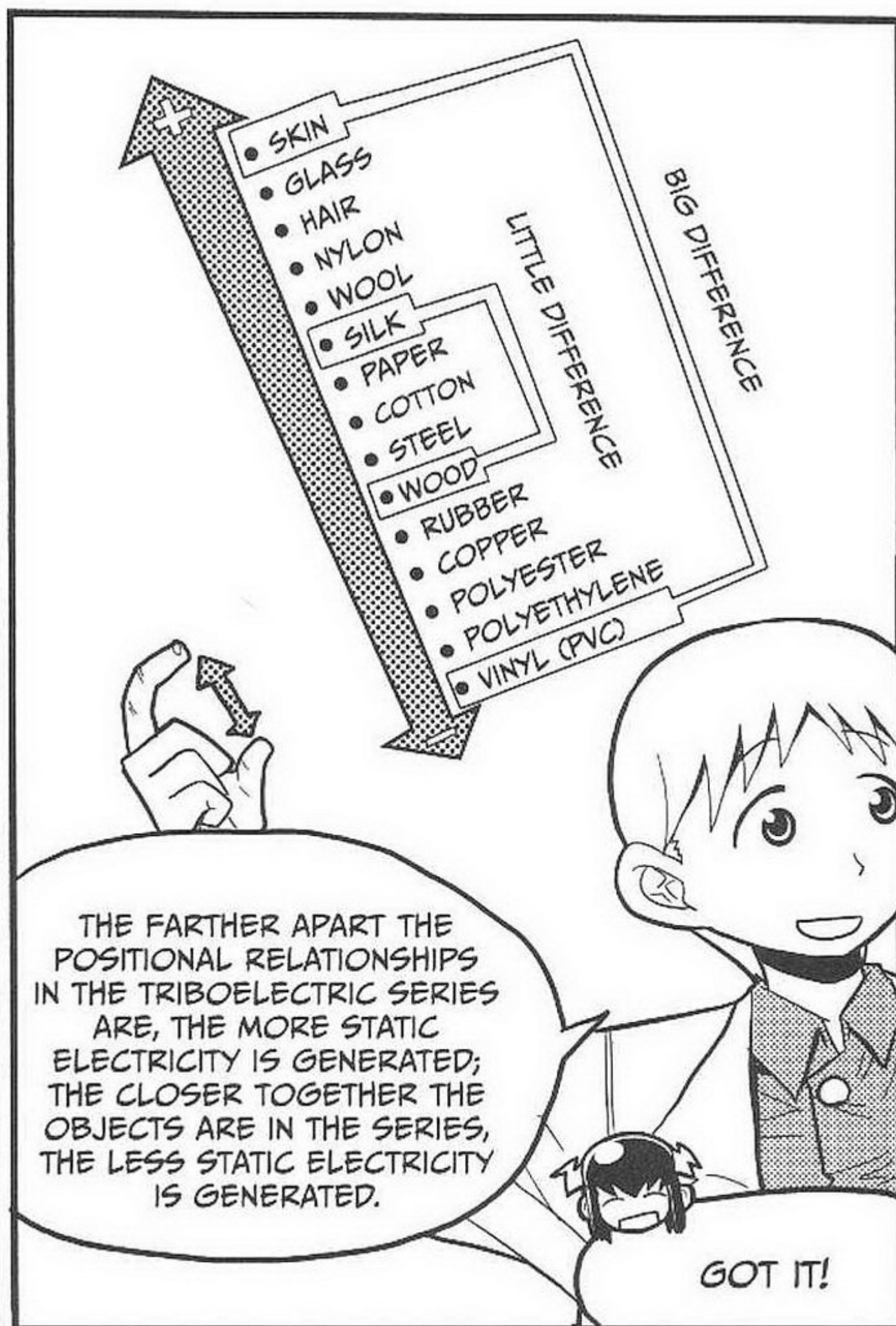
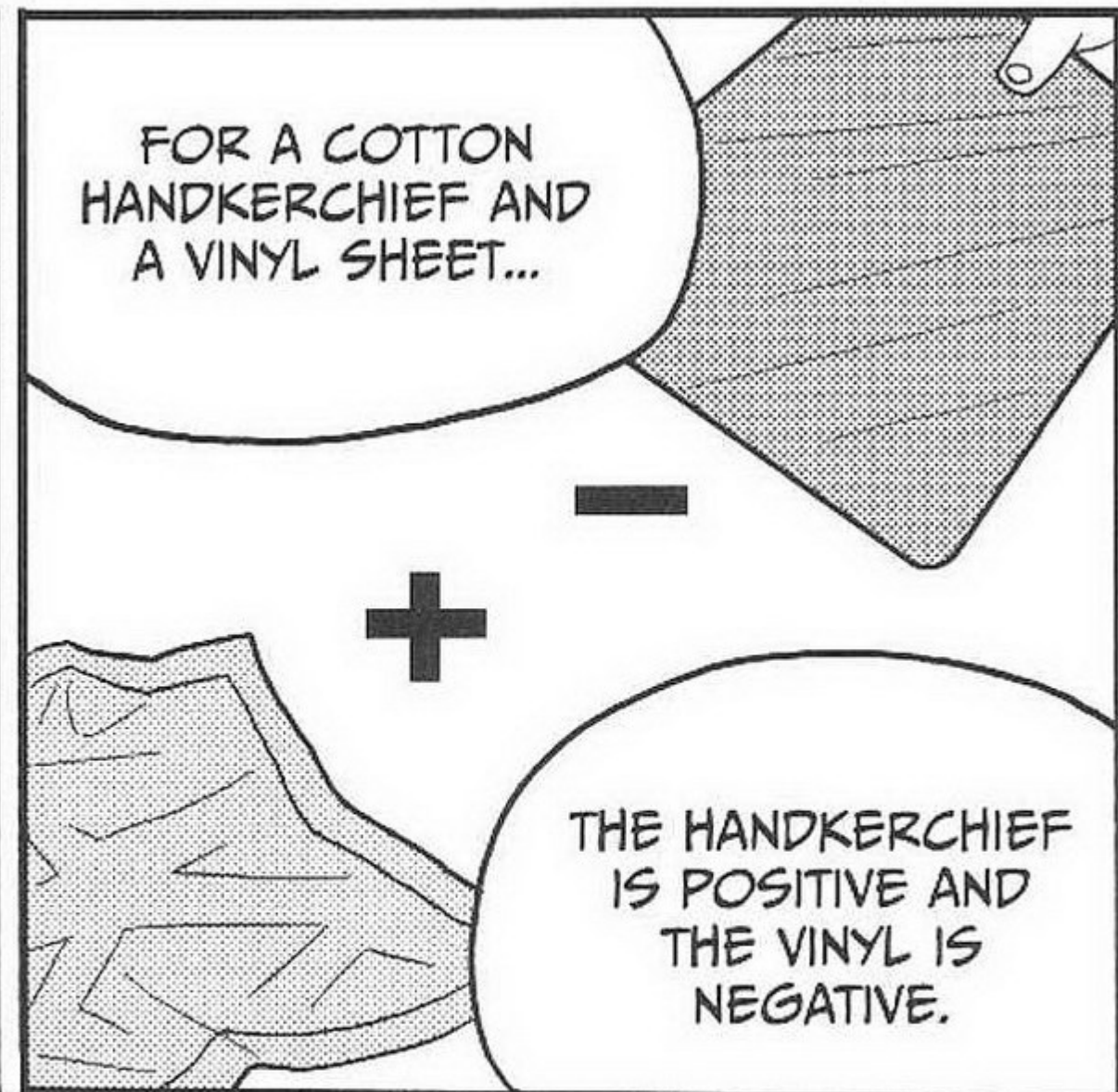

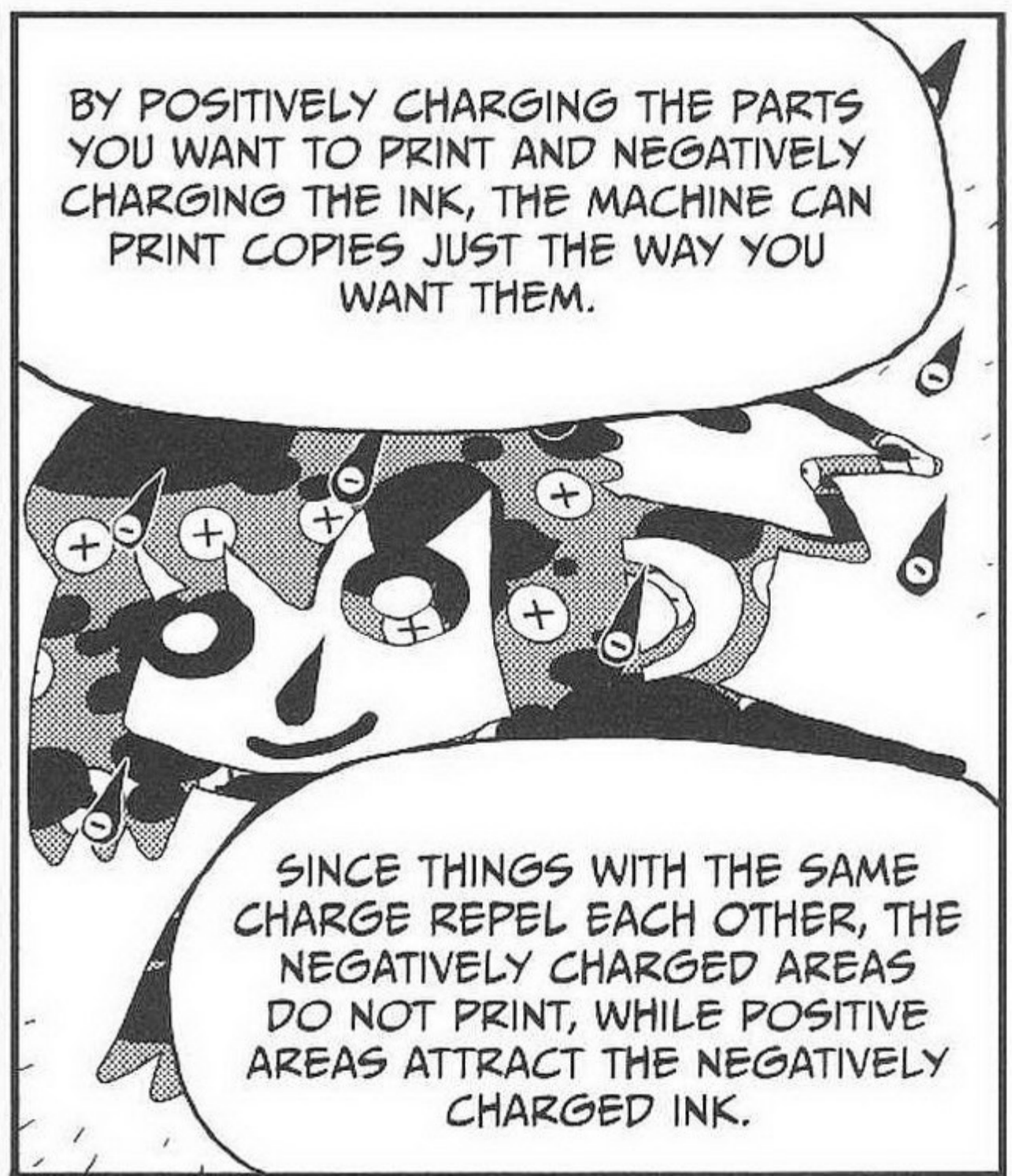
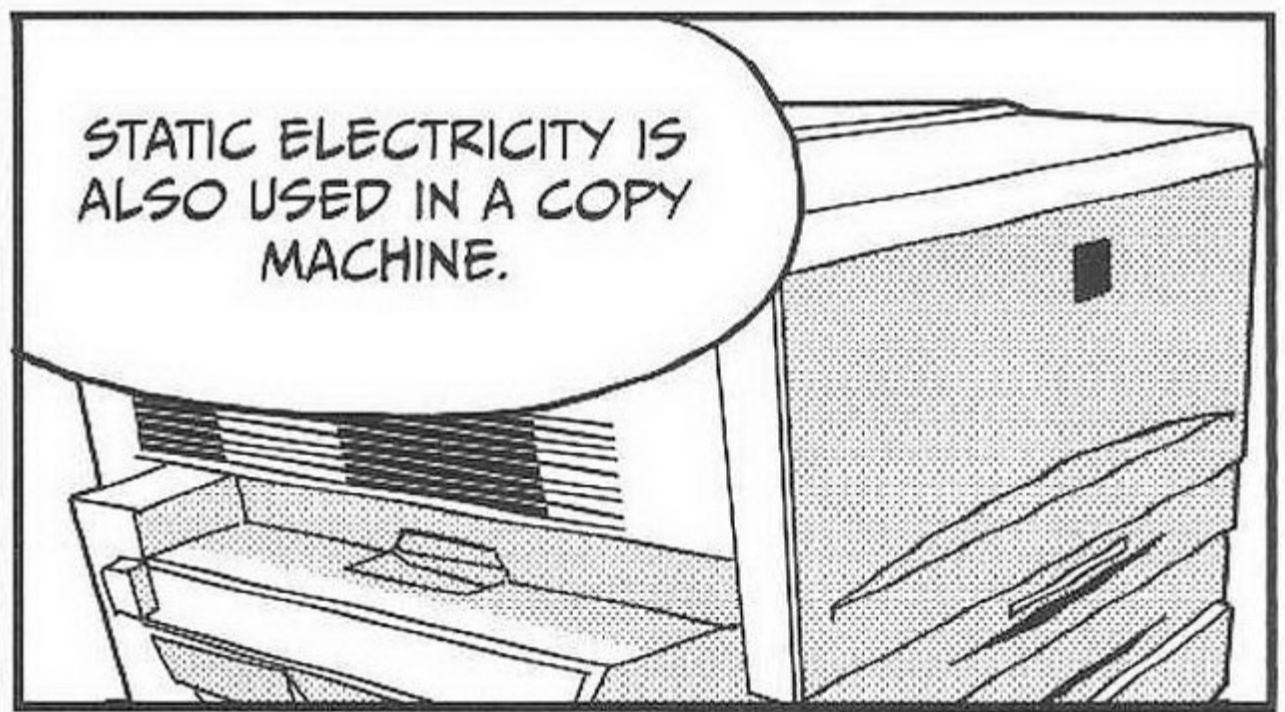
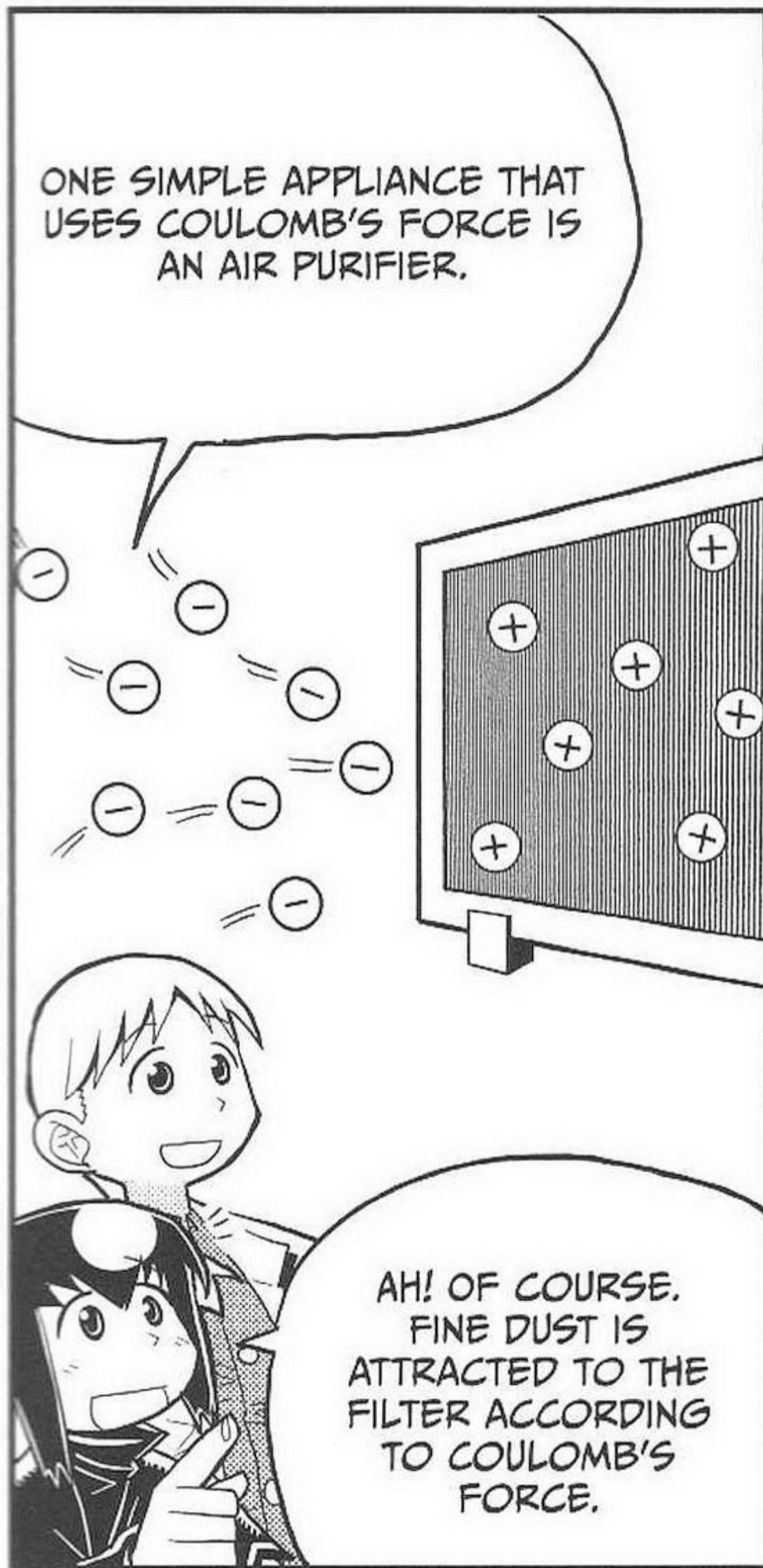
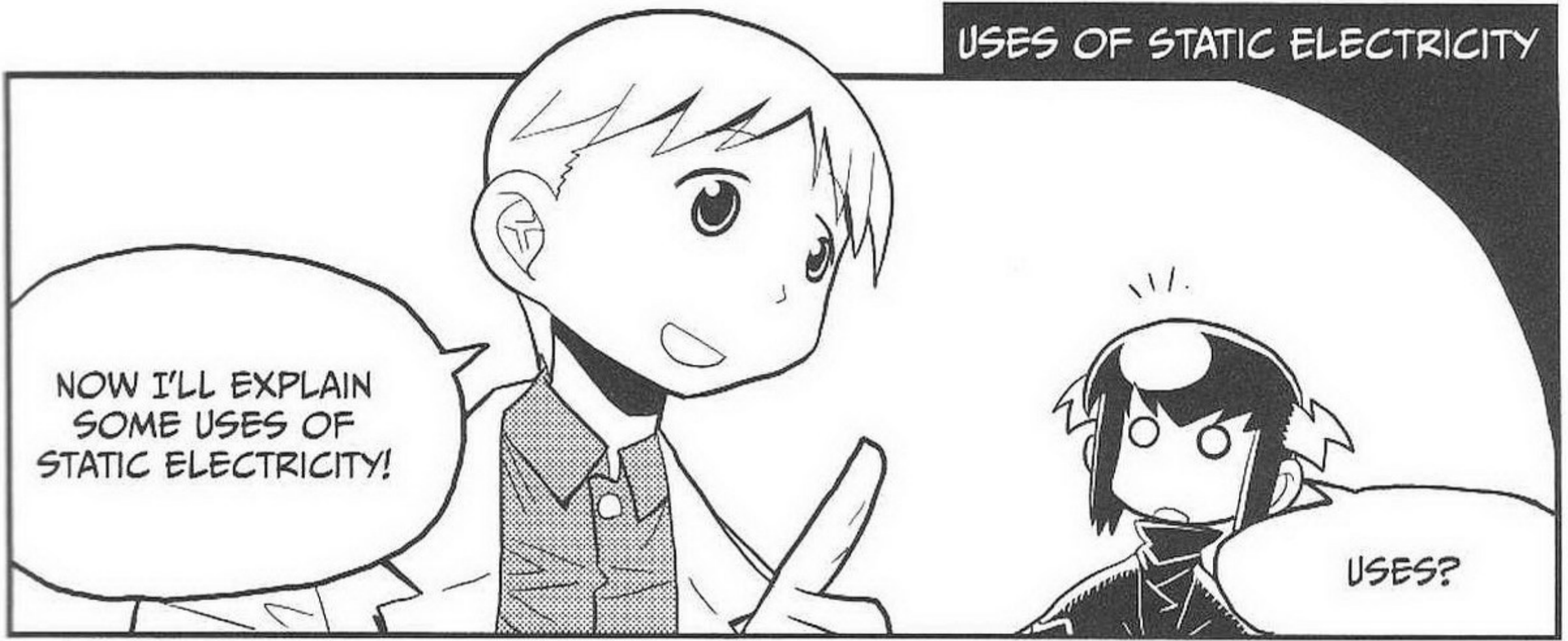



TAGS ON CONSUMER ELECTRIC PRODUCTS

Consumer electric products have tags related to electricity with information such as voltage, current, and power—for example, 120V, 1440W, and 12A.

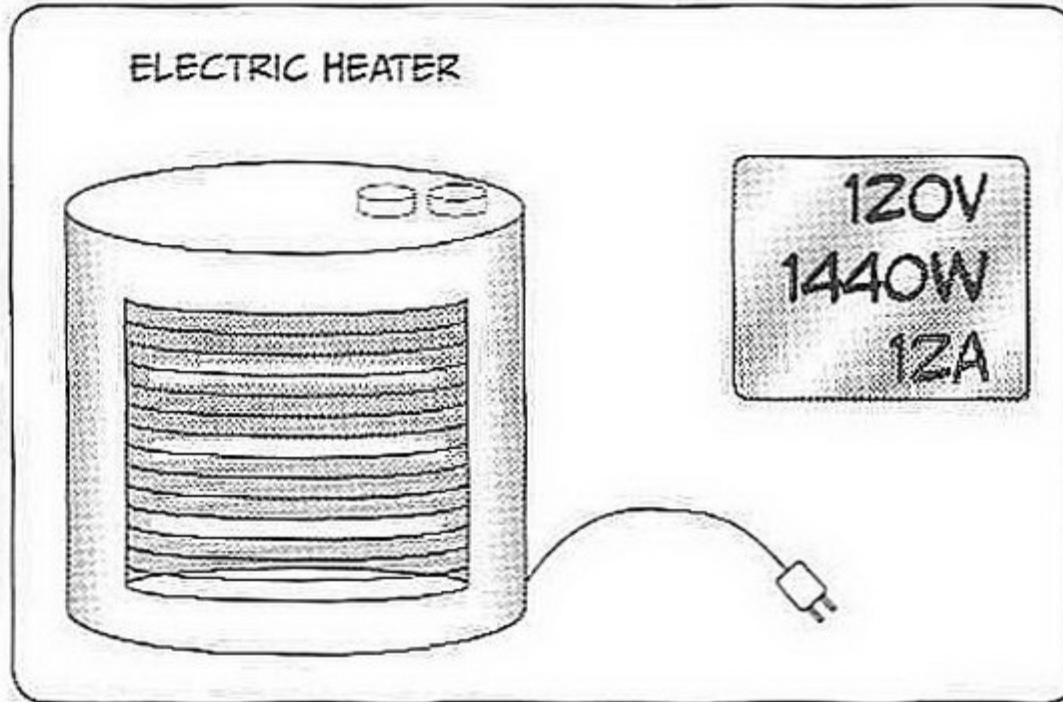

A tag on an electric heater

Voltage, the potential difference or “pressure” that makes electricity flow, is represented by the symbol V . The unit used to measure voltage is the *volt* (V), which is named for the Italian physicist Alessandro Volta, who invented the battery. The voltage used in an ordinary household appliance is 120V in the United States, 240V in Europe, and 100V in Japan.

Current is the quantity of electricity flowing per second through an electric line, and it is represented using the symbol I , which comes from the initial letter of *Intensity of electricity*. Current is measured in *amperes* (A), or *amps* for short, which are named for the French physicist André Marie Ampère. One amp is equal to one coulomb per second.

Power, which is the electric energy consumed in one second when current flows, is represented using the symbol P . Power is measured in *watts* (W), which are named for the British mechanical engineer James Watt, who invented the steam engine. One watt is equal to one joule per second.

You can determine the power a device draws by multiplying its voltage and current. The power of a 120V device in which 12A of current flows is $P = V \times I = 120V \times 12A = 1440W$.

A typical American household contains many 120V devices. If you divide the power value that is displayed on each of these devices by 120V, you can find the value of the current that flows in each device. For devices with the same power, a 240V electronic device runs using half the current of an 120V electronic device.

Since $P = V \times I$, we can rearrange this equation to look like this using simple algebra.

$$I = \frac{P}{V}$$

For a 120V electric device... $I = \frac{1440W}{120V} = 12A$...12A of current flows.

For a 240V electric device... $I = \frac{1440W}{240V} = 6A$...6A of current flows.

SI PREFIXES

1000W may also be represented by 1kW. This is because *k* stands for *kilo* and represents 1,000 or 10^3 . But we can use other prefixes, too: 3,600,000 joules (J) are equal to 3.6 megajoules (MJ). These prefixes for different powers of 10 are called *SI prefixes*, and they come from internationally determined rules for units called the *International System of Units (SI units)*. The most common ones are shown in the table below.

SI PREFIXES OFTEN USED IN ELECTRICAL RELATIONSHIPS

| Prefix Symbol | Name | Quantity |
|---------------|-------|-----------------------------------|
| T | tera | $10^{12} = 1,000,000,000,000$ |
| G | giga | $10^9 = 1,000,000,000$ |
| M | mega | $10^6 = 1,000,000$ |
| k | kilo | $10^3 = 1,000$ |
| m | milli | $10^{-3} = 0.001$ |
| μ | micro | $10^{-6} = 0.000\ 001$ |
| n | nano | $10^{-9} = 0.000\ 000\ 001$ |
| p | pico | $10^{-12} = 0.000\ 000\ 000\ 001$ |

You can find the amount of *energy*, which is the total amount of *work* done by an electrical device, by multiplying the power it draws and the time the device operates. Power is often measured by power companies in kWh (kilowatt hours). For example, if an electric heater with 1kW is used for 1 hour, the amount of energy it uses is $1\text{kW} \times 1\text{ hour} = 1\text{kWh}$.

However, when time is represented in seconds, Ws (watt second) can be used for the energy's unit. A watt-second is equivalent to a *joule (J)*. For example, when a 1kW electric heater is used for 1 hour, since $1\text{ hour} = 60\text{ minutes} \times 60\text{ seconds} = 3600\text{ seconds}$, the amount of energy used is $1\text{kW} \times 3600\text{ seconds} = 3600\text{kWs}$ or 3,600,000 joules.

You can calculate how much it will cost to use an ordinary household appliance by multiplying the amount of energy used (in kWh) by the utility company's price per kWh (you will also need to add in any flat-rate charges, if your utility company has them). Since the average electrical utility charge for 1kWh in the United States is approximately 12 cents for 1kWh, if a device with 1kW of power is used for 1 hour, the amount of energy used is 1kWh, and the electrical utility charge will be approximately 12 cents.

VOLTAGE AND POTENTIAL

Electricity flows from a high potential to a low potential. The potential difference between two points is called *voltage*. For example, for a AA battery, if we let the negative pole be the reference point, then the potential of the negative pole is 0V and the potential of the positive pole is 1.5V. The potential difference between the positive and negative poles is the *supply voltage* of this battery.

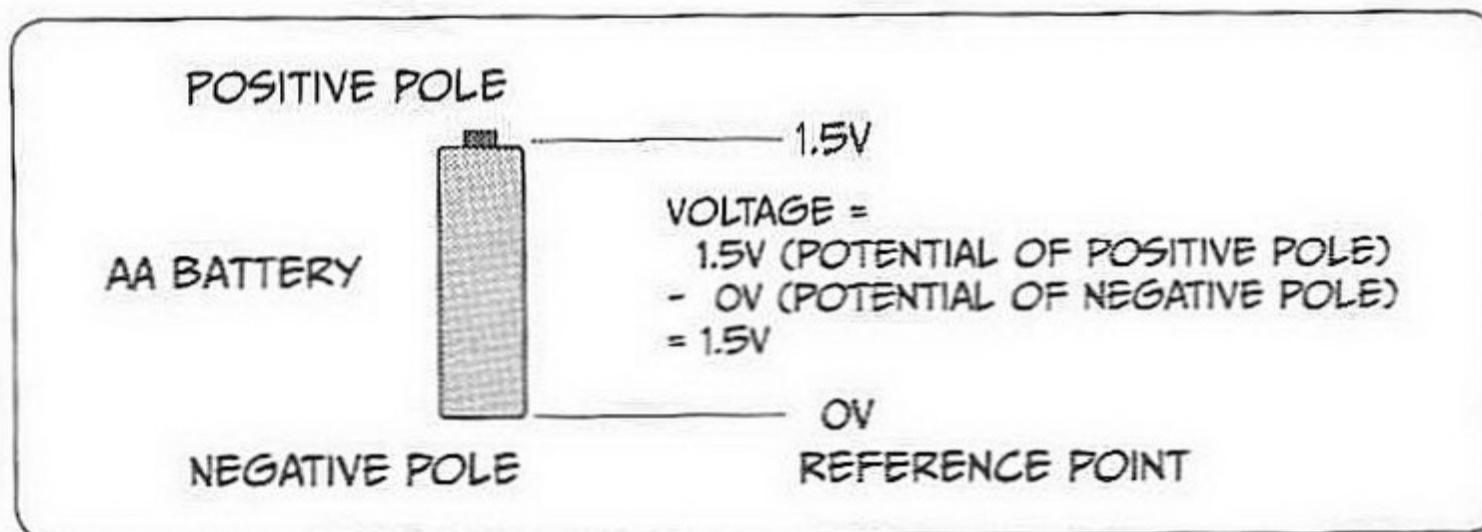

Supply voltage of a AA battery

If we stack two batteries and let the reference point be point B, the potential of point A is 1.5V, the potential of point B is 0V, and the potential of point C is -1.5V. The voltage between points A and C can be obtained by subtracting the potential of point C from the potential of point A; the voltage, in this case, is 3V. If we let point C be the reference point, the potential of point C is 0V, the potential of point B is 1.5V, and the potential of point A is 3V. The voltage is still 3V.

The larger the difference in electrical potential, the larger the voltage.

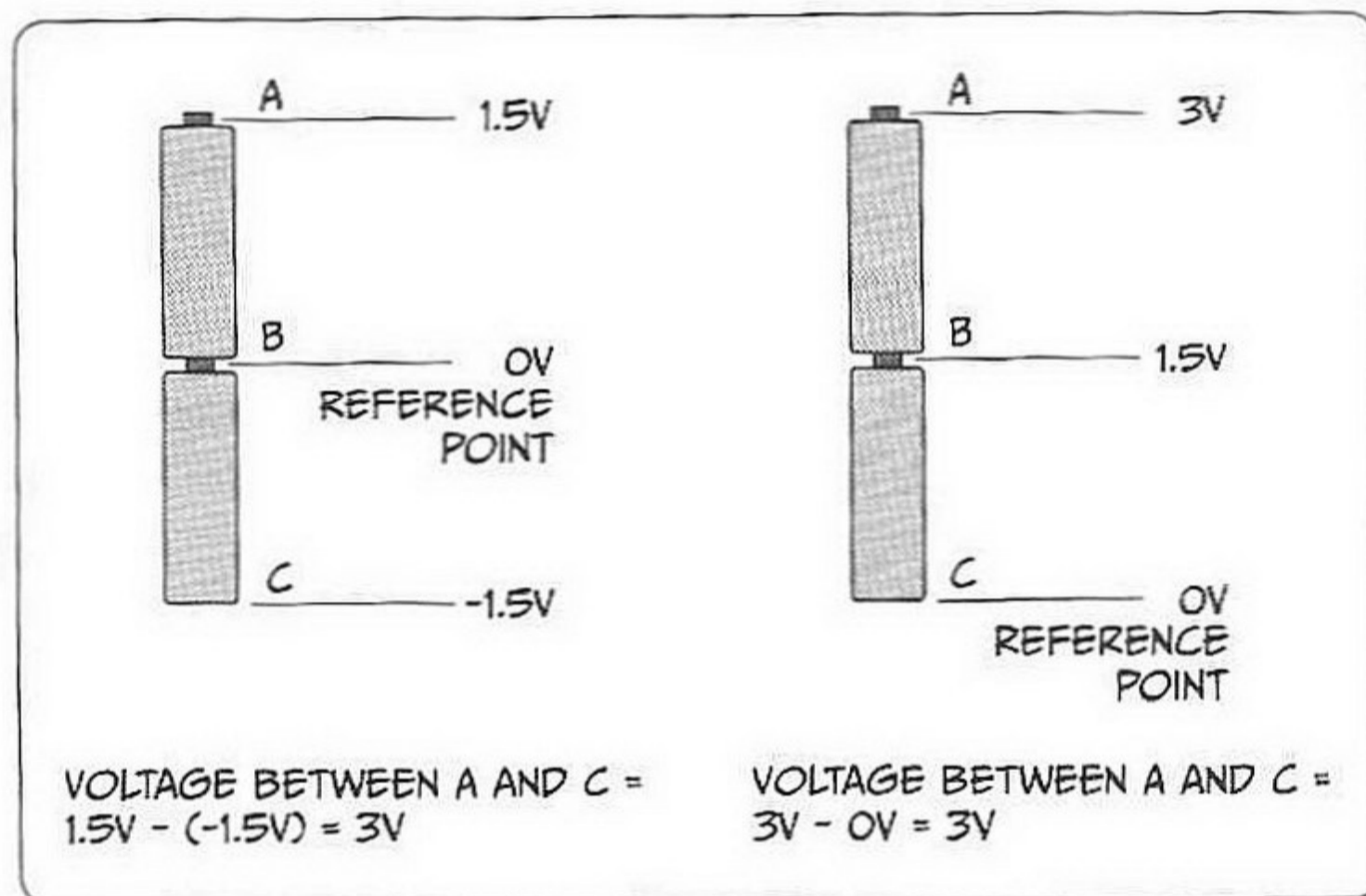

The voltage when two batteries are stacked

ATOMS AND ELECTRONS

All substances are made of atoms. An *atom* consists of a nucleus, which is made of protons and neutrons, and electrons. Since protons have a positive charge and neutrons are electrically neutral, the nucleus itself is electrically positive. Electrons, on the other hand, have a negative charge. But since protons and electrons are equally and oppositely charged, an atom is typically electrically neutral.

Electrons move around the nucleus in a series of orbits called *electron shells*. Since the attraction from the nucleus is weaker for electrons in the outermost shells than ones in the innermost shells, electrons in those outermost shells may escape from orbit if external energy such as heat or light is applied. An electron that has escaped from orbit can move around freely and is called a *free electron*. In substances like copper and other metals.

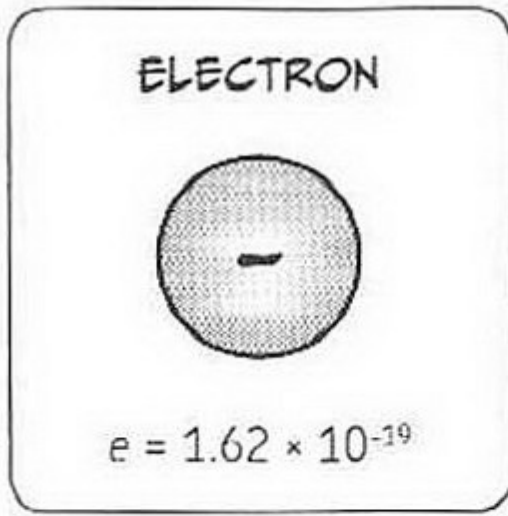

The smallest quantity of electricity that exists in the natural world is a single electron.

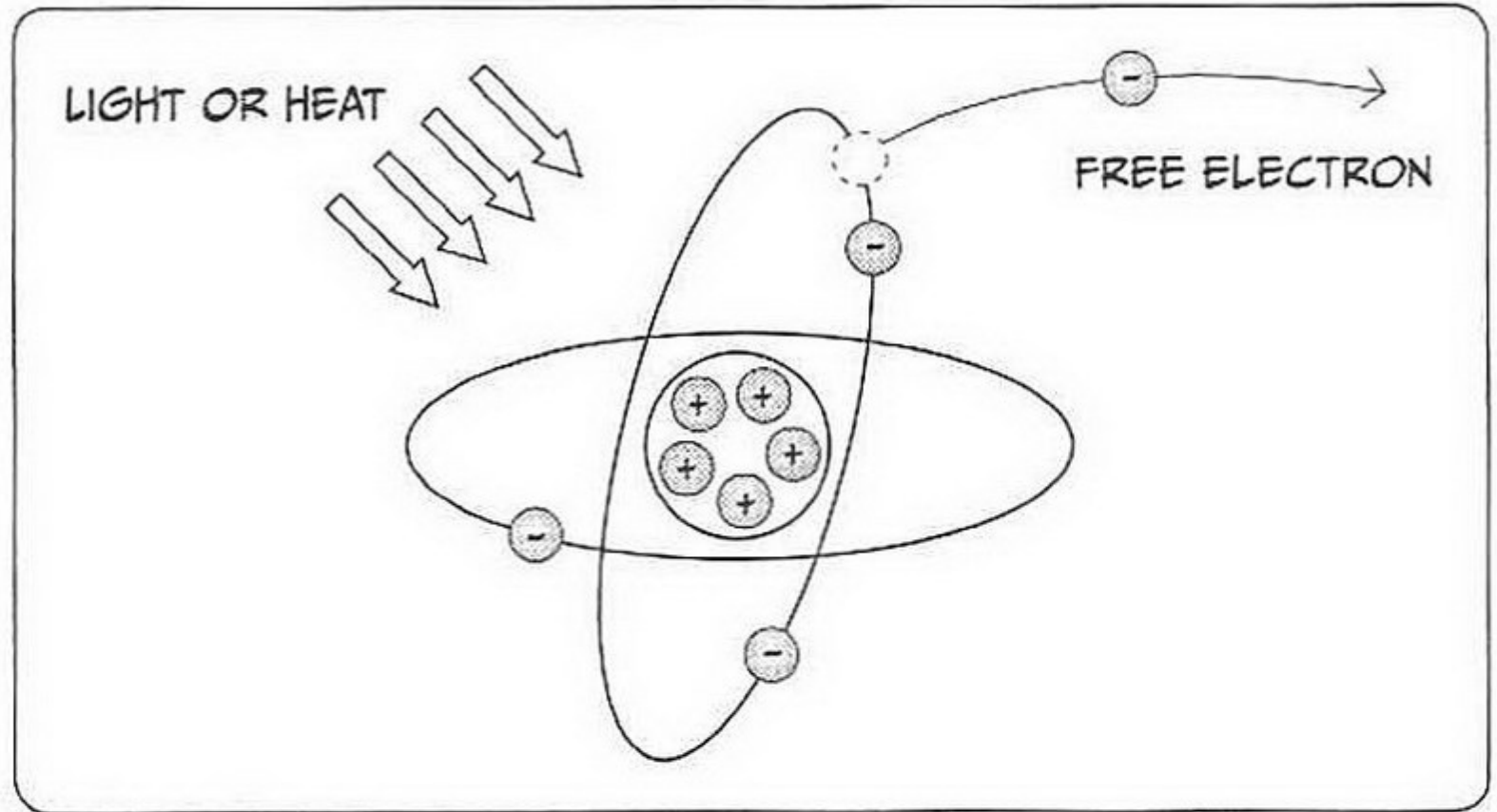

The escape of an electron

through which electricity easily flows, there are many free electrons, and if a voltage is applied to this substance, the free electrons all flow in one direction. This is how electricity flows through an electric line. The outermost electron shell of an atom is called the *valence shell*, and the electrons that are in it are called *valence electrons*.

The total number of electrons in an atom is the same as that atom's atomic number. Although there are many atoms with high atomic numbers and a lot of electrons, those substances are not necessarily ones through which electricity easily flows—the flow of electricity depends on the number of valence electrons.

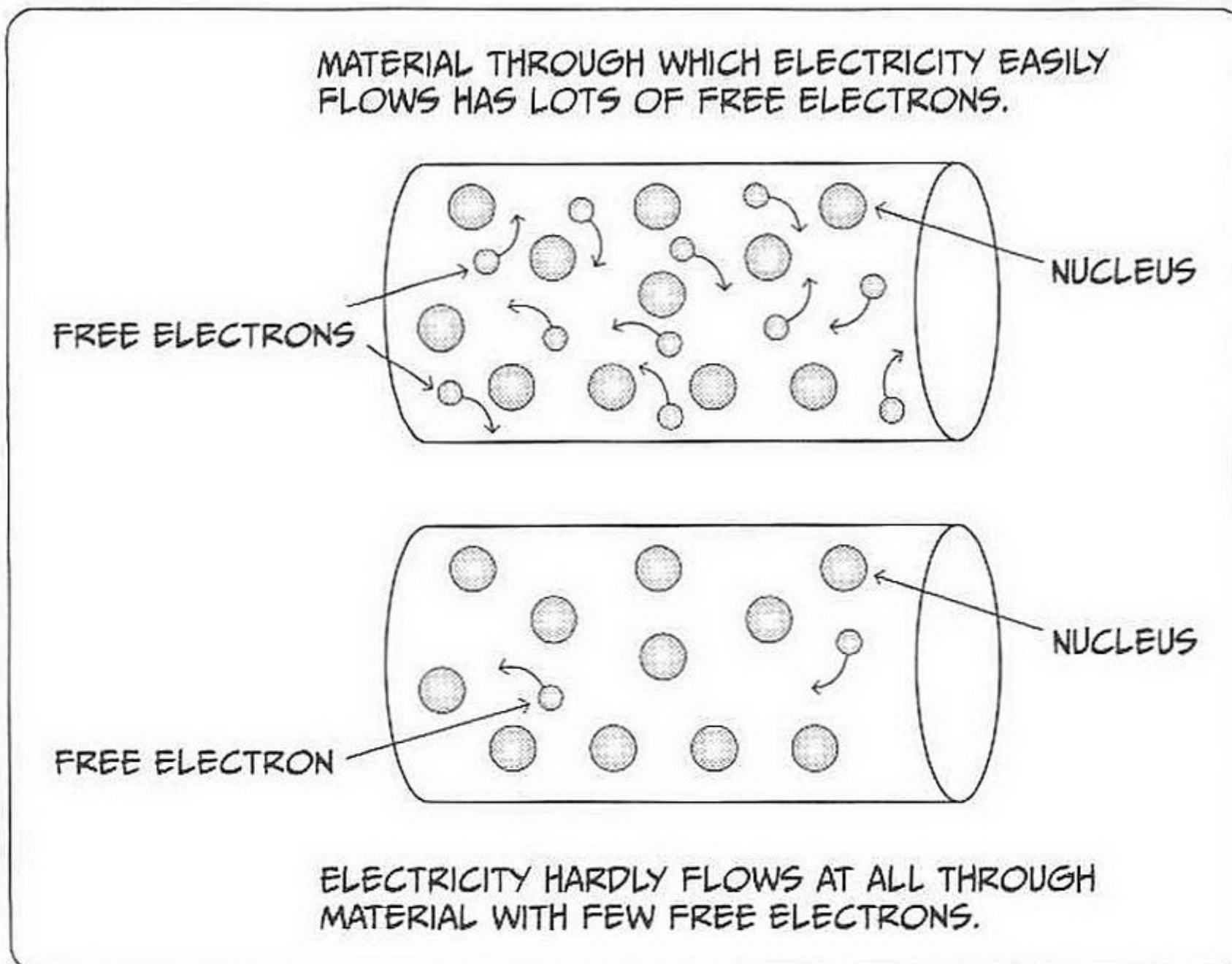

Different materials have different amounts of free electrons.

STATIC ELECTRICITY

When two different substances are rubbed together, atoms collide, and electrons that are easily separated from the atoms of one substance may escape and move to the atoms of the other substance. At this time, the substance that lost electrons becomes positively charged, and the substance that gained electrons becomes negatively charged. A substance that carries electricity in this way is said to be *charged*, and since this electricity is stationary (that is, it's not flowing), it is called *static electricity*. The quantity of the positive charge that is generated by this process is always the same as the quantity of the negative charge. Since static electricity is generated by friction, it is also called *frictional electricity*.

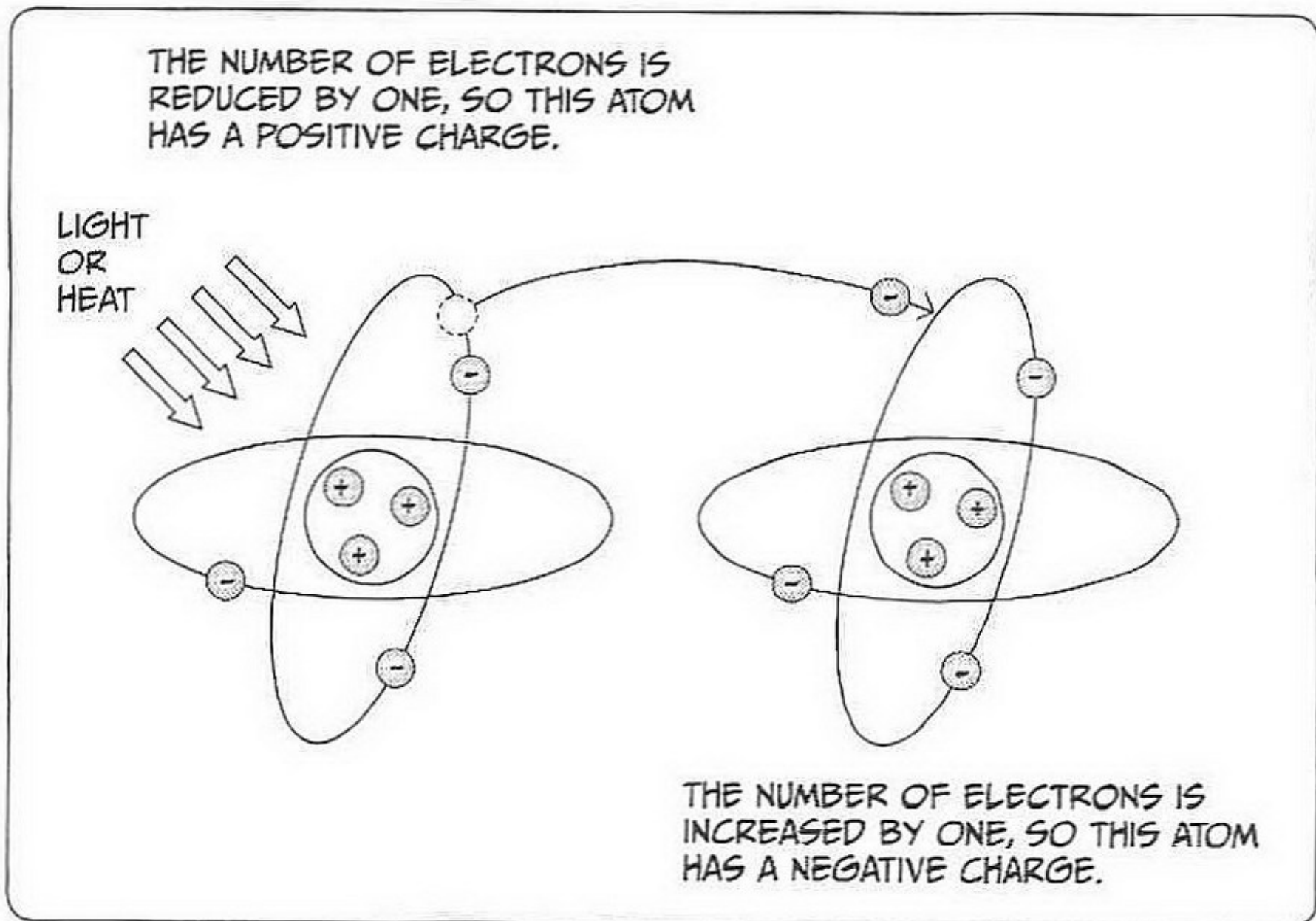

Electron movement and electric charge

ELECTROSTATIC FORCE

Charge is measured in *coulombs* and is represented by Q , the quantity of charge. The name of the unit comes from Charles Augustine Coulomb, a French physicist who studied electricity.

A force called *electrostatic force* (also known as *Coulomb's force*) operates between two charges. This force causes the same types of charge to repel each other and different types of charge to attract each other. The size of the electrostatic force F of attraction or repulsion (measured in a unit called a newton) operating between charge Q_1 and Q_2 is directly proportional to the product of Q_1 and Q_2 and inversely proportional to the square of the distance (r meters) between the charges. The stronger the charges, and the smaller the distance, the larger the resulting electrostatic force. This is called *Coulomb's law* with respect to static electricity.

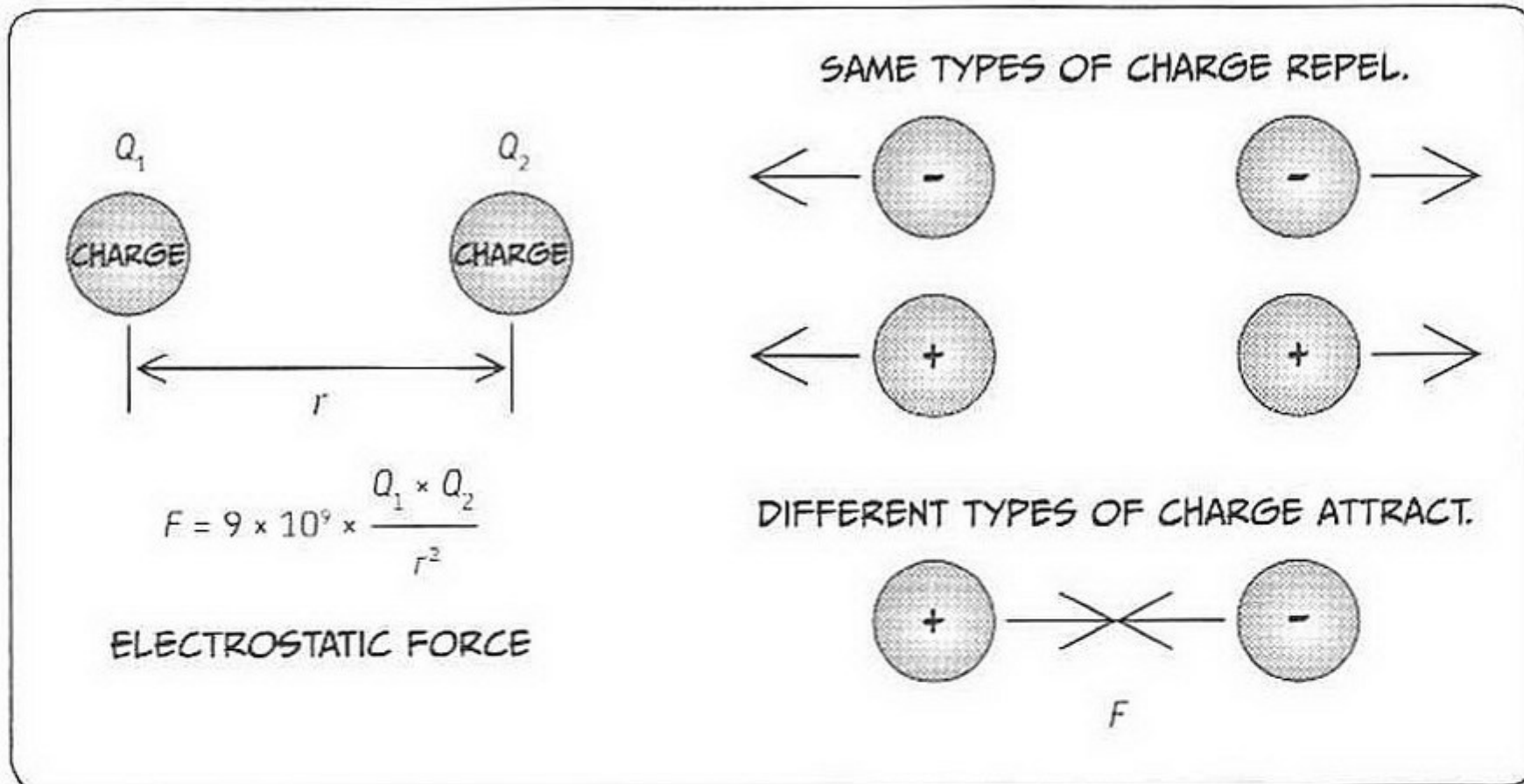

Electrostatic force operating between charges and Coulomb's law

If static electricity is generated by rubbing a vinyl sheet on a person's hair, the hair has a positive charge, the vinyl has a negative charge, and the hair clings to the vinyl due to the electrostatic force.

Also, if the negatively charged vinyl sheet is brought close to hair that has not been charged, the hair will become positively charged and will cling to the vinyl. This phenomenon, in which something that is not charged becomes charged when it is in close proximity to something else that is charged, is called *electrostatic induction*.

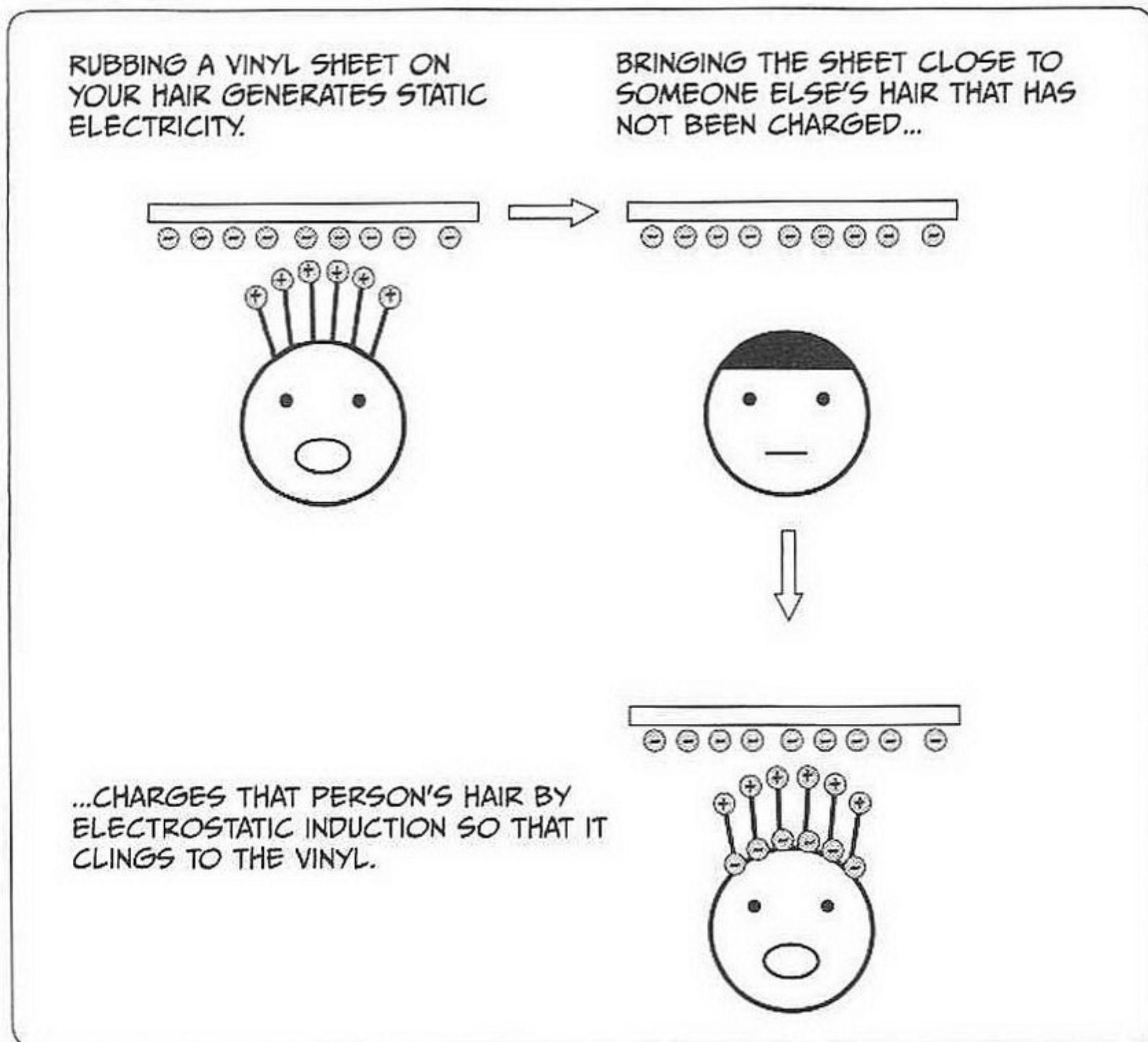

Electrostatic induction

THE TRIBOELECTRIC SERIES

Static electricity is more easily generated as the air gets drier—humidity prevents static electricity from gathering on a surface. Also, some clothes easily become charged, while others do not, depending on the material they are made from. Since silk has good water absorbency and contains much more moisture than synthetic fibers, it can reduce the occurrence of static electricity.

The polarities of the charges that are generated by friction differ according to the materials that are rubbed together. These differences are represented by the *triboelectric series*. For example, if hair and cotton are rubbed together, the hair will become positively charged and the cotton will become negatively charged, but for cotton and vinyl, the cotton will become positively charged and the vinyl will become negatively charged.

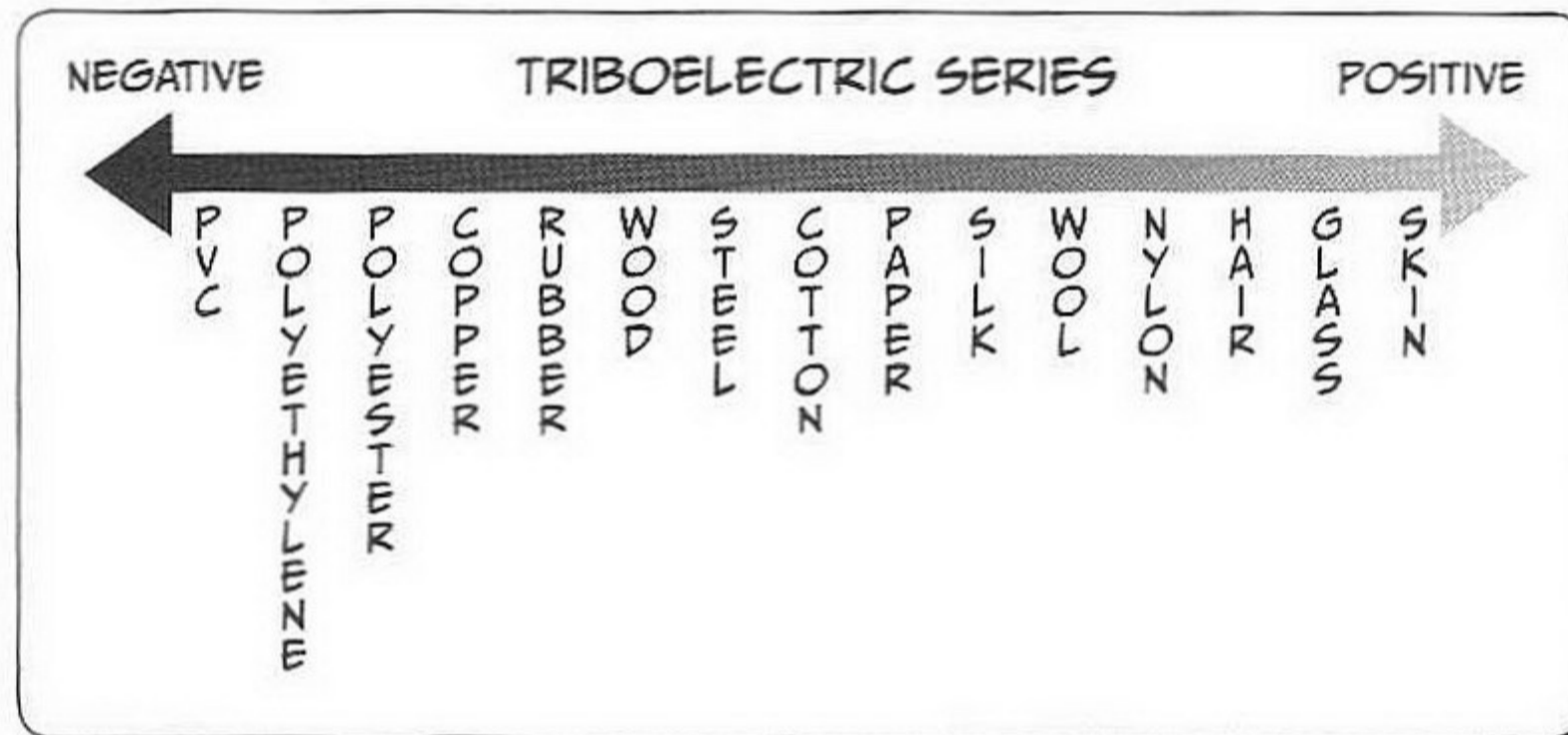

The triboelectric series

The farther apart the materials are in the triboelectric series, the more static electricity is generated between them, and the closer together the objects are in the triboelectric series, the less static electricity is generated. In other words, you can reduce the occurrence of static electricity by wearing clothes that are made of materials that are close together in the triboelectric series.

MOVEMENT OF CHARGE AND DIRECTION OF CURRENT

Lightning is also a result of static electricity. Lightning occurs when the static electricity that is produced by the friction between hail and ice particles in a cloud discharges between the cloud and ground. In the case of lightning, air (which is an insulator through which electricity has difficulty flowing) exists between the positive and negative charges, so a discharge does not easily occur.

When a large amount of charge builds up and the potential difference between the positive and negative charges is extremely large, the insulation of the air suddenly breaks down and an electrical discharge occurs. *Electrical discharge* is the phenomenon in which charge flows continuously. This continuous flow of electricity is called *current*.

Electric current flows from positive to negative. Scientists have discovered that the movement of electrons, however, is from negative to positive. Therefore, the direction in which the electrons move is actually opposite to the direction in which current flows.

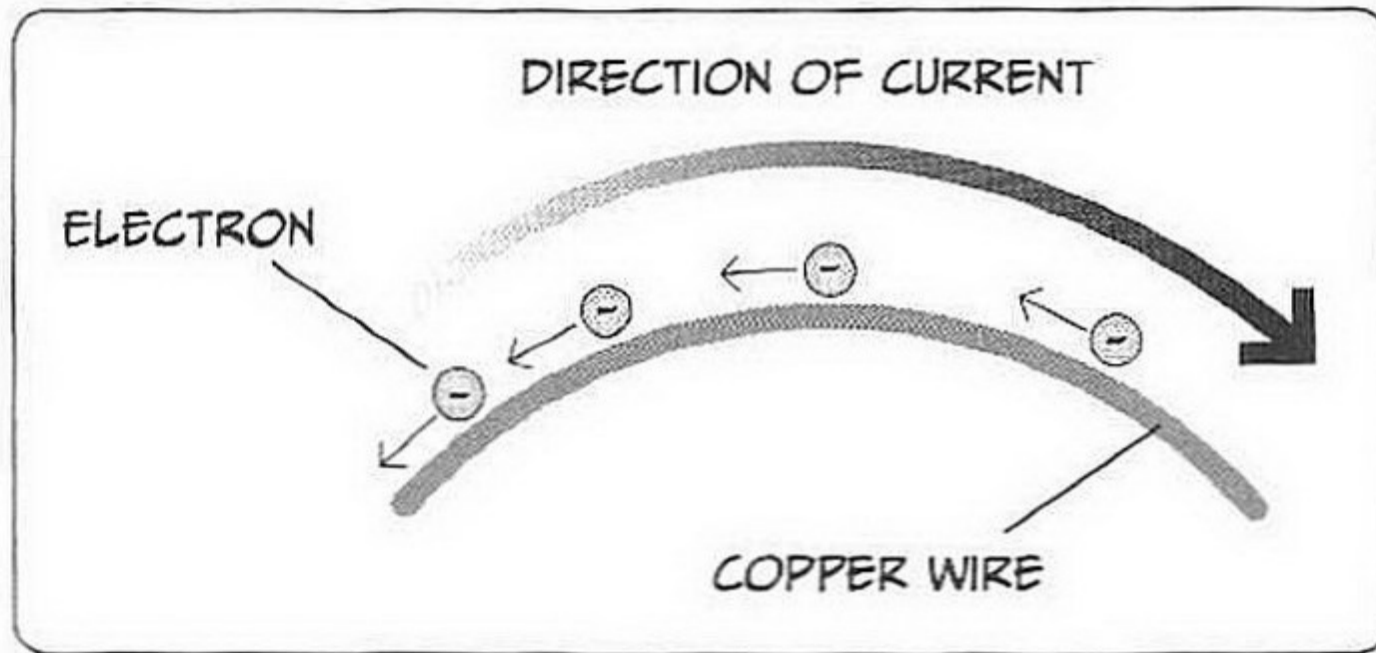

Direction of current and direction of electron movement

The amount of current is represented by the quantity of electricity passing through a wire in a second.

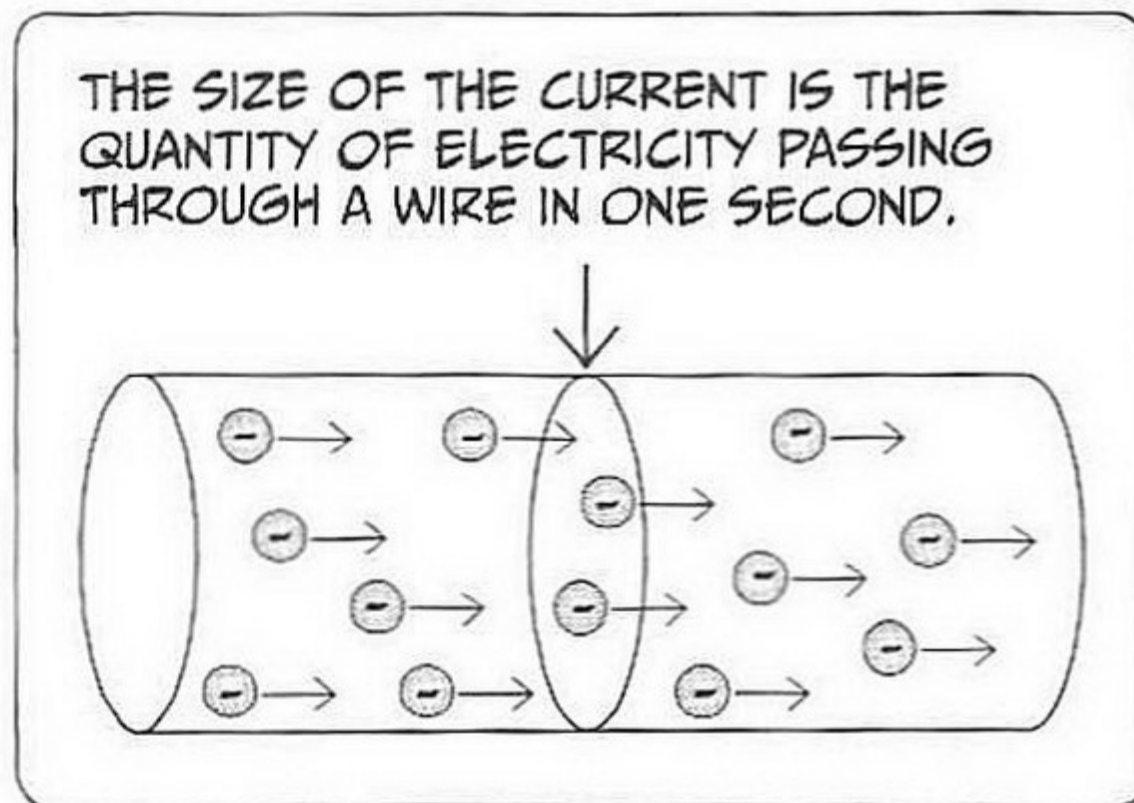

Size of the current

For example, when a charge of 1C passes through a given point, the current I can be obtained by dividing the charge (Q) in coulombs by the time (t) in seconds as follows.

$$I = \frac{Q}{t} = \frac{1\text{C}}{1\text{s}} = 1\text{A}$$

Also, the number of electrons flowing at 1A can be obtained by dividing 1C by the quantity of charge in 1 electron, as follows:

$$\frac{1\text{C}}{1.602 \times 10^{-19}\text{C/electron}} = 6.24 \times 10^{18} \text{ electrons}$$

In other words, when a current of 1A is flowing, there are 6.24×10^{18} electrons flowing per second.

The speed at which the electrons move is very slow—less than 1 cm per second. However, the speed at which electrical motion is transmitted to neighboring electrons is the same as the speed of light: 300,000 km per second. Therefore, the current also flows at 300,000 km per second (the speed of light).

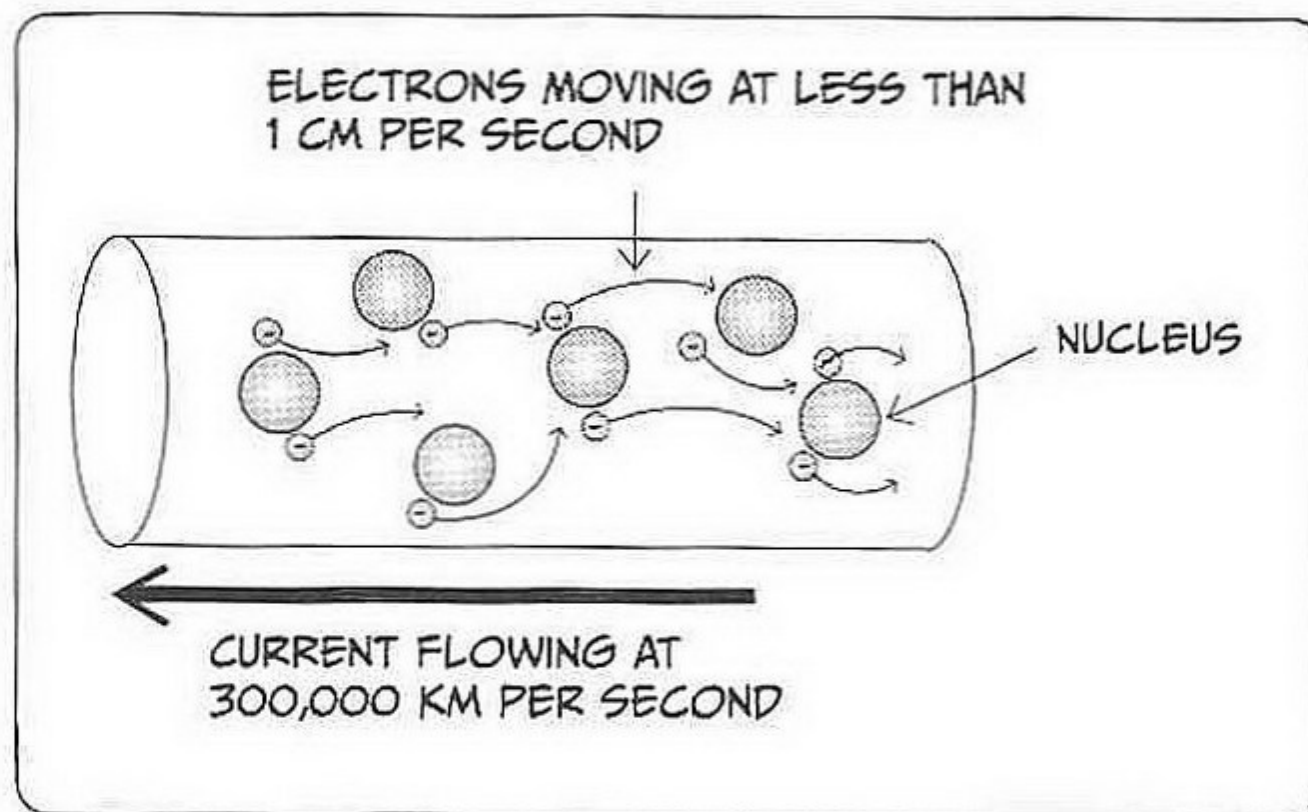

Speed of electrons and speed of current

Although electricity itself cannot be seen with the naked eye, heat or light is often produced when current flows. Therefore, we know that electricity exists by observing the phenomena caused by current.



2

WHAT ARE ELECTRIC CIRCUITS?

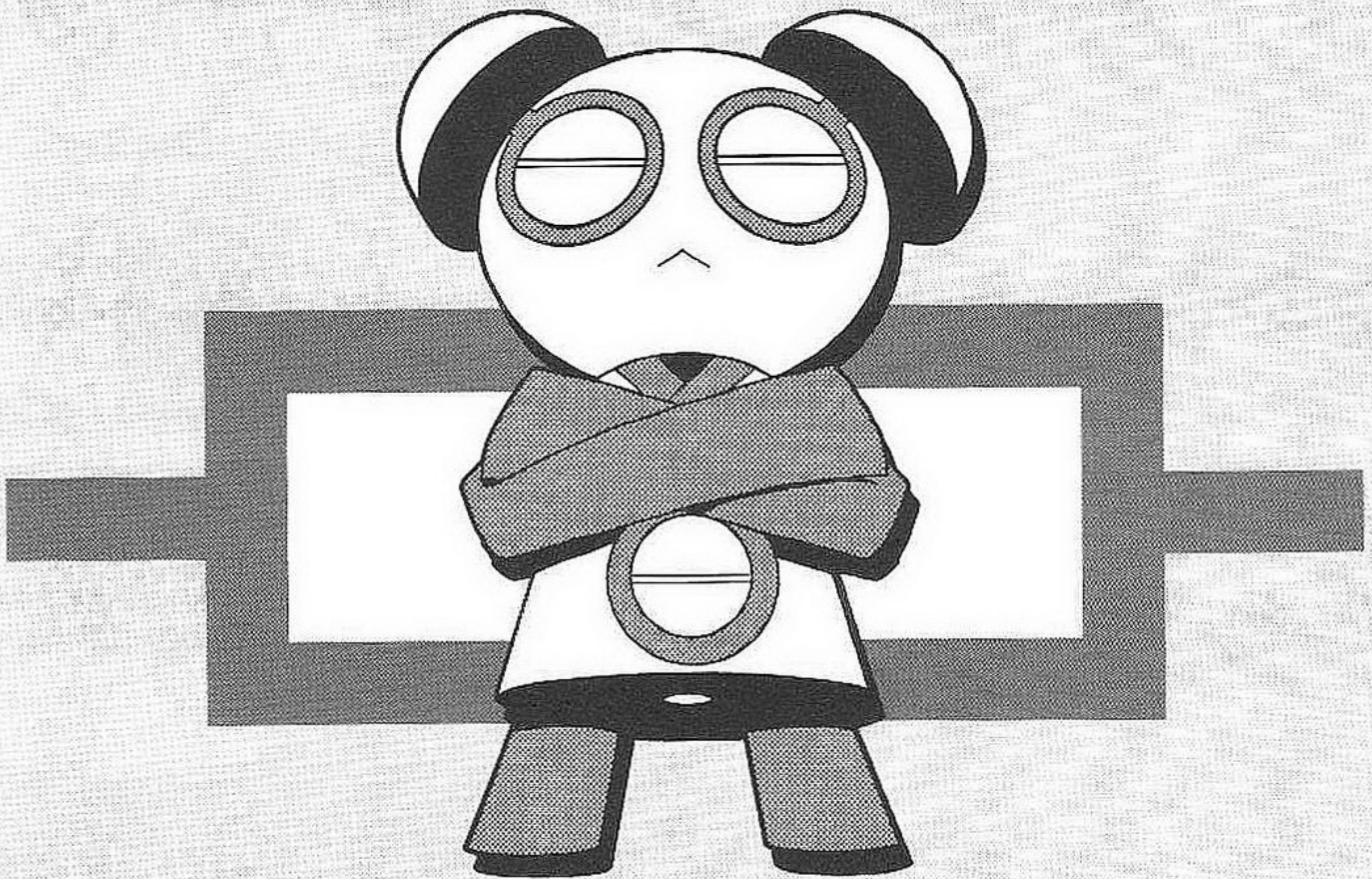

ELECTRIC CIRCUITS IN
EVERYDAY DEVICES



THANK YOU FOR
LOANING ME THESE
CLOTHES!



SURE! YOU STUCK OUT
LIKE A SORE THUMB
WALKING AROUND IN
THAT CRAZY OUTFIT.



MANY ELECTOPIANS
WHO HAVE COME
TO EARTH LIVE
PERFECTLY FINE
WEARING THEIR
REGULAR CLOTHES!

REALLY!?



DO YOU REALLY
THINK SO?



OF COURSE!
THEY HANG OUT AT
PLACES LIKE HARAJUKU...



WELL...



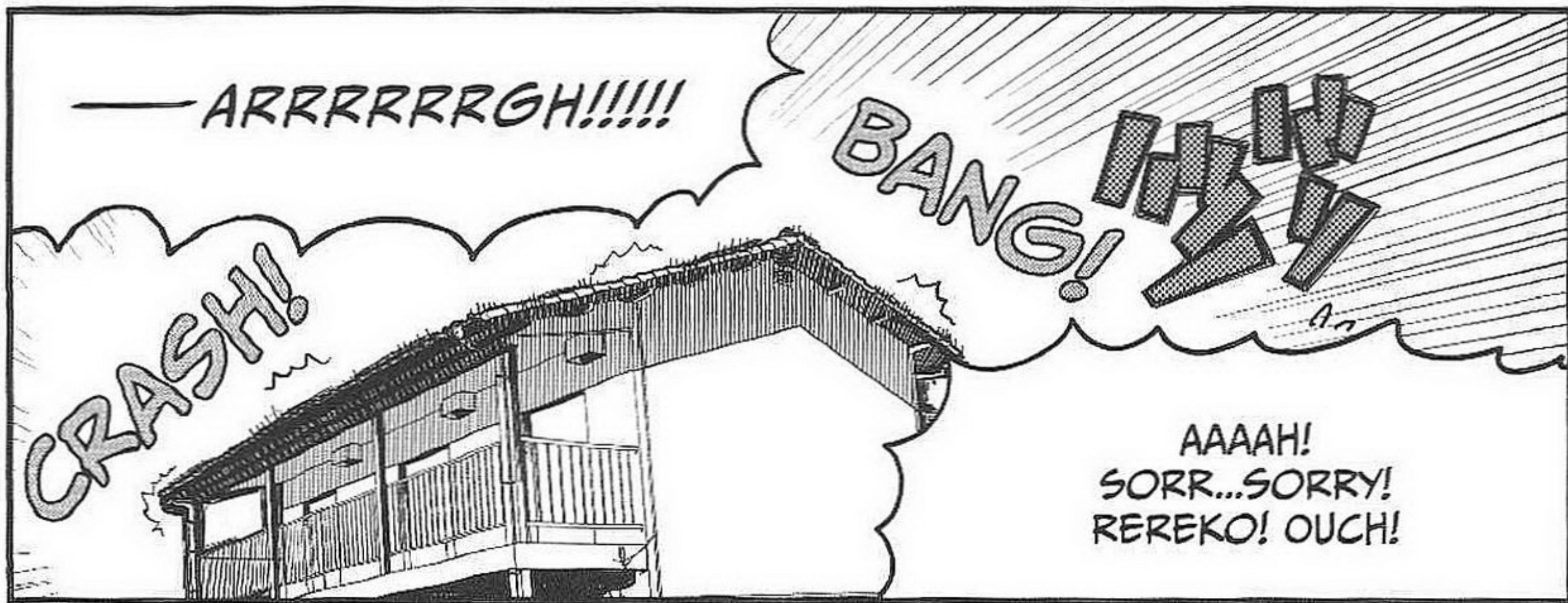

ARRRRRRRGGH!!!!

CRASH!

BANG!

AAAAH!
SORR...SORRY!
REREKO! OUCH!



ENOUGH! WHAT ARE YOU
DOING PLAYING AROUND WITH
THE FLASHLIGHT YOU JUST
BOUGHT?!

CLICK

HEE HEE!
I'M SORRY!

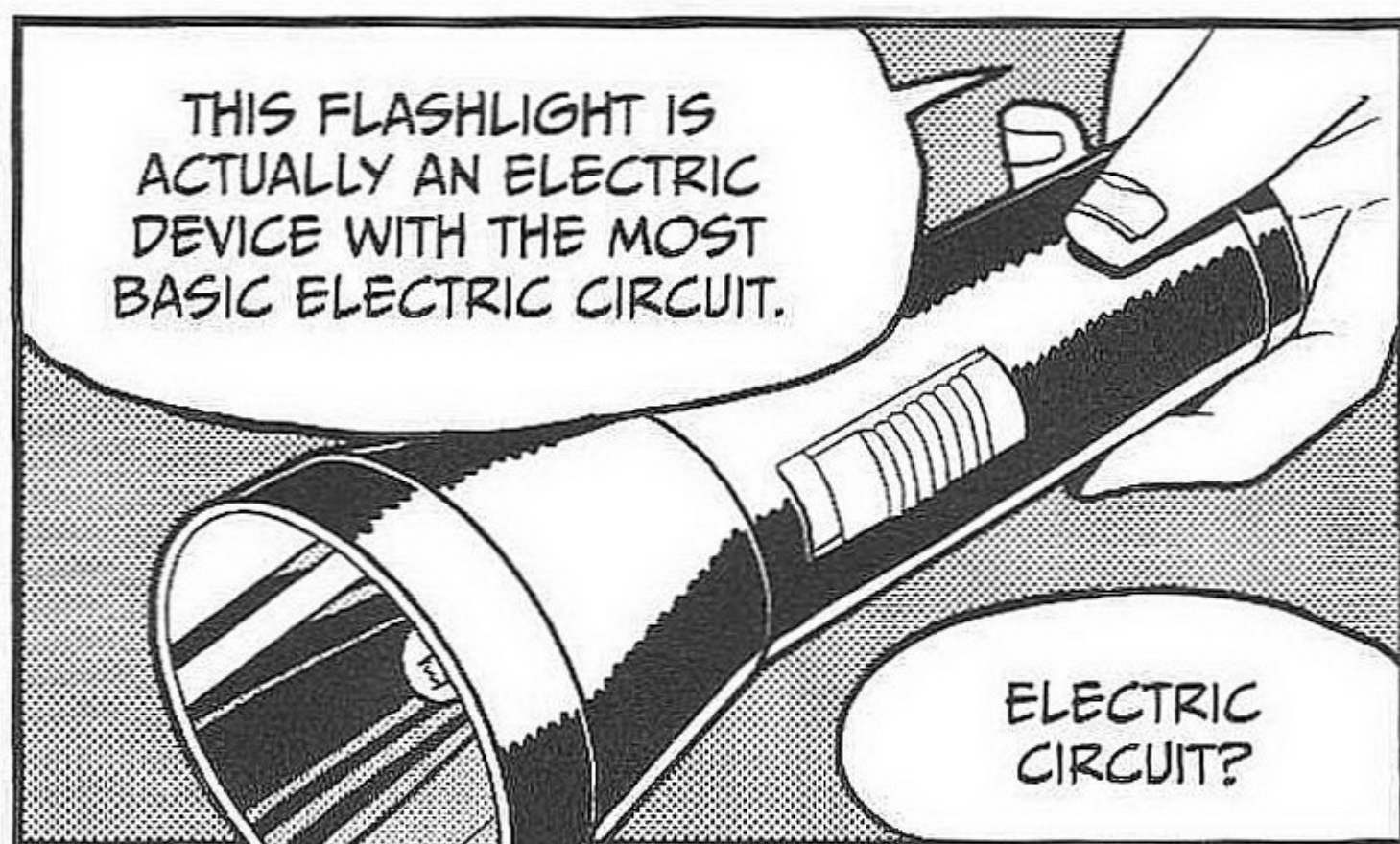

THIS FLASHLIGHT IS
ACTUALLY AN ELECTRIC
DEVICE WITH THE MOST
BASIC ELECTRIC CIRCUIT.

ELECTRIC
CIRCUIT?

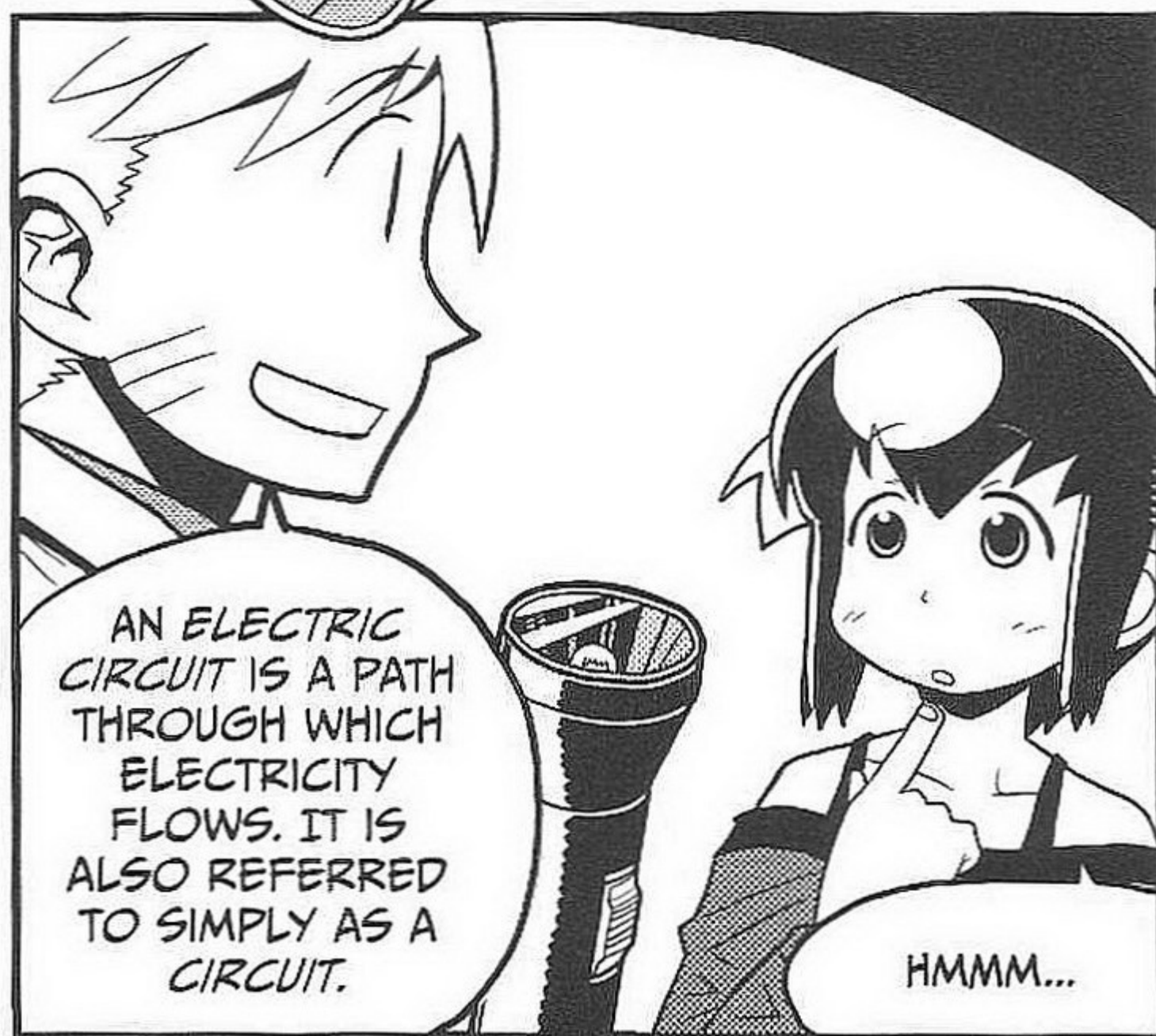

AN ELECTRIC
CIRCUIT IS A PATH
THROUGH WHICH
ELECTRICITY
FLOWS. IT IS
ALSO REFERRED
TO SIMPLY AS A
CIRCUIT.

HMMM...

A FLASHLIGHT'S CIRCUIT

THE INSIDE OF A FLASHLIGHT LOOKS SOMETHING LIKE THIS...



IT'S SO SIMPLE!

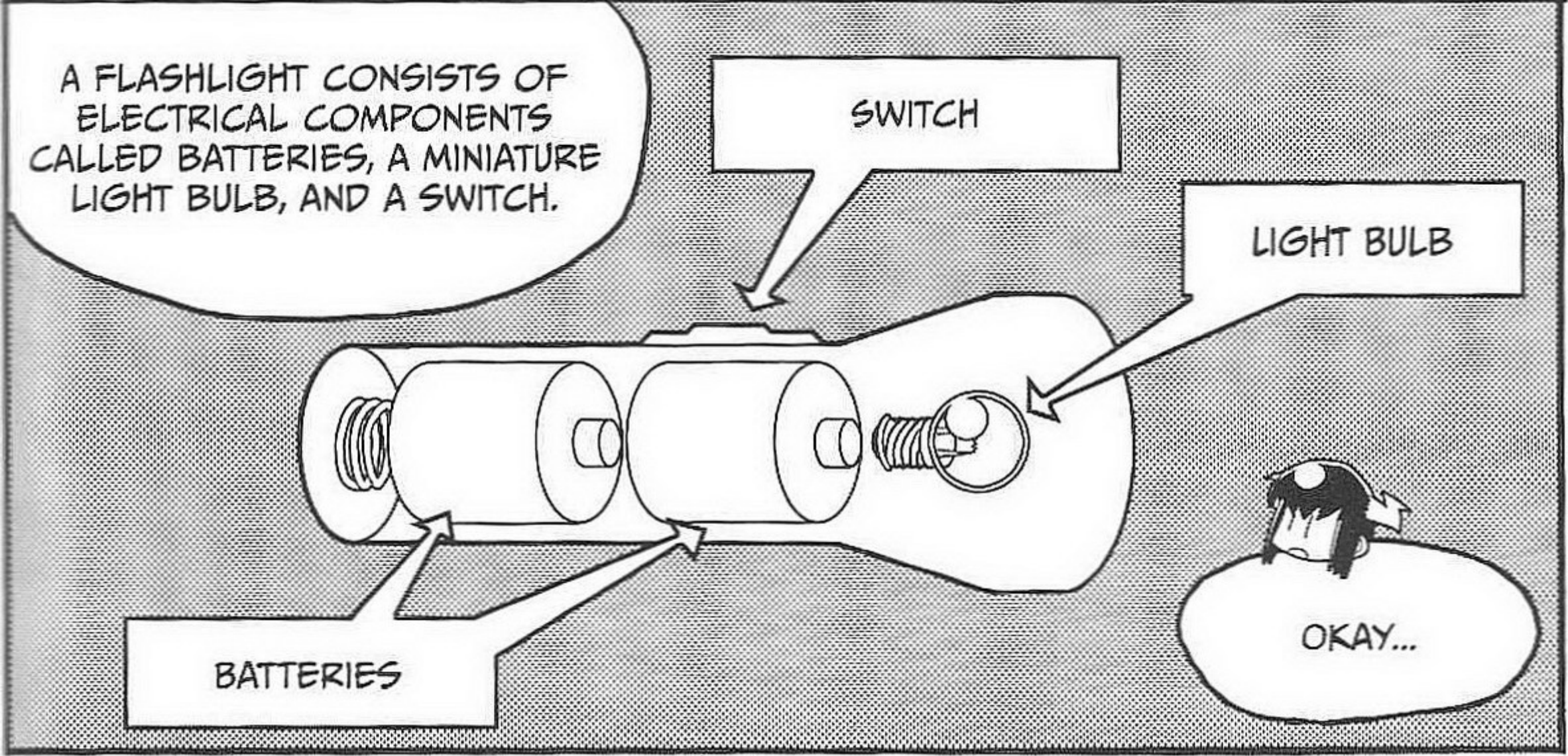

A BATTERY IS A PRODUCT THAT HAS VOLTAGE (THAT IS, A POTENTIAL DIFFERENCE).

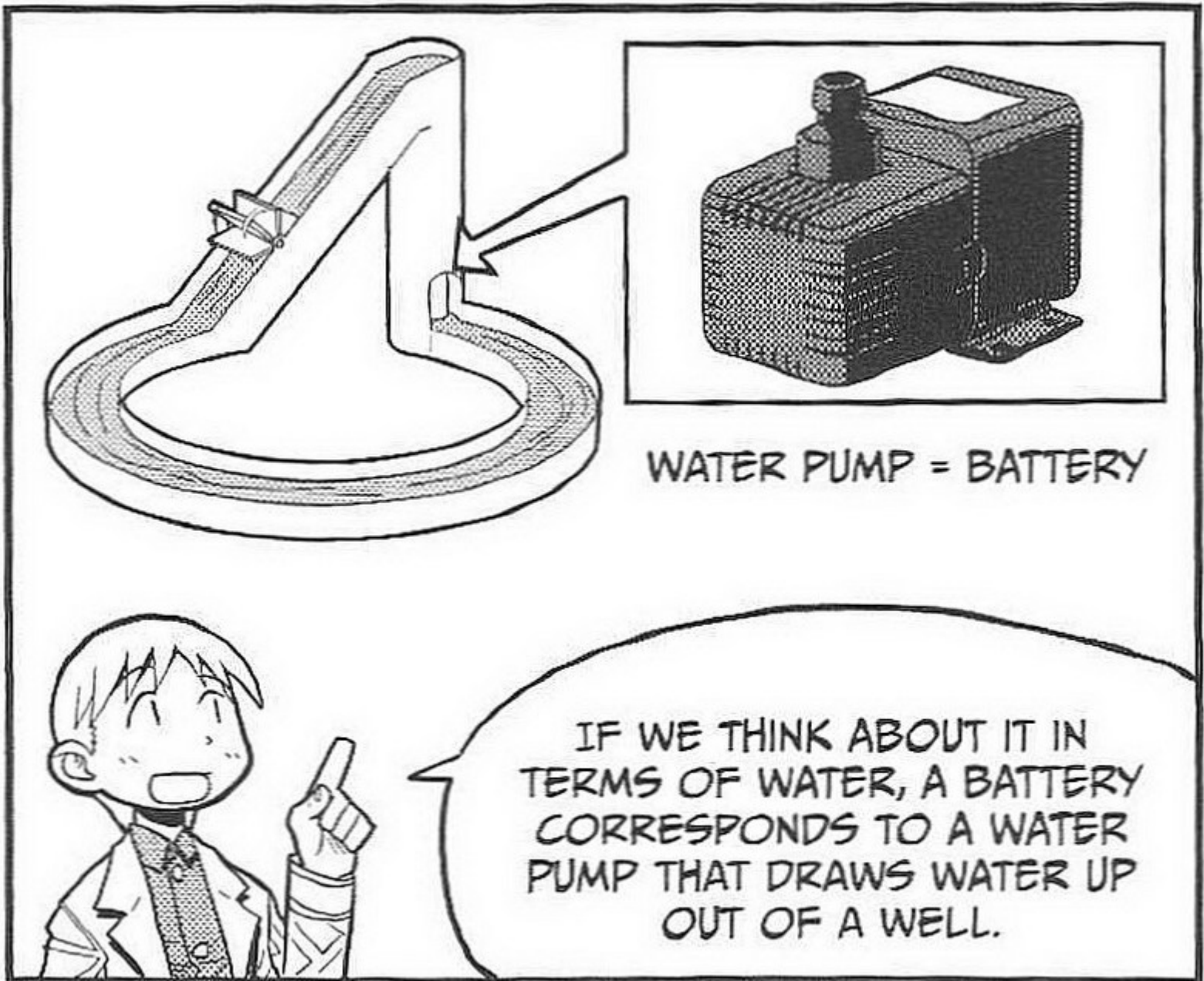

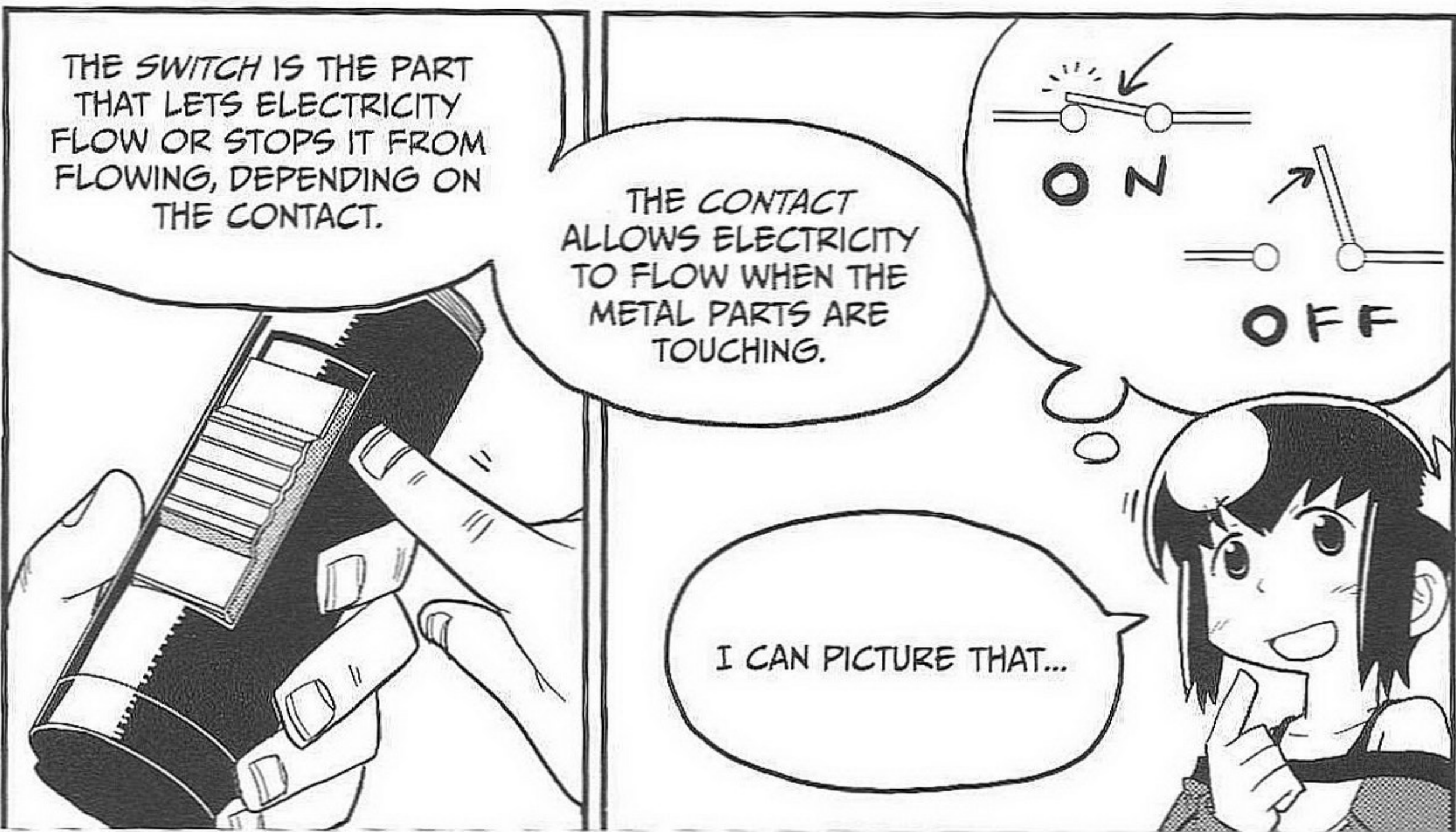
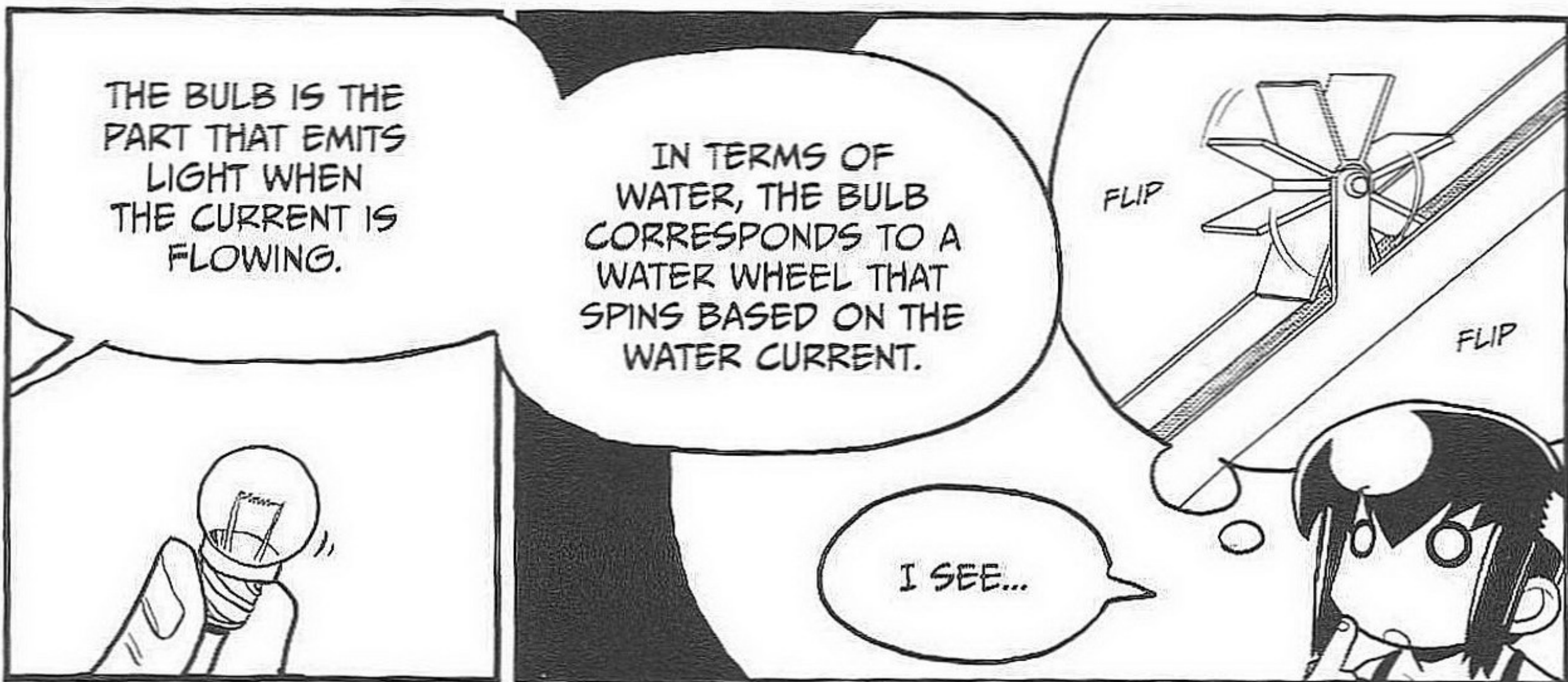

WHEN THE SWITCH IS CLOSED, CURRENT LEAVES THE POSITIVE POLE OF THE BATTERY, PASSES THROUGH THE MINIATURE BULB AND SWITCH, AND RETURNS TO THE NEGATIVE POLE.

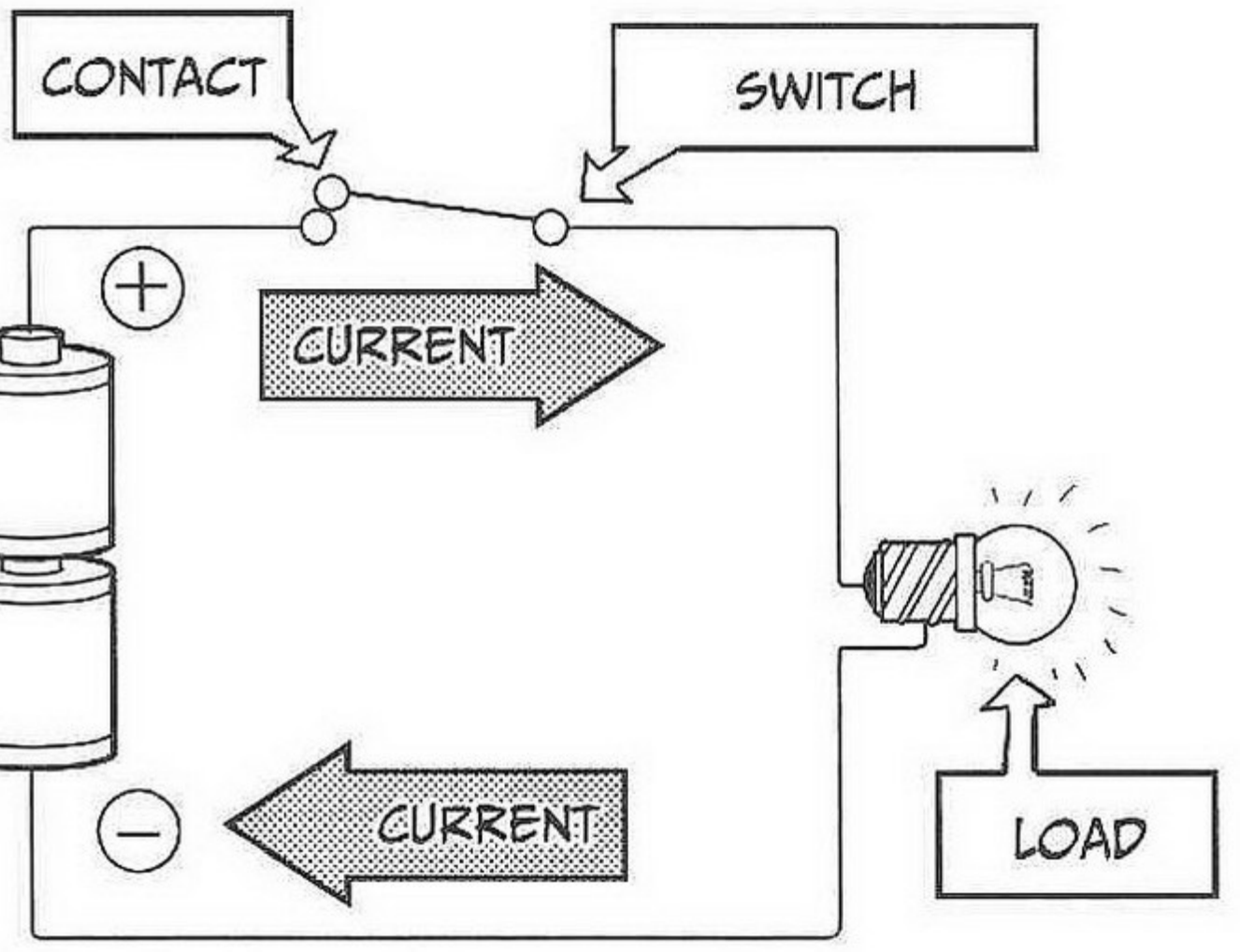

THE PATH THROUGH WHICH THIS CURRENT FLOWS IS CALLED AN *ELECTRIC CIRCUIT*, WHICH ALWAYS HAS A CLOSED FORM (CLOSED CIRCUIT).

PARTS OF AN ELECTRIC CIRCUIT

THE VOLTAGE OF THE POWER SUPPLY IS CALLED THE *POWER SUPPLY VOLTAGE* OR *ELECTROMOTIVE FORCE*.

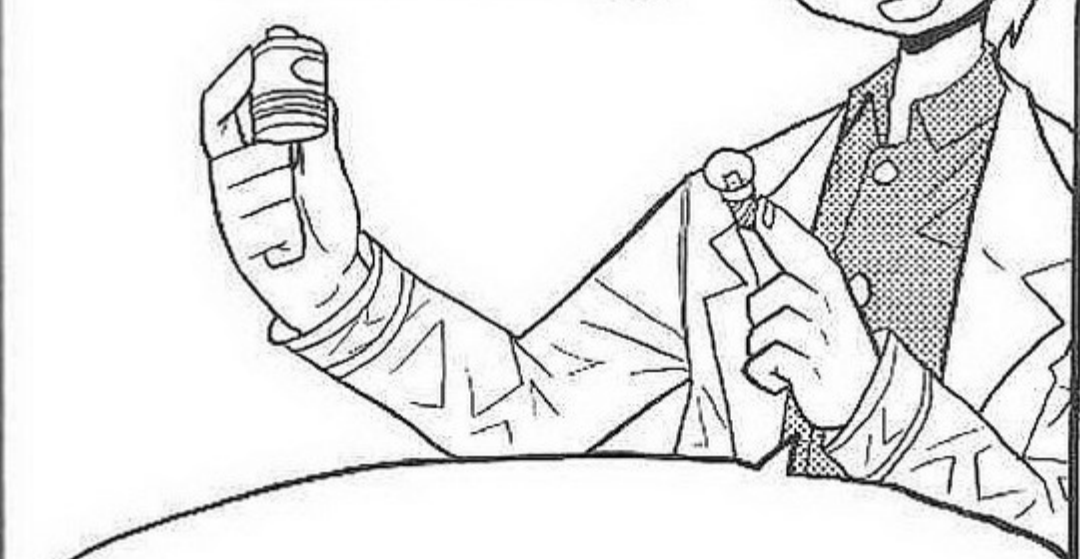

WHEN CURRENT FLOWS, THE *LOAD* CONVERTS ELECTRICAL ENERGY TO LIGHT OR HEAT ENERGY - THAT IS THE WORK THE BATTERY DID ON THE BULB.

I SEE! IN THE FLASHLIGHT, THE LIGHT BULB IS THE *LOAD*, RIGHT?

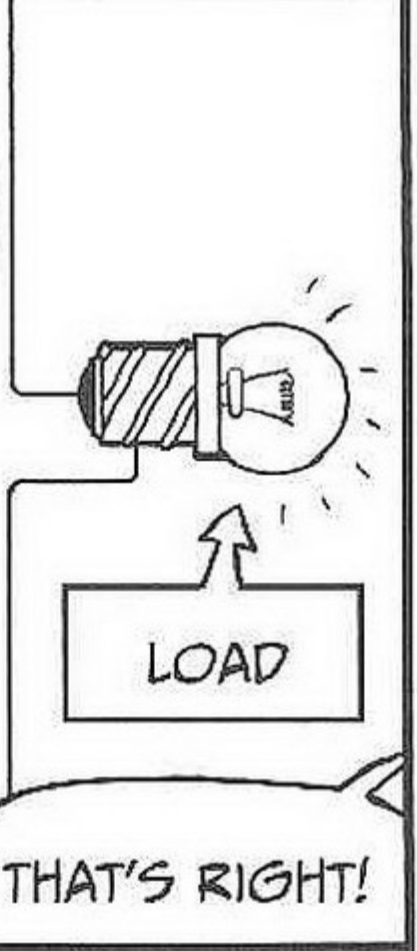
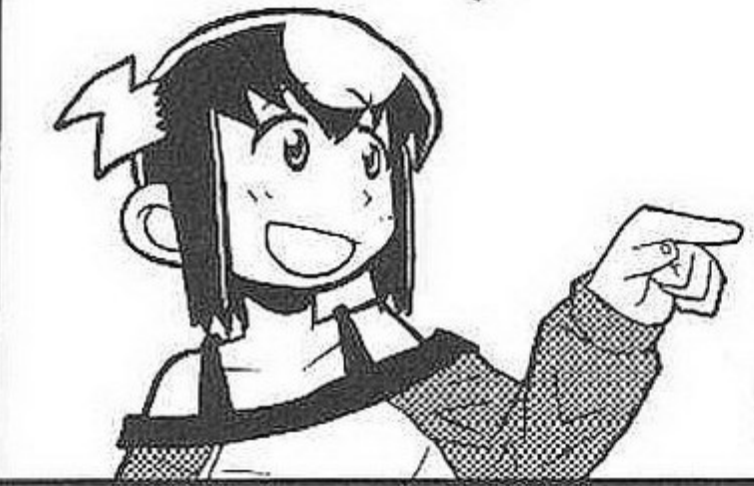

THAT'S RIGHT!

THE *LOAD* ALSO HAS A PROPERTY THAT HINDERS THE FLOW OF CURRENT. THIS IS CALLED *ELECTRIC RESISTANCE*.

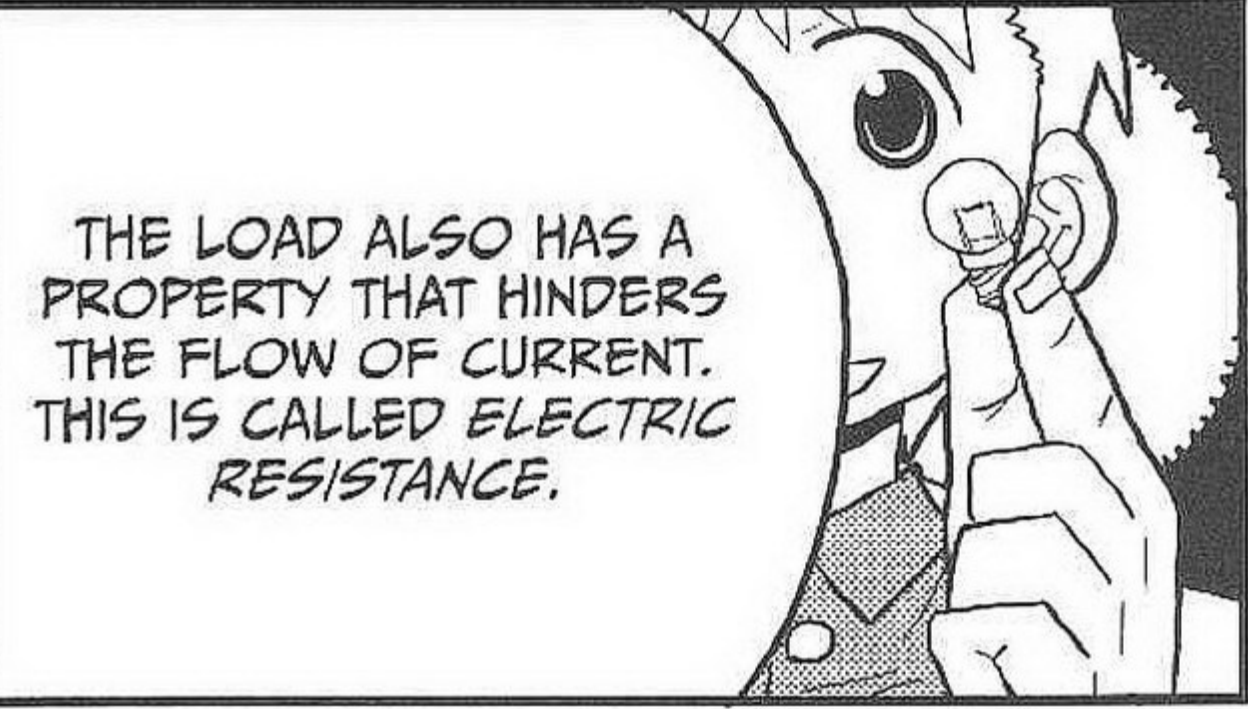

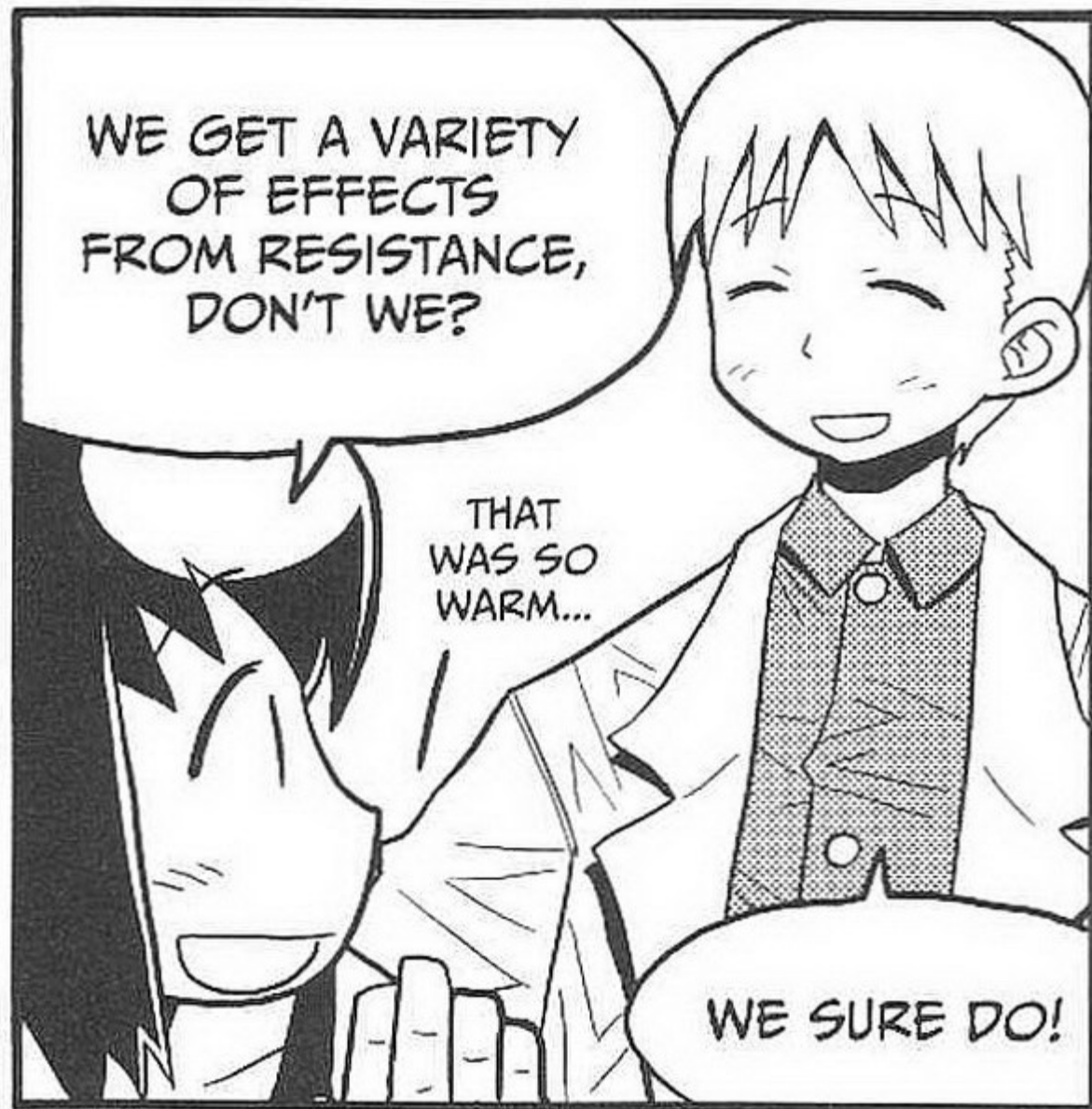
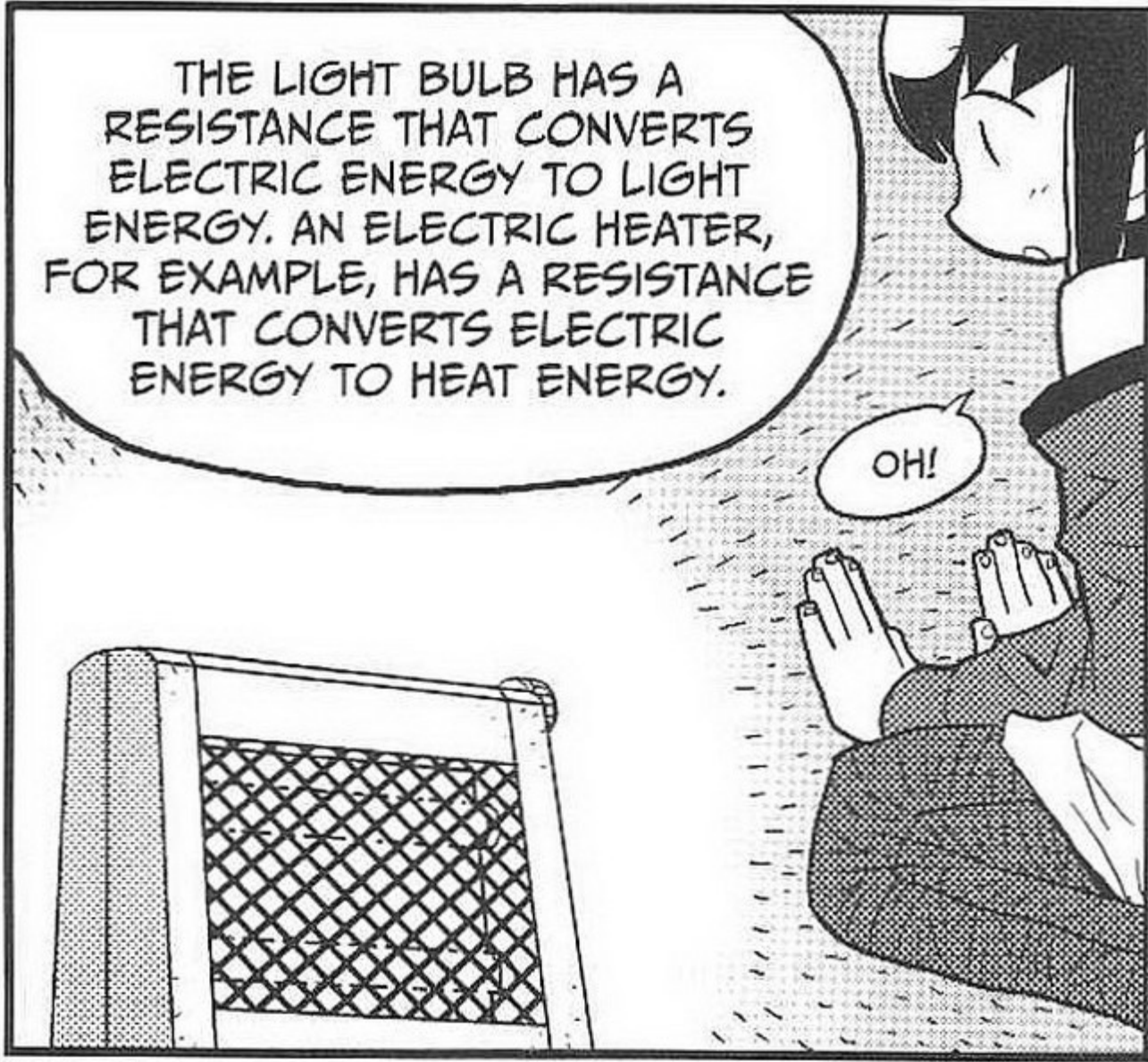
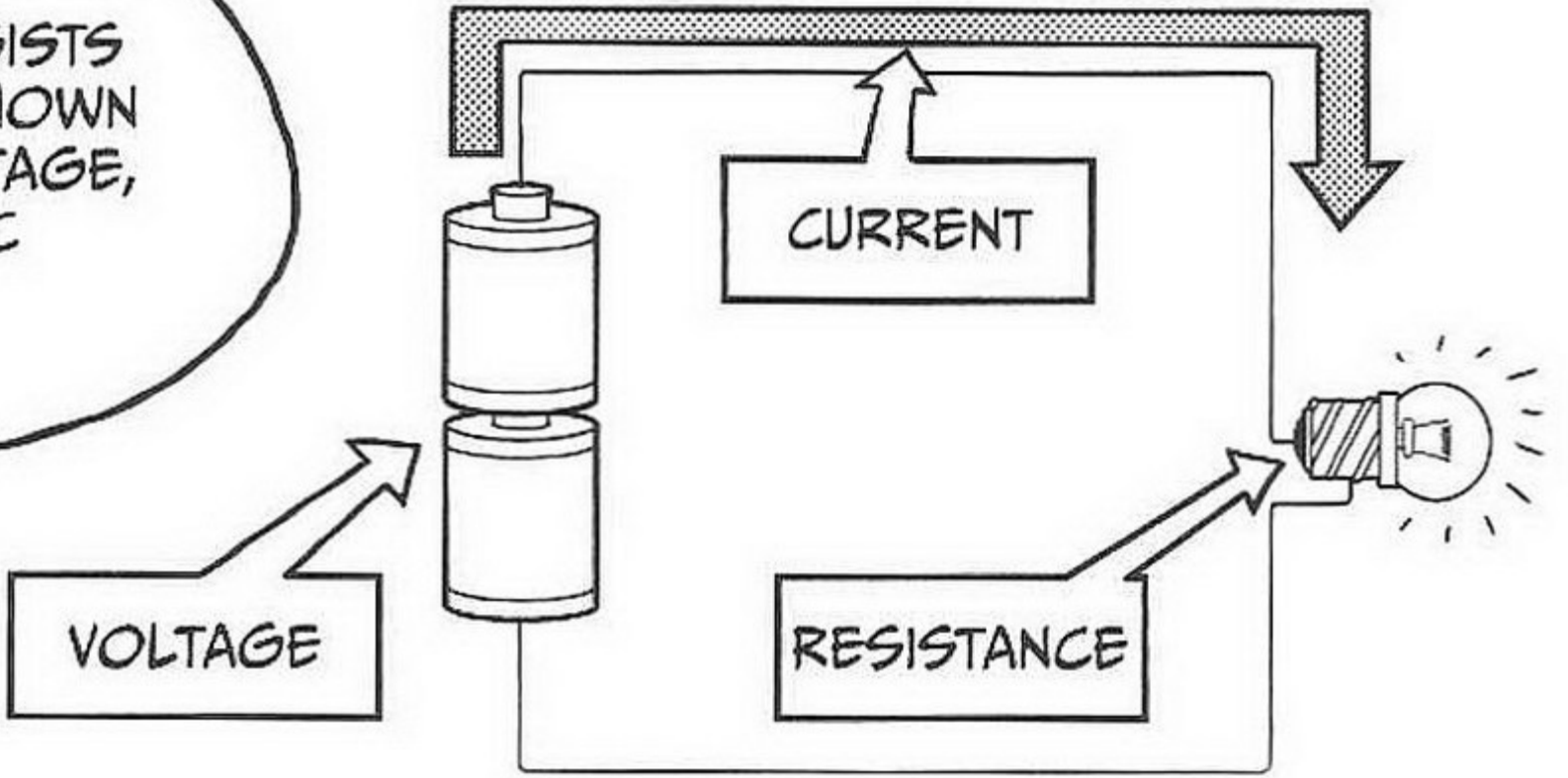
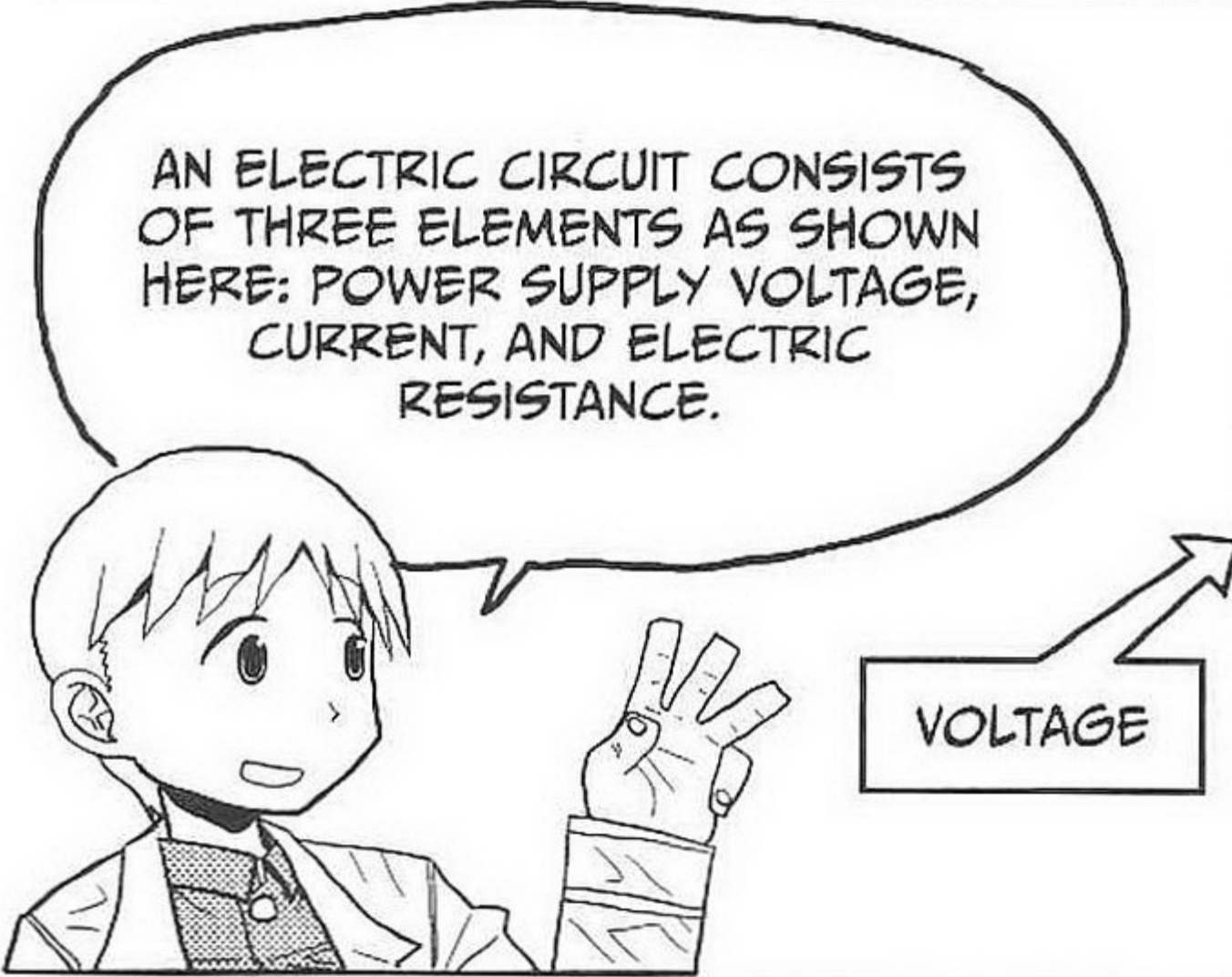
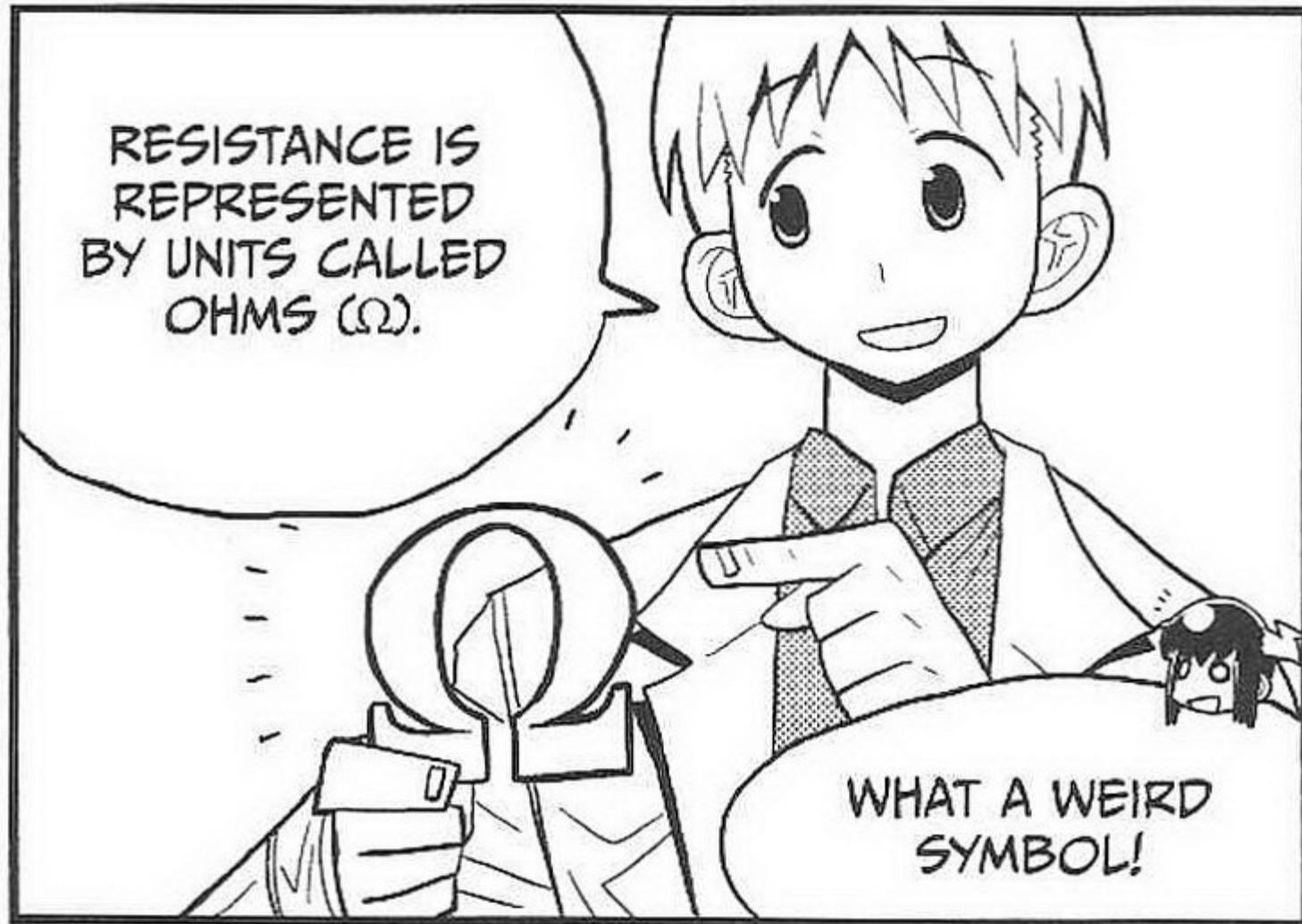
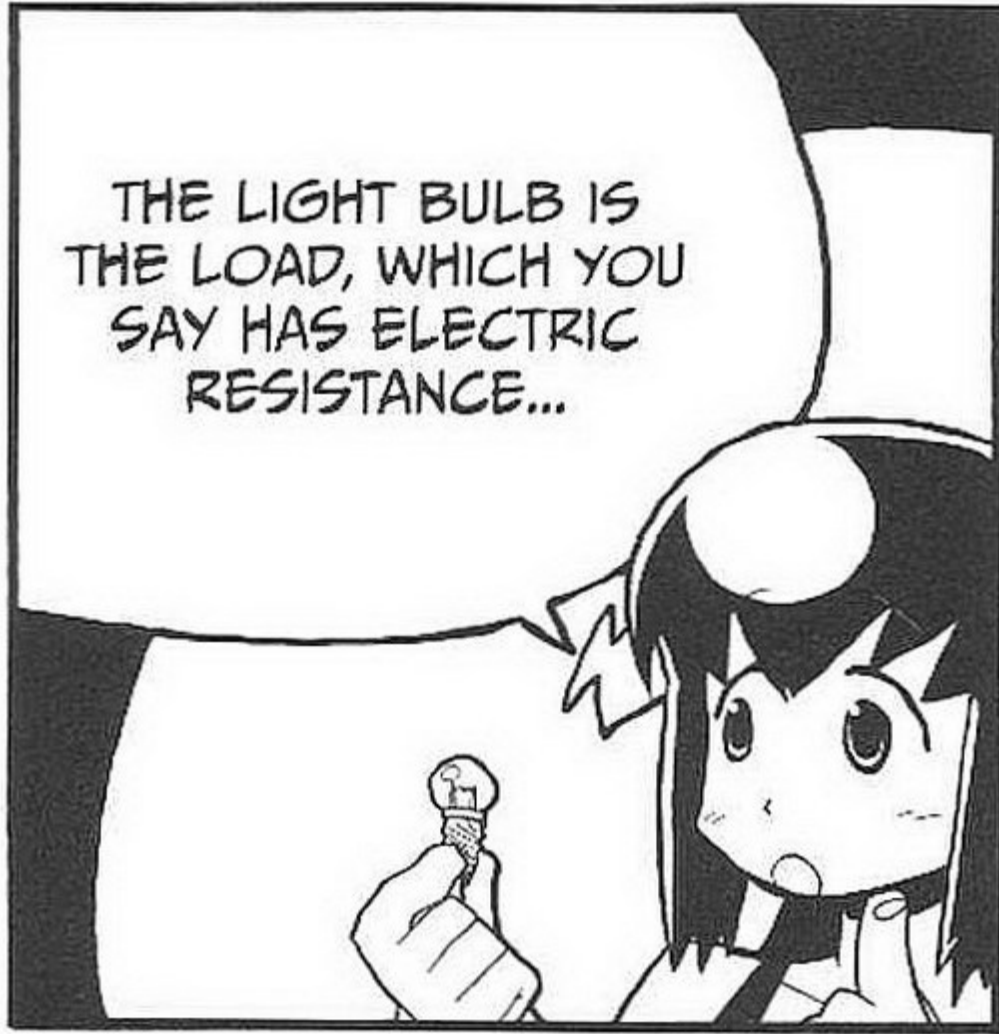

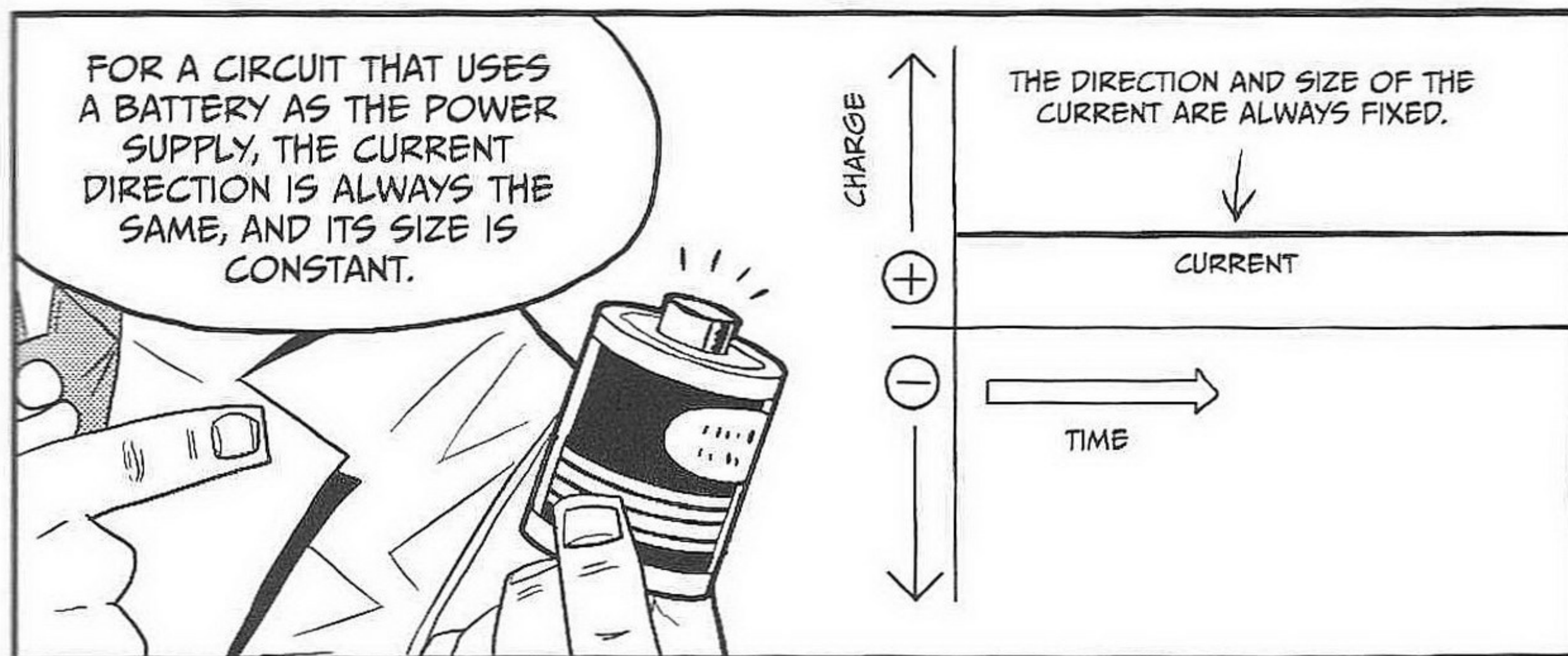
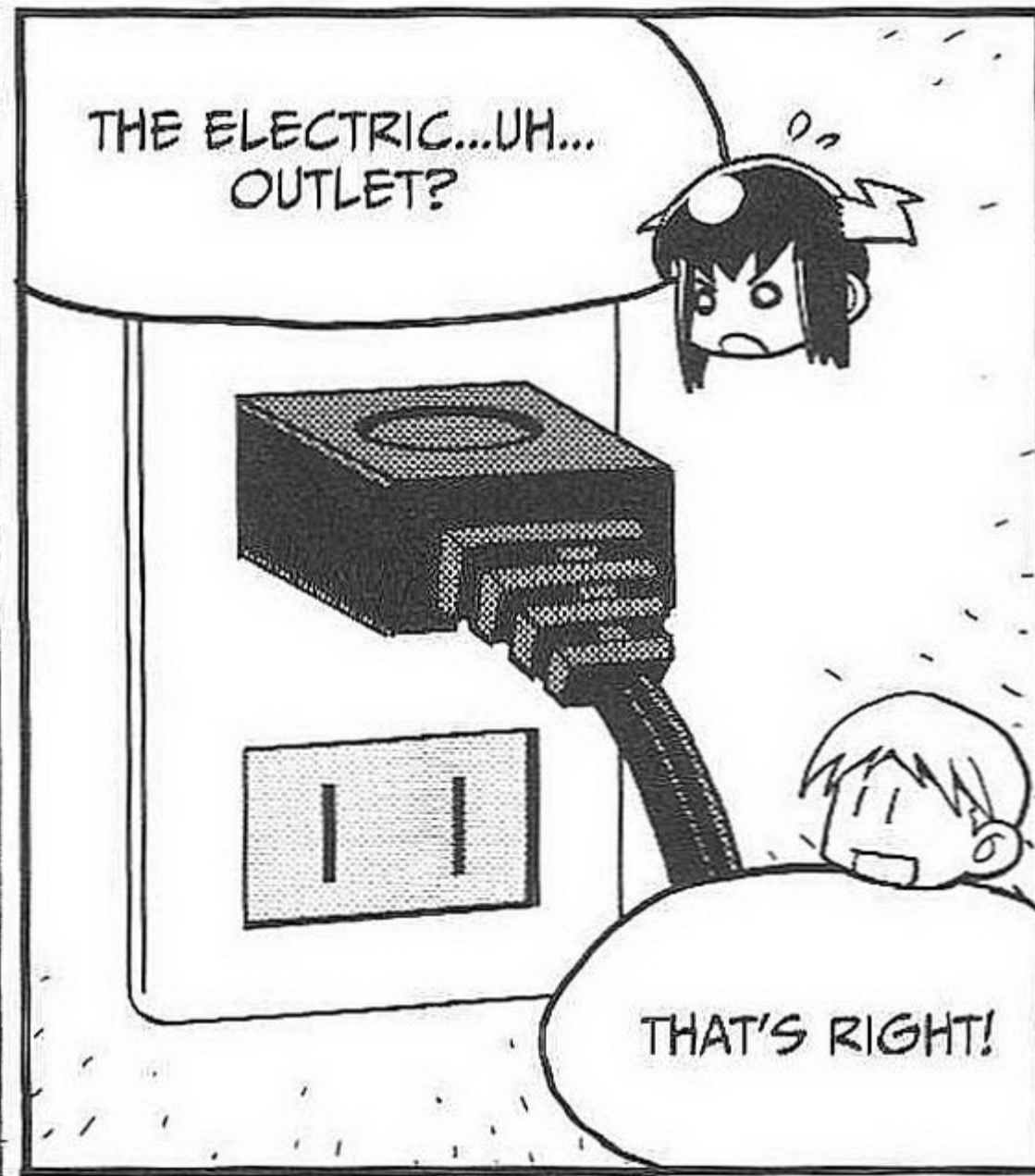

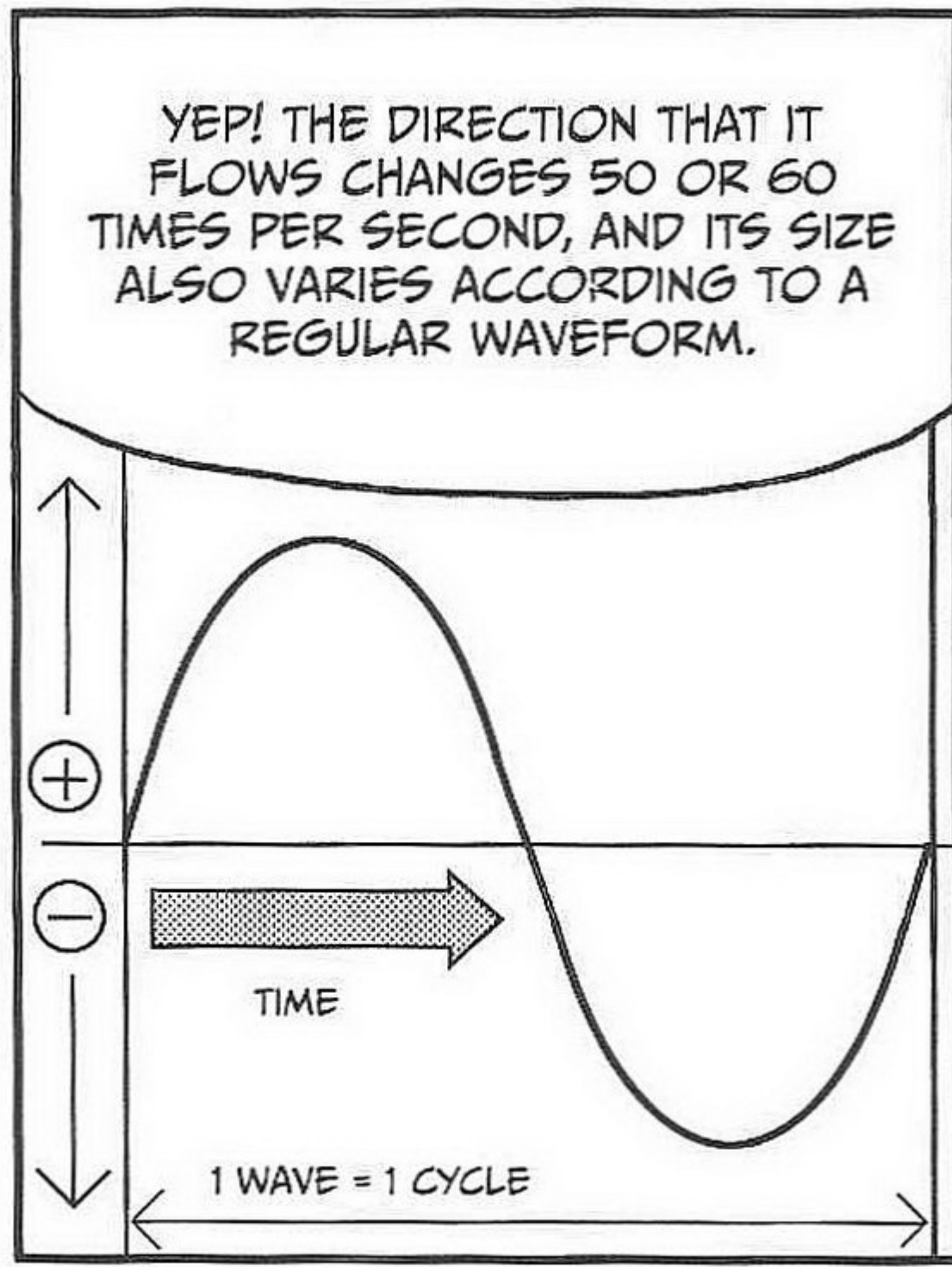
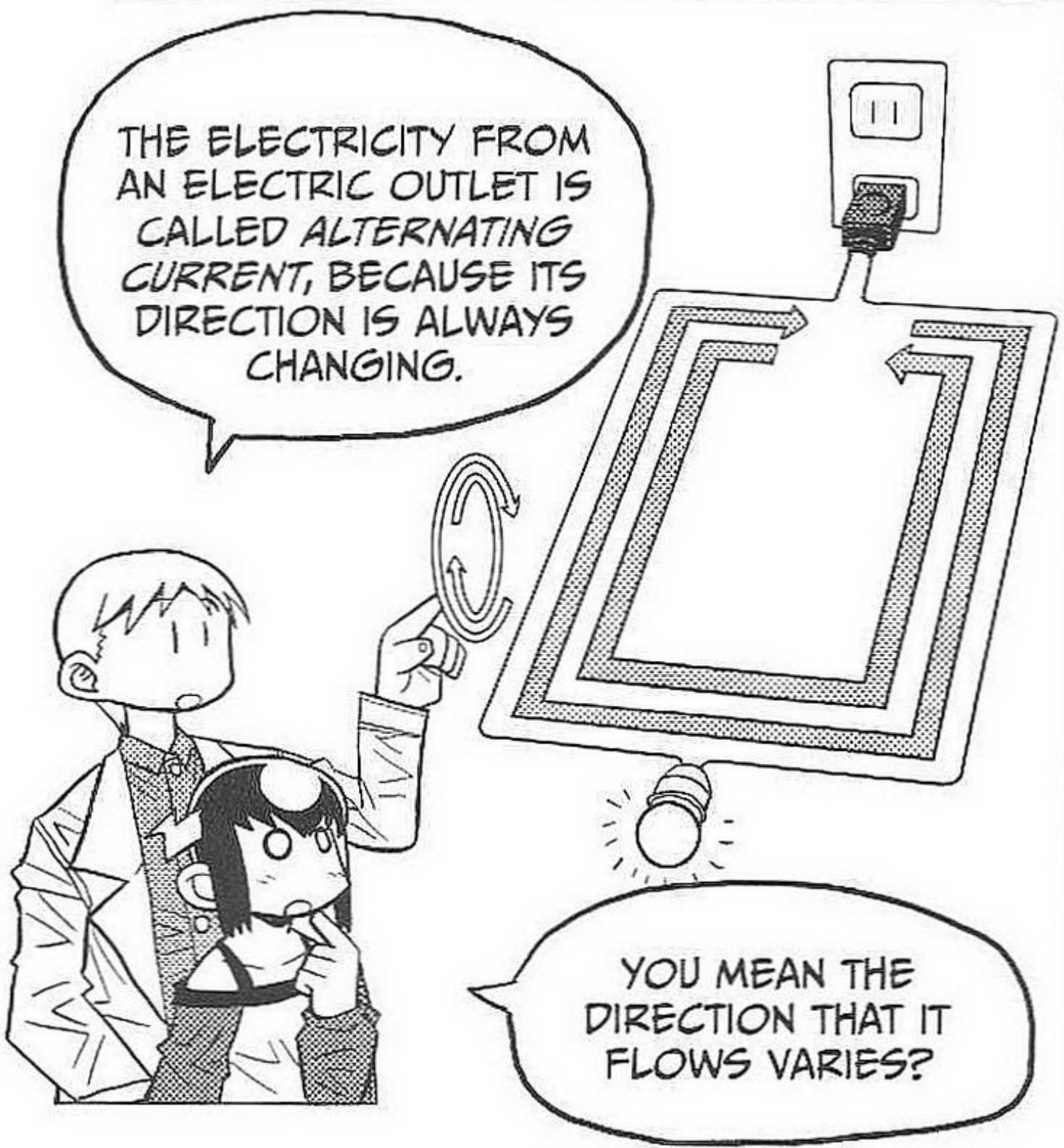
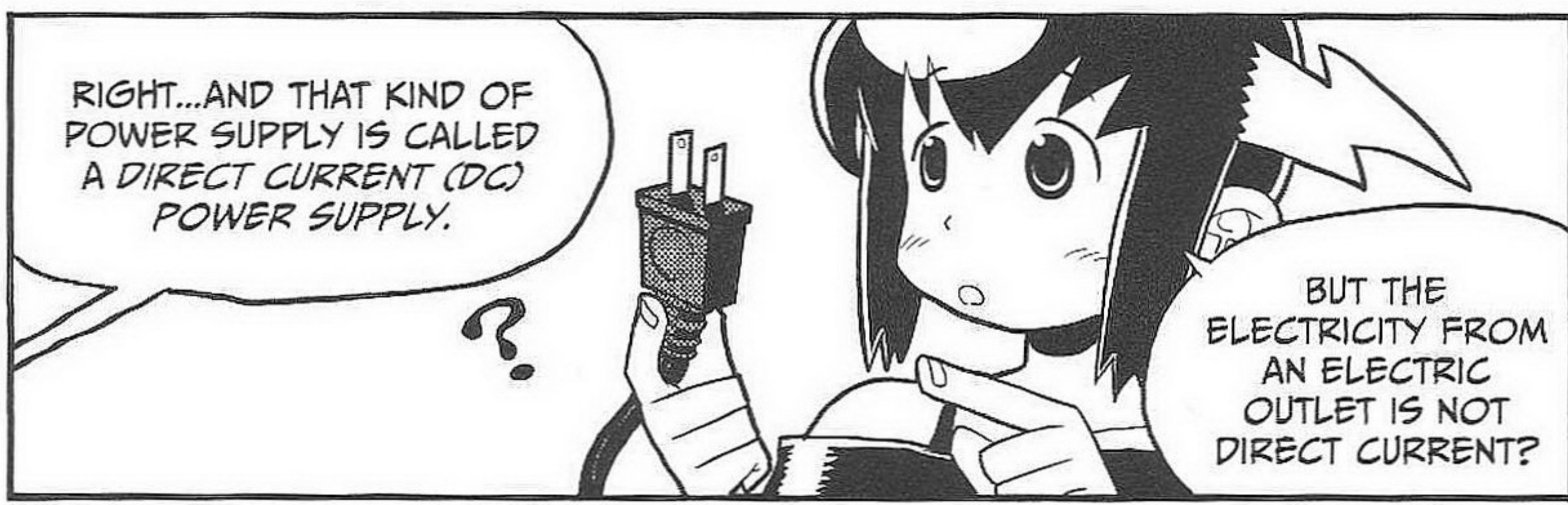

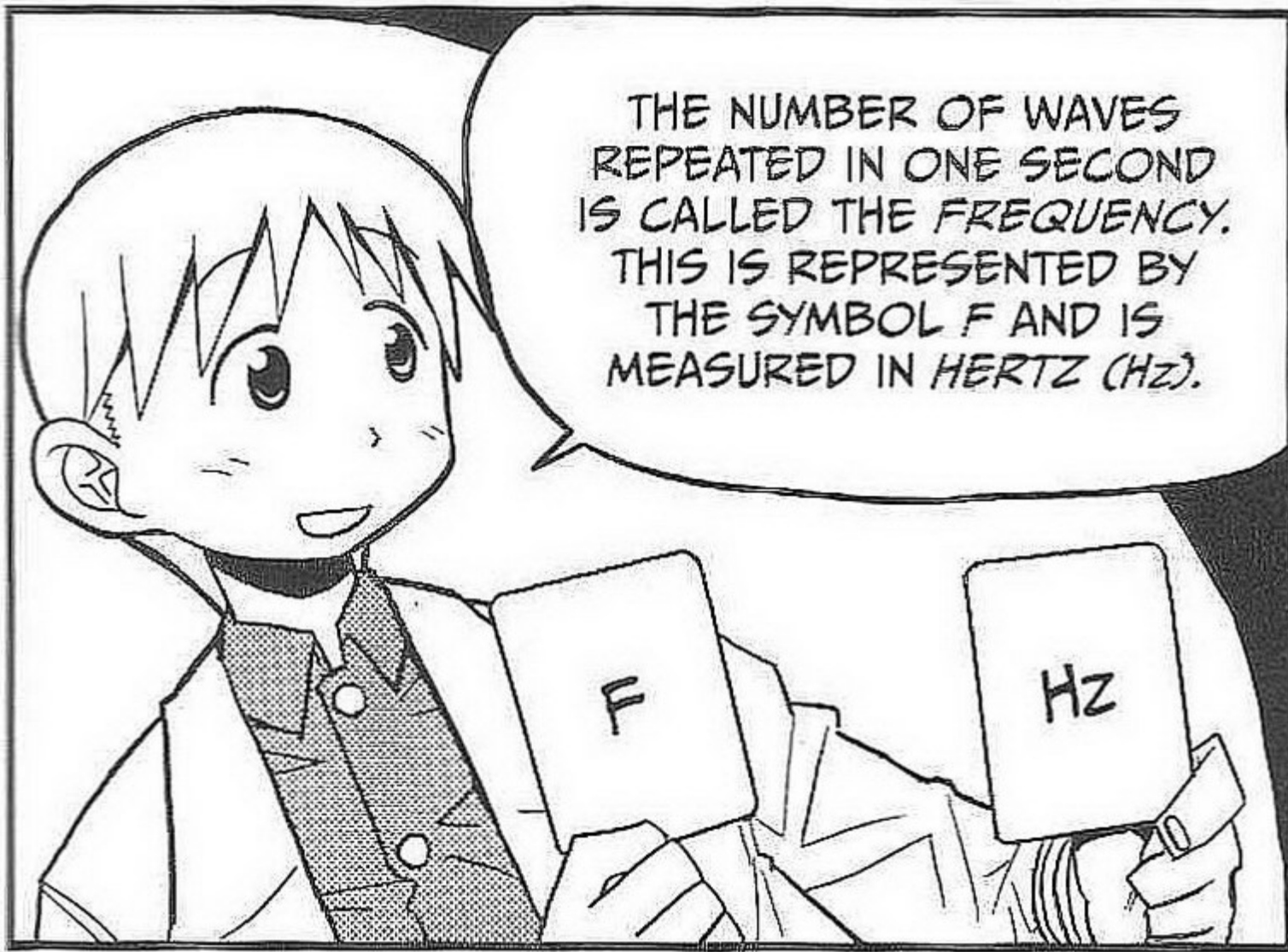

THE NUMBER OF WAVES REPEATED IN ONE SECOND IS CALLED THE FREQUENCY. THIS IS REPRESENTED BY THE SYMBOL F AND IS MEASURED IN HERTZ (Hz).



SO, IF THE DIRECTION THAT THE CURRENT FLOWS CHANGES 50 TIMES PER SECOND, IT'S 50 HERTZ, AND IF IT CHANGES 60 TIMES PER SECOND, IT'S 60 HERTZ?

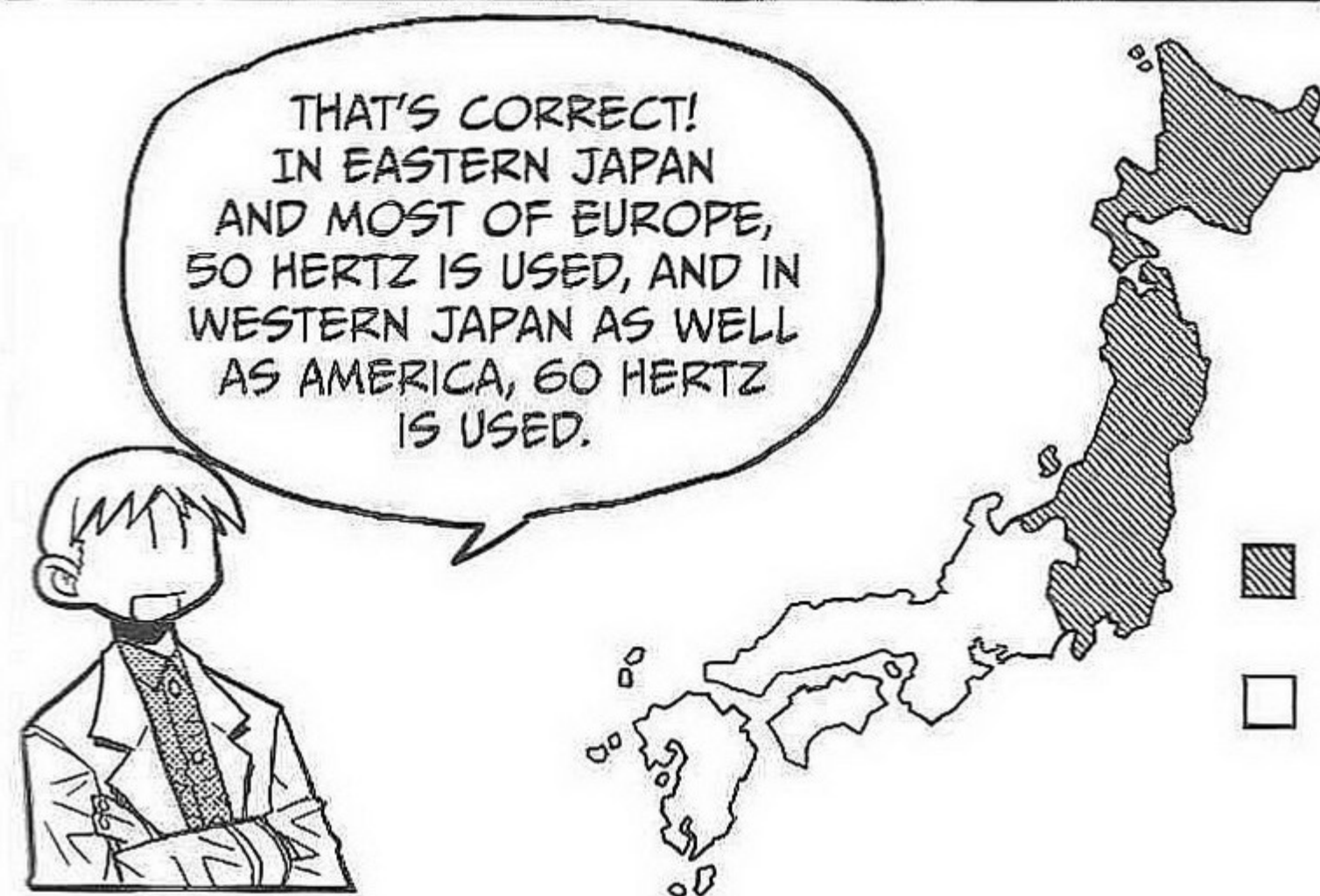

THAT'S CORRECT! IN EASTERN JAPAN AND MOST OF EUROPE, 50 HERTZ IS USED, AND IN WESTERN JAPAN AS WELL AS AMERICA, 60 HERTZ IS USED.

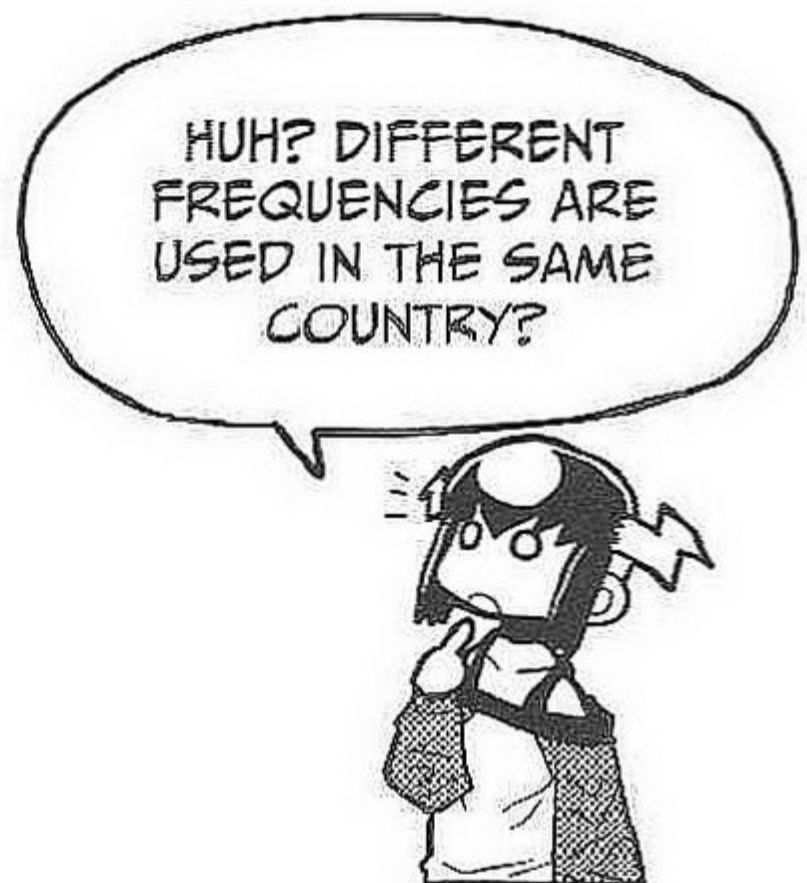

HUH? DIFFERENT FREQUENCIES ARE USED IN THE SAME COUNTRY?

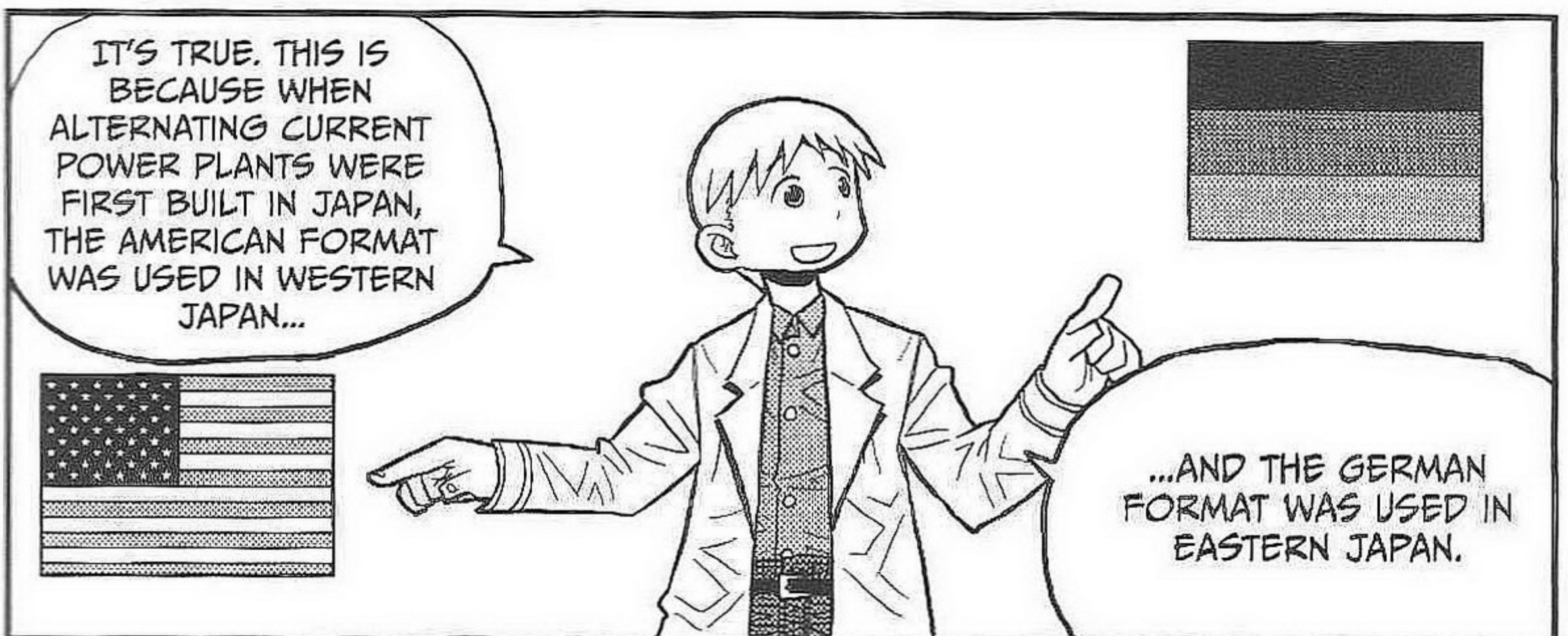

IT'S TRUE. THIS IS BECAUSE WHEN ALTERNATING CURRENT POWER PLANTS WERE FIRST BUILT IN JAPAN, THE AMERICAN FORMAT WAS USED IN WESTERN JAPAN...

...AND THE GERMAN FORMAT WAS USED IN EASTERN JAPAN.

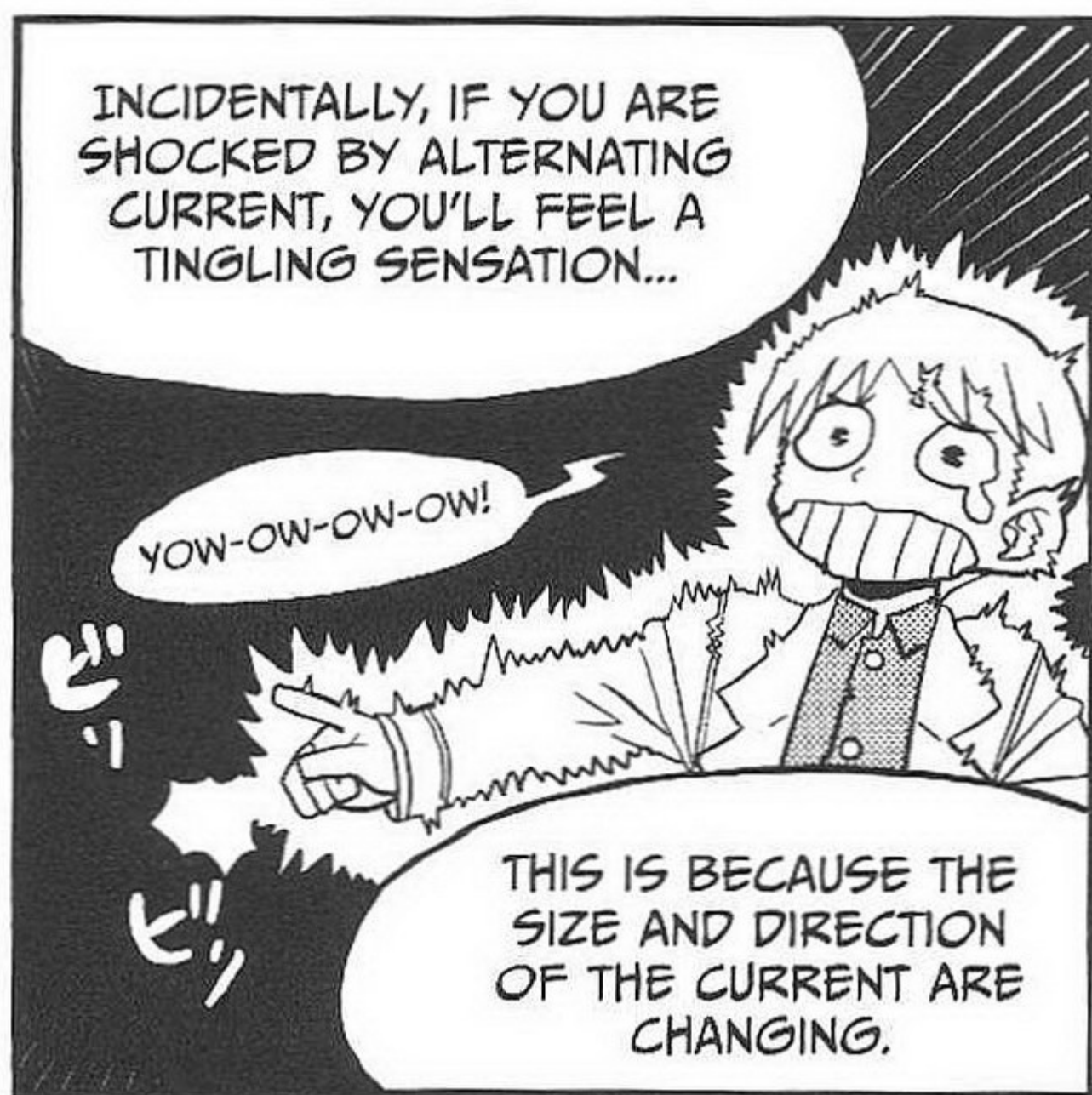

OHM'S LAW AND METHODS OF CONNECTING ELECTRICAL COMPONENTS



WHEN THERE IS A BIG DIFFERENCE IN WATER PRESSURE, THE FORCE OF FLOWING WATER INCREASES AND CAUSES A WATER WHEEL TO ROTATE VIGOROUSLY. WITH ELECTRICITY, THE HIGHER THE VOLTAGE, THE MORE CURRENT WILL FLOW.

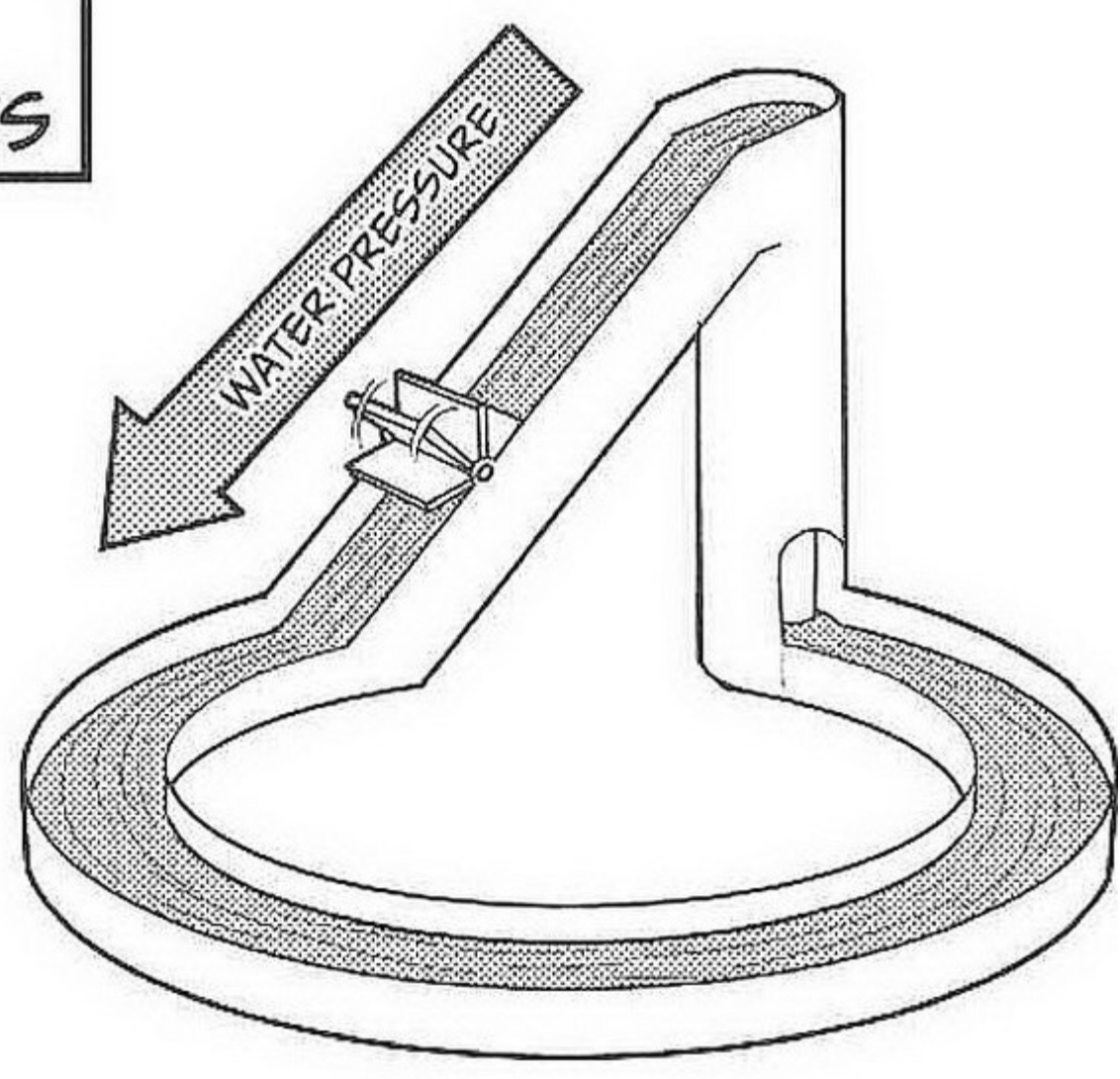

IF THIS WATER WHEEL WERE LARGER, THE WATER FLOW WOULD SLOW DOWN, AND THE QUANTITY OF WATER THAT FLOWS PER SECOND WOULD BE REDUCED, RIGHT?

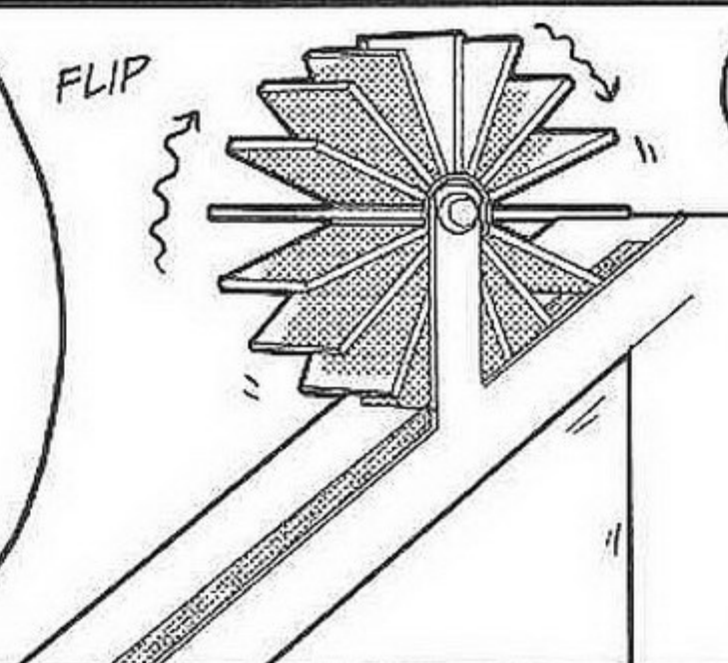

OKAY, RIGHT.

FLIP

IN THE SAME WAY, THE LARGER THE ELECTRIC RESISTANCE, THE MORE THE CURRENT FLOW IS REDUCED.

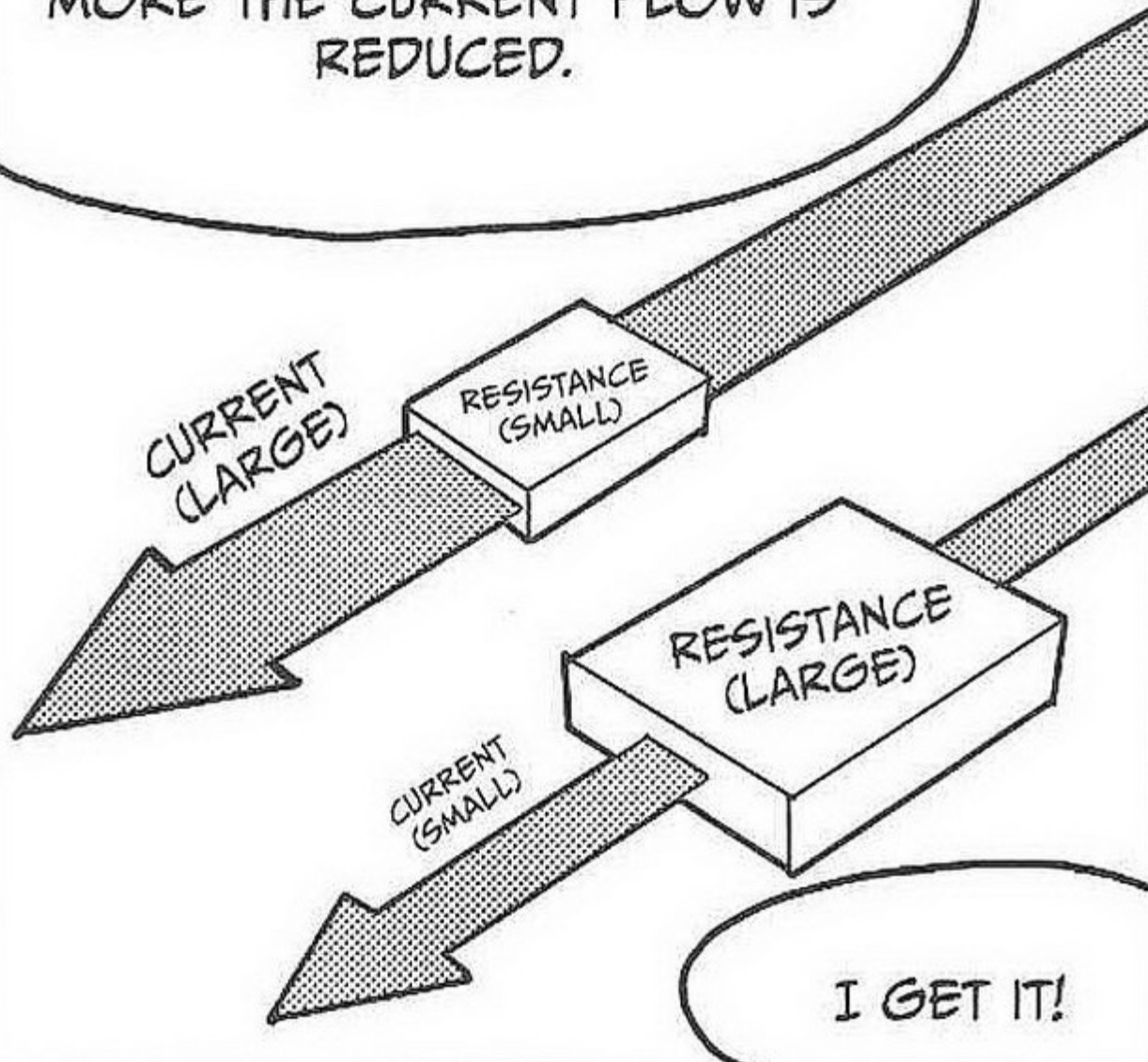

I GET IT!

ELECTRICITY FLOWS ACCORDING TO A CERTAIN LAW.



WHAT LAW IS THAT?

IF CURRENT IS REPRESENTED WITH I (AMPERES),

VOLTAGE IS REPRESENTED WITH V (VOLTS), AND

RESISTANCE IS REPRESENTED WITH R (OHMS),

$$I = \frac{V}{R}$$

THEN THE RELATIONSHIP $I = \frac{V}{R}$ HOLDS.

SEE, THE CURRENT I IS DIRECTLY PROPORTIONAL TO THE VOLTAGE V AND INVERSELY PROPORTIONAL TO THE RESISTANCE R .

I SEE.

THIS IS CALLED OHM'S LAW.

THIS IS THE MOST IMPORTANT AND BASIC PROPERTY IN ELECTRIC CIRCUITS.

GOT IT!

SCRIBBLE, SCRIBBLE

SERIES AND PARALLEL CONNECTIONS

THERE ARE TWO MAIN CONNECTION METHODS USED IN ELECTRIC CIRCUITS.

WHAT ARE THEY?

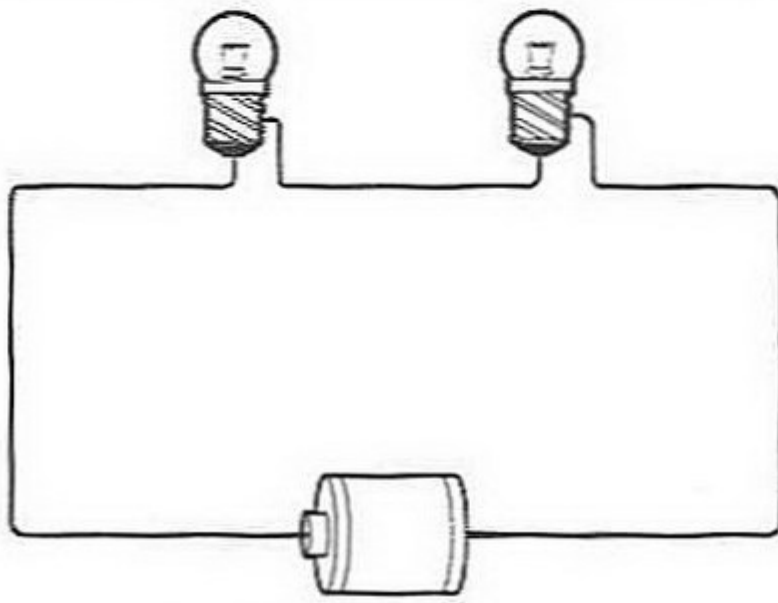

SERIES CONNECTIONS FOR CONNECTING TWO RESISTANCES IN A LINE...

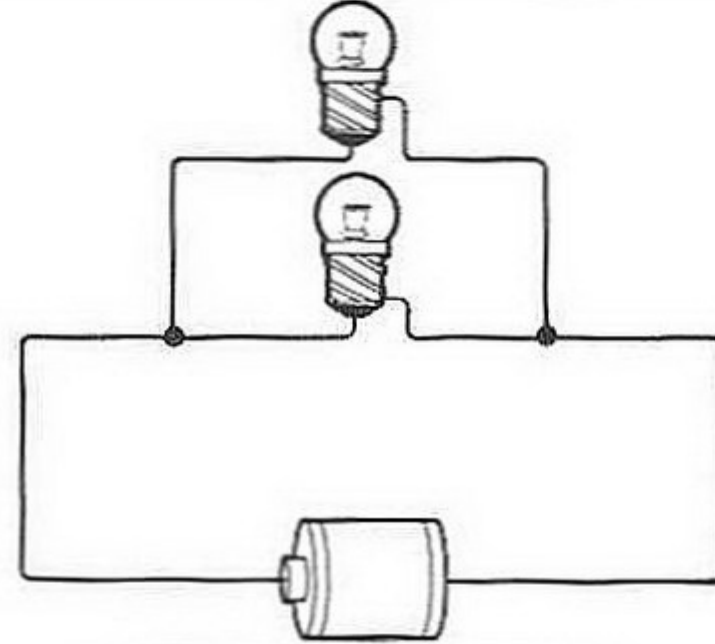

AND PARALLEL CONNECTIONS FOR CONNECTING TWO RESISTANCES SIDE BY SIDE.

HOW DO THEY DIFFER?

THE WAY IN WHICH CURRENT FLOWS AND THE WAY IN WHICH VOLTAGE IS APPLIED BOTH DIFFER.

SERIES CONNECTION

CURRENT FLOWS WITH THE SAME SIZE

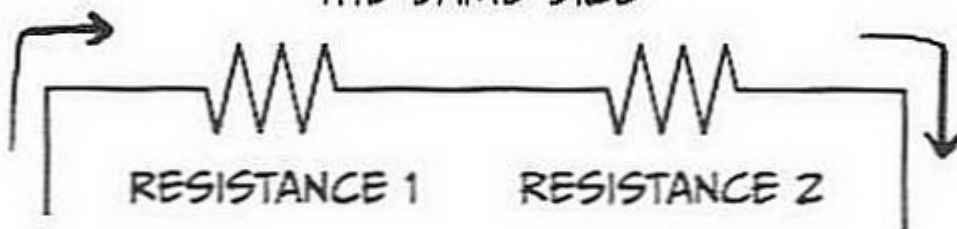

CURRENT OF POWER SUPPLY = CURRENT OF RESISTANCE 1 = CURRENT OF RESISTANCE 2

VOLTAGE OF POWER SUPPLY = VOLTAGE OF RESISTANCE 1 + VOLTAGE OF RESISTANCE 2

PARALLEL CONNECTION

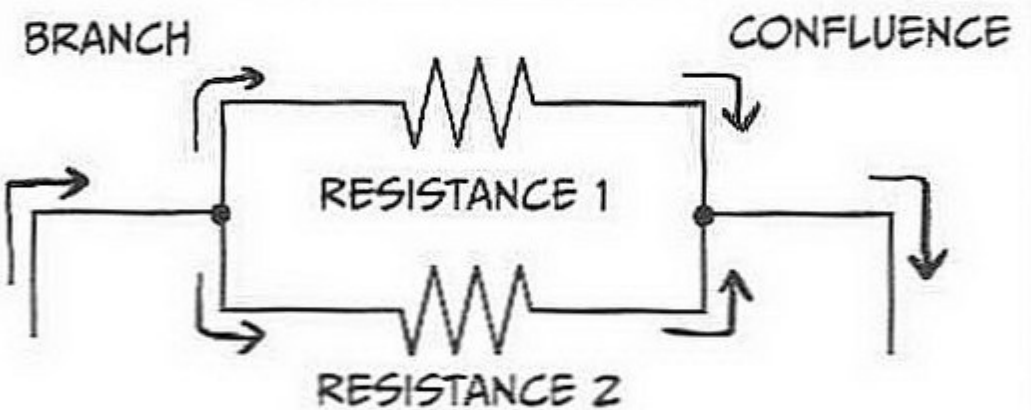

CURRENT OF POWER SUPPLY = CURRENT OF RESISTANCE 1 + CURRENT OF RESISTANCE 2

VOLTAGE OF POWER SUPPLY = VOLTAGE OF RESISTANCE 1 = VOLTAGE OF RESISTANCE 2

WHEN THERE ARE MULTIPLE RESISTANCES IN A CIRCUIT, WE CAN CONSIDER THEM AS A SINGLE EFFECTIVE RESISTANCE.

SO IN THIS CASE, TWO ARE CONSIDERED AS ONE.

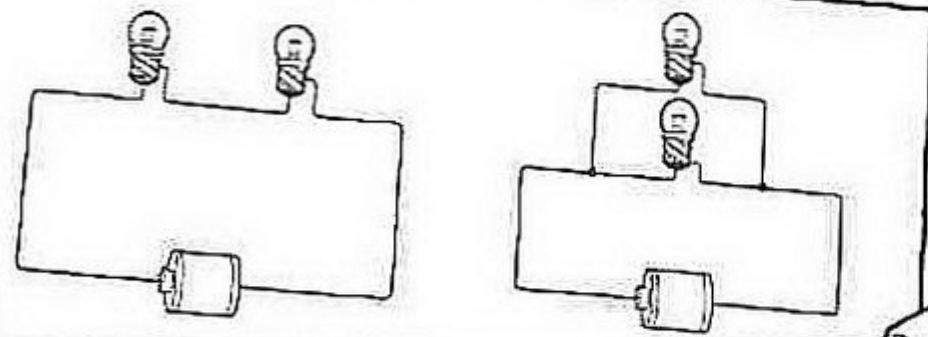

THE EFFECTIVE RESISTANCE IN A SERIES CONNECTION IS OBTAINED BY ADDING THE TWO RESISTANCE VALUES.

$$\text{EFFECTIVE RESISTANCE} = R_1 + R_2$$

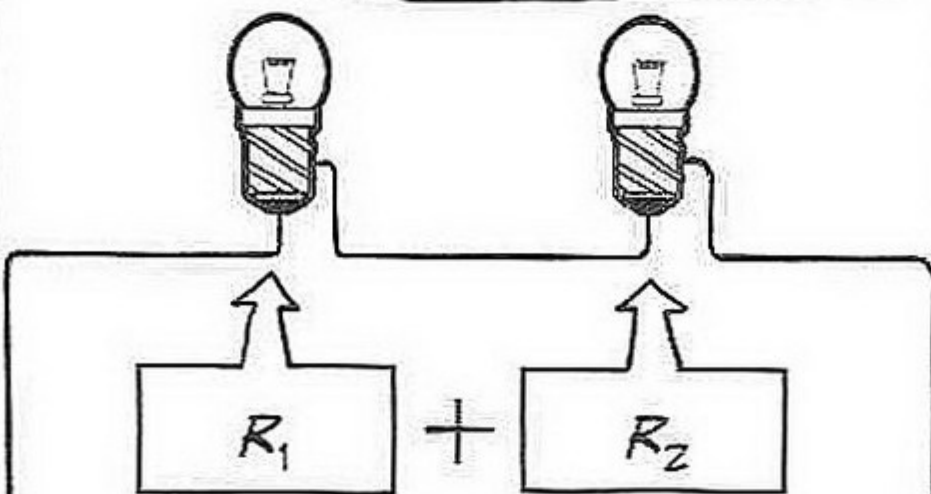

WE SIMPLY ADD THEM LIKE THIS.

HOW ABOUT IN A PARALLEL CONNECTION?

OBTAINING THE EFFECTIVE RESISTANCE IN A PARALLEL CONNECTION IS A LITTLE MORE COMPLICATED.

WE OBTAIN IT LIKE THIS.

SUM OF THE RECIPROCAL OF EACH RESISTANCE

THE SUM OF THE RECIPROCAL?

IF WE REPRESENT IT IN A FORMULA,
IT LOOKS LIKE THIS:

$$\text{EFFECTIVE RESISTANCE} = \frac{1}{\frac{1}{R_1} + \frac{1}{R_2}} = \frac{R_1 \times R_2}{R_1 + R_2}$$

(PRODUCT OVER SUM)



WELL, LET'S GET A
FEEL FOR IT FIRST,
OKAY?

HUFF

OKAY...

IF TWO IDENTICAL
LIGHT BULBS ARE
CONNECTED IN SERIES,
THE RESISTANCE VALUE
IS DOUBLED, RIGHT?

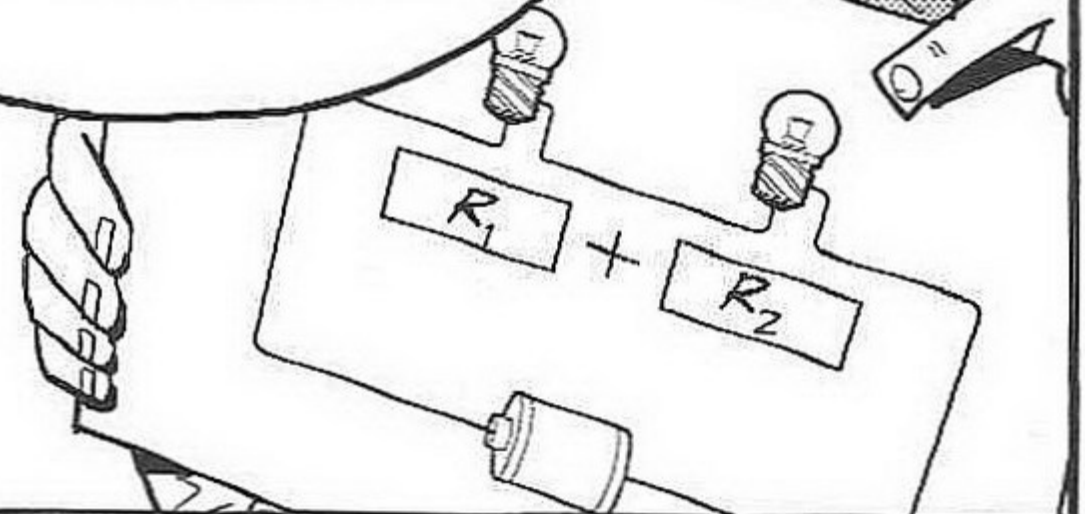

1 BULB



BRIGHT

2 BULBS

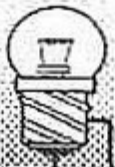

DIM

IN THIS CASE, SINCE THE
CURRENT IS HALVED, THE
BRIGHTNESS OF EACH BULB IS
DIMMER THAN WHEN JUST ONE
BULB IS CONNECTED.

TO GET THE SAME
BRIGHTNESS IN BOTH
BULBS AS WHEN ONE
BULB IS CONNECTED,
WE MUST DOUBLE
THE VOLTAGE.

CLICK

IF WE CONNECT THE BULBS IN PARALLEL, THE SAME VOLTAGE IS APPLIED TO EACH BULB, AND SINCE THE SAME CURRENT IS FLOWING, THE BRIGHTNESS DOES NOT CHANGE. HOWEVER, THE TOTAL CURRENT IS DOUBLED.

EVEN THOUGH THE CURRENT BRANCHES, THE CURRENT FLOWING TO A SINGLE BULB IS THE SAME.

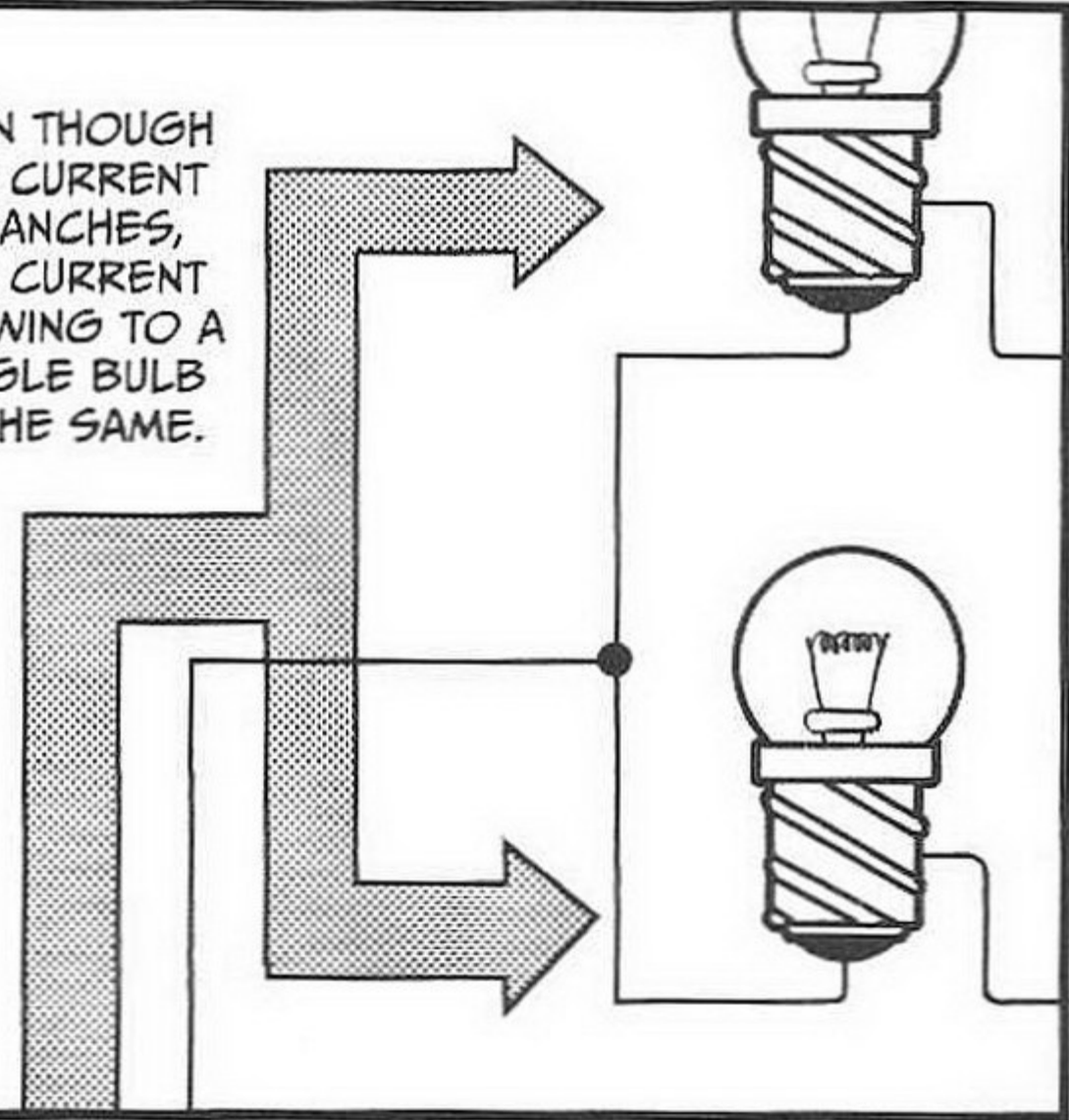

IN OTHER WORDS, WE NEED A POWER SUPPLY THAT MAKES TWICE AS MUCH CURRENT FLOW.

THESE CONNECTION METHODS EACH HAVE SPECIAL CHARACTERISTICS, DON'T THEY?

A HOUSEHOLD ELECTRIC APPLIANCE ALSO ACTS AS A RESISTANCE. WE CAN CONNECT MANY OF THEM IN PARALLEL TO A 120V POWER SUPPLY FROM THE BREAKER.

THEREFORE, A VOLTAGE OF 120V IS APPLIED TO EVERY ELECTRIC APPLIANCE.

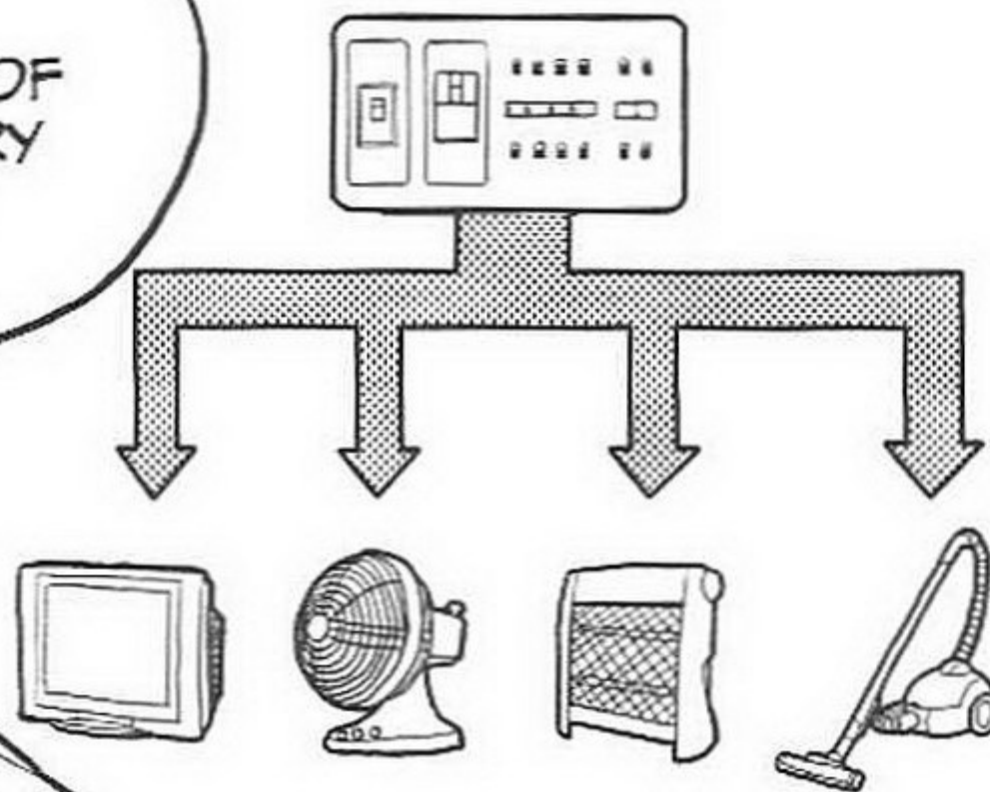

I GET IT!

ALL 120V

ELECTRIC CIRCUITS AND CURRENT

The electrical parts that make up a flashlight are the batteries, a miniature light bulb, and a switch. A battery has the ability to make electrical current flow, so it is called the *power supply*. The light bulb is a part that emits light when current flows through it. The switch is a part that lets electricity flow or stops it according to the opening and closing of a contact.

When the switch is closed, current leaves the positive pole of the battery, passes through the light bulb and switch, and returns to the negative pole. The path through which current flows in this way is called an *electric circuit*, which always has a closed form (a *closed circuit*).

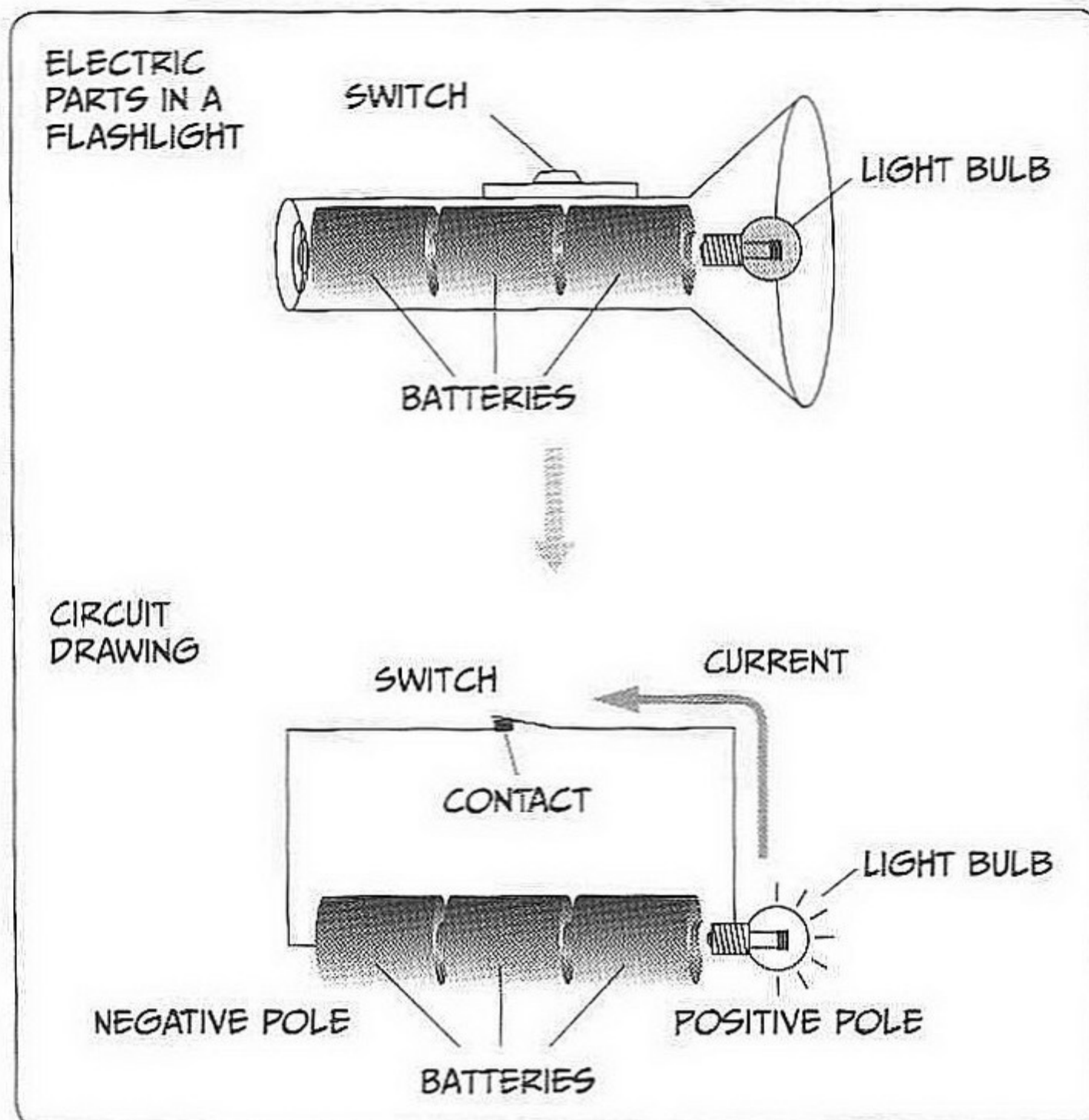

Electric circuit of a flashlight

GRAPHICAL SYMBOLS

A basic electric circuit consists of three elements: power supply voltage, current, and electric resistance. These elements are connected by electric wires.

The power supply voltage that does the work of making current flow is called the *electromotive force*. The element that converts electric energy to light or heat when current flows is called the *load* (loads can also convert electrical energy into other things like sound or motion). The load has a property that hinders the flow of current, and this is called *electric resistance* or simply *resistance*. Resistance is represented by the symbol R and measured in *ohms* (Ω), which come from the name of the German physicist Georg Simon Ohm.

Creating a realistic drawing of an electric circuit takes time and effort. Therefore, *graphical symbols* are generally used to draw a representation. Using standard graphical symbols enables anyone to easily understand a circuit diagram that was drawn by someone else.

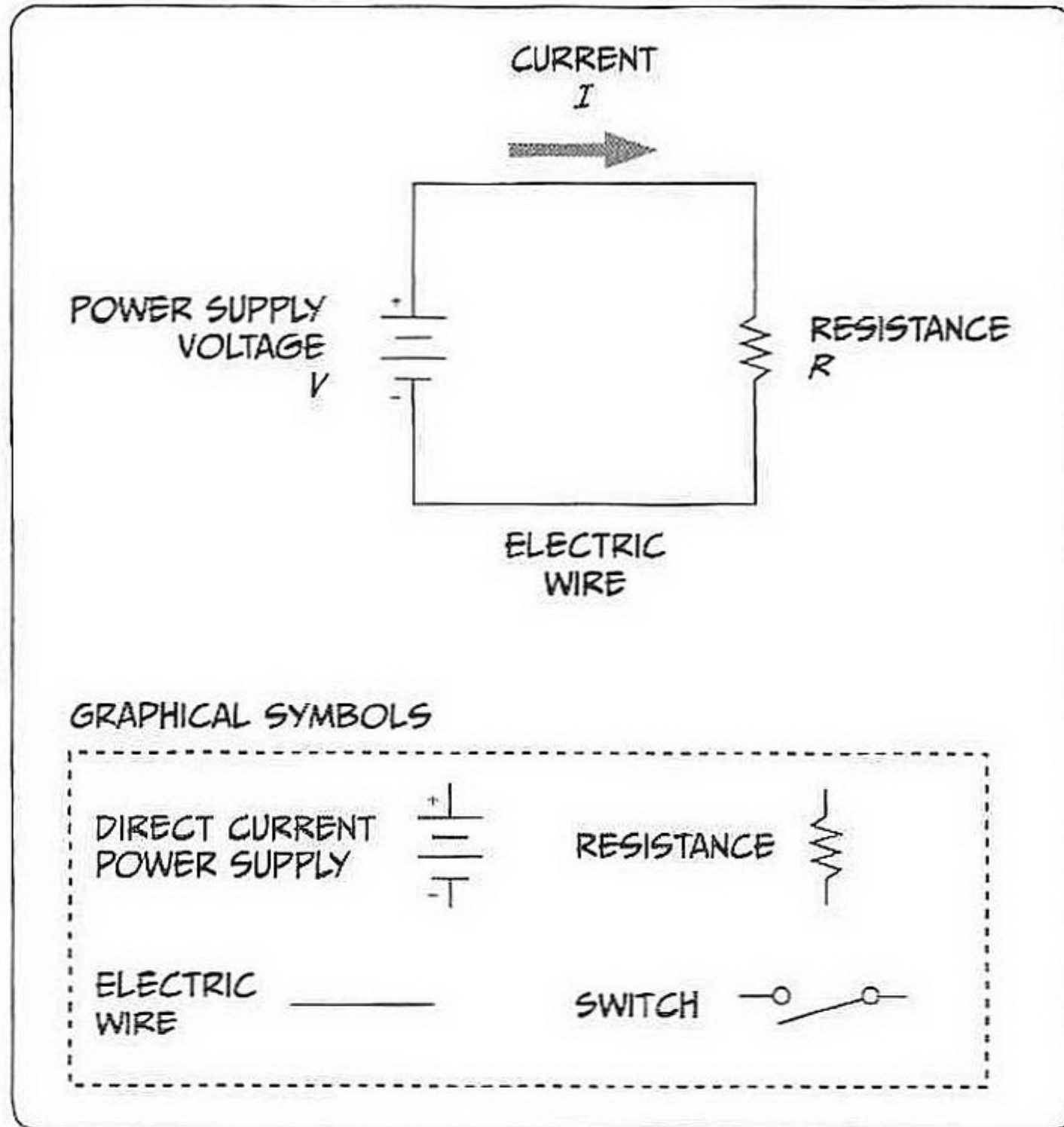

Electric circuit and graphical symbols

Appliances that use electric resistance include electric heaters and toasters. The electric heating element used in these appliances is the part that converts electrical energy to heat energy when current flows through the electric resistance. Note that the electric wire used in these appliances also has electric resistance; although it is only a small amount of resistance, when current flows through the electric wire, heat is generated.

DIRECT CURRENT CIRCUIT AND ALTERNATING CURRENT CIRCUIT

The direction the current flows in a circuit that has a battery as the power supply is fixed, and the size of the current is also constant. When the direction of the flow of current and the size of the current are fixed, we call the electricity *direct current (DC)*. A circuit in which direct current flows is called a *direct current (DC) circuit*. A power supply that sends out direct current, such as a battery, is called a *DC power supply*. A size D or size AA battery has a DC 1.5V power supply voltage.

THE DIRECTION OF CURRENT IS ALWAYS THE SAME, AND THE SIZE IS ALSO CONSTANT.

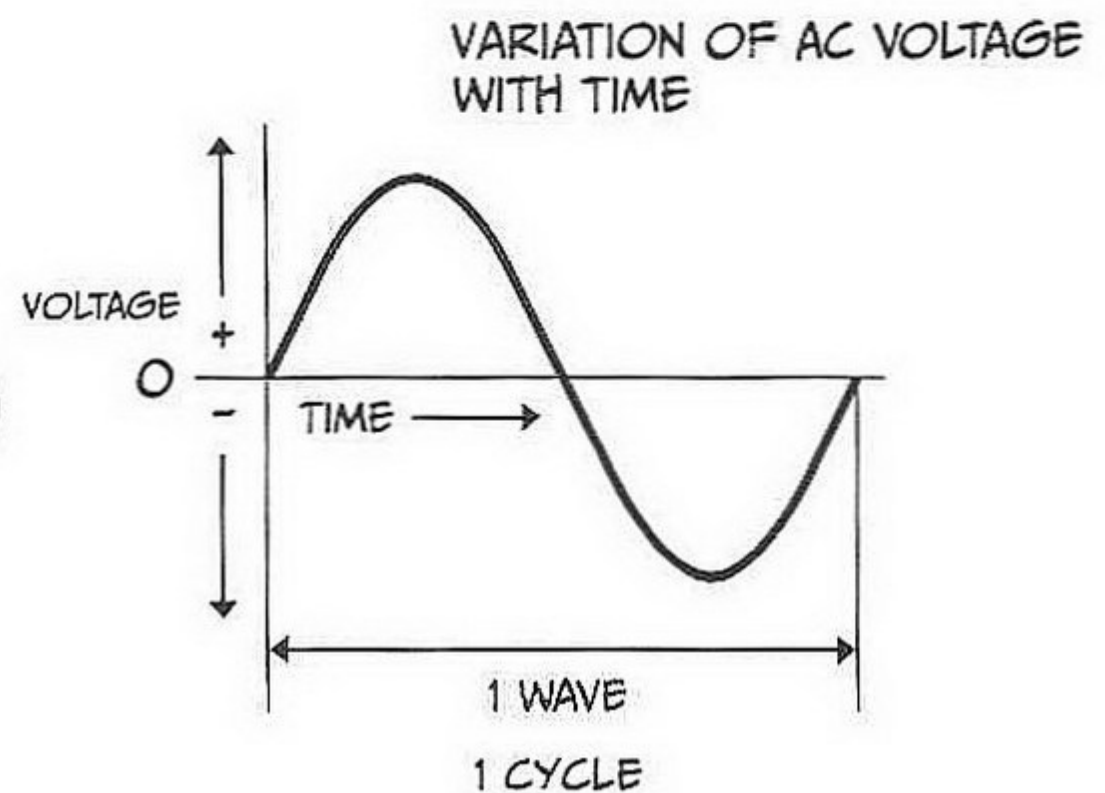
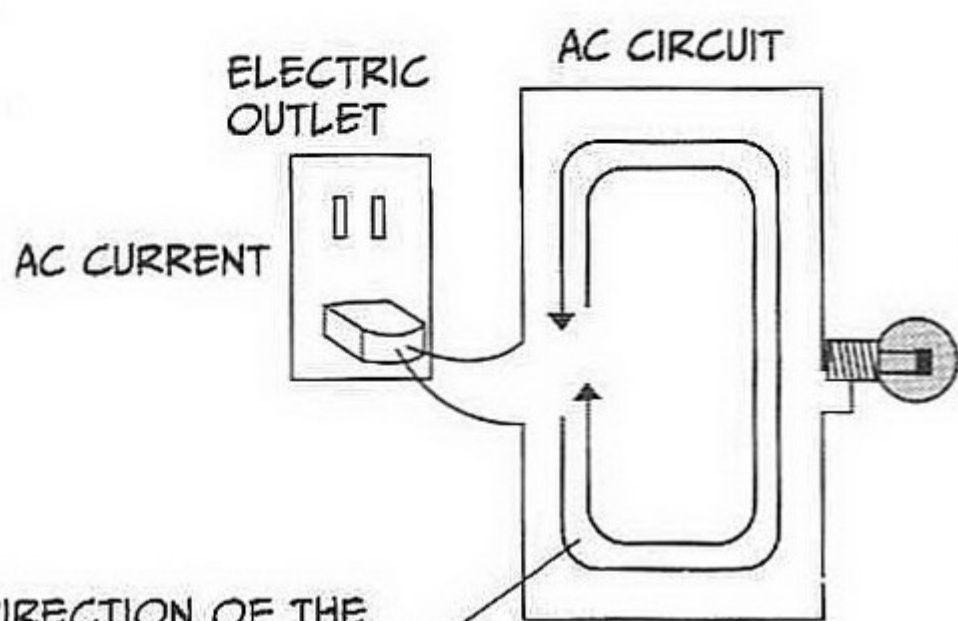
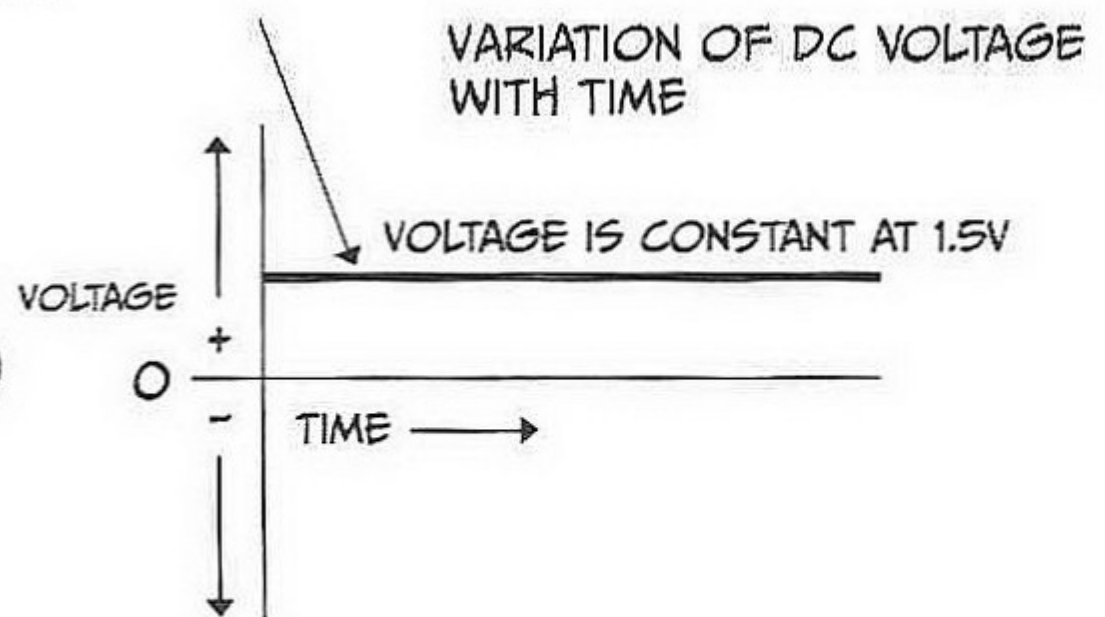
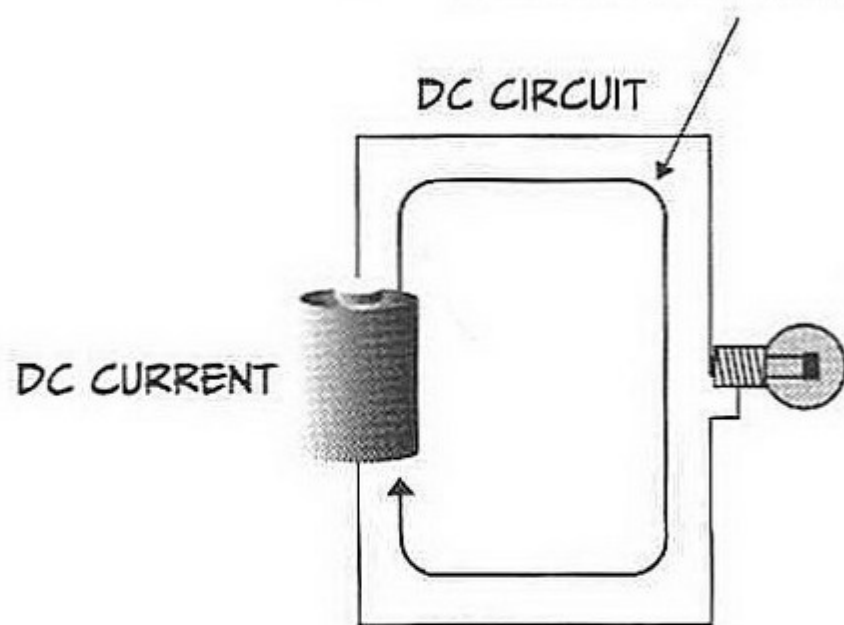

THE DIRECTION OF THE CURRENT ALTERNATES BETWEEN CLOCKWISE AND COUNTERCLOCKWISE.

THE NUMBER OF WAVES REPEATED IN ONE SECOND IS CALLED THE FREQUENCY.

Direct current and alternating current

On the other hand, the direction of flow and size of the current sent from the electric power company to a home changes cyclically. This kind of electricity is called *alternating current (AC)*, and a circuit in which alternating current flows is called an *alternating current (AC) circuit*. The direction that this electricity flows changes 50 or 60 times per second, and its size also varies cyclically with time. The number of waves repeated in one second is called the *frequency*, which is represented by f and measured in *hertz (Hz)*.

The size of AC voltage at any given time is called the *instantaneous voltage*, and the largest value among the instantaneous voltages is called the *peak voltage*. The size of the AC voltage that will perform the same amount of work as a DC voltage is called the *effective voltage*. The AC voltage that comes to an electric outlet in a home is generally 120V in the United States, but this is the effective voltage. The peak voltage is approximately 170V.

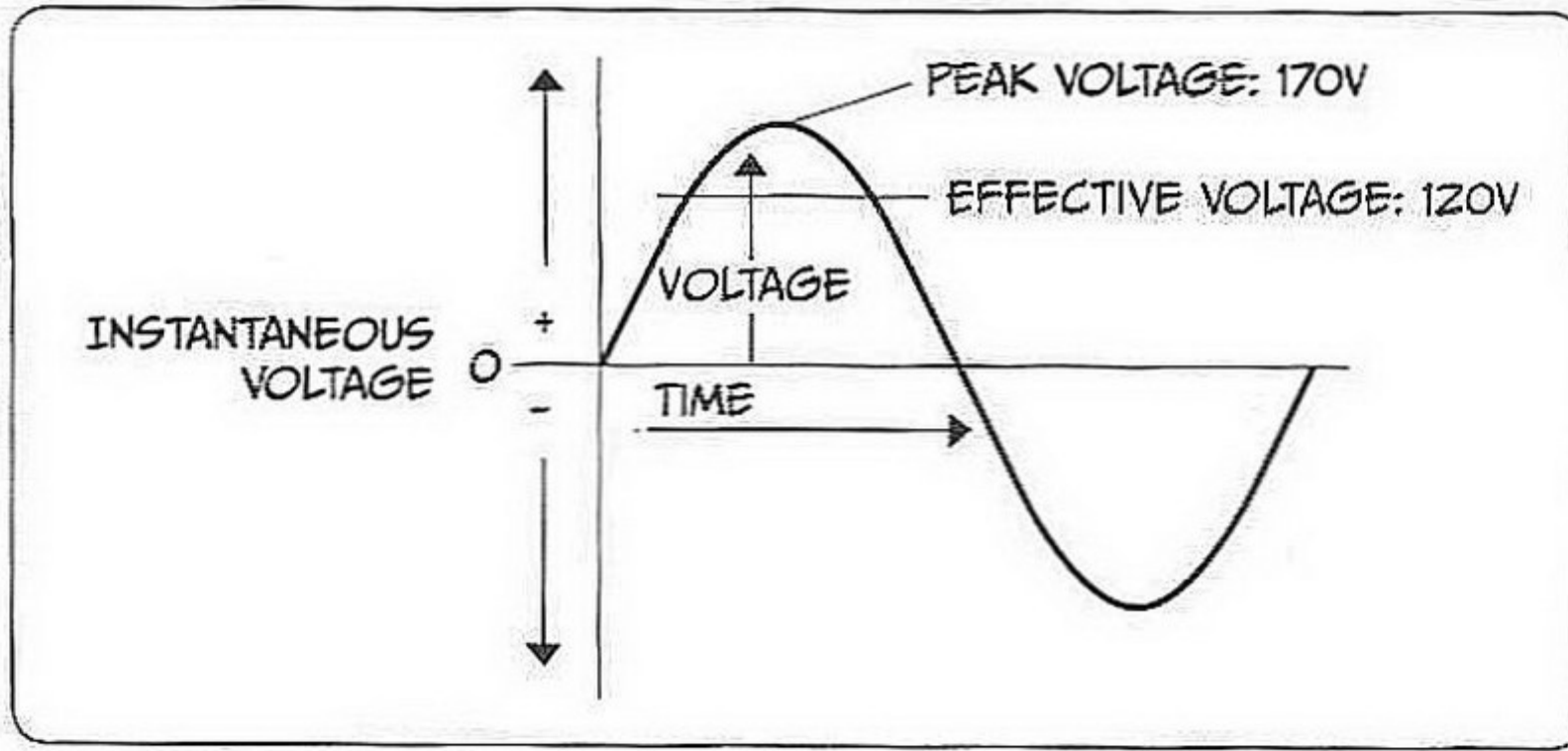

Alternating current value

OHM'S LAW

The current that flows in a circuit is directly proportional to the voltage and indirectly proportional to the resistance. This relationship is called *Ohm's law* and can be expressed in a formula as $I = V / R$. This is the most important and basic property in electric circuits.

For example, if a voltage of 120V is applied to a resistance of 120Ω , the current will be $I = V / R = 120 / 120$, and 1A of current will flow. Whenever you know two values among the current, voltage, and resistance in a circuit, you can use Ohm's law to calculate the value you don't know.

OHM'S LAW $I = \frac{V}{R}$

IF THESE TWO VALUES ARE KNOWN,
THE CURRENT CAN BE CALCULATED.

CALCULATION
ACCORDING
TO OHM'S LAW

$$I = \frac{V}{R} = \frac{120}{120} = 1A$$

Ohm's law

RESISTIVITY AND CONDUCTIVITY

Electric wire has a very low resistance and is used to connect circuit elements. When a small amount of current flows through wire, we can consider its resistance negligible. If a larger amount of current flows through a wire than can do so safely, heat will be generated.

Resistance (R) is a measure indicating the difficulty of the flow of current. The resistance (measured in ohms) of a conductor with length L meters and cross-sectional area A square meters can be represented by $R = \rho \times L / A$.

Resistivity measures how much a material opposes the flow of current and can be used to determine a wire's resistance. Resistivity, represented by the symbol ρ , is a material-specific resistance value and is measured in *ohm meters* (Ωm). From this equation it is apparent that for the same material, the size of the resistance is directly proportional to the length and inversely proportional to the cross-sectional area.

RESISTIVITY (IN Ωm) OF VARIOUS METALS AT ROOM TEMPERATURE (68°F)

| | |
|----------|------------------------|
| Gold | 2.22×10^{-8} |
| Silver | 1.59×10^{-8} |
| Copper | 1.69×10^{-8} |
| Aluminum | 2.27×10^{-8} |
| Nichrome | 107.5×10^{-8} |

Conductance (G), in contrast to resistance, is a measure indicating the ease of the flow of current and is measured in *siemens (S)*. Conductivity, represented by the symbol σ , is the reciprocal of resistivity, and it is measured in *siemens per meter (S/m)*. (The siemens, named for German inventor Ernst Werner von Siemens, is an inverse ohm; it is also sometimes called a *mho* and can be represented by the symbol \mathcal{O} or Ω^{-1}).

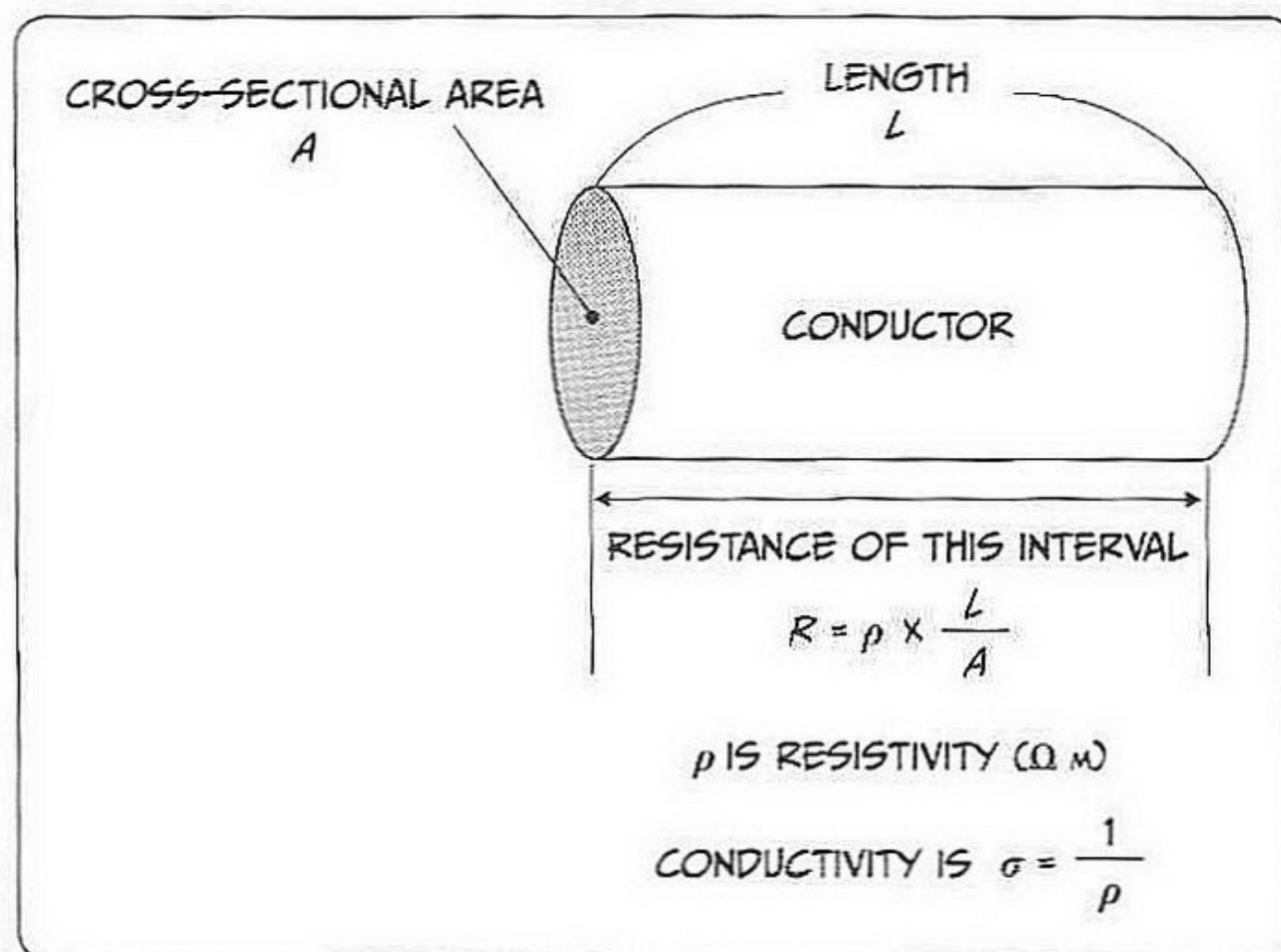

Resistivity and conductivity

EFFECTIVE RESISTANCE

There are two basic methods of connecting electrical components. Let's look at them both with respect to resistance. When there are multiple resistances in a circuit, we can consider them as a single *effective resistance*.

The method of connecting resistances in a line is called a *series connection*. We calculate the value of the effective resistance in a series connection by totaling the individual resistance values.

$$\text{Effective resistance} = R_0 = R_1 + R_2 + \dots + R_n$$

In this connection, the size of the current that flows in each resistance is the same. The power supply voltage is voltage divided by each resistance.

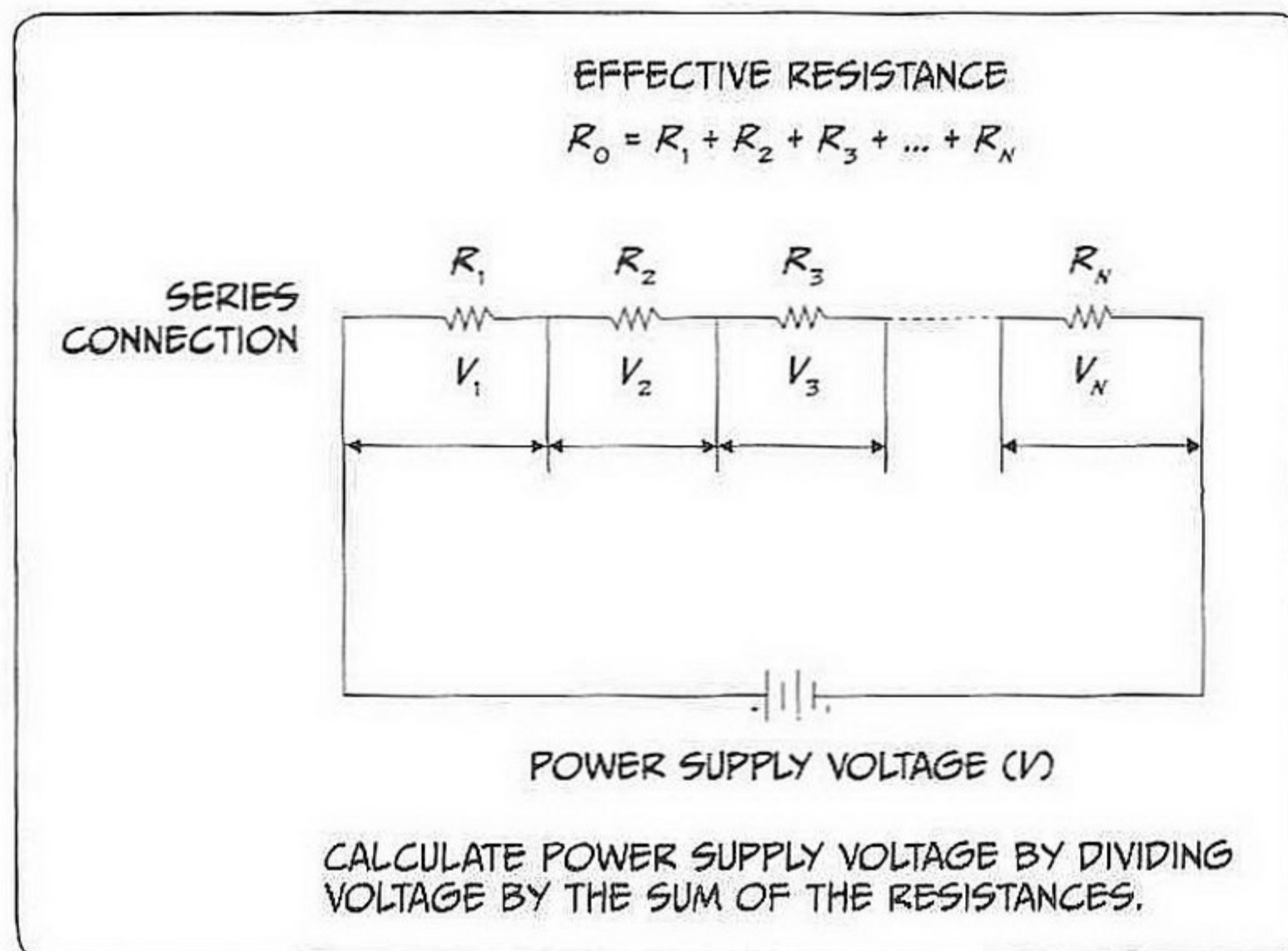

Series connection and effective resistance

If two light bulbs of the same size are connected in series to a power supply, the current will be halved, and the brightness of each bulb will be dimmer than it was when just a single bulb was connected, because the effective resistance is doubled. At this time, the voltage at both sides of each light bulb will be half the value of the power supply voltage.

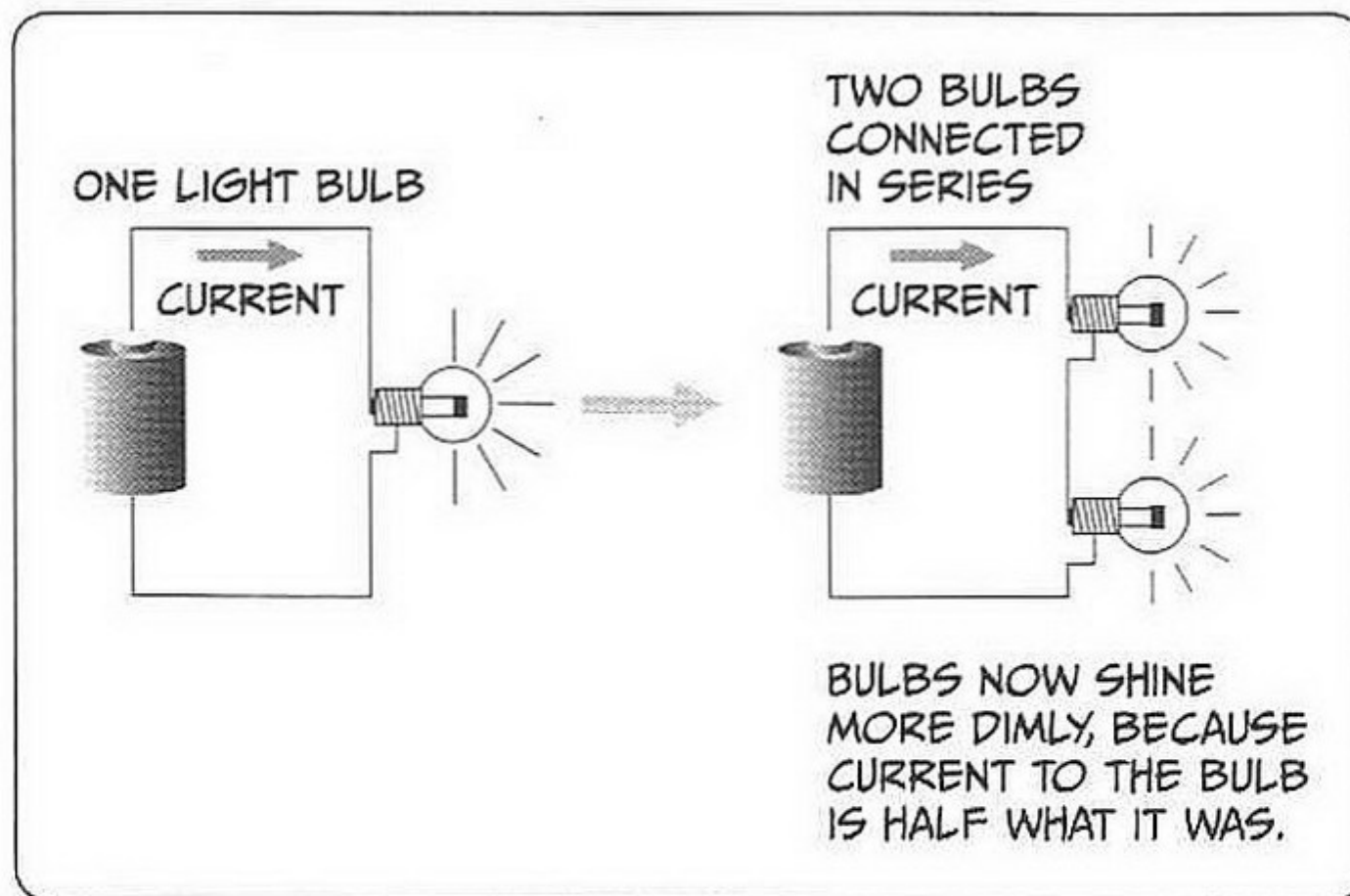

Series connection of light bulbs

The other basic method of connecting resistances is called a *parallel connection*. At this time, the value of the effective resistance can be obtained by calculating the reciprocal of the sum of the reciprocals of each resistance.

$$\text{Effective resistance} = R_0 = \frac{1}{\frac{1}{R_1} + \frac{1}{R_2} + \dots + \frac{1}{R_n}}$$

The total resistance when two resistances are connected in parallel can be obtained as follows.

$$\text{Effective resistance} = R_0 = \frac{R_1 \times R_2}{R_1 + R_2} \quad (\text{Product over sum})$$

In a parallel circuit, the voltage applied to each resistance is the same, because the current branches and flows to each resistance.

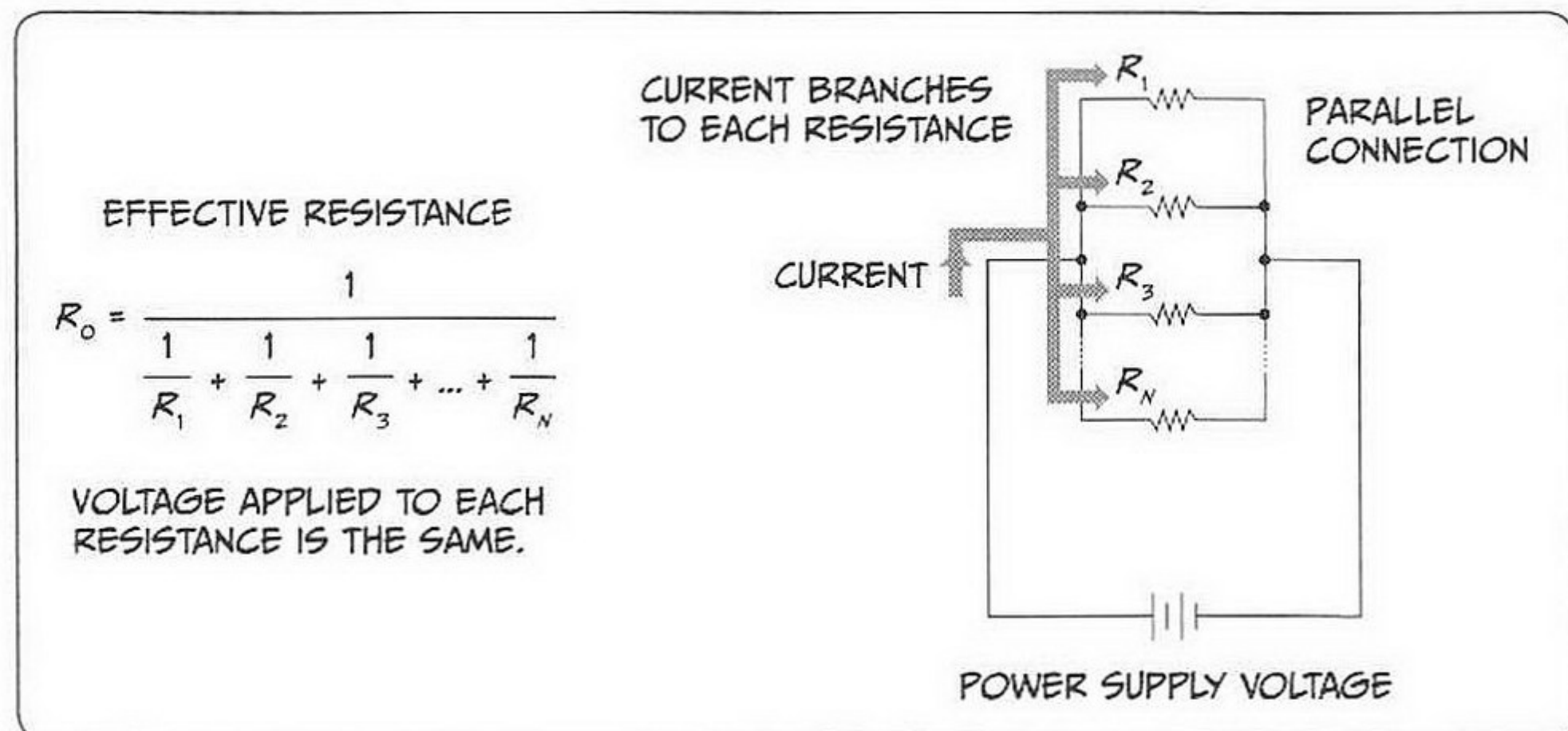

Parallel connection and effective resistance

If two light bulbs of the same size are connected in parallel to a power supply, the brightness of each bulb is the same as it is when there is only one bulb. Since the current flowing to each bulb is the same as the current flowing when only one bulb is connected, the total current is doubled.

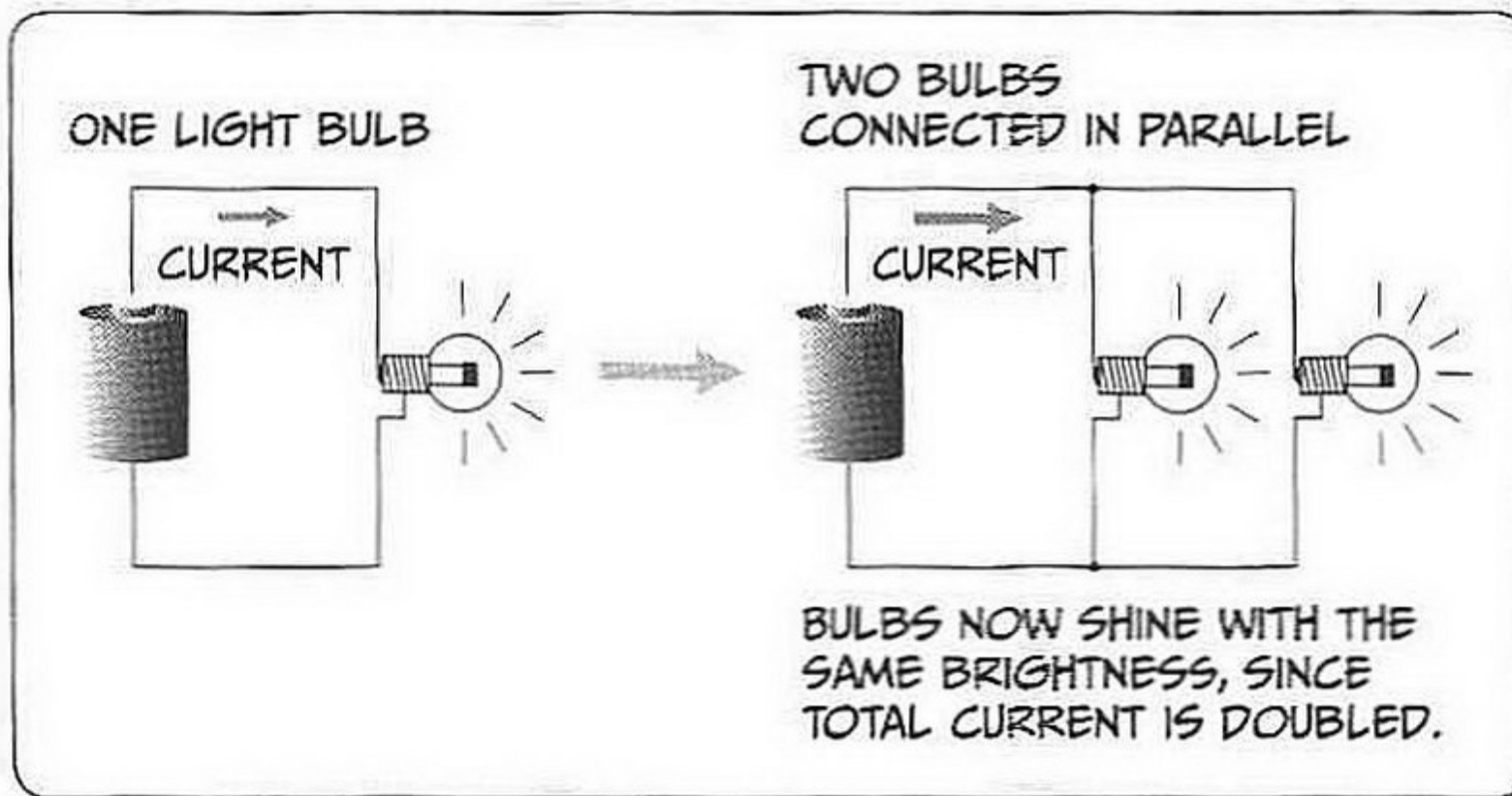

Series connection of light bulbs

The 120V electric appliances that we use in our homes are connected in parallel to a 120V power supply. If we increase the number of electric appliances connected to the power supply, the total current flowing also increases.



3

HOW DOES ELECTRICITY WORK?



WHY DOES ELECTRICITY
PRODUCE HEAT?

SO, HOW'S
IT GOING?

ARE THE
LESSONS
GOING WELL?



THEY'RE
GREAT!



HIKARU SENSEI
AND I HAVE REALLY
HIT IT OFF!

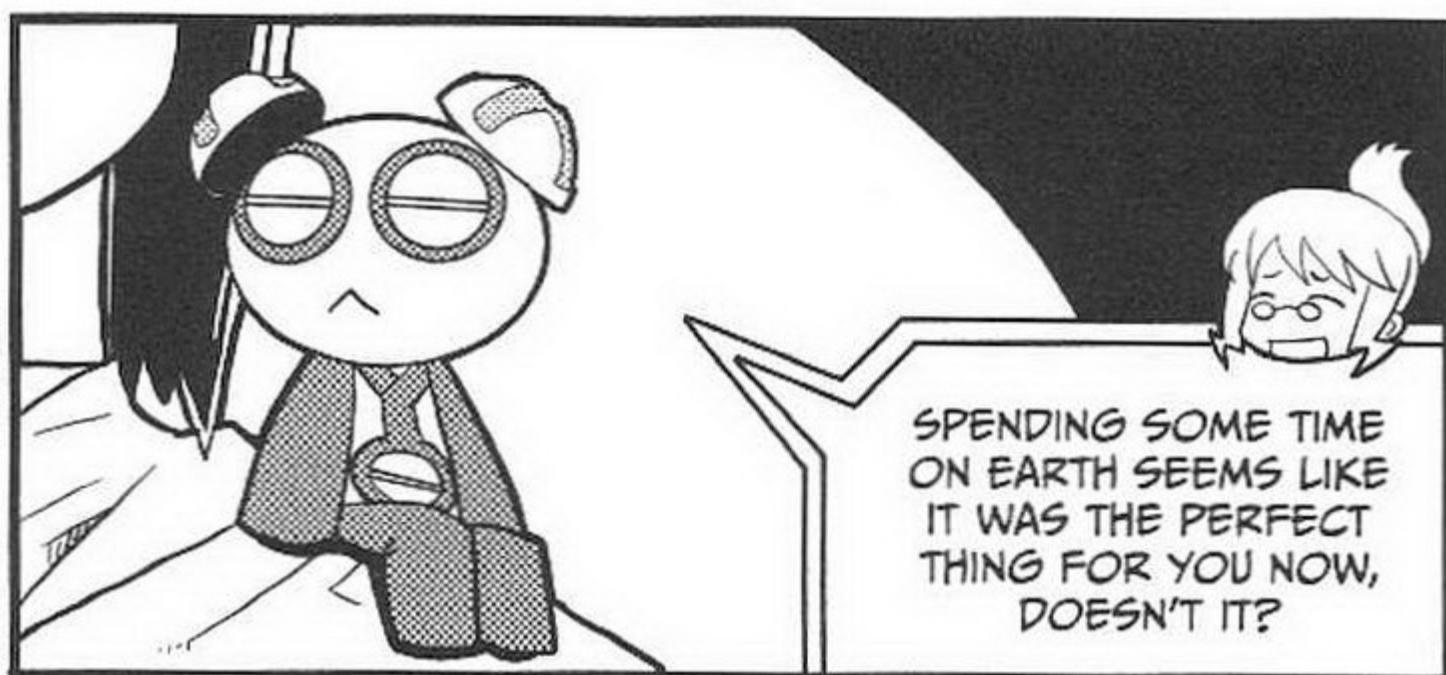

SPENDING SOME TIME
ON EARTH SEEMS LIKE
IT WAS THE PERFECT
THING FOR YOU NOW,
DOESN'T IT?

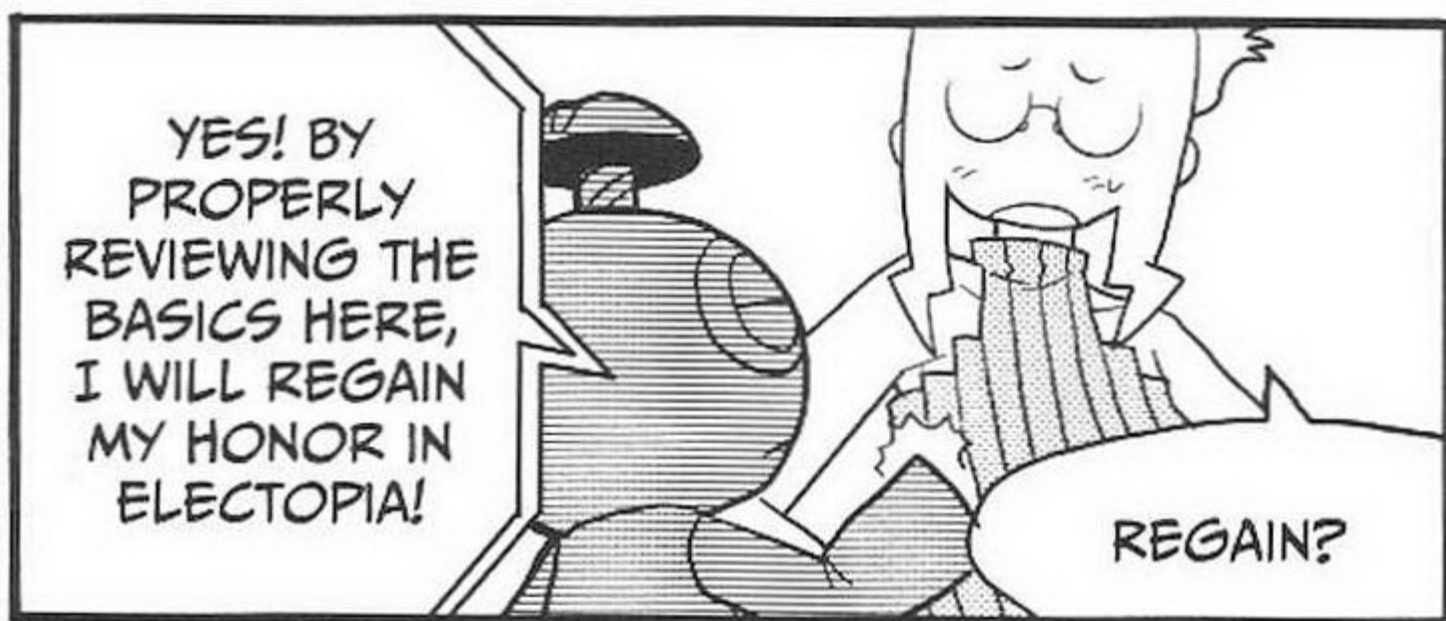

YES! BY
PROPERLY
REVIEWING THE
BASICS HERE,
I WILL REGAIN
MY HONOR IN
ELECTOPIA!

REGAIN?



YOU NEVER
HAD ANY
HONOR IN
THE FIRST
PLACE!

JEEZ! THAT
WAS ROUGH.

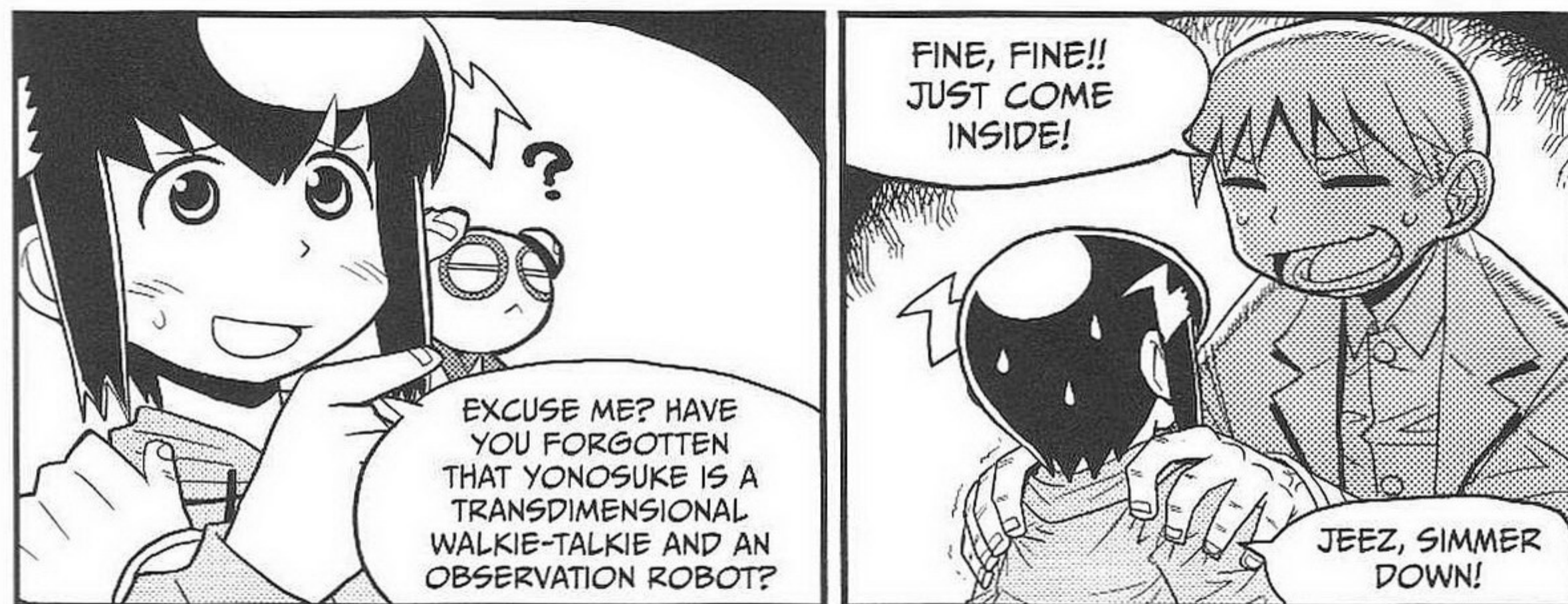



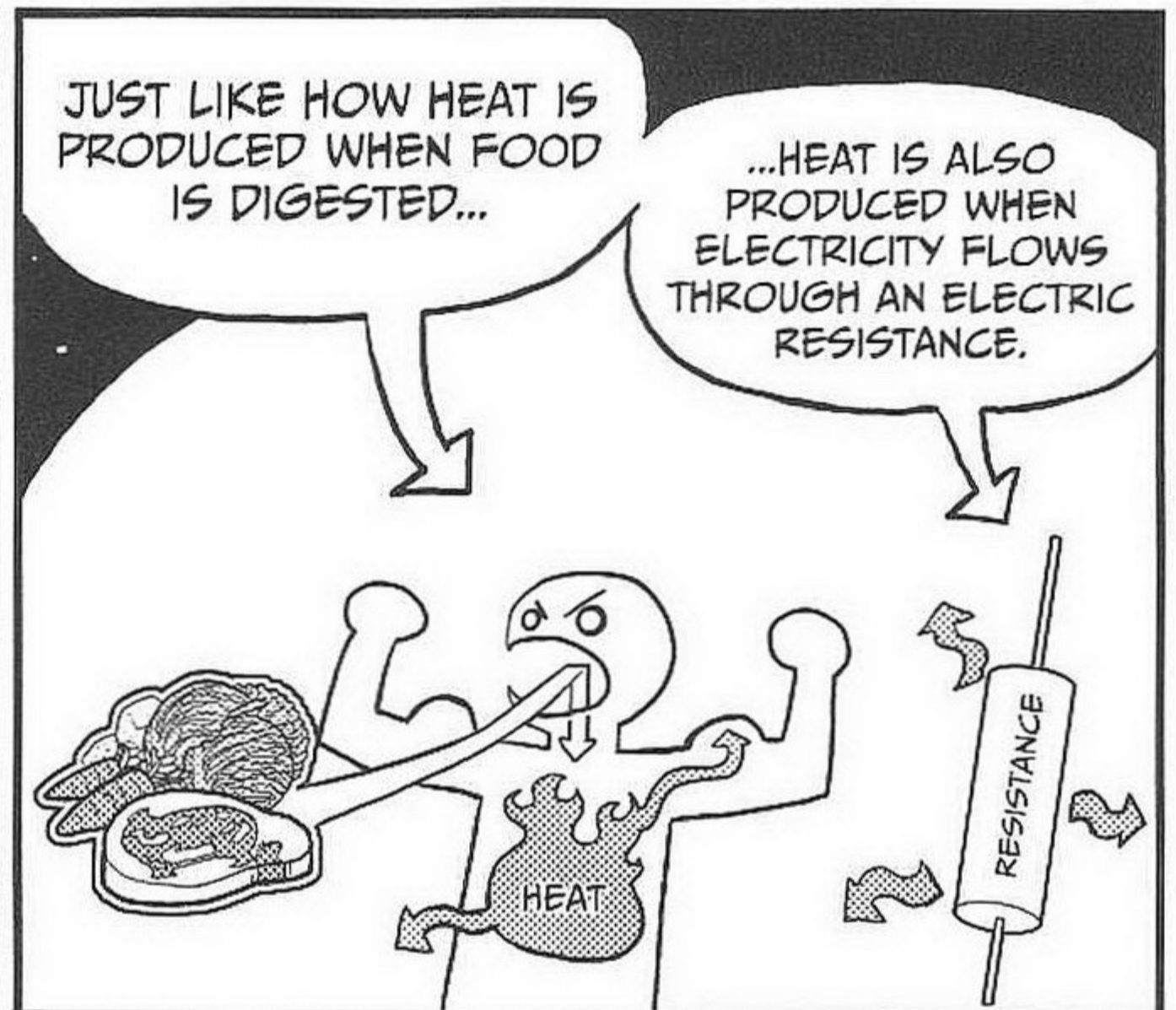
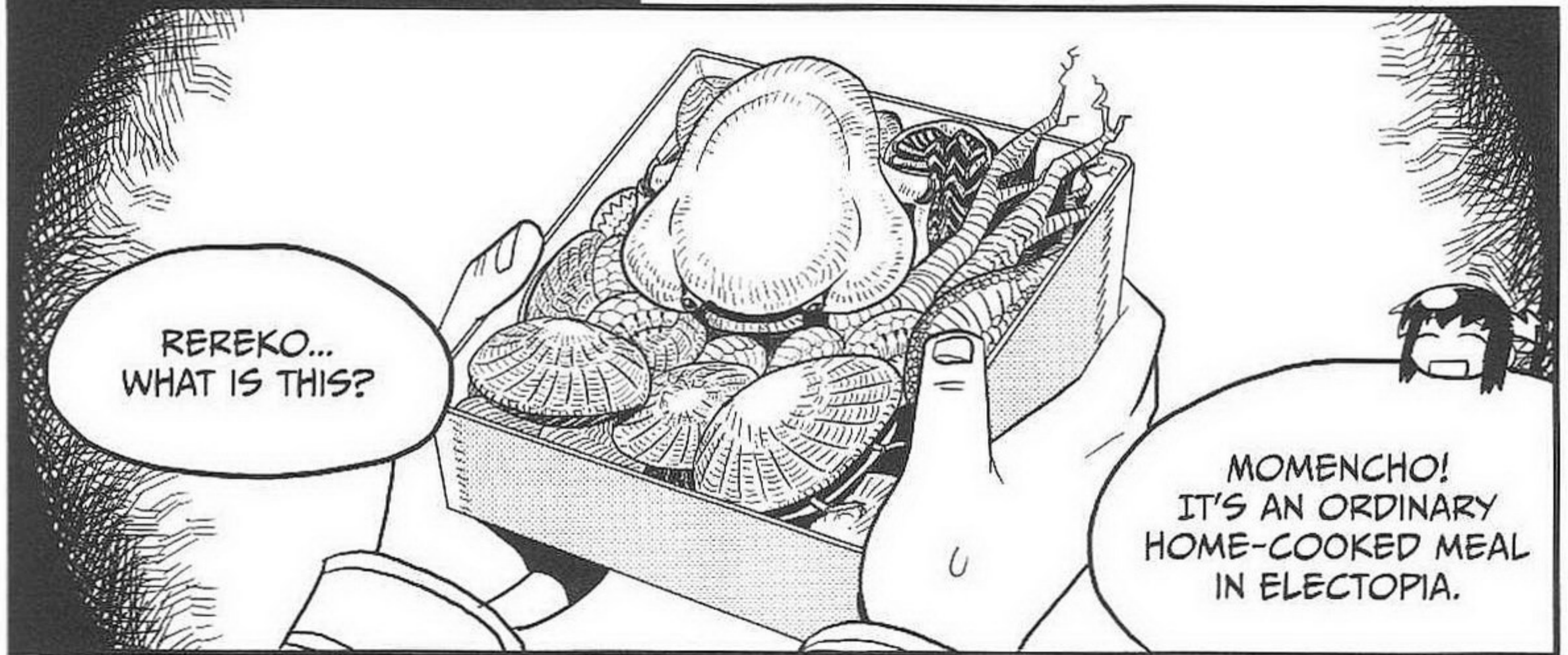



FOR EXAMPLE, YOU CAN FIND THE AMOUNT OF HEAT PRODUCED WHEN CURRENT I FLOWS THROUGH RESISTANCE R FOR T SECONDS BY CALCULATING $I^2 \times R \times T$. THE SYMBOL Q IS USED TO REPRESENT HEAT, AND WE MEASURE IT IN J (JOULES).

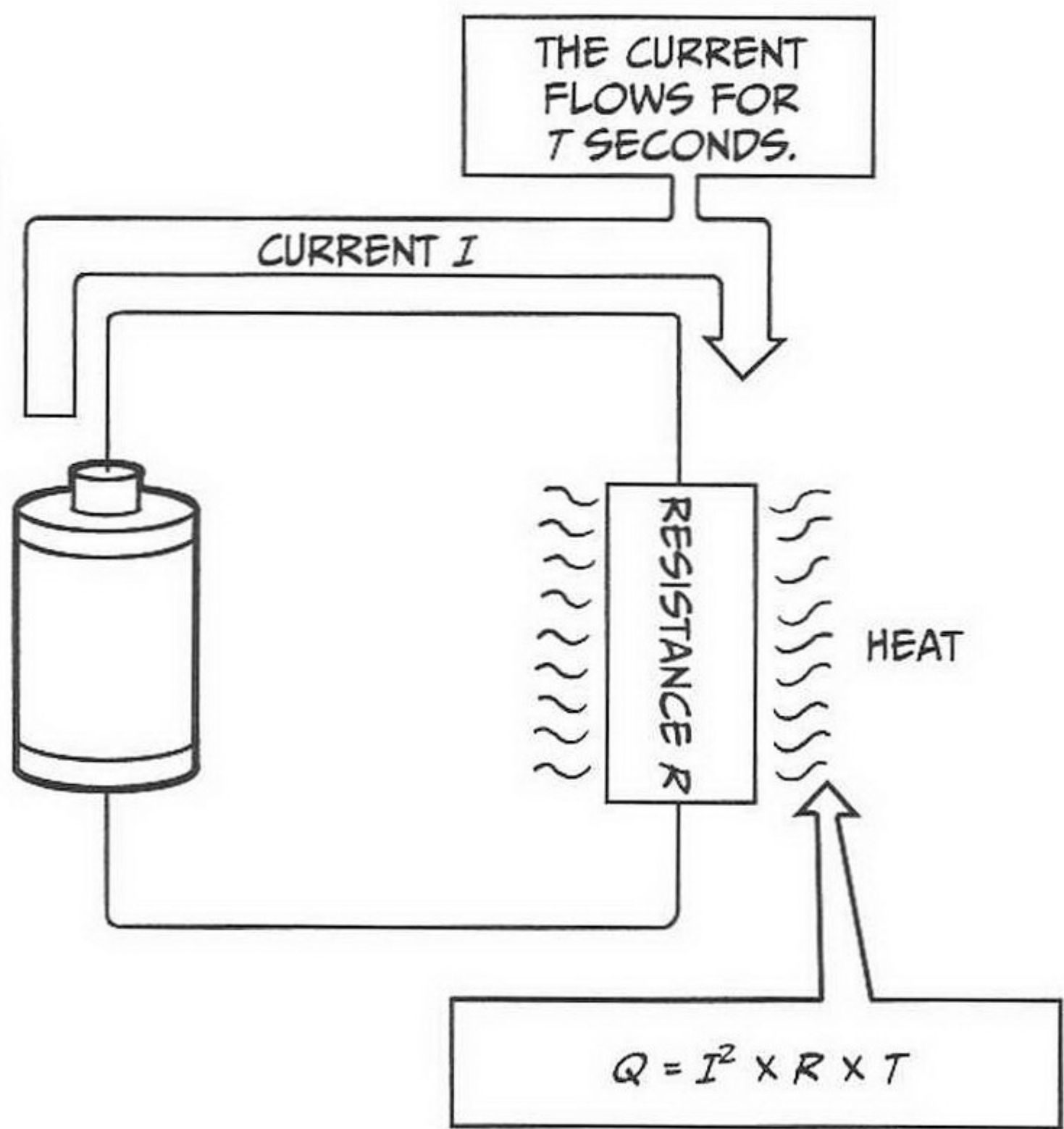

THE AMOUNT OF HEAT REQUIRED TO RAISE 1 GRAM OF PURE WATER FROM 14.5°C TO 15.5°C AT 1 ATMOSPHERIC PRESSURE IS APPROXIMATELY 4.2J, AND THIS CORRESPONDS TO 1 CALORIE.



HOW IS HEAT GENERATED BY CURRENT?

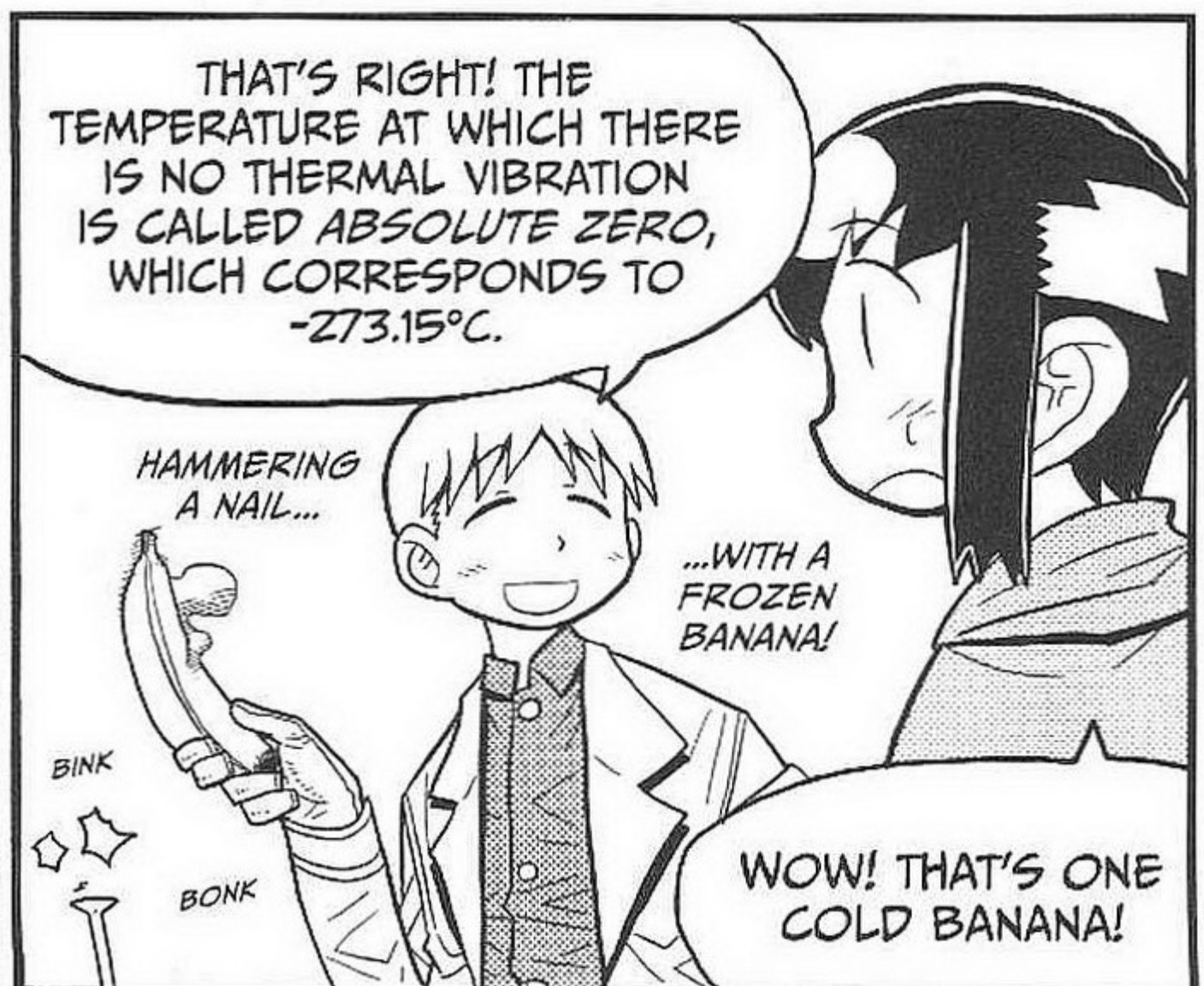
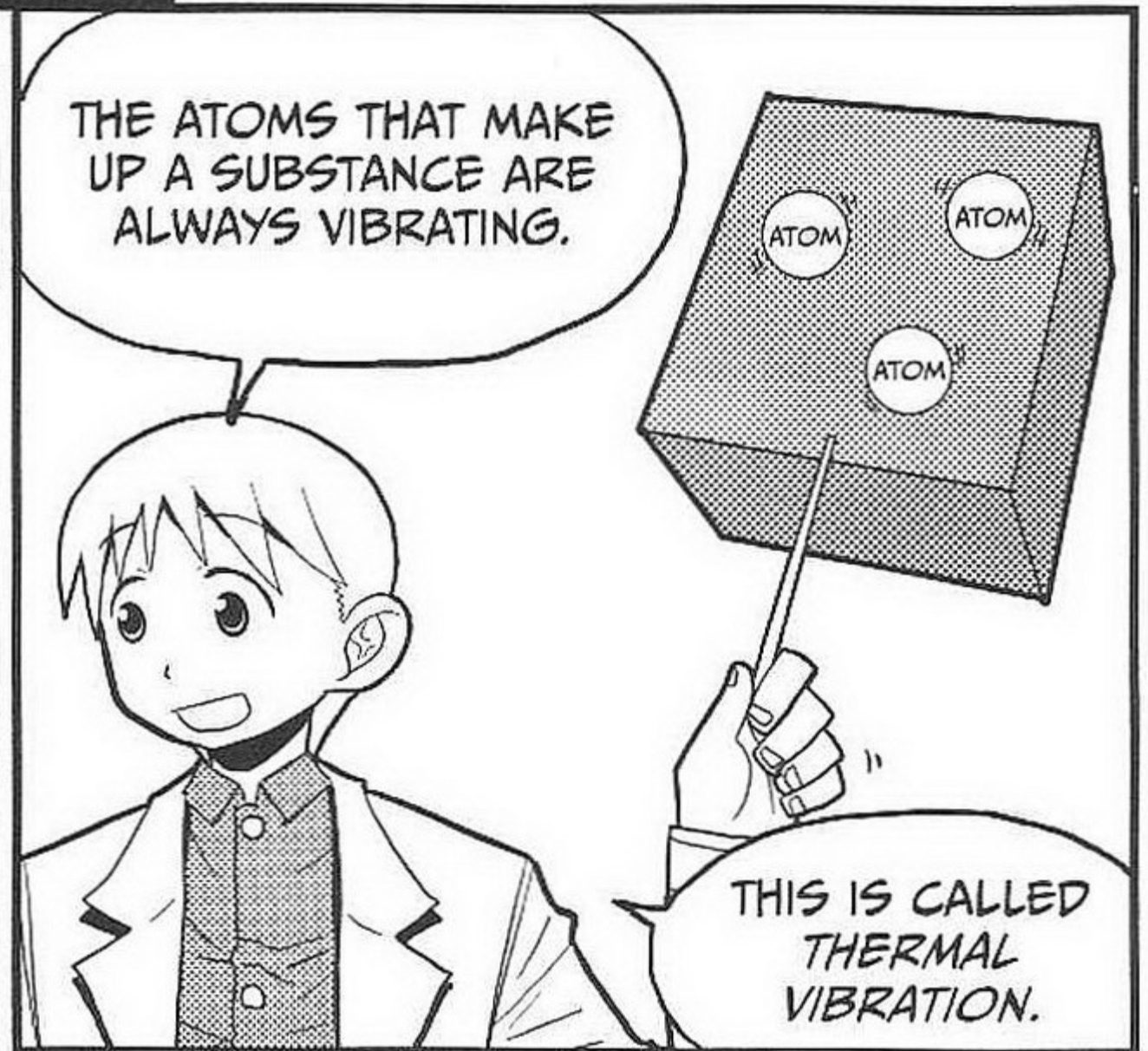

WE RECENTLY TALKED ABOUT THE LOAD HAVING A PROPERTY CALLED ELECTRIC RESISTANCE, WHICH HINDERS THE FLOW OF CURRENT.*



RIGHT...

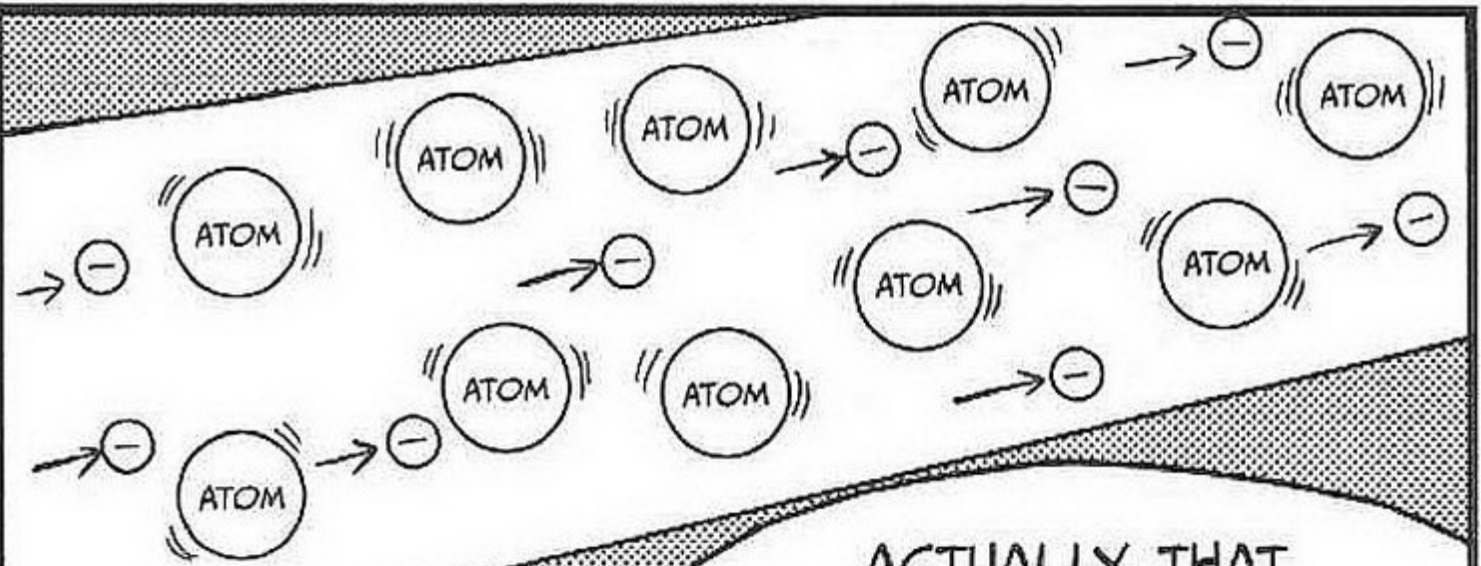

ACTUALLY, THAT PROPERTY IS DUE TO THE VIBRATION OF THE ATOMS.



OF COURSE! IF AN ATOM IS VIBRATING, IT'S HARDER FOR ELECTRONS TO MOVE AROUND!

* SEE PAGE 61.

ELECTRIC WIRE HAS ELECTRIC RESISTANCE AT NORMAL TEMPERATURES—EVEN IF IT'S JUST A SMALL AMOUNT.

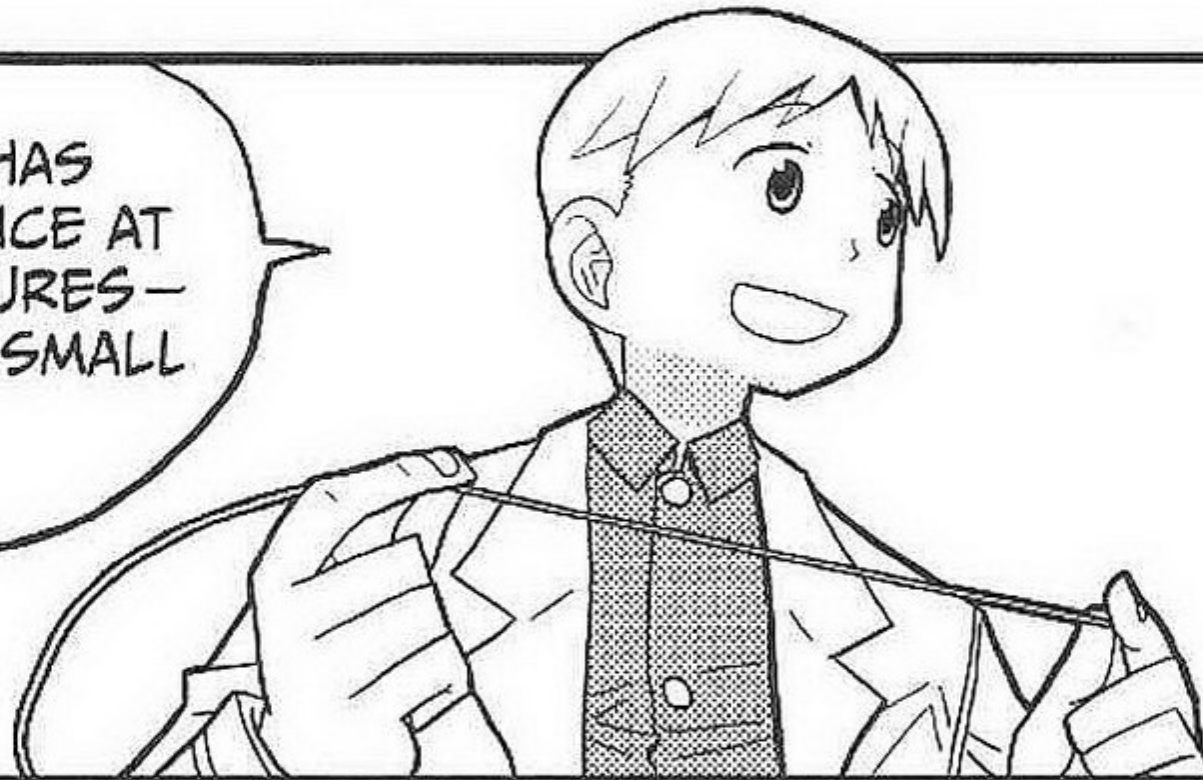

OKAY, I GET THAT...

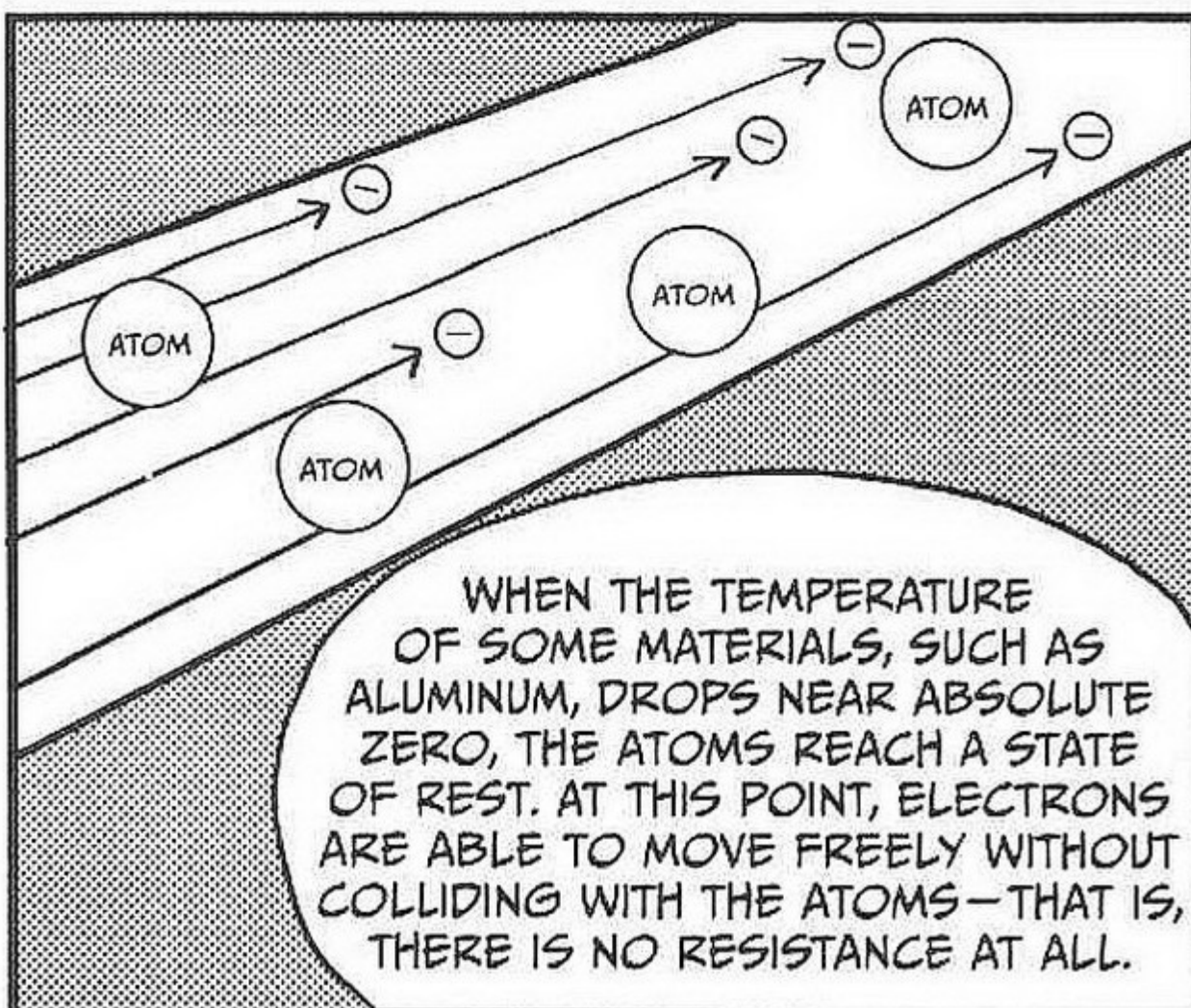

WHEN THE TEMPERATURE OF SOME MATERIALS, SUCH AS ALUMINUM, DROPS NEAR ABSOLUTE ZERO, THE ATOMS REACH A STATE OF REST. AT THIS POINT, ELECTRONS ARE ABLE TO MOVE FREELY WITHOUT COLLIDING WITH THE ATOMS—THAT IS, THERE IS NO RESISTANCE AT ALL.

THIS PHENOMENON IS CALLED SUPERCONDUCTIVITY.

超伝導



SWEET! THAT SOUNDS SO COOL!

WHEN CURRENT FLOWS IN ALUMINUM WIRE AT A NORMAL TEMPERATURE, ELECTRONS VIOLENTLY COLLIDE WITH ALUMINUM ATOMS, CREATING LARGER THERMAL VIBRATIONS AND GENERATING HEAT.

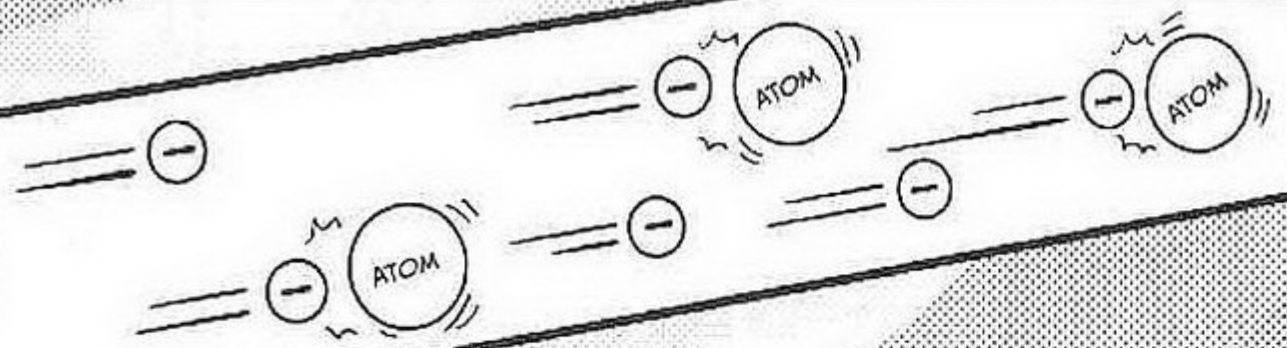

SO AT NORMAL TEMPERATURE, THE THERMAL VIBRATION INCREASES.

YEP! AND AS THE VIBRATION OF THE ATOMS INCREASES, THE ELECTRONS CAN NO LONGER MOVE SMOOTHLY, SO THE ELECTRIC RESISTANCE ALSO INCREASES.

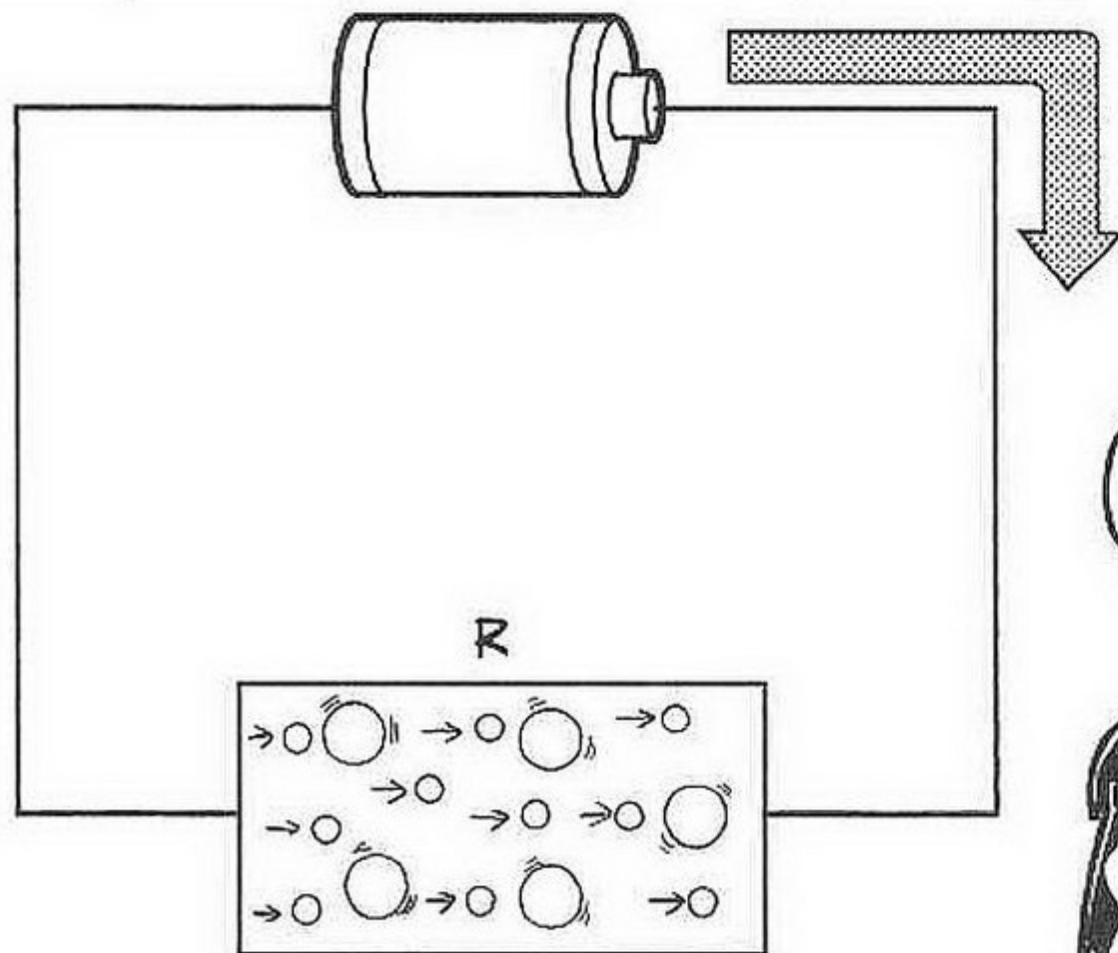

OF COURSE...

IF ELECTRONS COLLIDE WITH ATOMS CAUSING THE VIBRATION TO INCREASE, ELECTRIC RESISTANCE WILL ALSO INCREASE.

GENERALLY, AS THE TEMPERATURE OF A METAL INCREASES, RESISTANCE ALSO INCREASES.

HIGH TEMPERATURE = HIGH RESISTANCE

LOW TEMPERATURE = LOW RESISTANCE

WHEN THE HUMIDITY DROPS, THE RESISTANCE ALSO DECREASES.

FOR EXAMPLE, THINK ABOUT WALKING AROUND INSIDE A TRAIN...

A TRAIN?

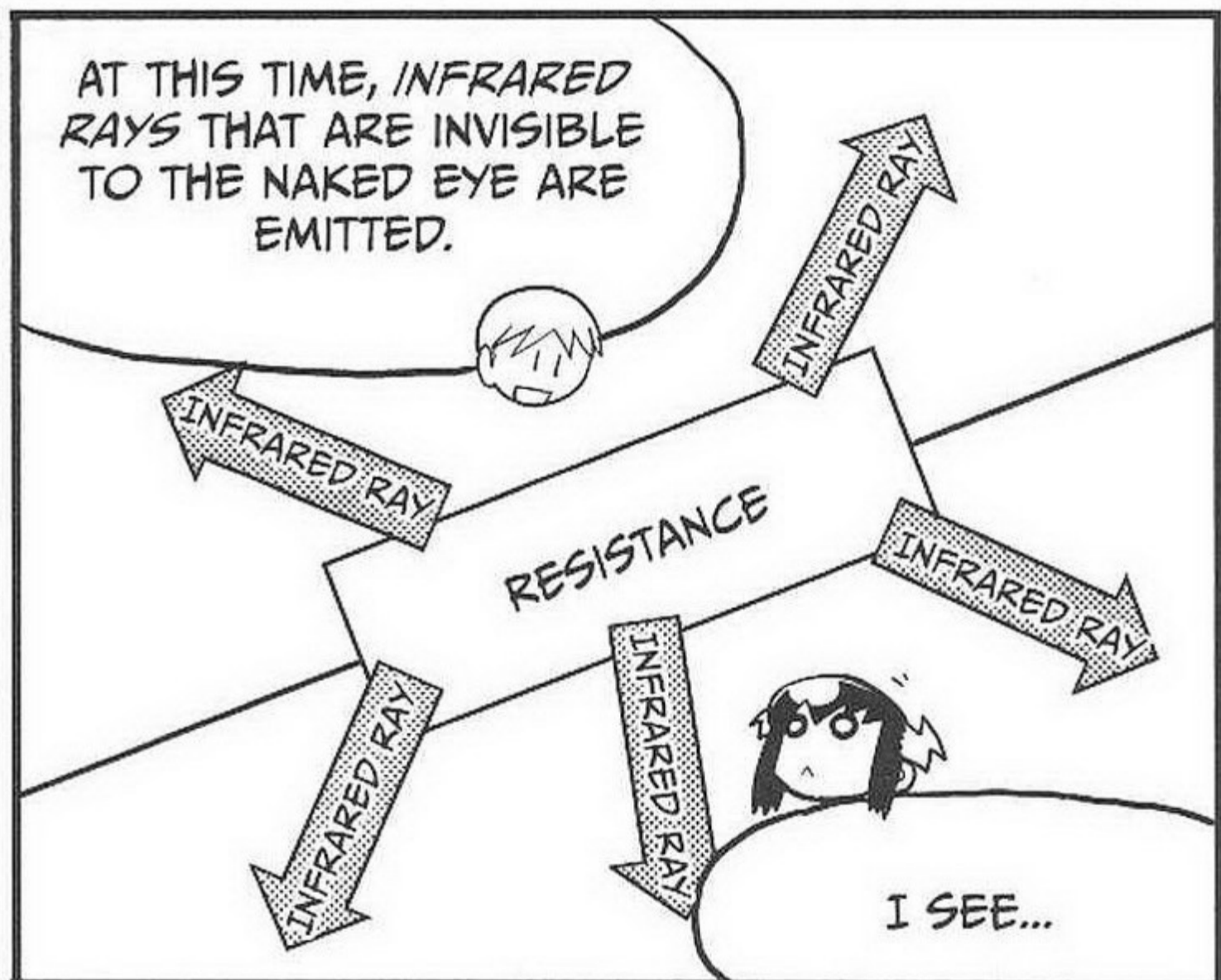
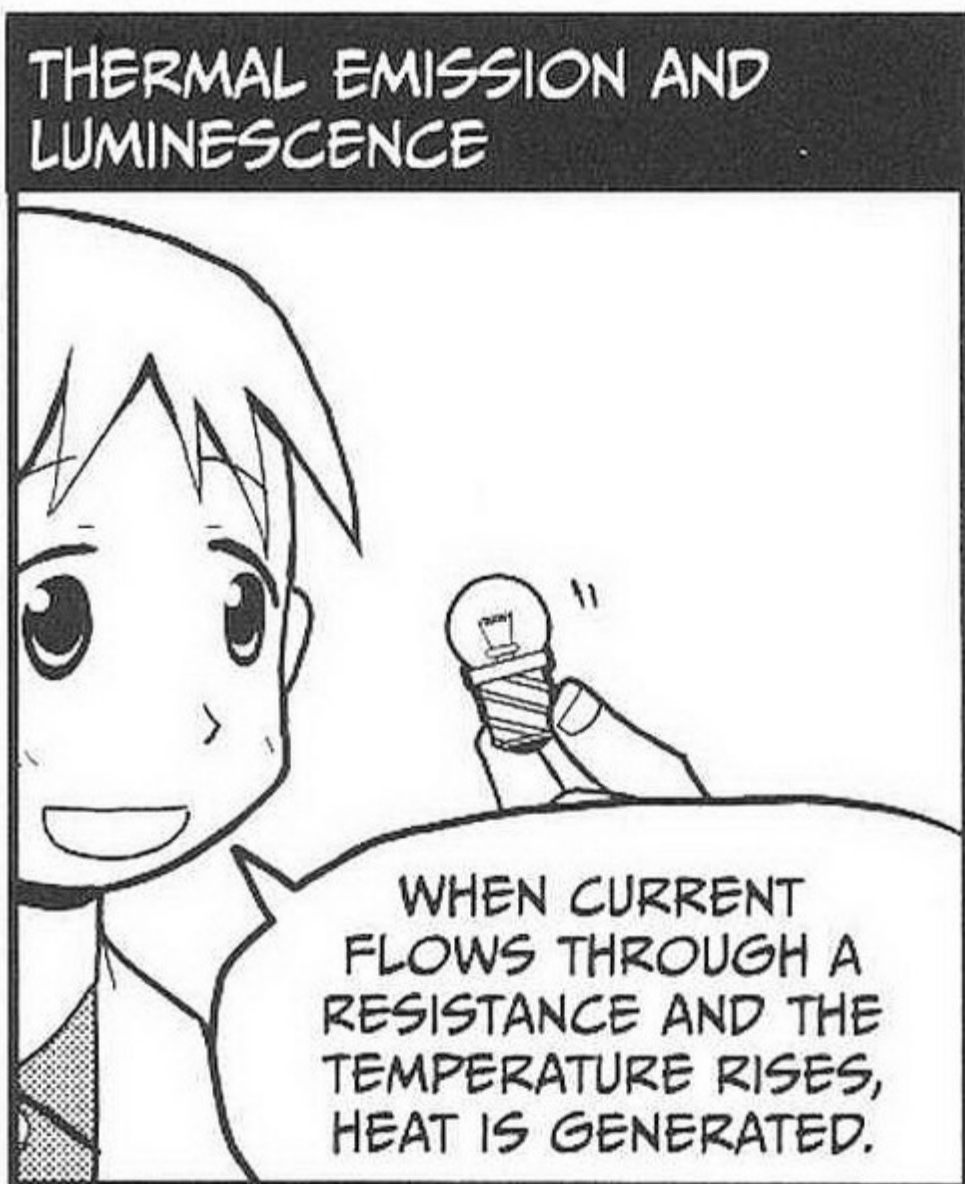
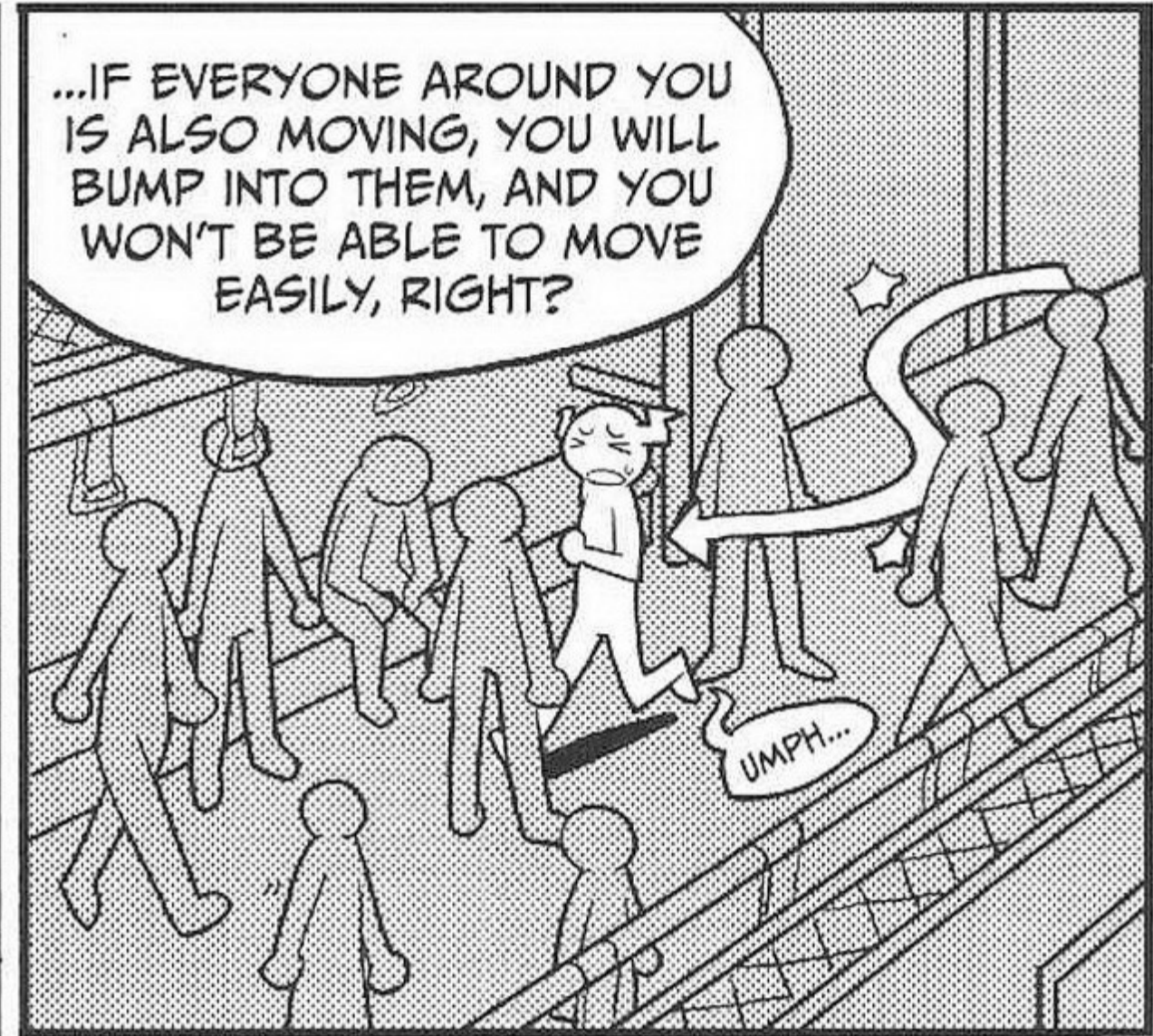
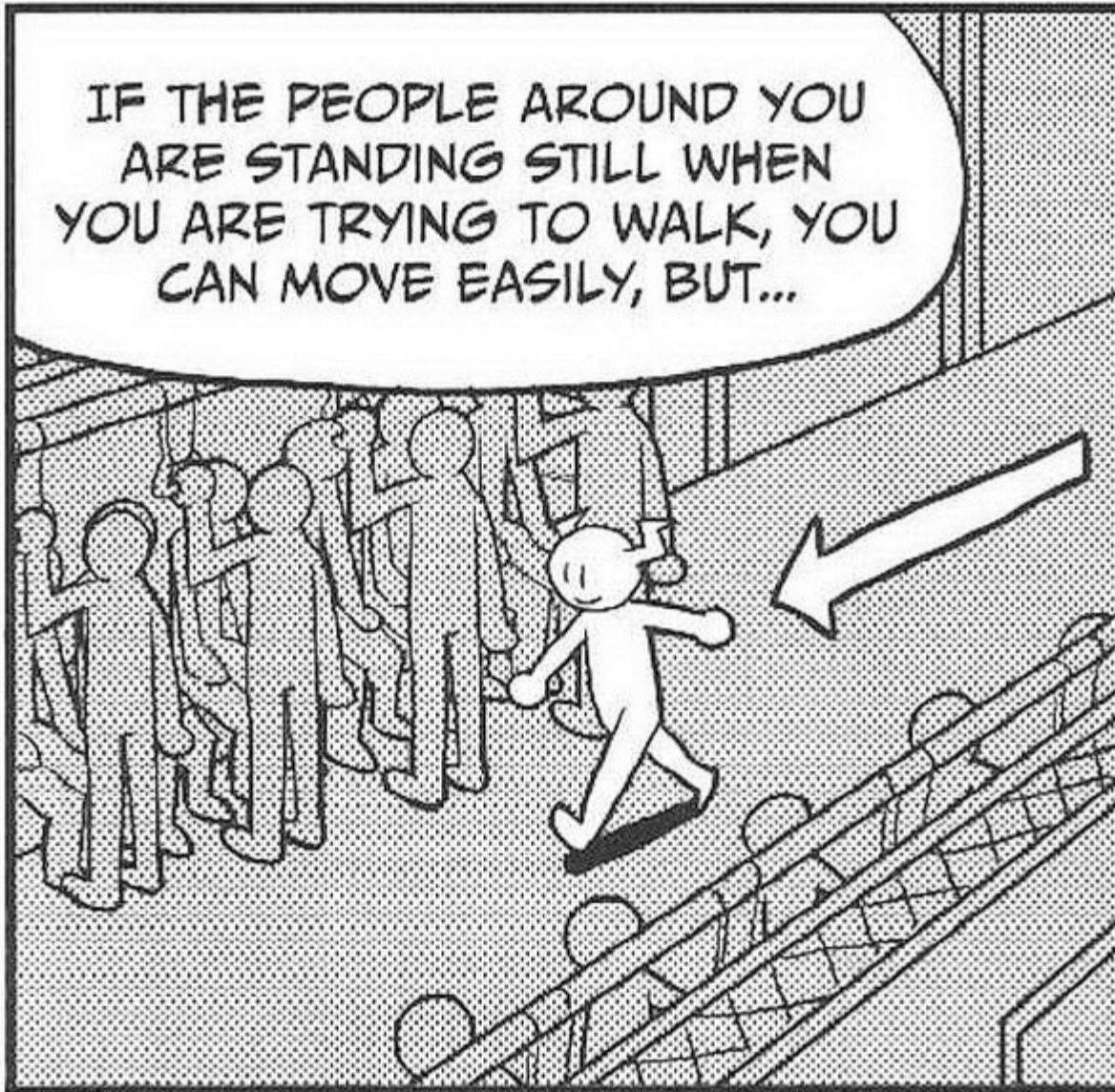

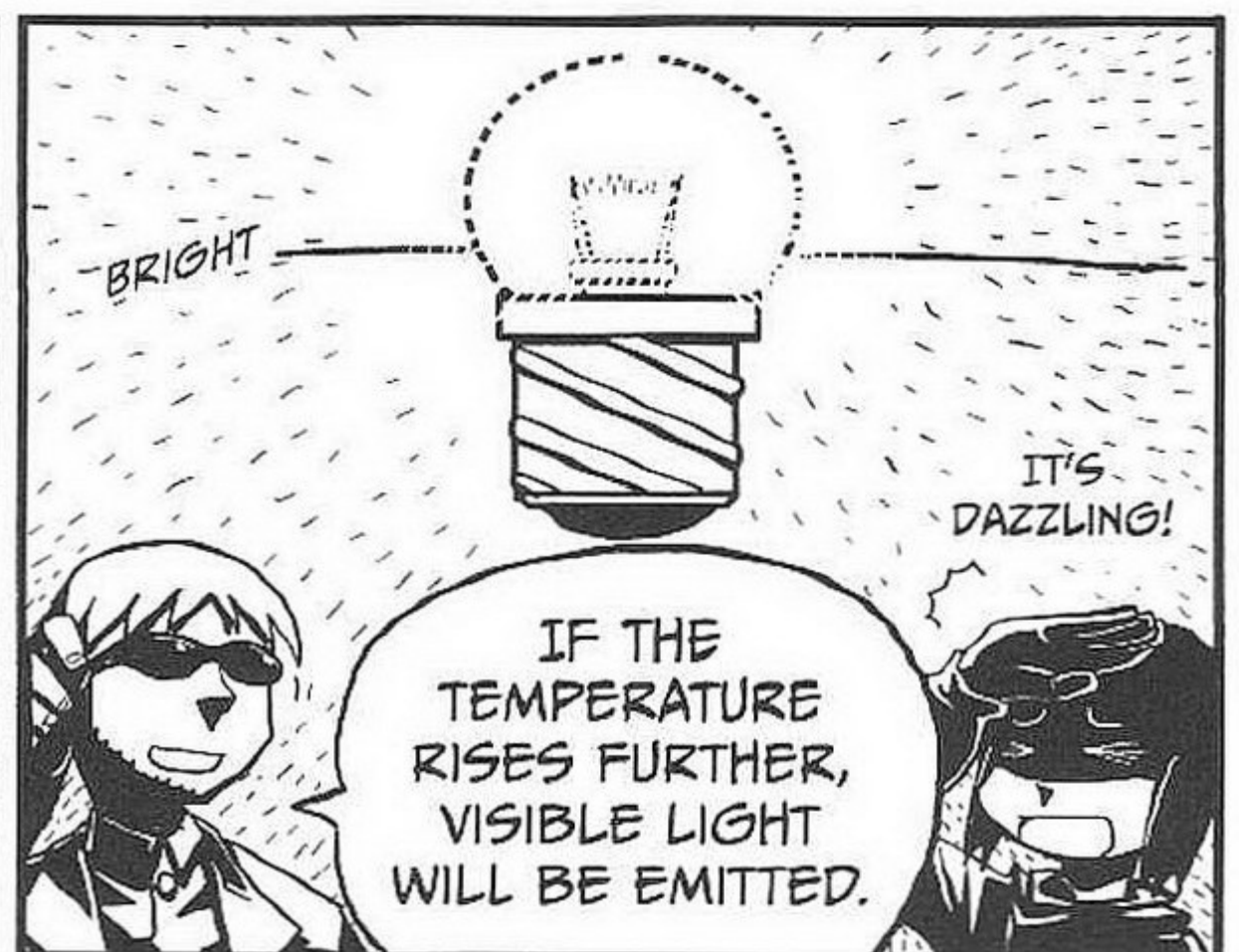
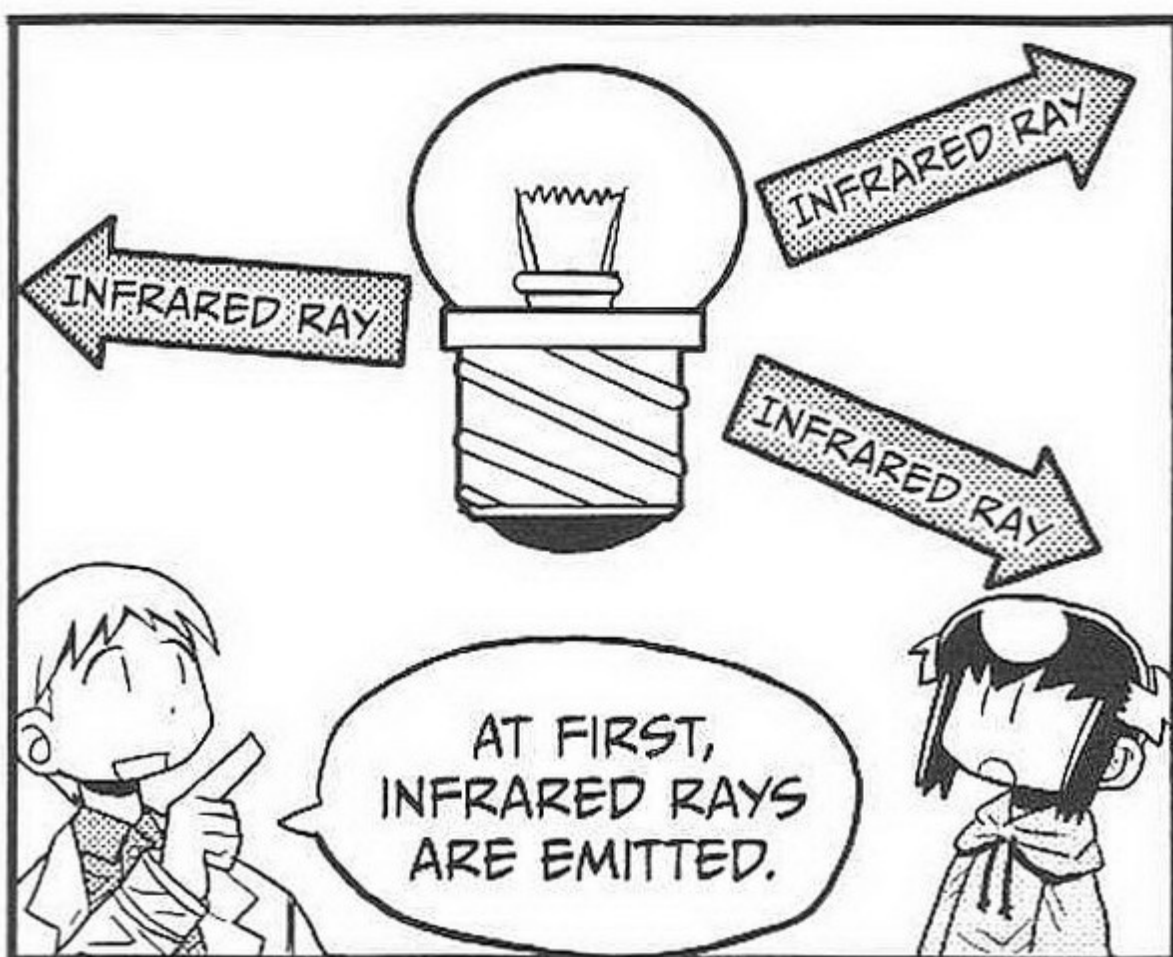
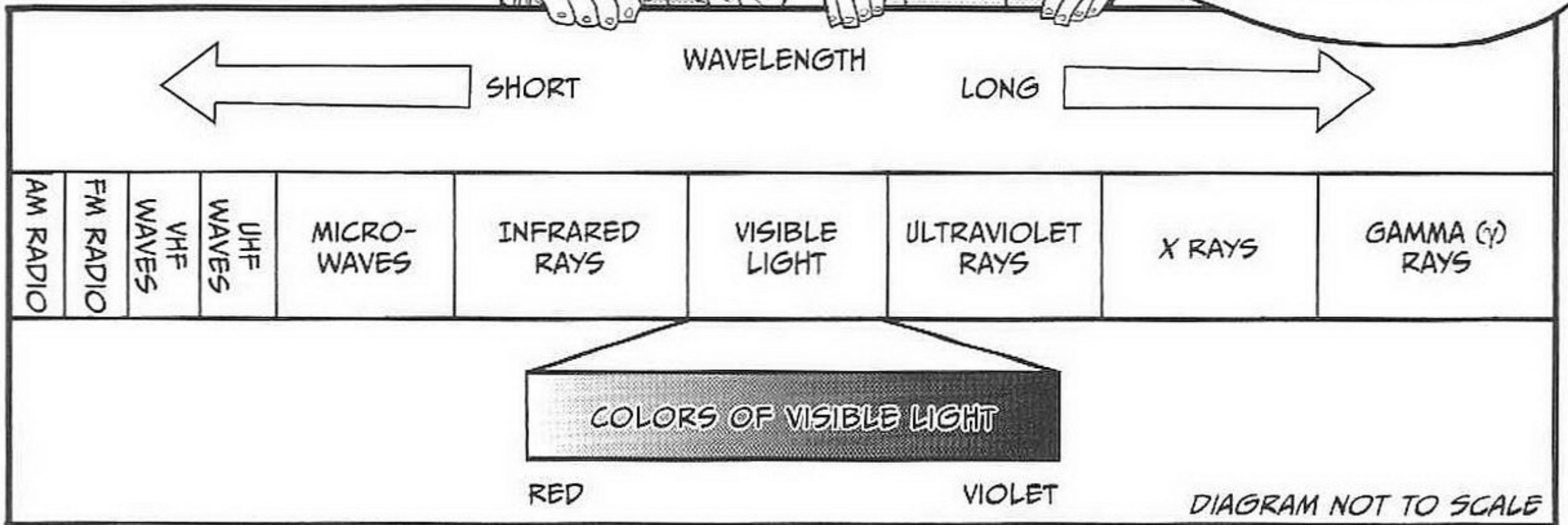
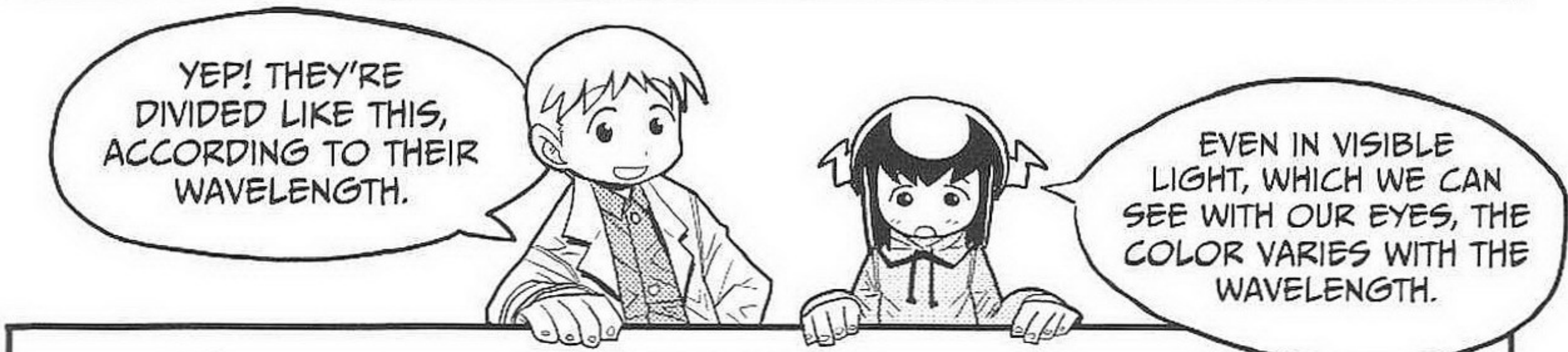
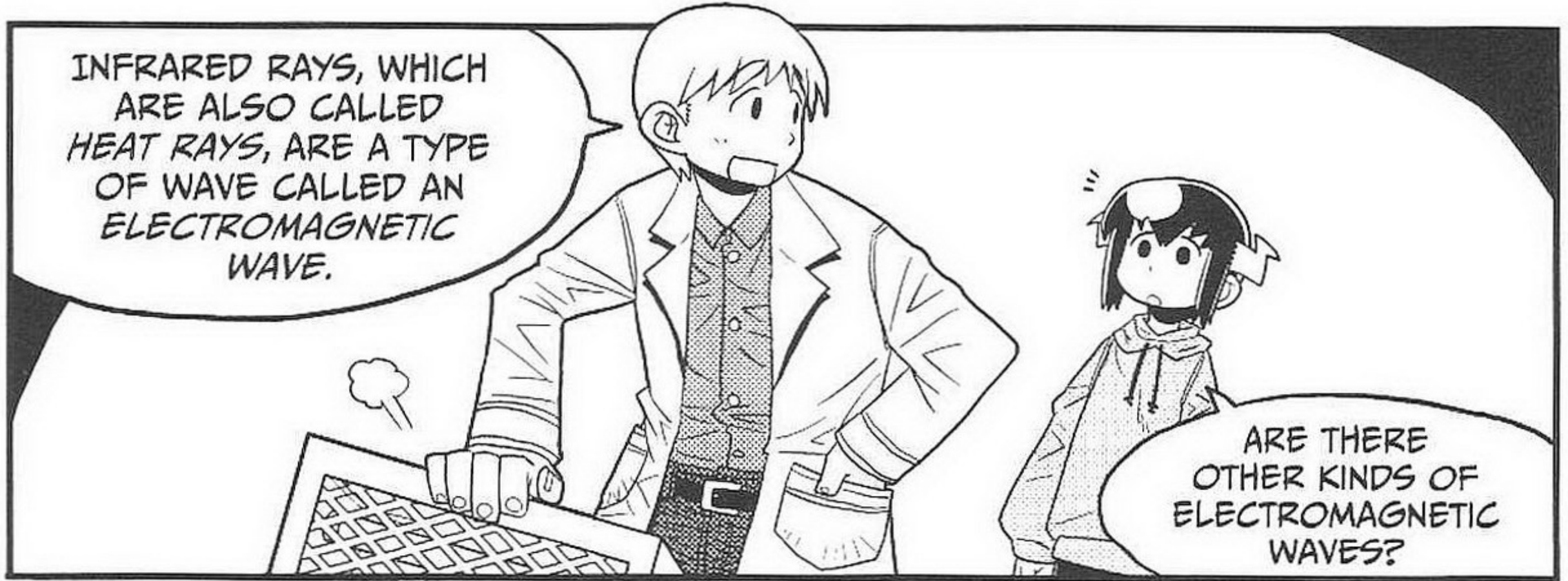

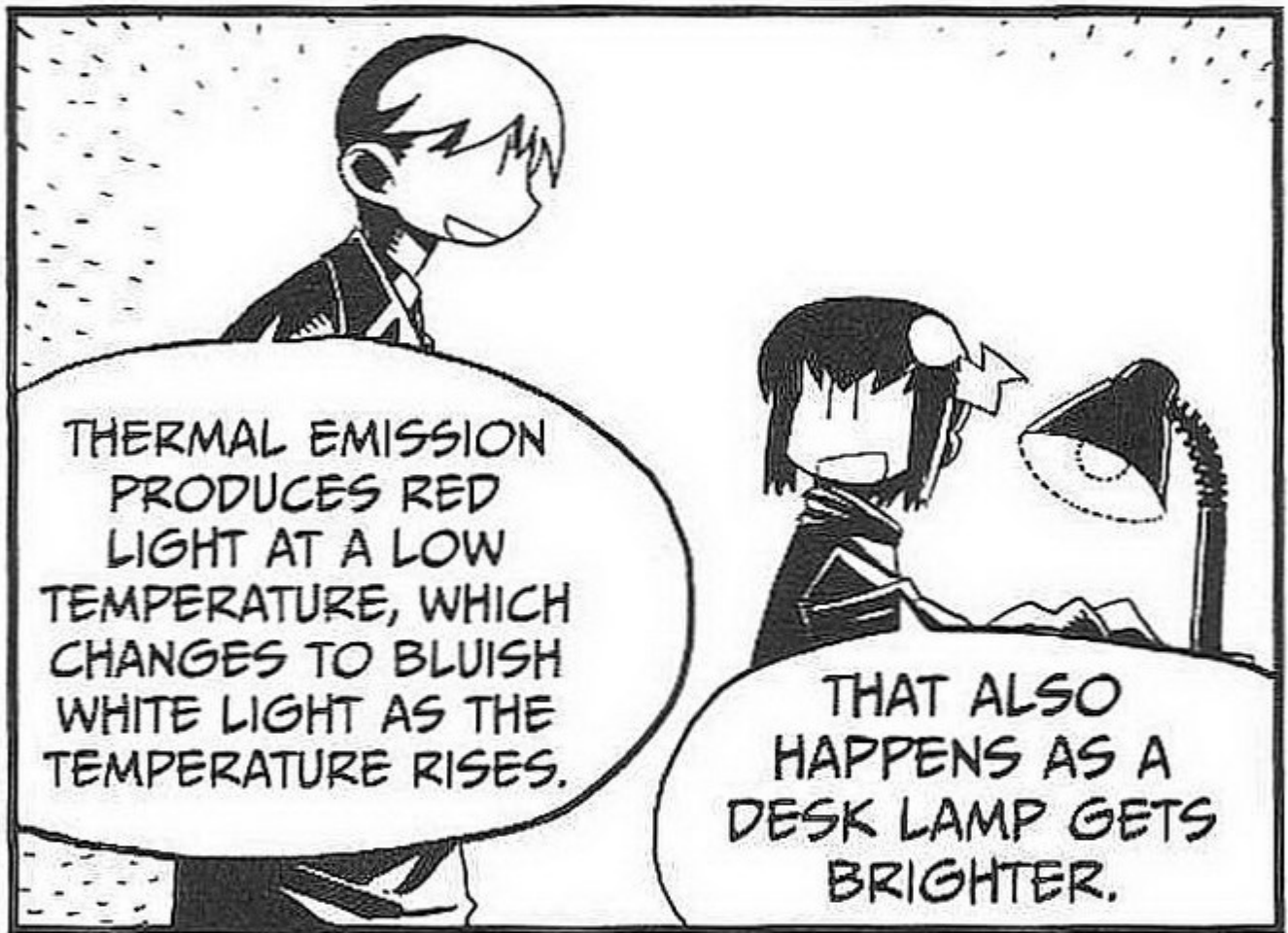
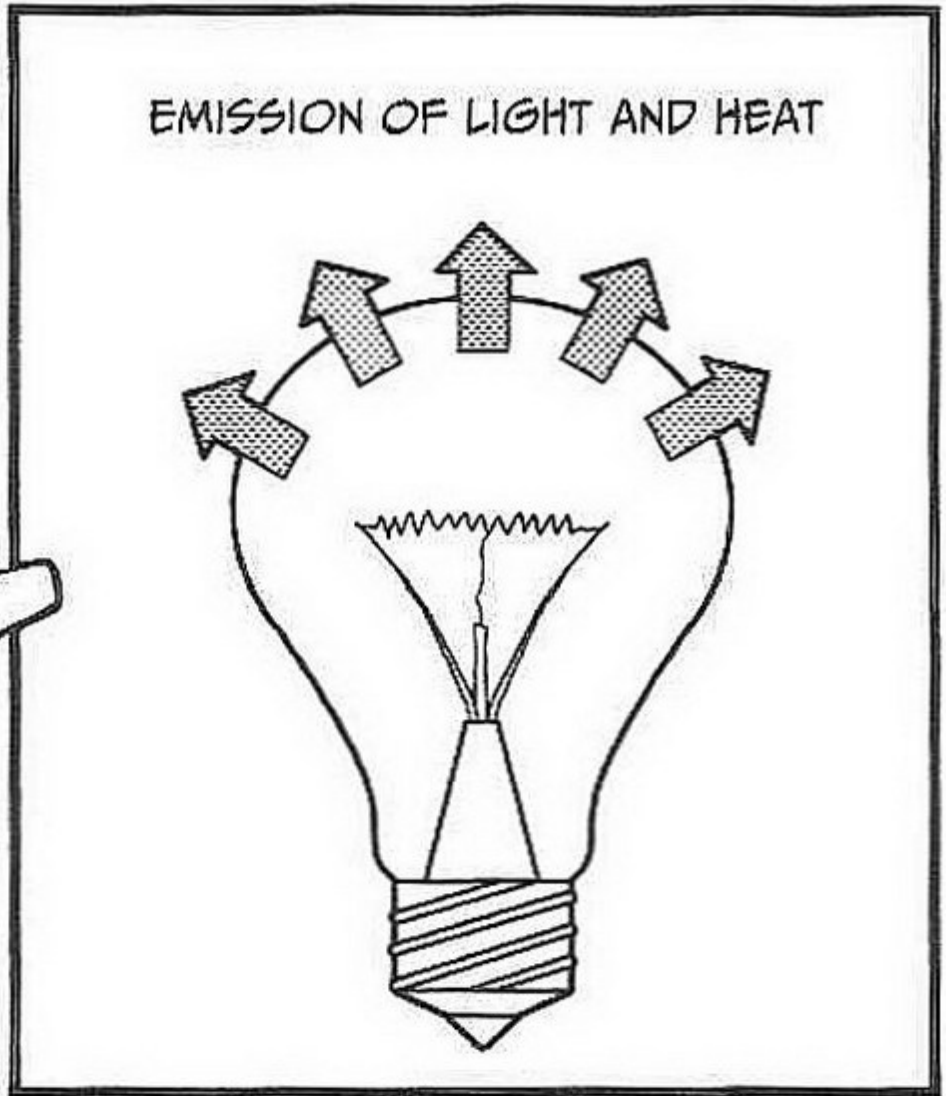
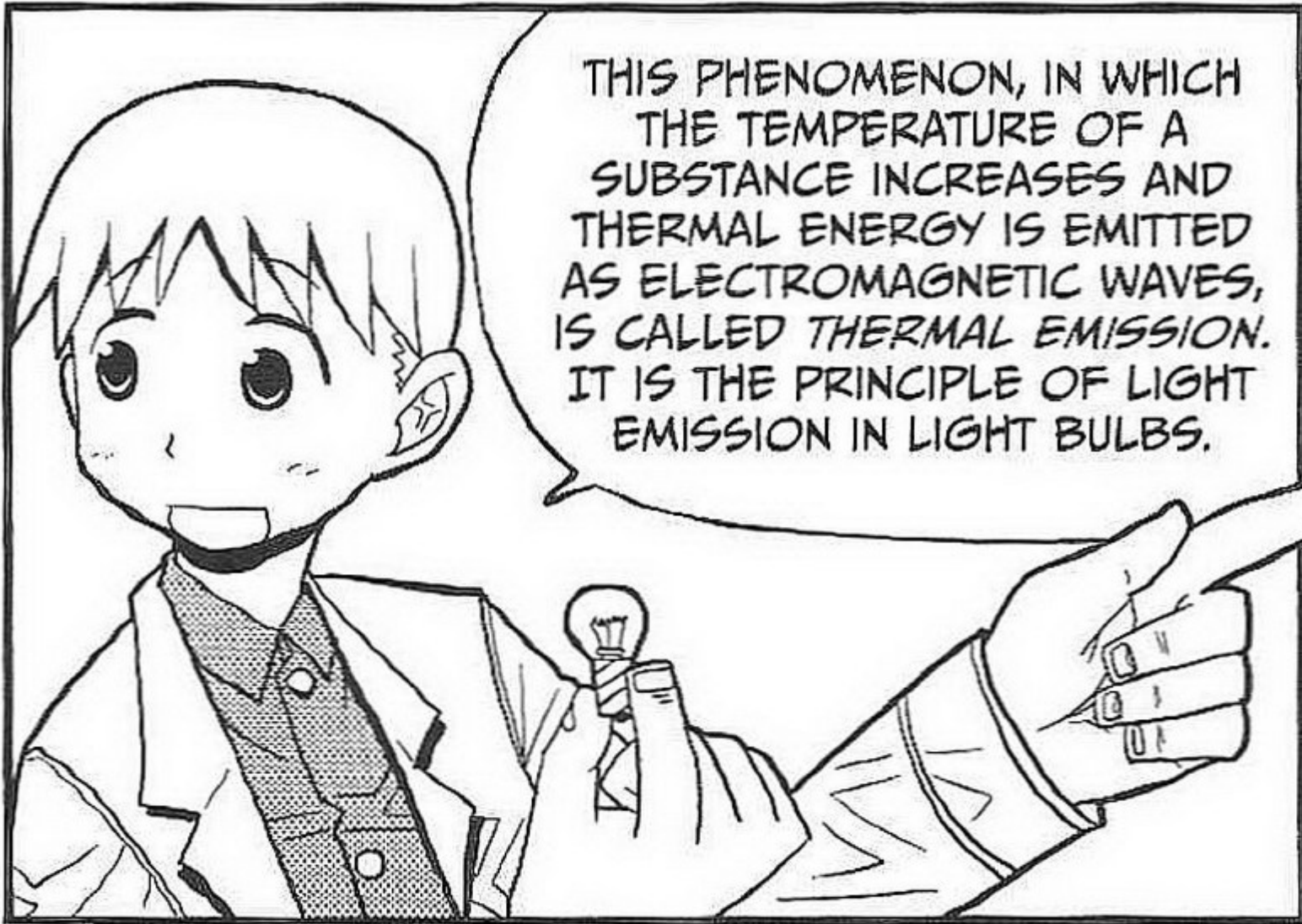

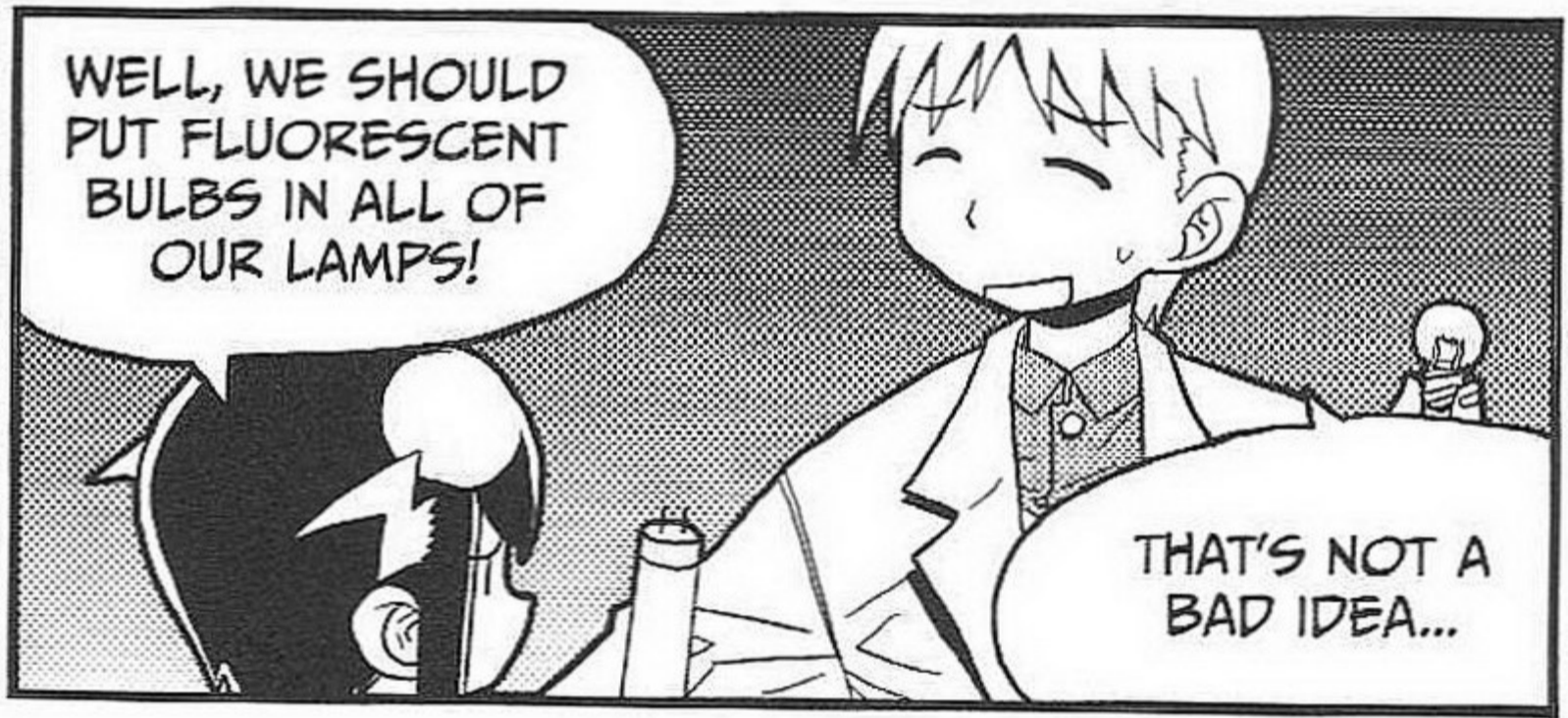
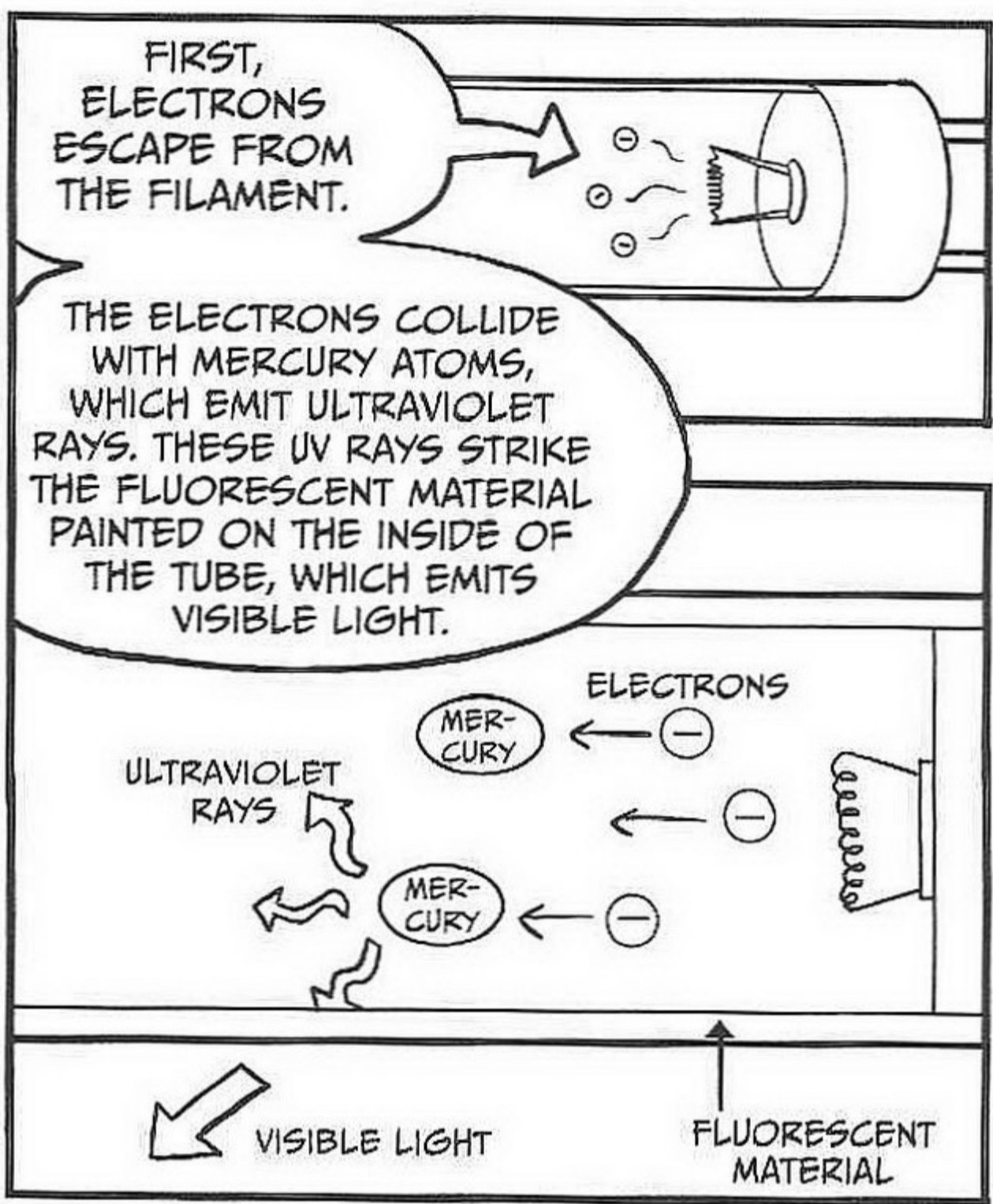

CURRENT AND
MAGNETIC FIELDS

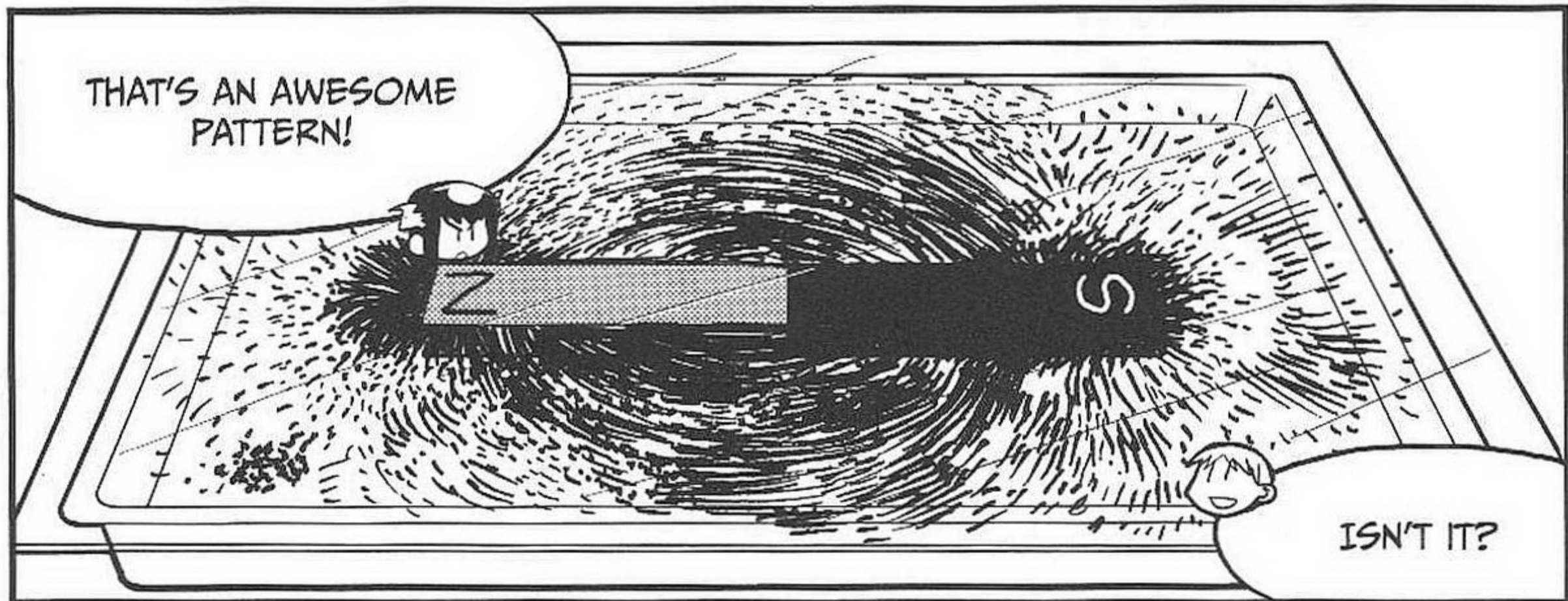

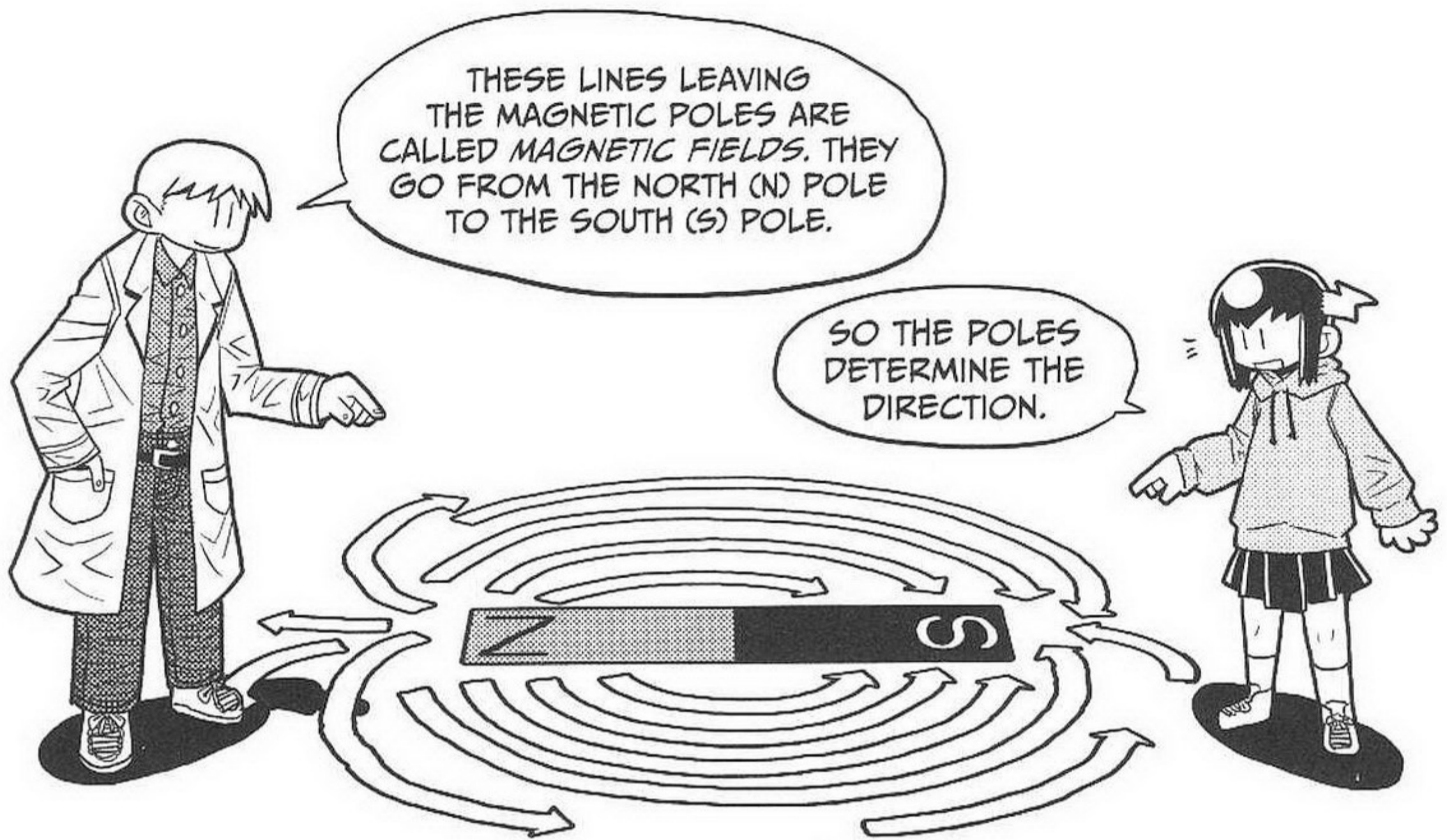

THESE LINES LEAVING THE MAGNETIC POLES ARE CALLED MAGNETIC FIELDS. THEY GO FROM THE NORTH (N) POLE TO THE SOUTH (S) POLE.

SO THE POLES DETERMINE THE DIRECTION.

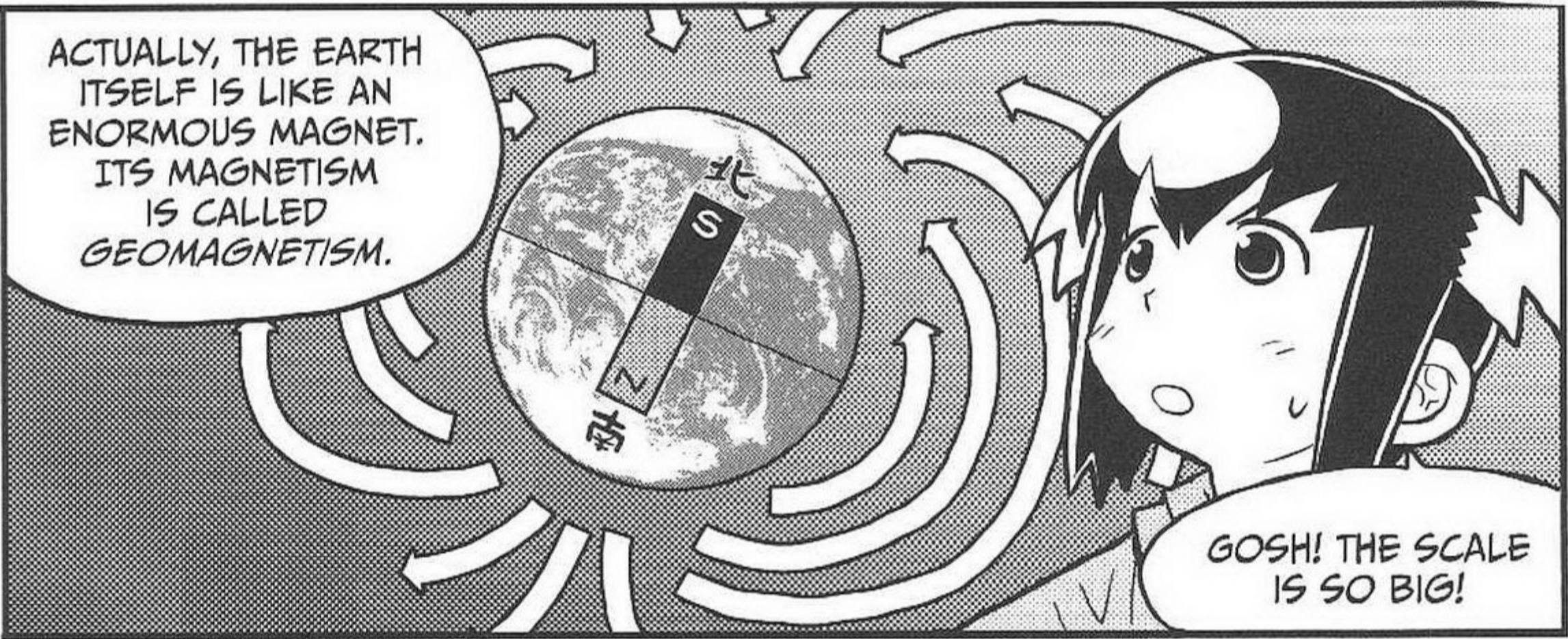

ACTUALLY, THE EARTH ITSELF IS LIKE AN ENORMOUS MAGNET. ITS MAGNETISM IS CALLED GEOMAGNETISM.

GOSH! THE SCALE IS SO BIG!

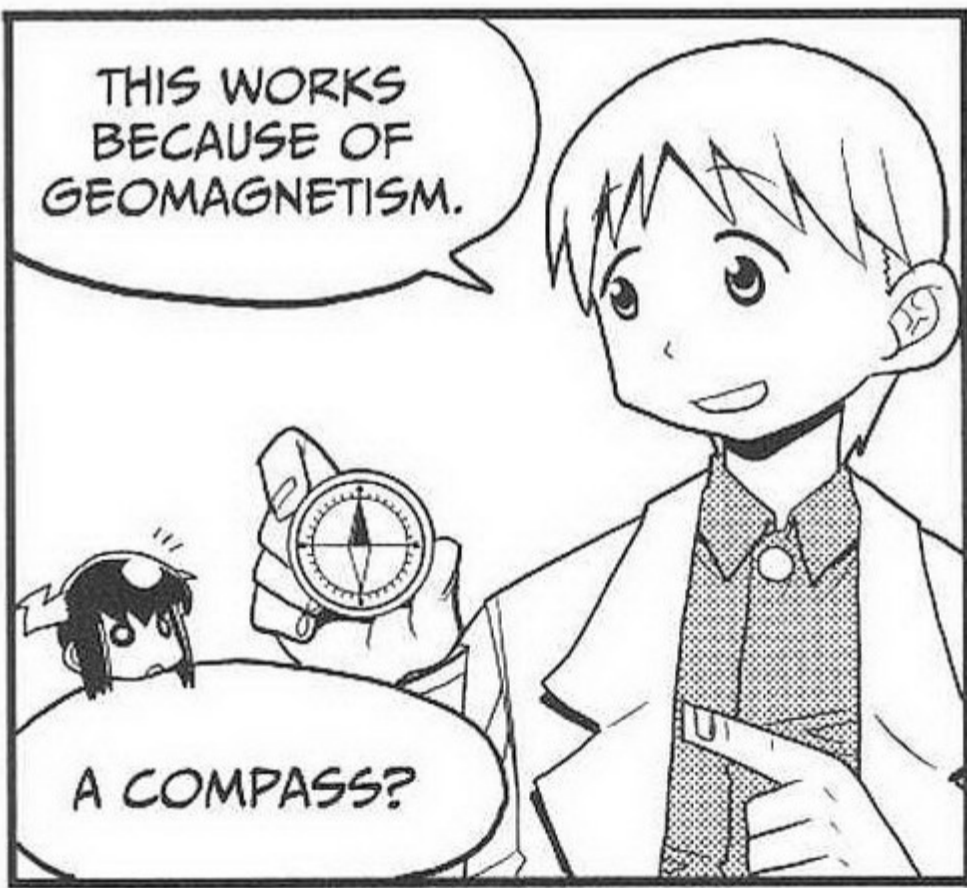

THIS WORKS BECAUSE OF GEOMAGNETISM.

A COMPASS?

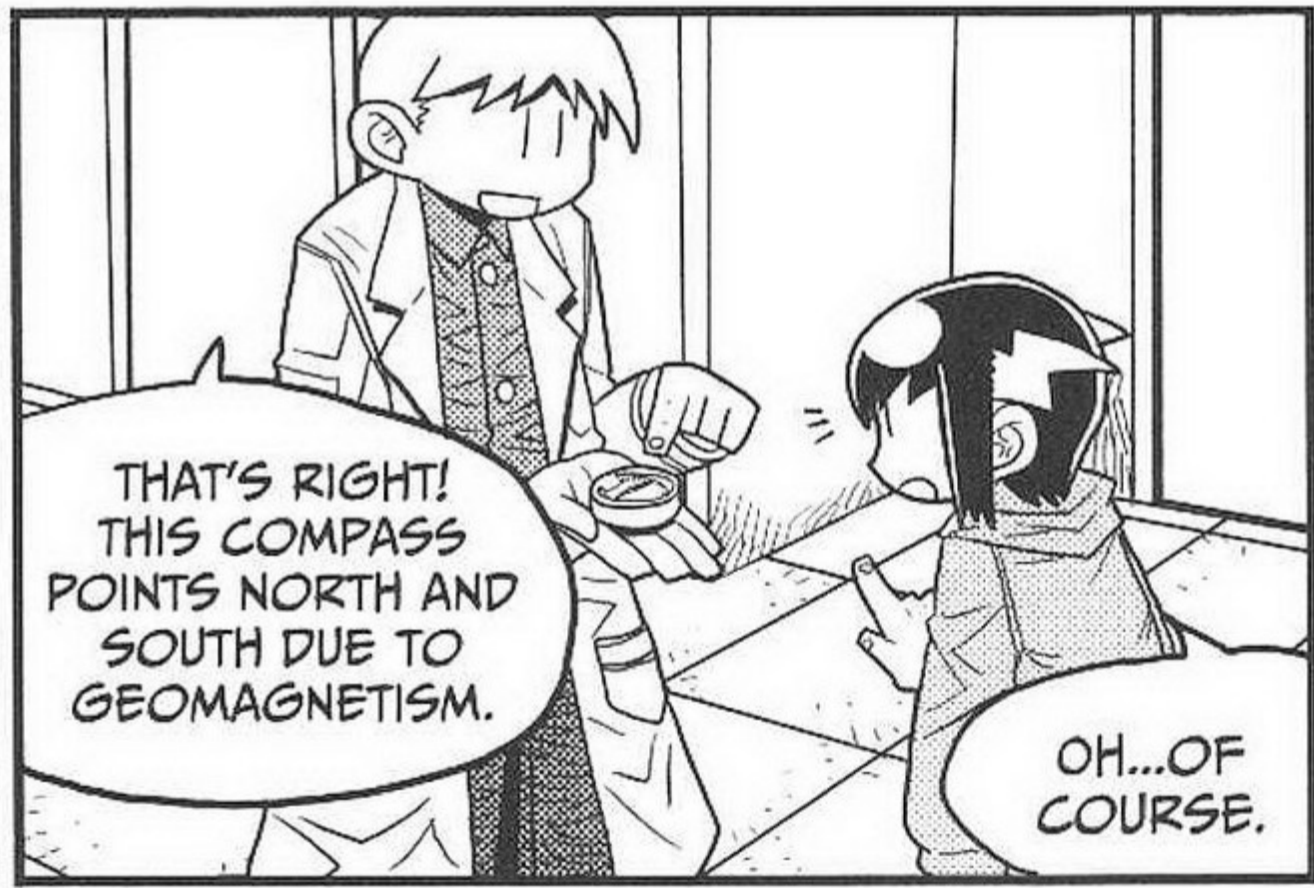

THAT'S RIGHT! THIS COMPASS POINTS NORTH AND SOUTH DUE TO GEOMAGNETISM.

OH...OF COURSE.

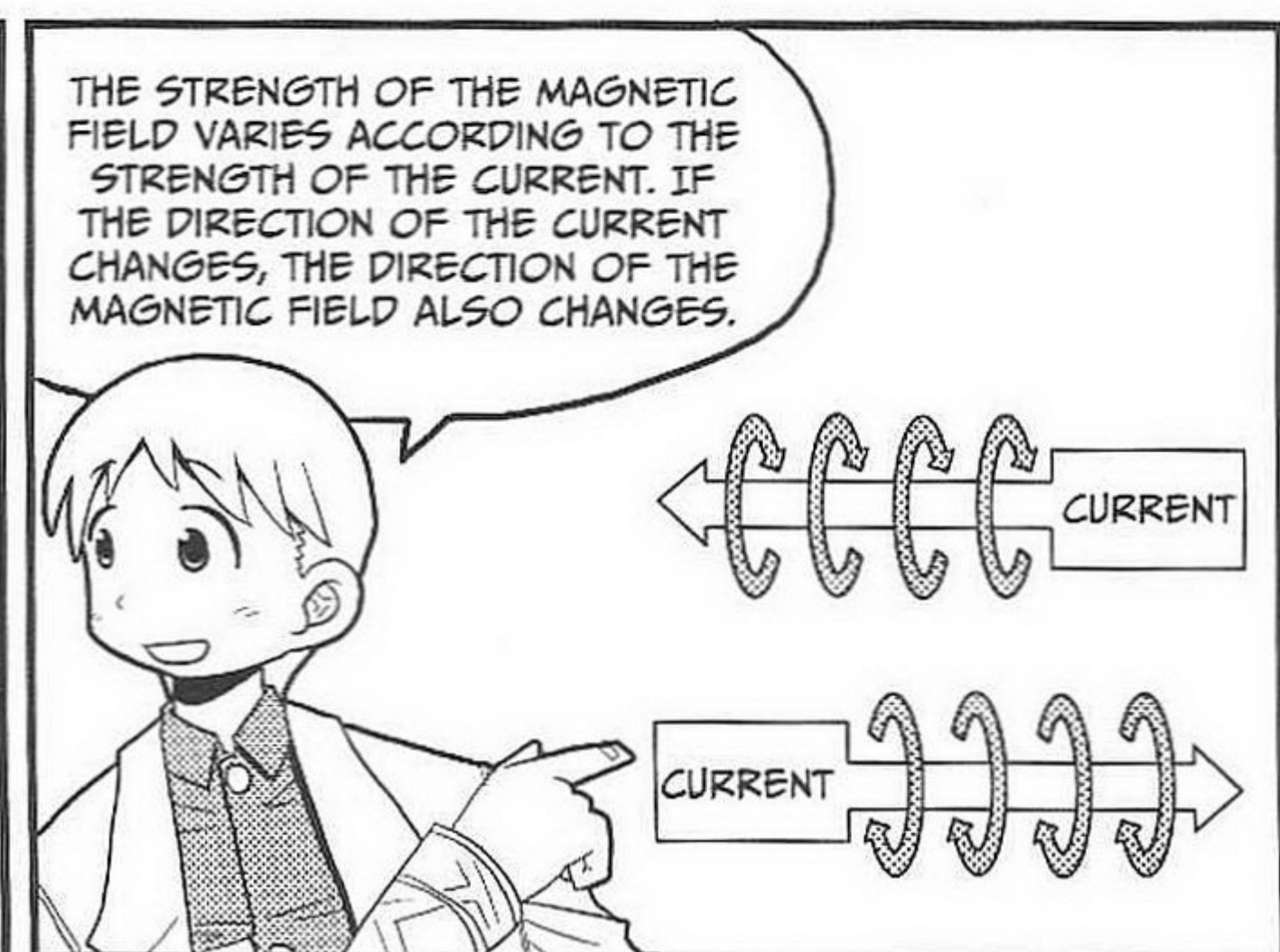
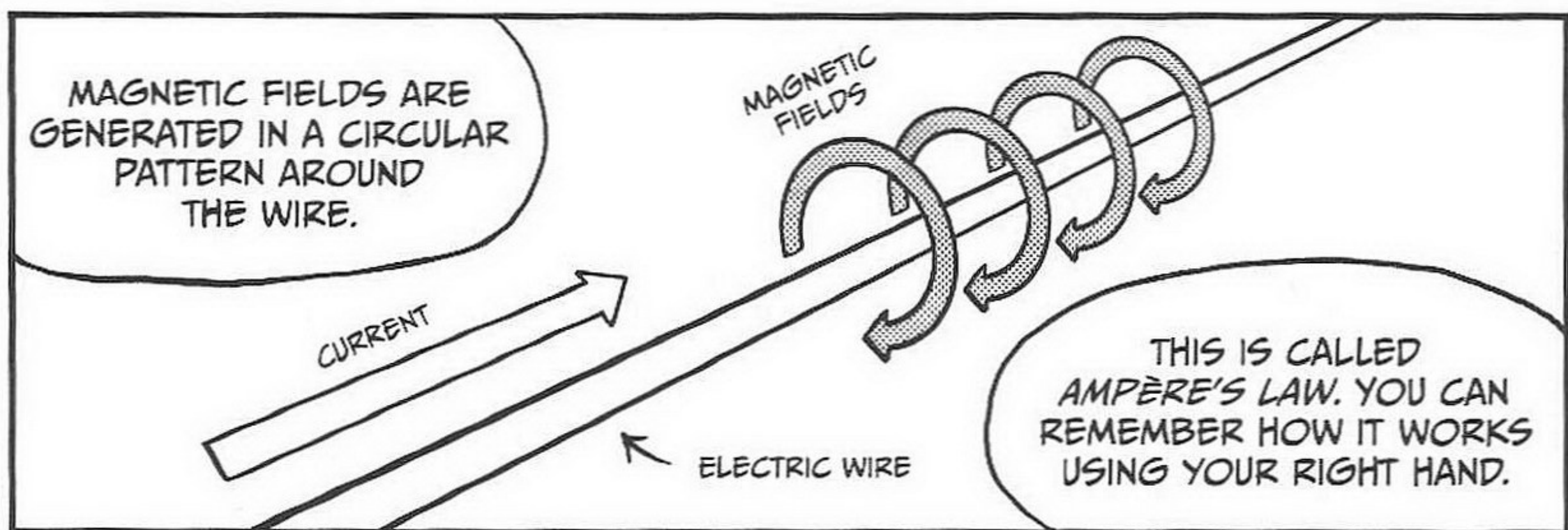
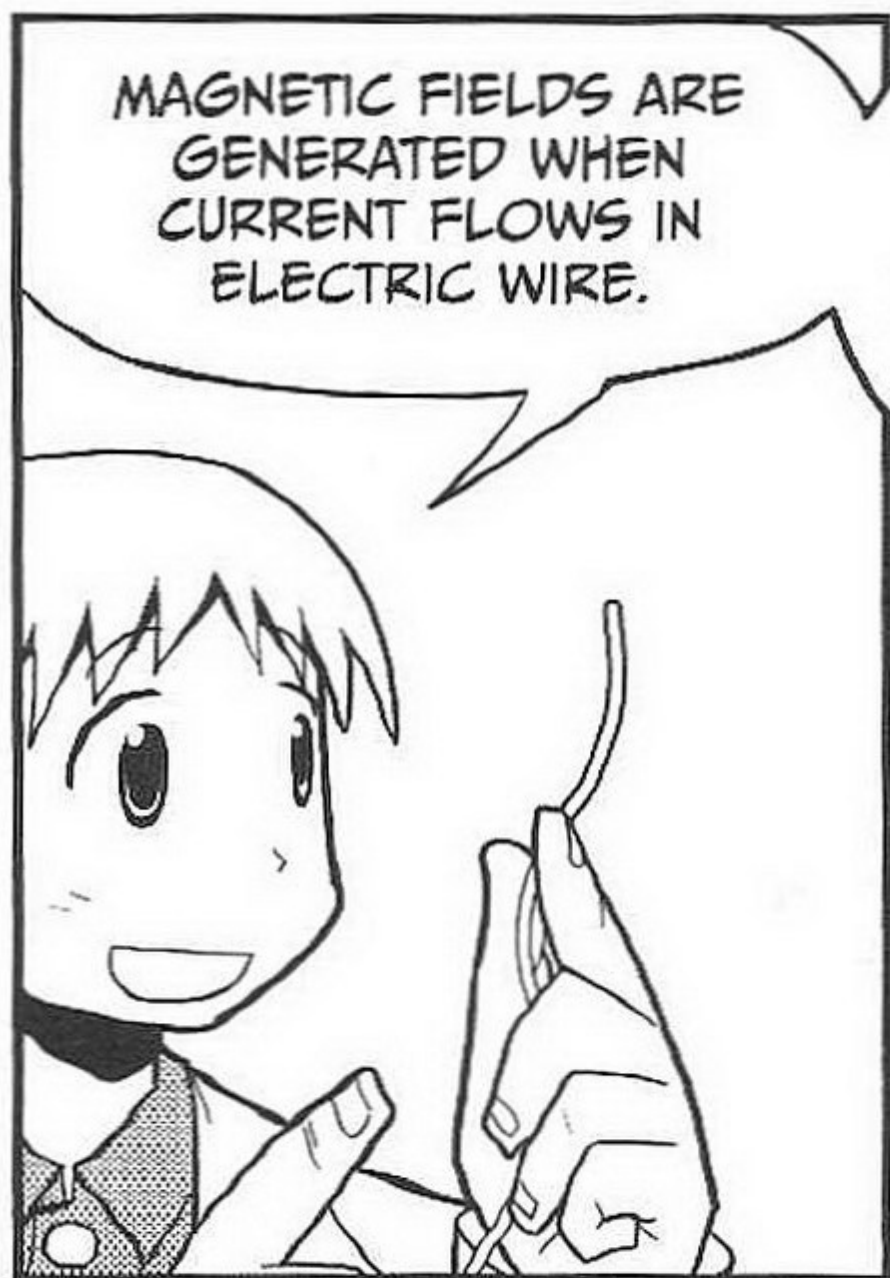

IF CURRENT OF THE SAME SIZE FLOWS IN THE SAME DIRECTION IN TWO ELECTRIC WIRES PLACED SIDE BY SIDE, TWO THINGS HAPPEN...

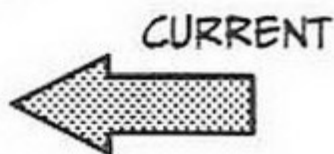

MAGNETIC FIELDS

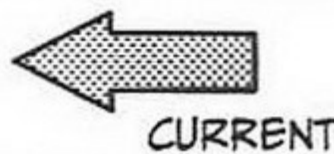

CURRENT

...THE TWO MAGNETIC FIELDS GENERATED IN THE TWO WIRES ARE COMBINED TO FORM ONE LARGE MAGNETIC FIELD. THIS ALSO WORKS FOR MORE THAN TWO WIRES.



↓ FORCE OF ATTRACTION IS GENERATED
↑

MAGNETIC FIELDS

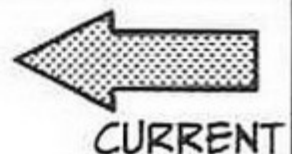

CURRENT

ADDITIONALLY, A FORCE OF ATTRACTION IS GENERATED THAT CAUSES THE TWO ELECTRIC WIRES TO ATTRACT EACH OTHER.

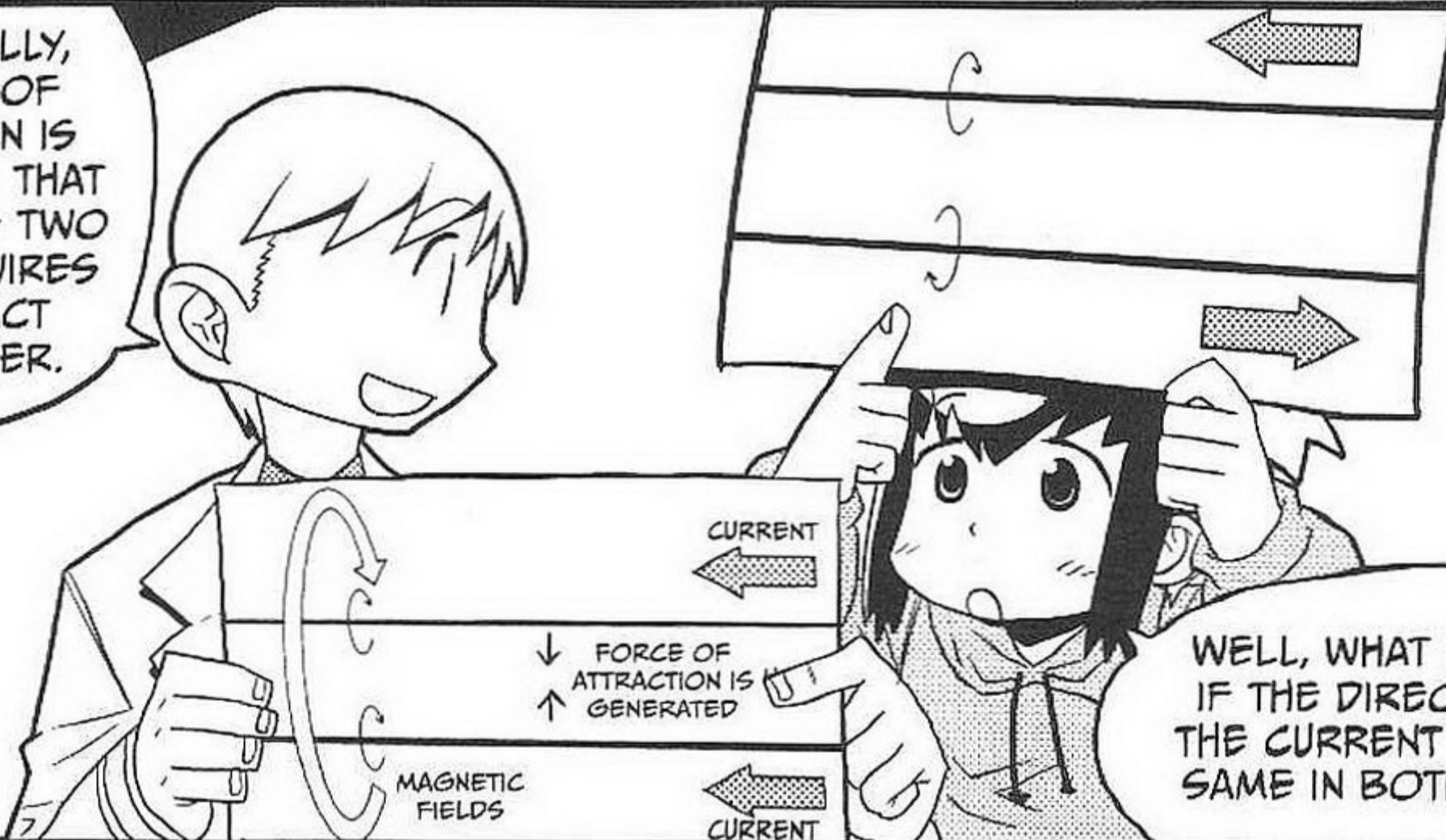

↓ FORCE OF ATTRACTION IS GENERATED
↑

MAGNETIC FIELDS

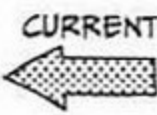

WELL, WHAT HAPPENS IF THE DIRECTION OF THE CURRENT ISN'T THE SAME IN BOTH WIRES?

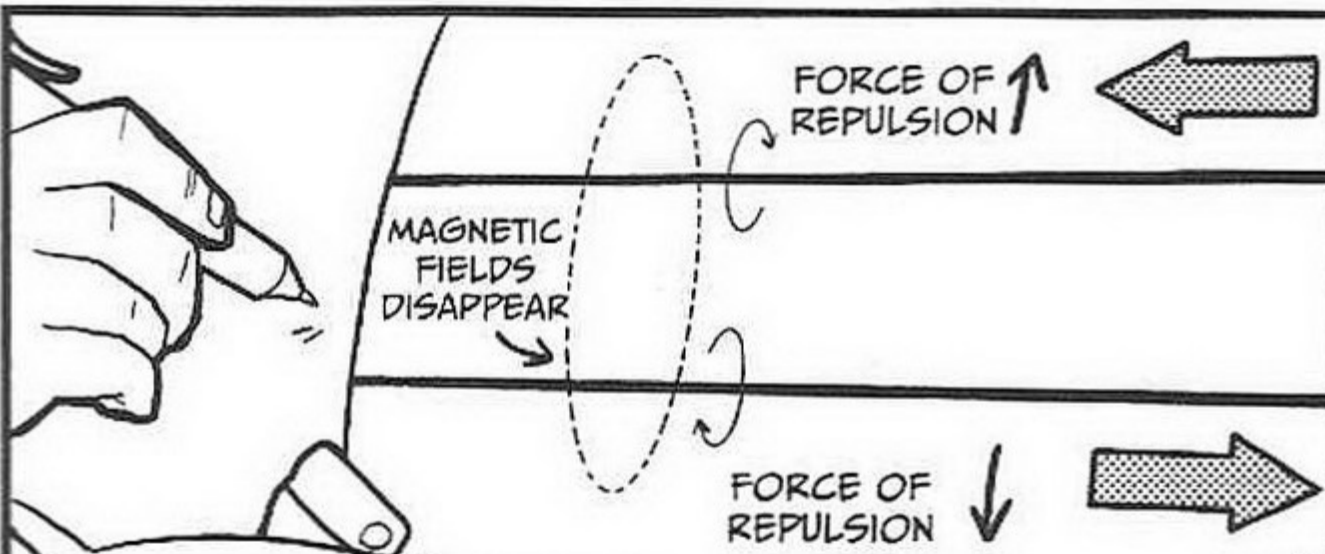

↑ FORCE OF REPULSION

MAGNETIC FIELDS DISAPPEAR

↓ FORCE OF REPULSION

IN THAT CASE, A FORCE OF REPULSION IS GENERATED IN THE WIRES, AND THE MAGNETIC FIELDS NEGATE EACH OTHER.

I CAN'T SEE...

OH! IF THE MAGNETIC FIELDS NEGATE EACH OTHER, THEY DISAPPEAR!

THAT'S RIGHT!

FLEMING'S LEFT-HAND RULE
(FOR DC MOTORS)

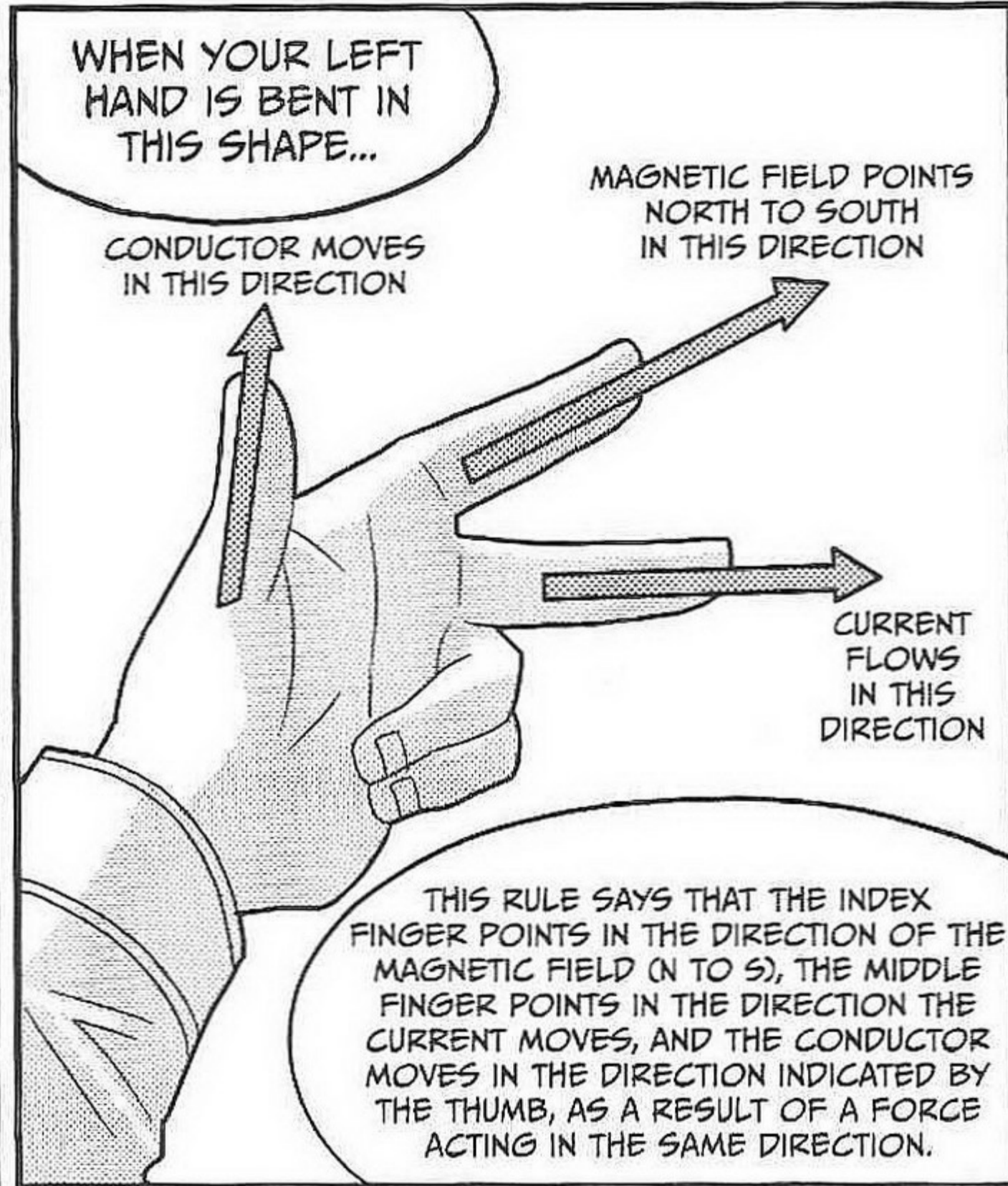
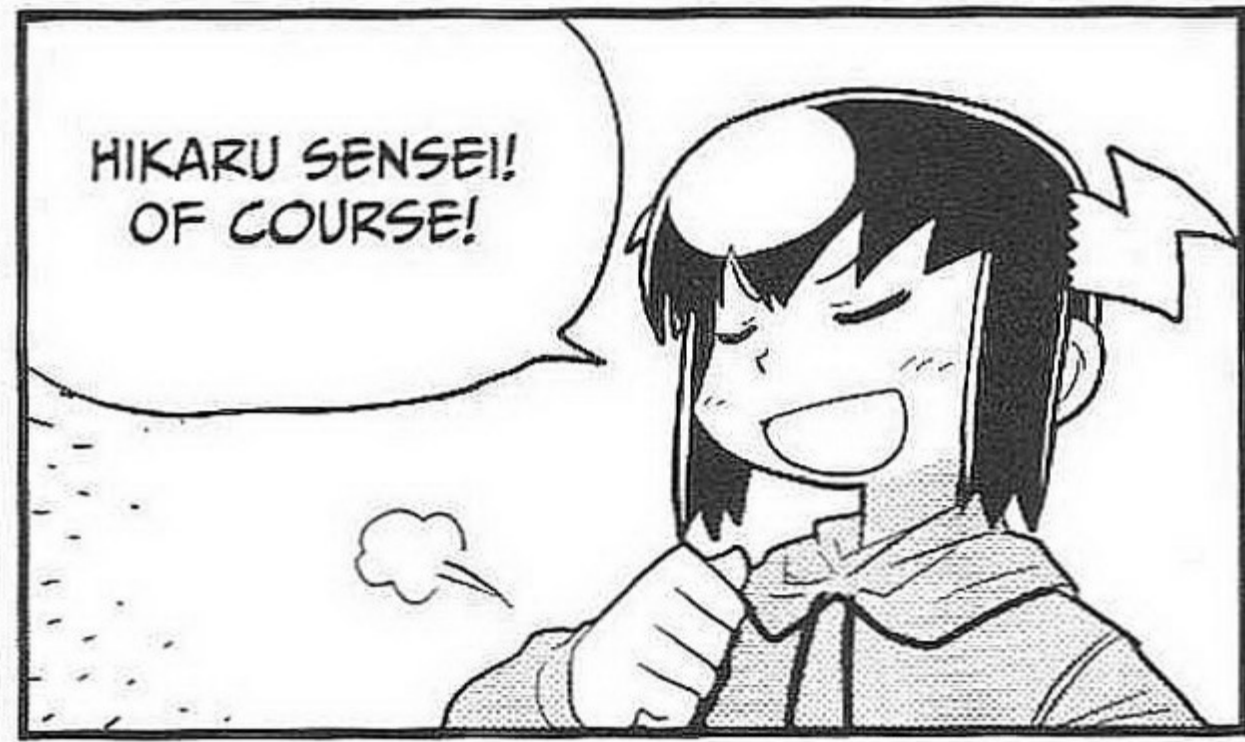

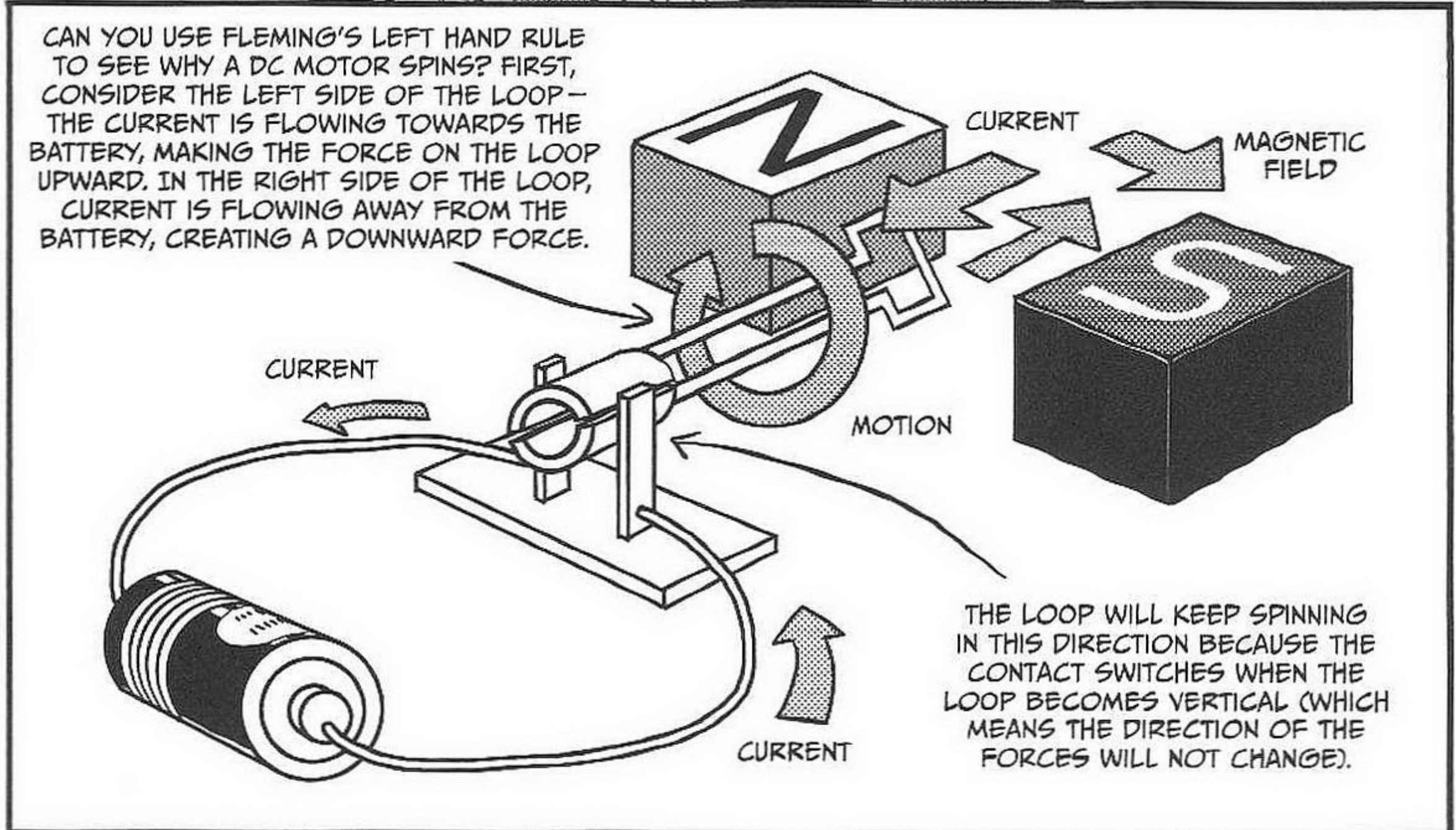
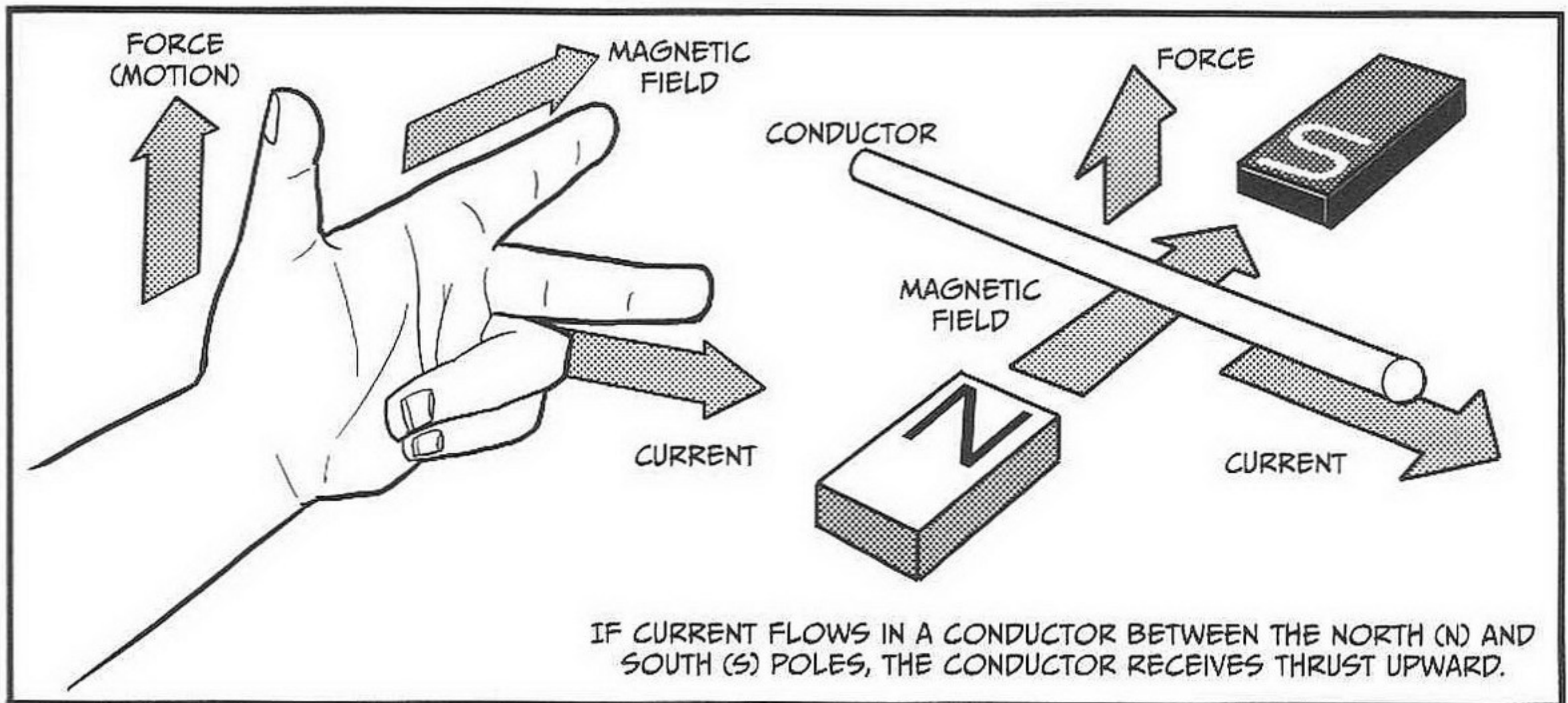

FLEMING'S RIGHT-HAND RULE (FOR GENERATORS)

FLEMING ALSO HAS A RIGHT-HAND RULE!

WHAT DOES THAT RULE SAY?

IF A CONDUCTOR MOVES BETWEEN THE POLES OF A MAGNET, THE CONDUCTOR CROSSES THROUGH A MAGNETIC FIELD.

MOTION OF THE CONDUCTOR

CONDUCTOR

MAGNETIC FIELD

OKAY...

AN ACTION THAT CAUSES ELECTRICITY TO FLOW, WHICH IS CALLED THE *ELECTROMOTIVE FORCE*, IS GENERATED IN THE CONDUCTOR AT THIS TIME, AND CURRENT FLOWS.

N-TO-S MAGNETIC FIELD POINTS IN THIS DIRECTION

CONDUCTOR MOVES IN THIS DIRECTION

CURRENT MOVES IN THIS DIRECTION

MOTION

CURRENT

THE FLOW OF THAT CURRENT IS IN THE DIRECTION OF THE MIDDLE FINGER OF THE RIGHT HAND, THE DIRECTION OF THE MAGNETIC FIELD IS THE DIRECTION OF THE INDEX FINGER, AND THE DIRECTION OF MOVEMENT OF THE ELECTRIC WIRE IS THE DIRECTION OF THE THUMB.

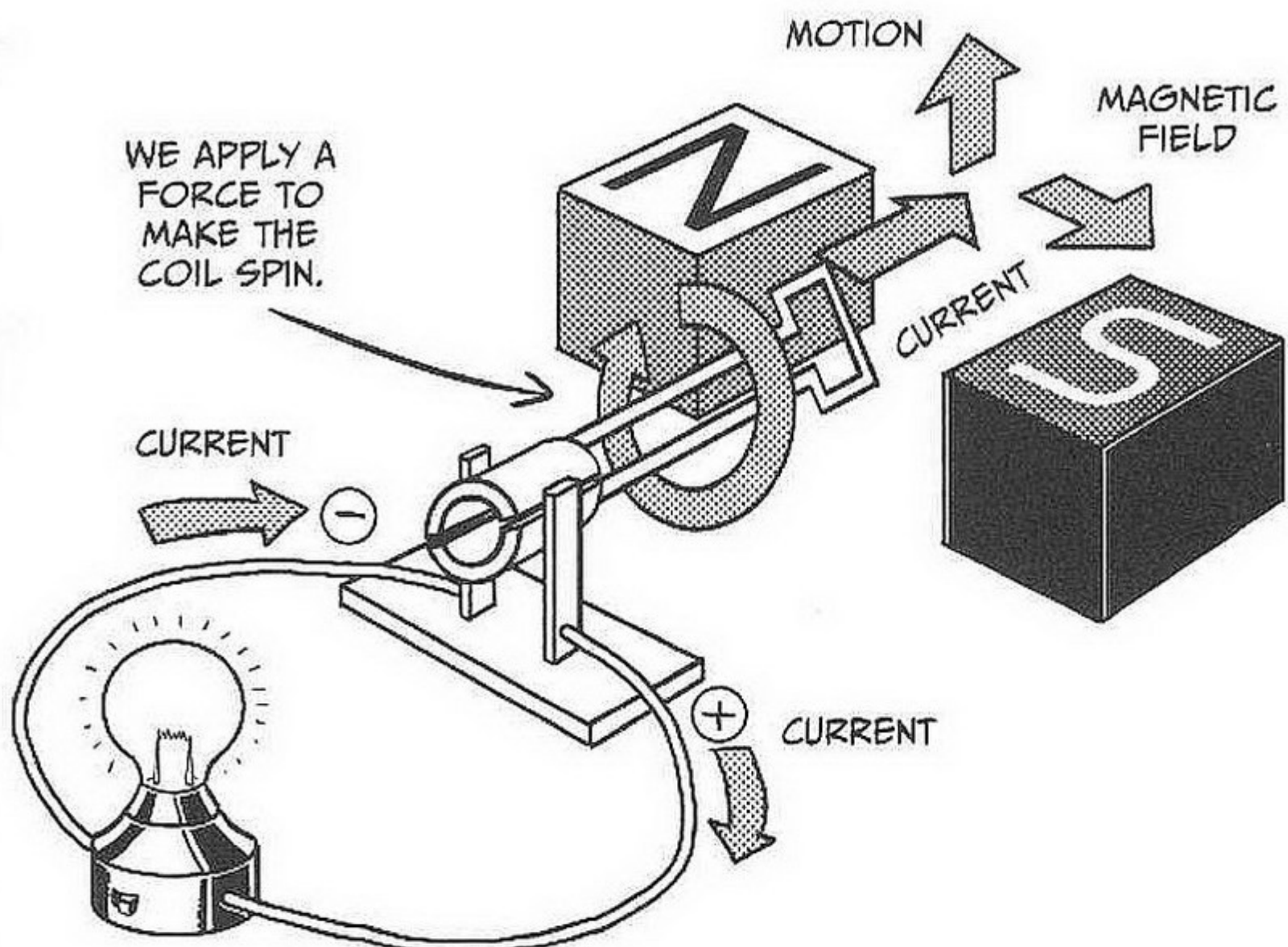

WHEN A GENERATOR CREATES ELECTRICITY, WE SIMPLY CONSIDER ONE SIDE OF THE LOOP (THE LEFT SIDE, ABOVE), AND WE CAN DETERMINE THE DIRECTION OF THE CURRENT USING FLEMING'S RIGHT-HAND RULE.



WE CAN USE THE RIGHT-HAND RULE TO DETERMINE THE DIRECTION OF THE CURRENT CREATED BY AN ELECTRIC GENERATOR...

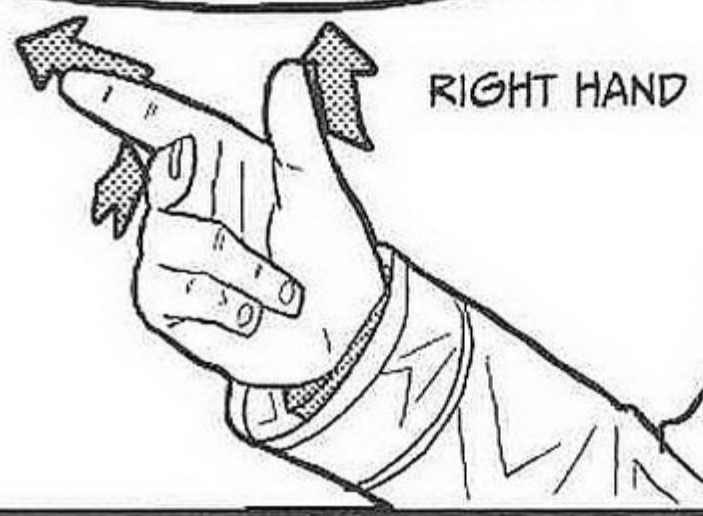

...AND USE THE LEFT-HAND RULE TO FIGURE OUT THE DIRECTION THAT A MOTOR TURNS.



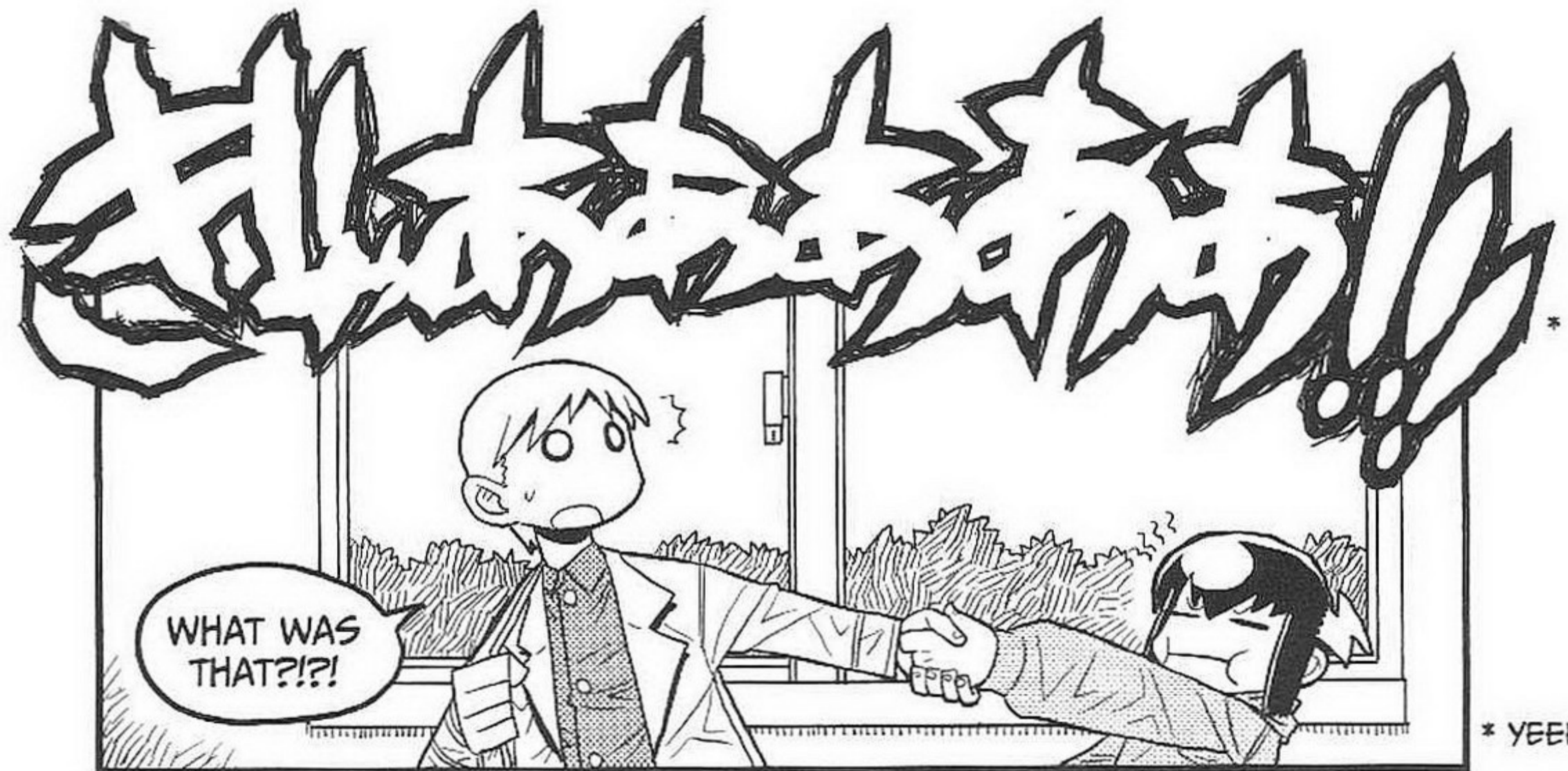

JOULE HEAT

Heat that is produced when current flows through an electric resistance is called *joule heat*. For example, the amount of heat produced when current I flows through resistance R for t seconds can be obtained by calculating $I^2 \times R \times t$. The amount of heat is represented by the symbol Q and is measured in *joules (J)*, which are named after the English physicist James Prescott Joule. One joule corresponds to the electric power consumption of 1Ws (watt second)—and one joule is equivalent to a $\text{kg} \times \text{m}^2 / \text{s}^2$. The amount of heat required to raise 1 gram of pure water from 14.5°C to 15.5°C at 1 atmosphere of pressure is approximately 4.2J, and this is equivalent to 1 *calorie (cal)*.

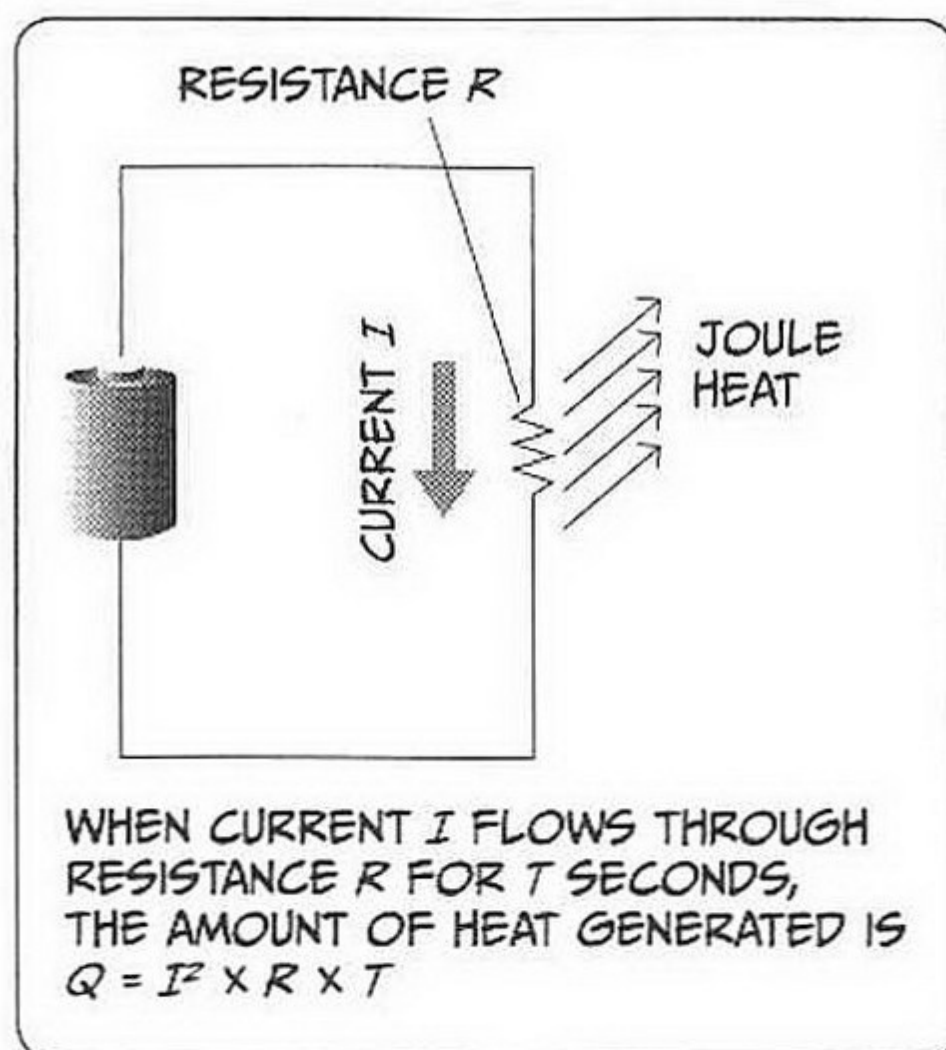

Resistance and joule heat

THERMAL VIBRATION

What is heat? The atoms that make up a substance are always vibrating, and this is called *thermal vibration*. The magnitude of the thermal vibration in a substance is directly related to the magnitude of the temperature of that substance—this thermal vibration of atoms is the true nature of heat.

If the atoms in a substance are not vibrating, that substance will have no temperature—that temperature is called *absolute zero*, which is equal to -273.15°C .

Even when copper wire, which is used for electric wire because of its low resistance, is at normal temperatures, the vibration of the copper atoms resists the movement of electrons, creating additional heat and additional resistance.

However, if the temperature of a material drops to near absolute zero, the vibrations of the atoms become very small. In such a state, electrons can travel much more easily—in other words, the material's resistance decreases. In some materials, such as aluminum, if the temperature becomes low enough, the electrons can move without

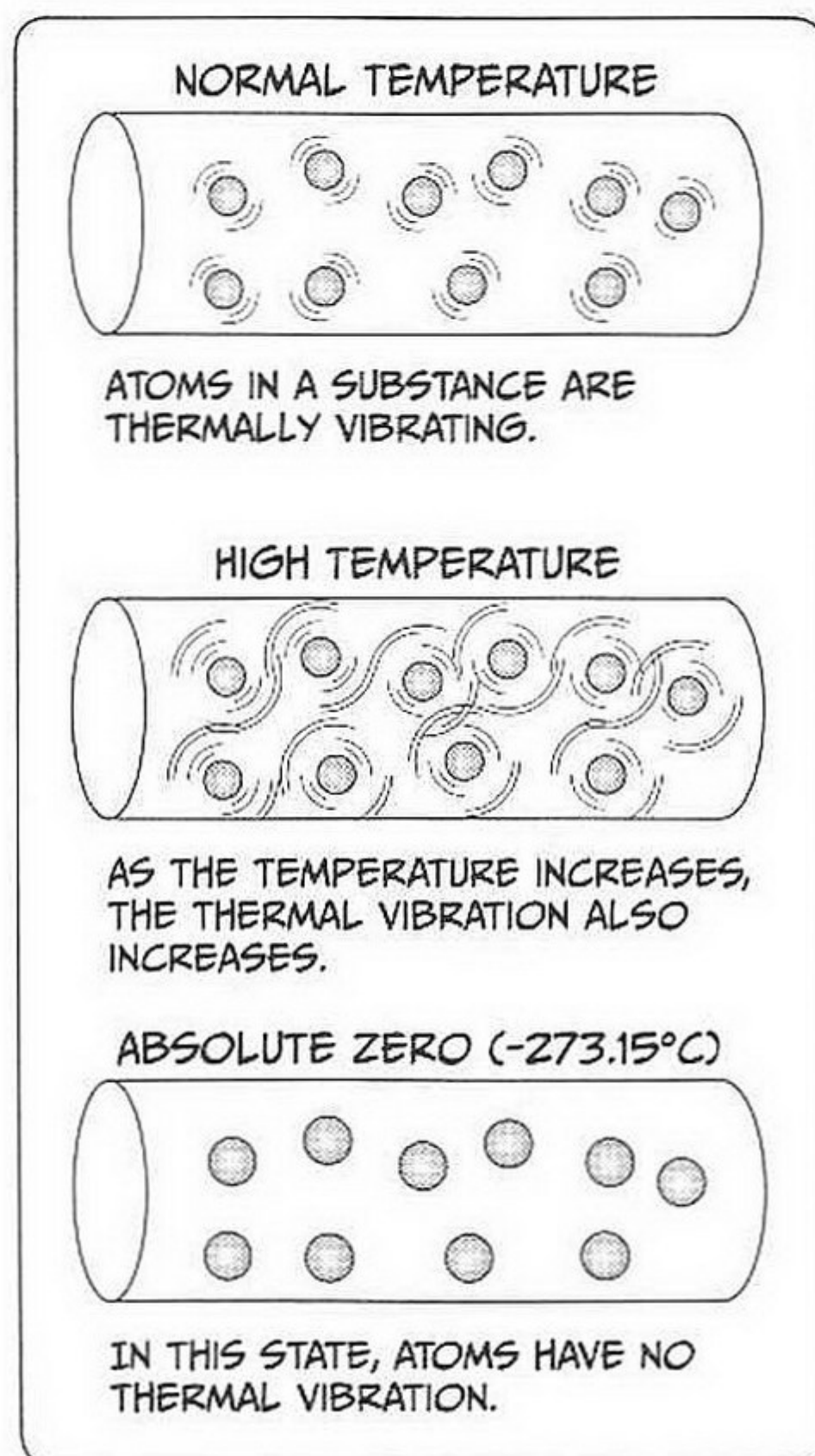

Thermal vibration and temperature

being obstructed by the atoms at all! When a material's resistance becomes zero, we call the phenomenon *superconductivity*.

Many metals are found to naturally superconduct when they are cold enough, but most need to be near absolute zero. However, since it is extremely difficult to actually lower a substance's temperature near absolute zero, research is being conducted on superconductivity phenomena that occur at temperatures much higher than absolute zero, a field called *high-temperature superconductors*. Someday, materials like these may be used to send electricity to homes everywhere without current loss due to joule heating.

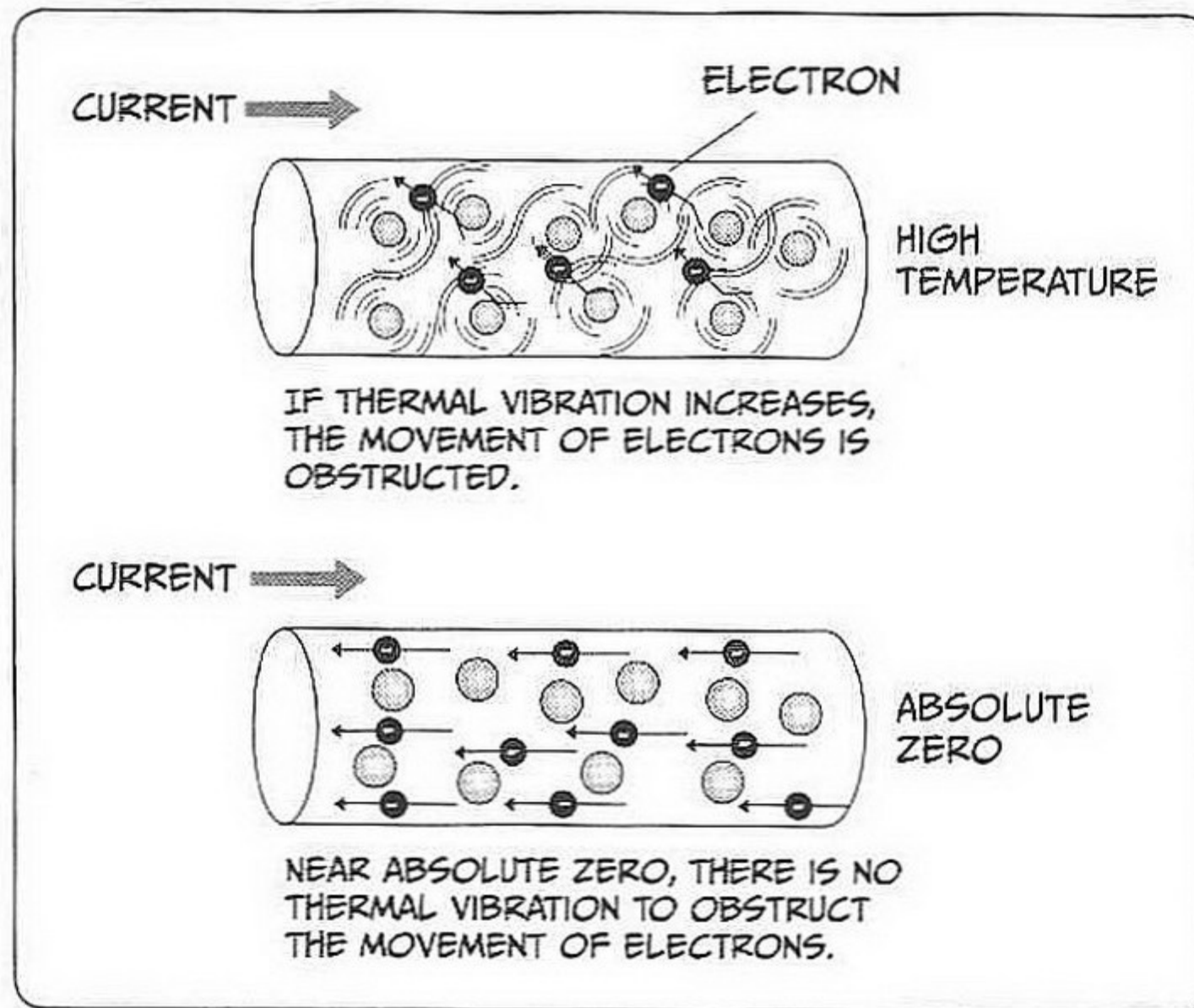

Superconductivity and current

In wires at normal temperatures, electrons will violently collide with other atoms, which creates even more thermal vibrations—that is, more heat. As a wire heats up, its resistance increases. Conversely, as its temperature decreases, electric resistance decreases.

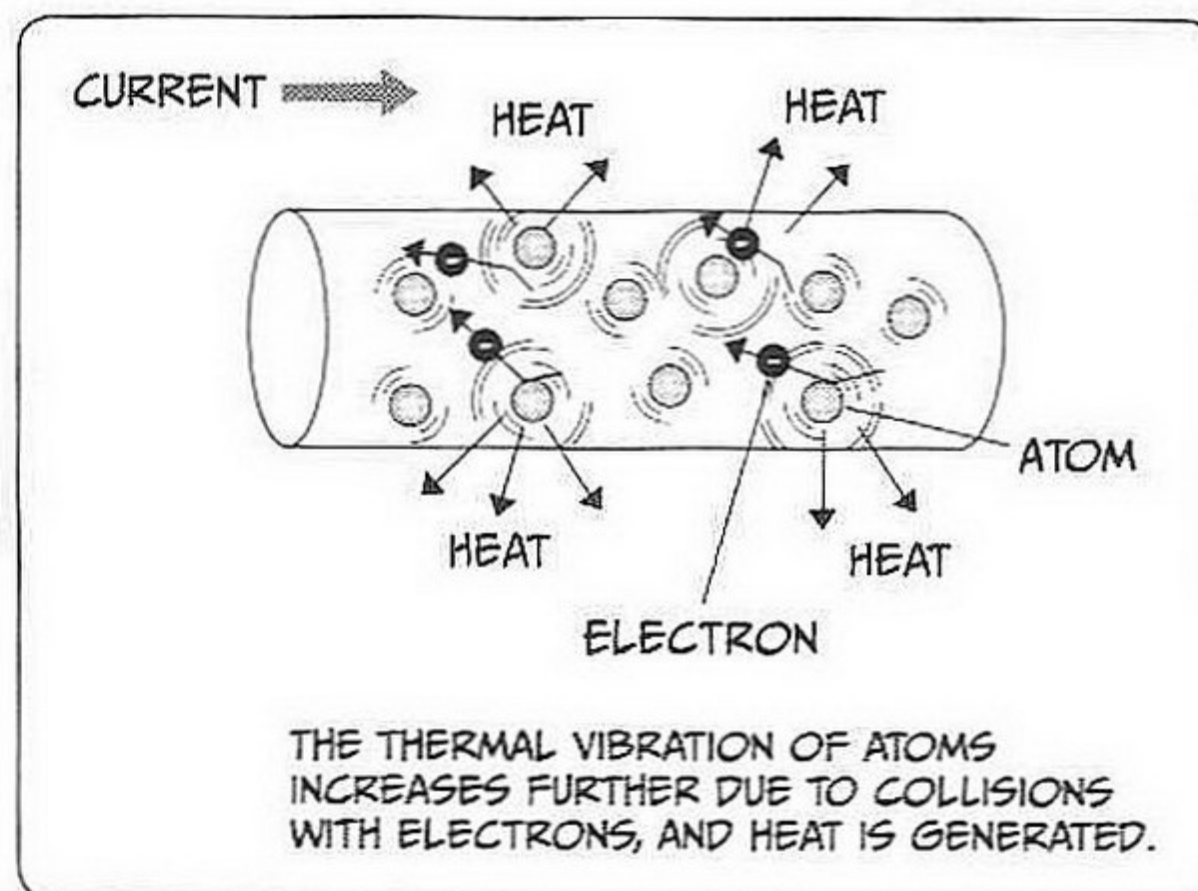

Collisions with electrons and generation of heat

ELECTROMAGNETIC WAVES

When current flows through a resistance and the temperature rises, heat is generated. At first, infrared rays that are invisible to the naked eye are emitted. *Infrared rays*, which are also called *heat rays*, are a type of *electromagnetic wave*—a wave that has thermal energy. Electromagnetic waves (in order of decreasing wavelength) include radio waves, infrared rays, visible light, ultraviolet rays, and X rays, among others. Radio waves are used for TV or radio broadcasting and communication for ships. The color of visible light varies with the wavelength—red light has the longest wavelength, and violet light has the shortest.

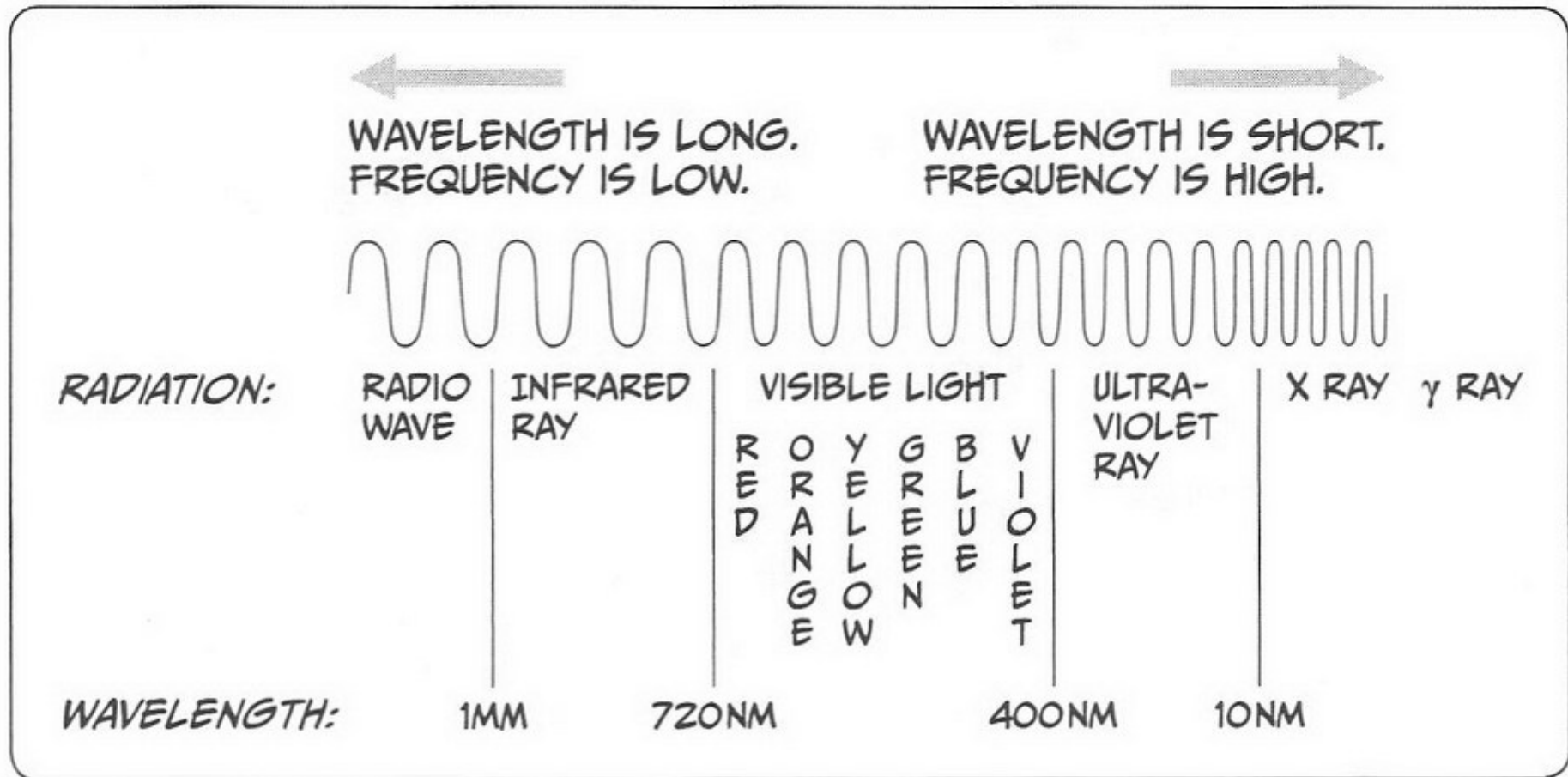

Wavelength and classification of electromagnetic waves

After infrared rays are emitted from a substance, visible light will be emitted if the temperature continues to rise. This phenomenon in which thermal energy is emitted as electromagnetic waves as the temperature of a substance increases is called *thermal emission*. This is the principle of light emission in light bulbs. Thermal emission produces red light at a low temperature, which changes to bluish white light as the temperature rises.

Light emission due to thermal emission mostly ends up becoming heat, so it is inefficient to use it as light. Light emission in which the emitter does not need to be heated is called *luminescence*; it is the principle used in fluorescent lights. In a fluorescent light, electrons that escape from the filament collide with mercury vapor inside the fluorescent tube; the ultraviolet rays that are generated at that time excite the fluorescent substance on the inner surface of the fluorescent tube and become visible light. The light emission of a fluorescent light is very efficient—for the same electric power consumption, it emits more than four times the light that a regular light bulb emits.

Light-emitting phenomena include thermal emission and luminescence, as shown here.

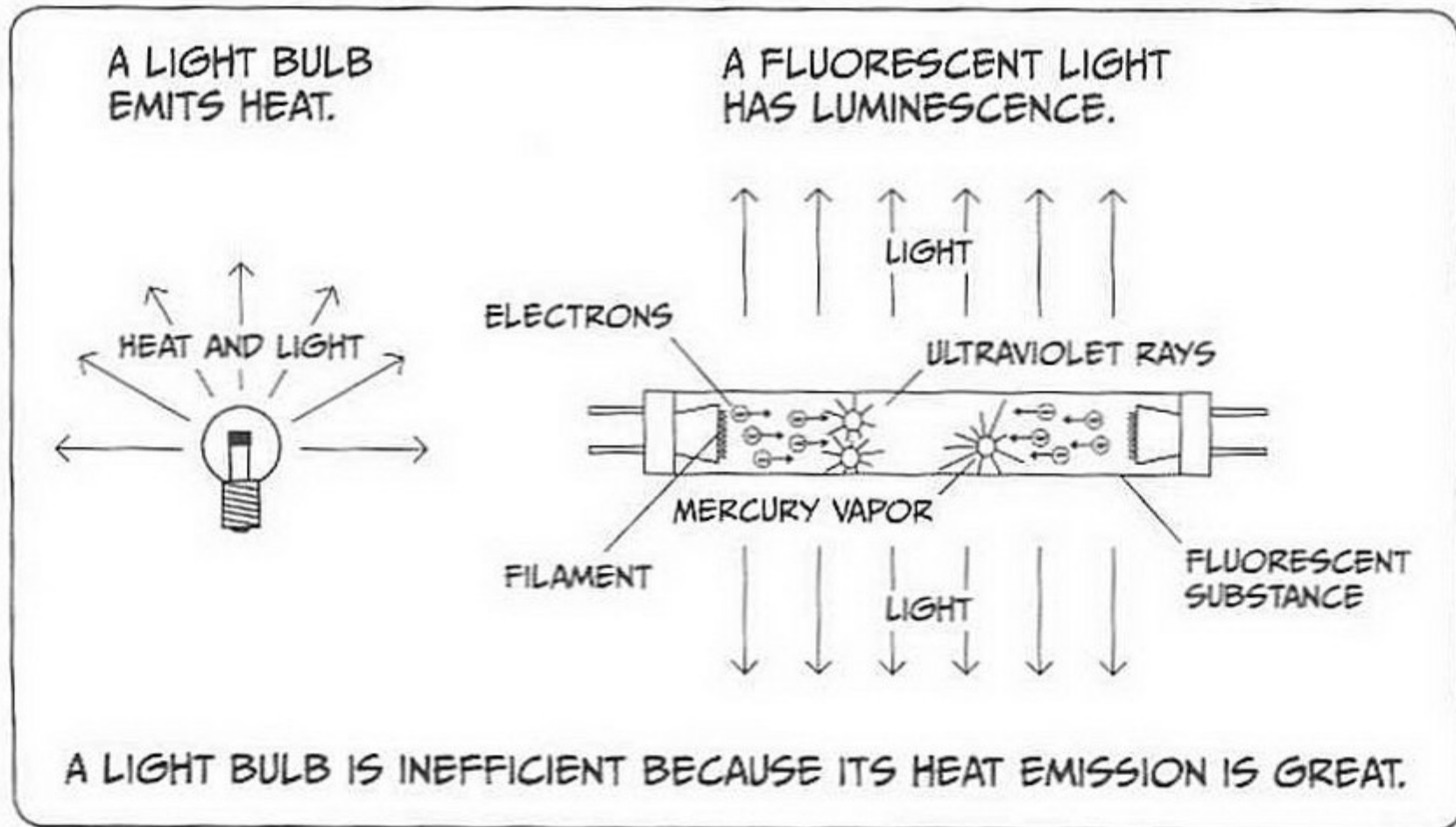

Light emission of a light bulb and a fluorescent tube

ELECTRICITY AND MAGNETISM

If iron filings are sprinkled on a sheet of paper placed over a bar magnet, a pattern of lines is produced. These lines originate from the north (N) pole and lead toward the south (S) pole; they are called a *magnetic field*.

Magnetic fields are also generated when current flows. This phenomenon is extremely important when using electricity, and many common electrical appliances make use of it.

When current flows in an electric wire, a magnetic field with a circular pattern is generated around that wire. This is called *Ampère's law*. The magnitude of this magnetic field varies according to the strength of the current; if the direction of the current changes, the direction of the magnetic field also changes.

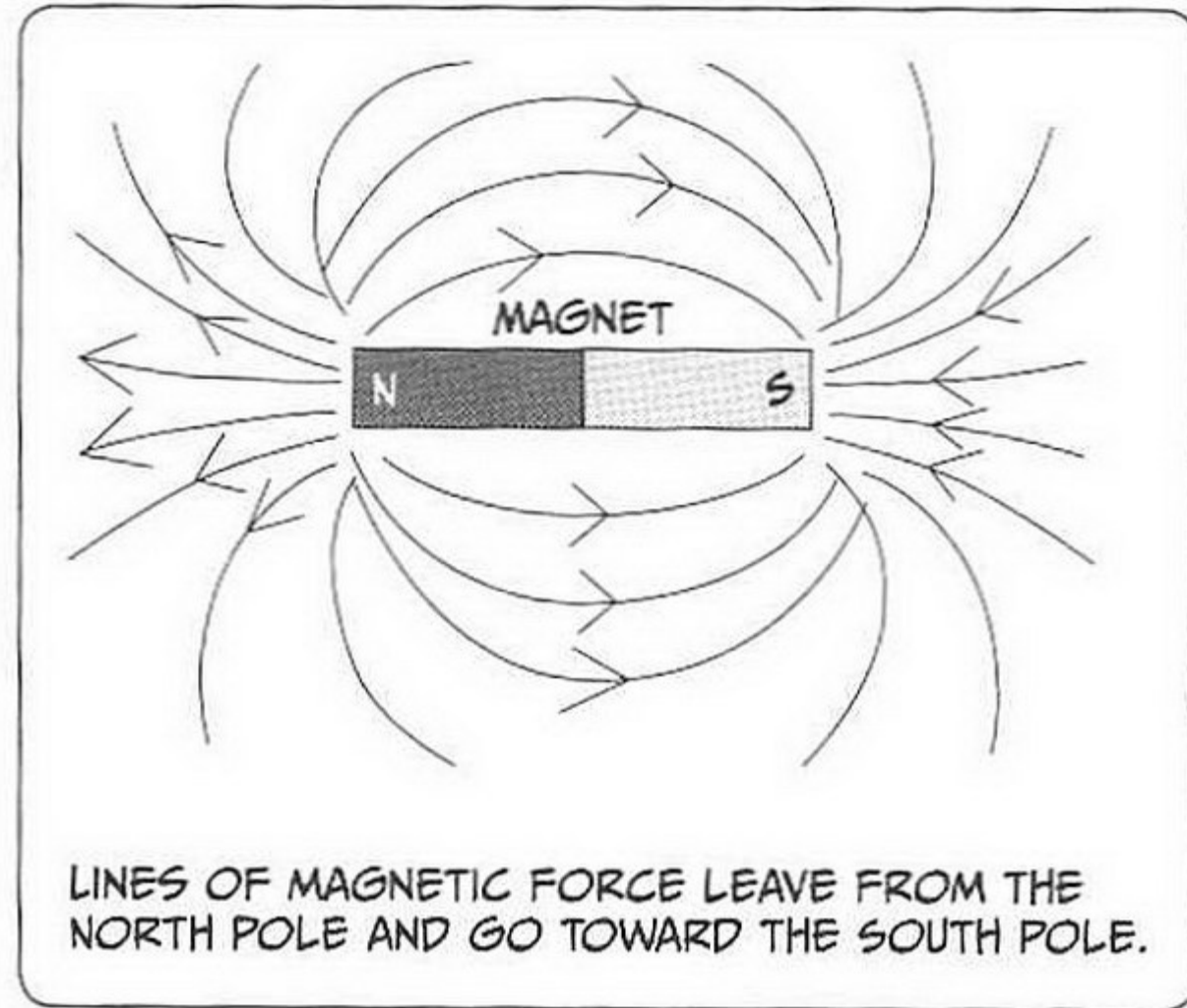

A magnet and magnetic fields

If current of the same magnitude flows in the same direction in two electric wires placed side by side, the magnetic fields generated in each wire are combined to generate a magnetic field of twice the current around both conductors. At this time, a force of attraction is generated between the two electric wires. If current is flowing in opposite directions in two wires, a force of repulsion is generated between the wires. In this case, the magnetic fields around the wires negate each other and become smaller.

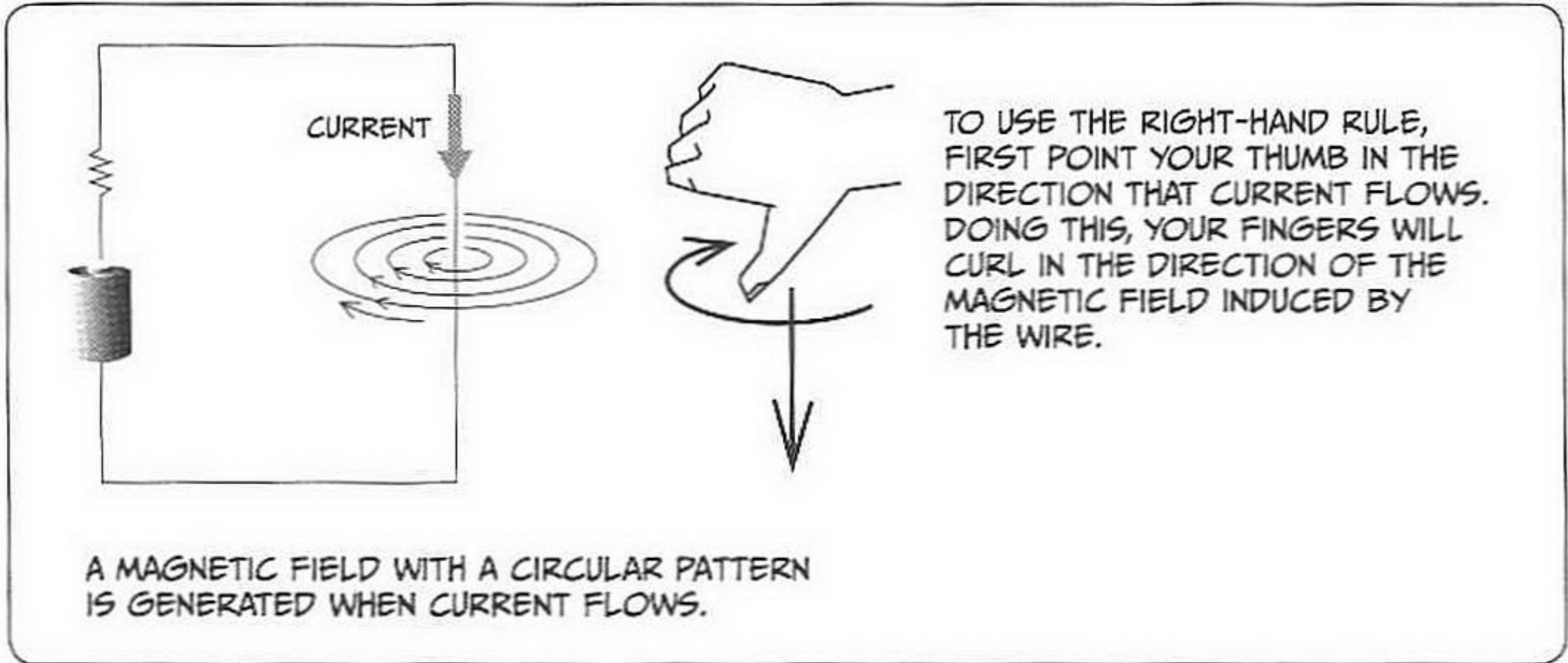

Ampère's law

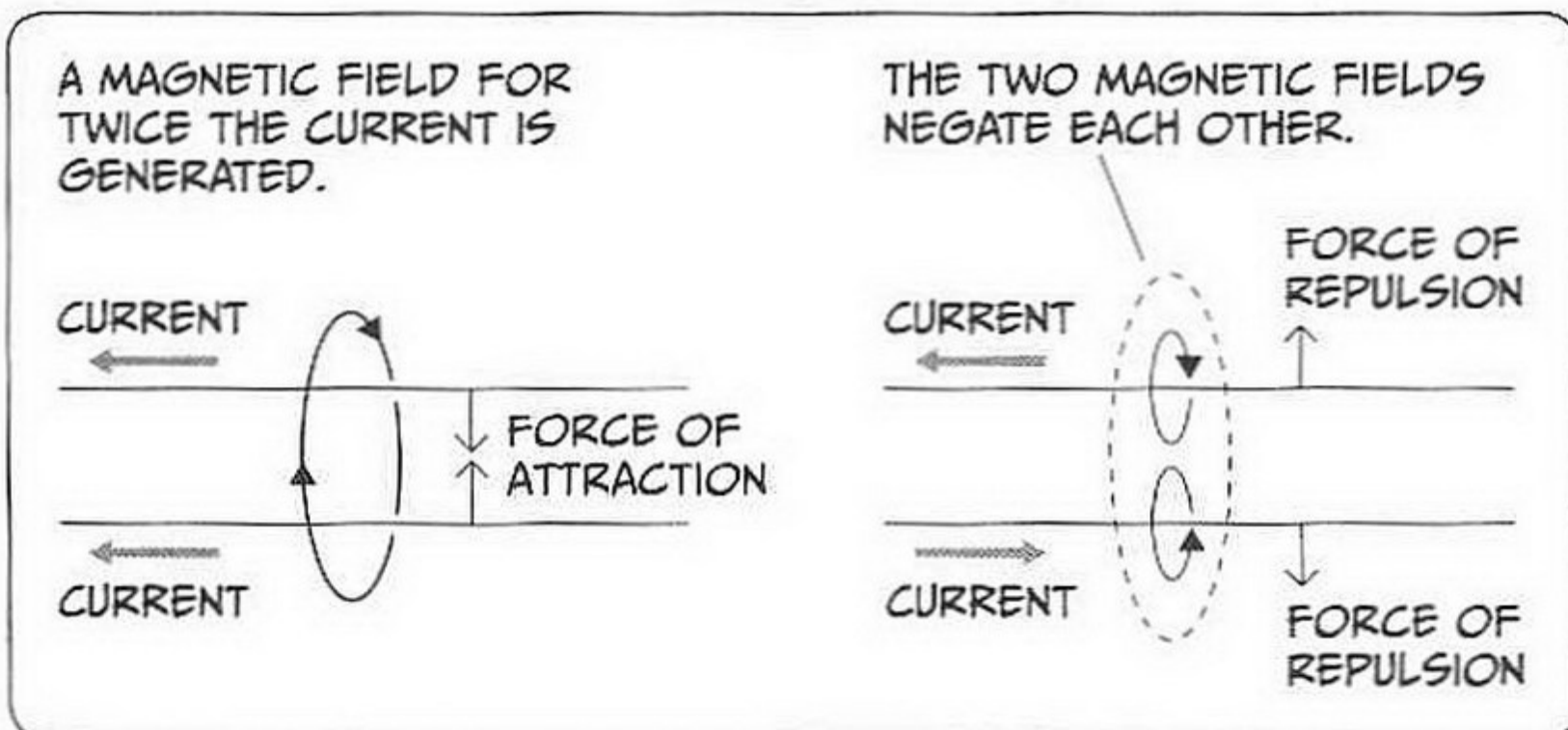

Forces generated when current flows in two conductors

The additive property of magnetic fields also holds true for more than two wires (for example, a coil). In this way, a large magnetic field can be generated.

FLEMING'S LEFT-HAND RULE AND MOTORS

If current flows in a conductor that is within a magnetic field, an *electromagnetic force* is generated on the conductor. *Fleming's left-hand rule* indicates an easy-to-remember relationship among the directions of the magnetic field, the current, and the movement of the conductor. This rule says that when you extend the thumb, index finger, and middle finger of your left hand so they are mutually perpendicular, the index finger points in the direction of the magnetic field, the middle finger points in the direction of the current, and the thumb points in the direction that the conductor moves (the direction of the electromagnetic force). The name of this rule comes from the name of the English electrical engineer John Ambrose Fleming who defined it. You can determine the direction of rotation of a motor by using Fleming's left-hand rule.

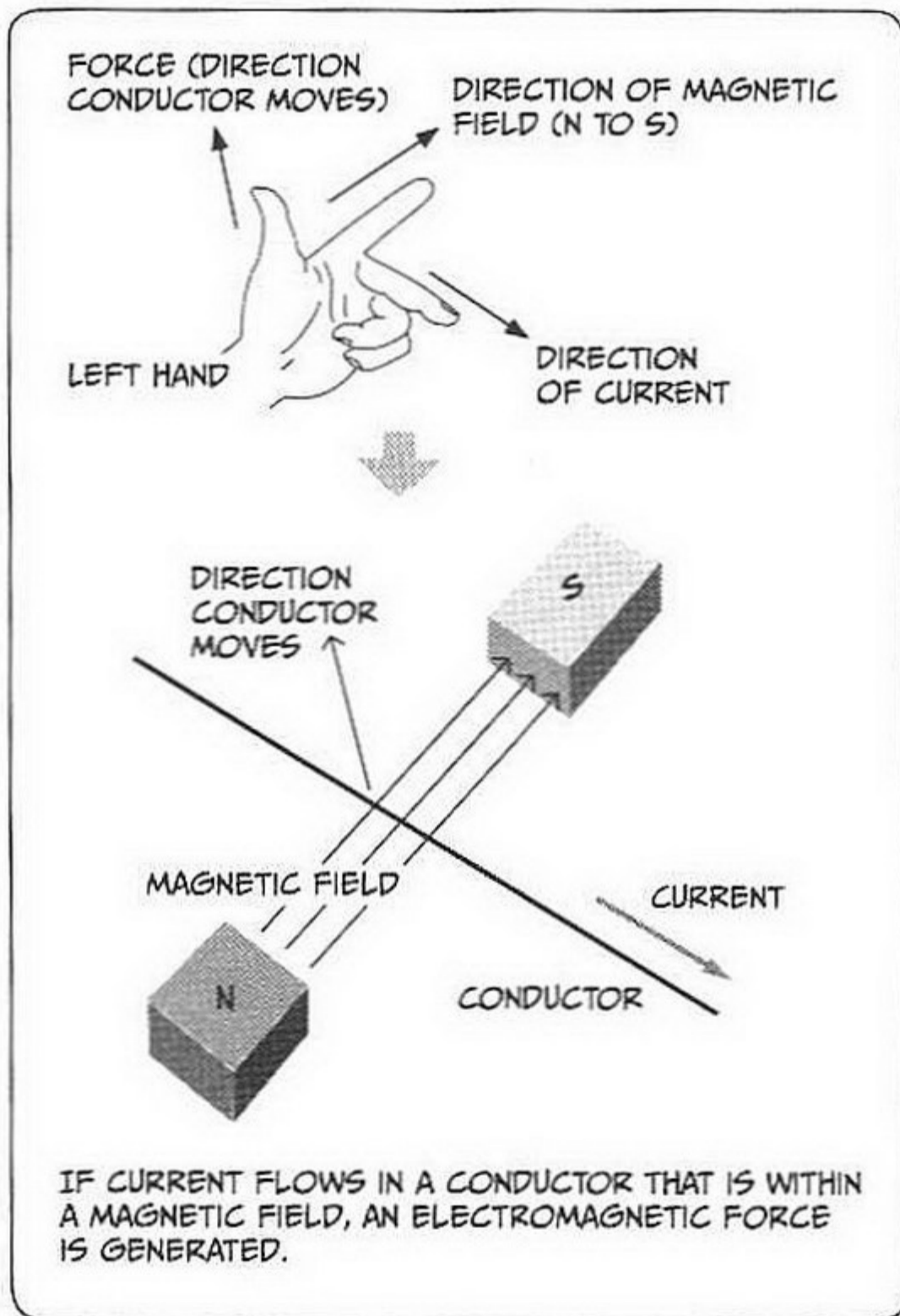

Fleming's left-hand rule

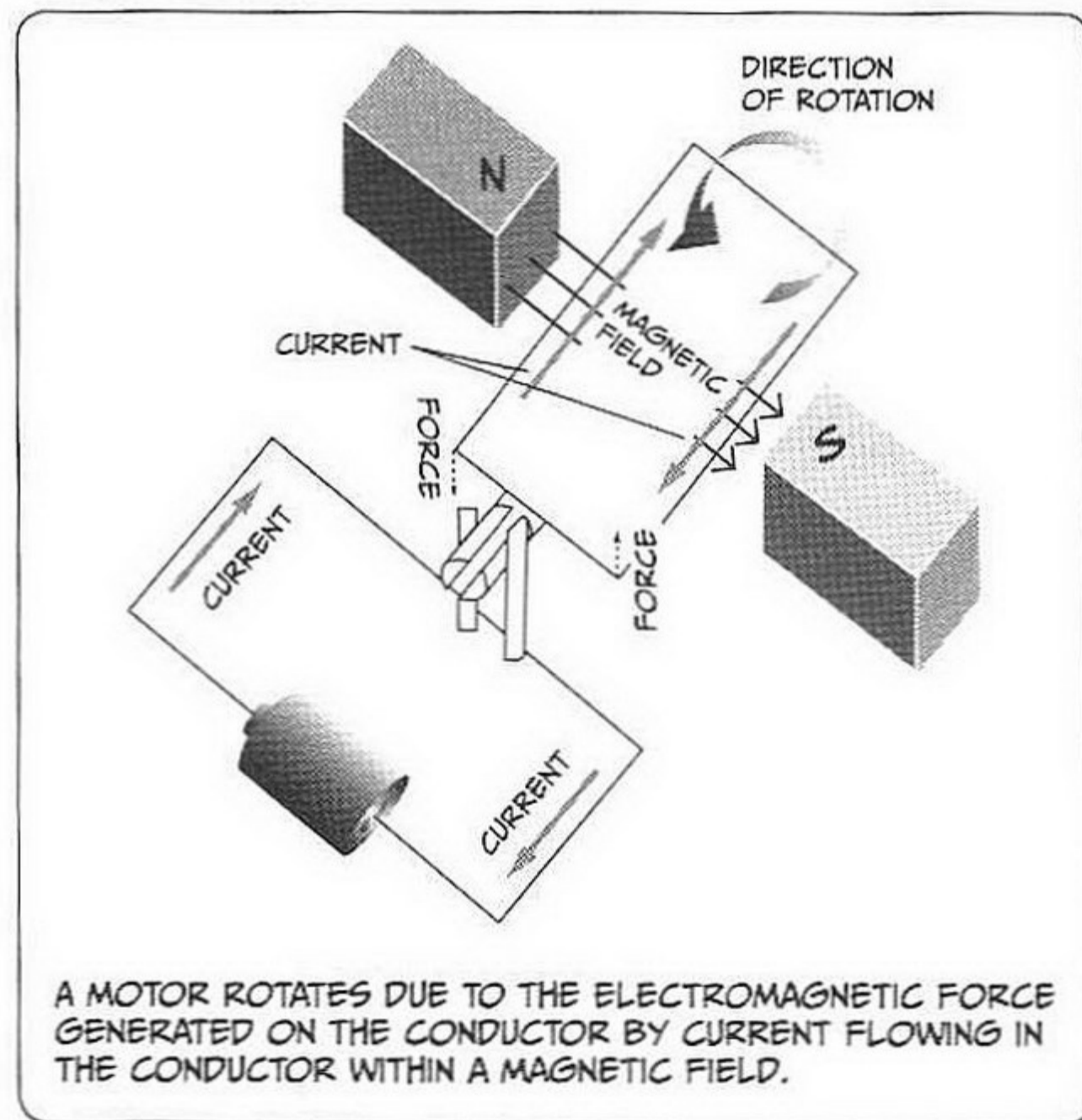

Motor rotation

FLEMING'S RIGHT-HAND RULE AND ELECTRIC GENERATORS

You can determine the direction of the electromotive force created by an electric generator by using *Fleming's right-hand rule*. When a conductor moves between the poles of a magnet, the conductor crosses a magnetic field facing from the north (N) pole to the south (S) pole of the magnet; electromotive force is thus generated in the conductor, and current flows. *Fleming's right-hand rule* indicates an easy-to-remember relationship among the directions of the magnetic field, the movement of the conductor, and the current. When you extend the thumb, index finger, and middle finger of your right hand so they are mutually perpendicular, the index finger points in the direction of the magnetic field, the thumb points in the direction that the conductor moves, and the middle finger points in the direction of the current.

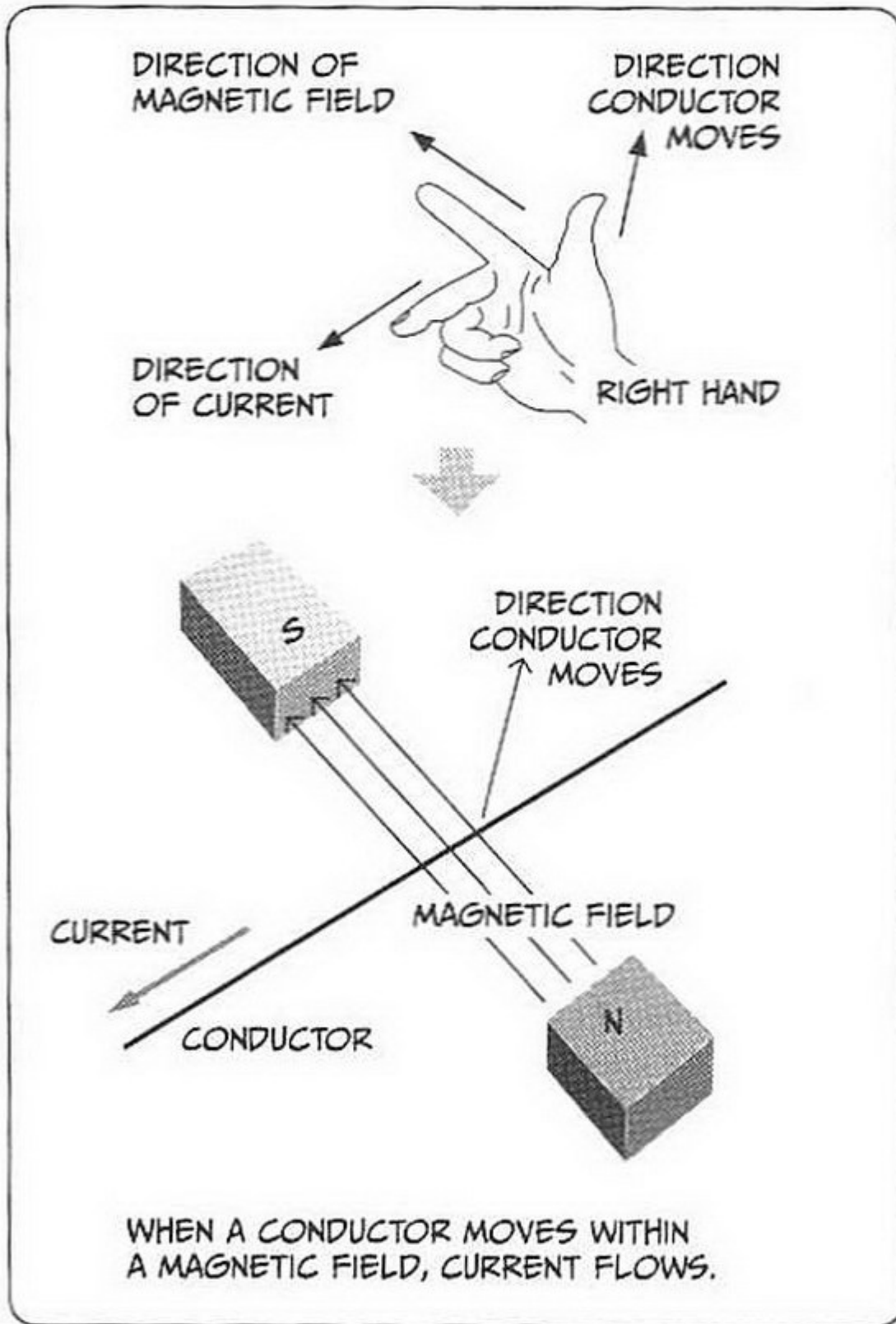

Fleming's right-hand rule

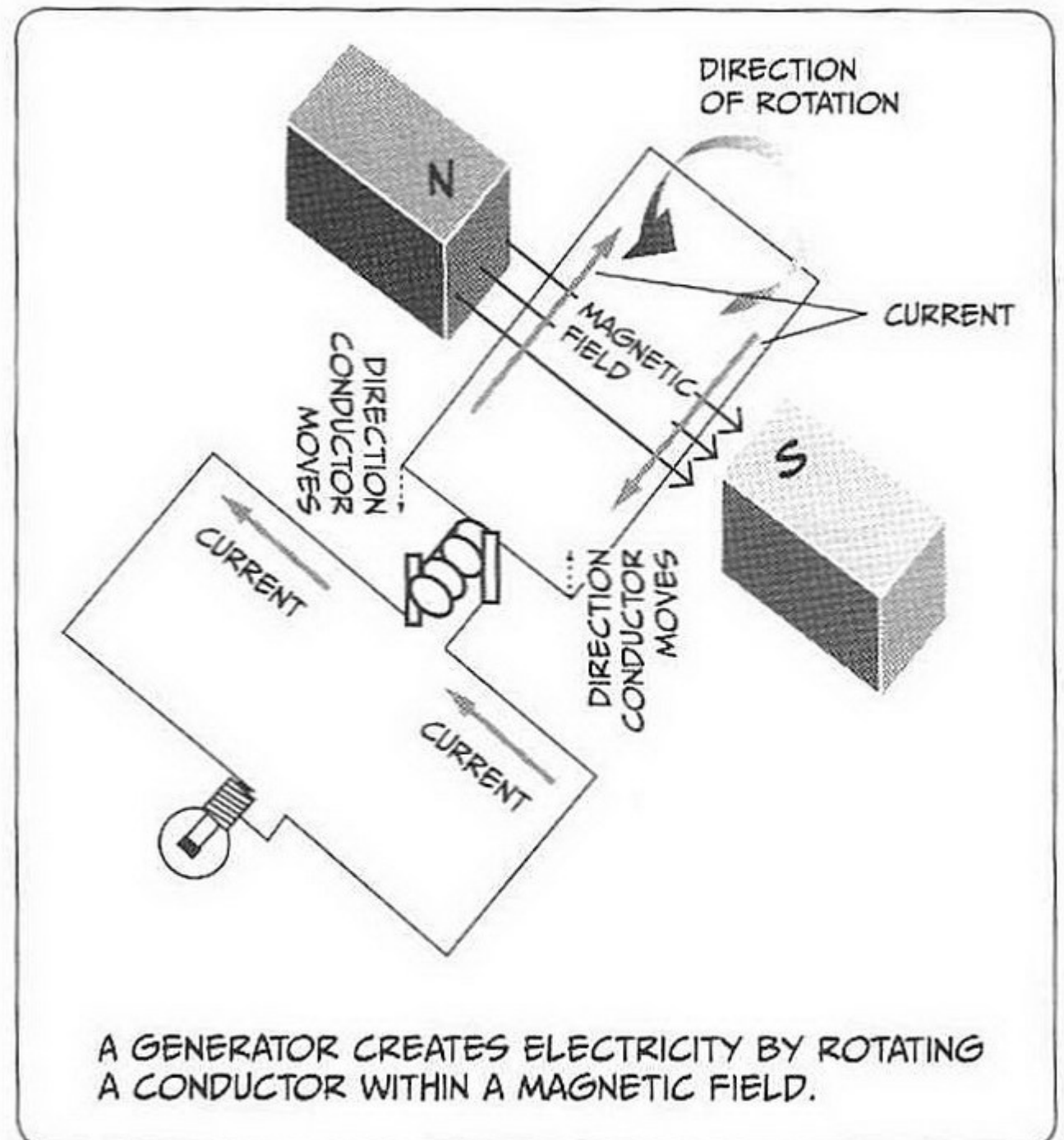

Electricity generated by a generator

You must apply a force to keep the loop spinning within the magnetic field. This could be the force from falling water, like in a hydroelectric generator, or the force of pressurized steam, like in a coal power plant.

But why do Fleming's hand laws work? We can better understand why generators and motors work by understanding how magnetism and electricity are related.

ELECTRICITY AND COILS

An electric wire wound in loops is called a *coil*. If current flows in a coil, a magnetic field is generated that goes through the inside of the coil. If an iron core is inserted in the coil, the magnetic field is concentrated in the iron, and it becomes a strong *electromagnet*. The strength of an electromagnet is proportional to the product of the current and the number of loops in the coil; if the direction of the current is reversed, the polarity of the electromagnet is also reversed. If the current is stopped, the magnetic force of the electromagnet disappears.

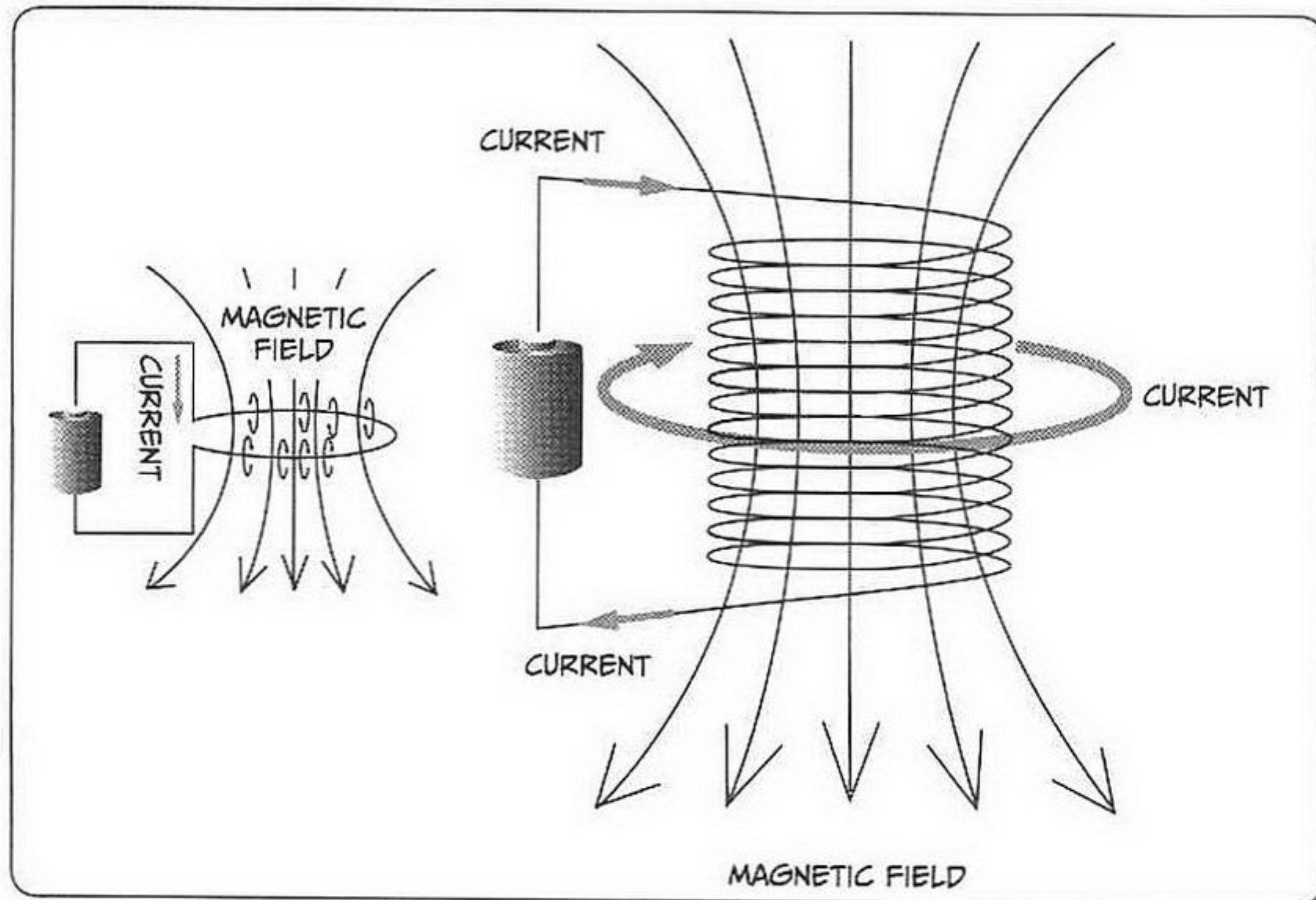

Magnetic field created by a coil of electric wire

You can use your right hand to find the orientation of the magnetic field induced by a coil. Just curl your fingers in the direction the current flows in the coil, and your thumb will point towards the N pole of the induced magnetic field.

COILS AND ELECTROMAGNETIC INDUCTION

When a bar magnet moves within a coil, current flows in that coil, which creates a magnetic field in order to oppose the change in magnetism. If the direction of the bar magnet's movement changes, the direction of the current in the wire also changes. This phenomenon is called *electromagnetic induction*, and the electricity that is generated during this process is called *induced electromotive force*. The current generated is called *induced current*.

Lenz's law, discovered by the Russian physicist Heinrich Friedrich Emil Lenz, states that the current due to electromagnetic induction flows in a direction such that the magnetic field produced by that current obstructs the motion of the magnet.

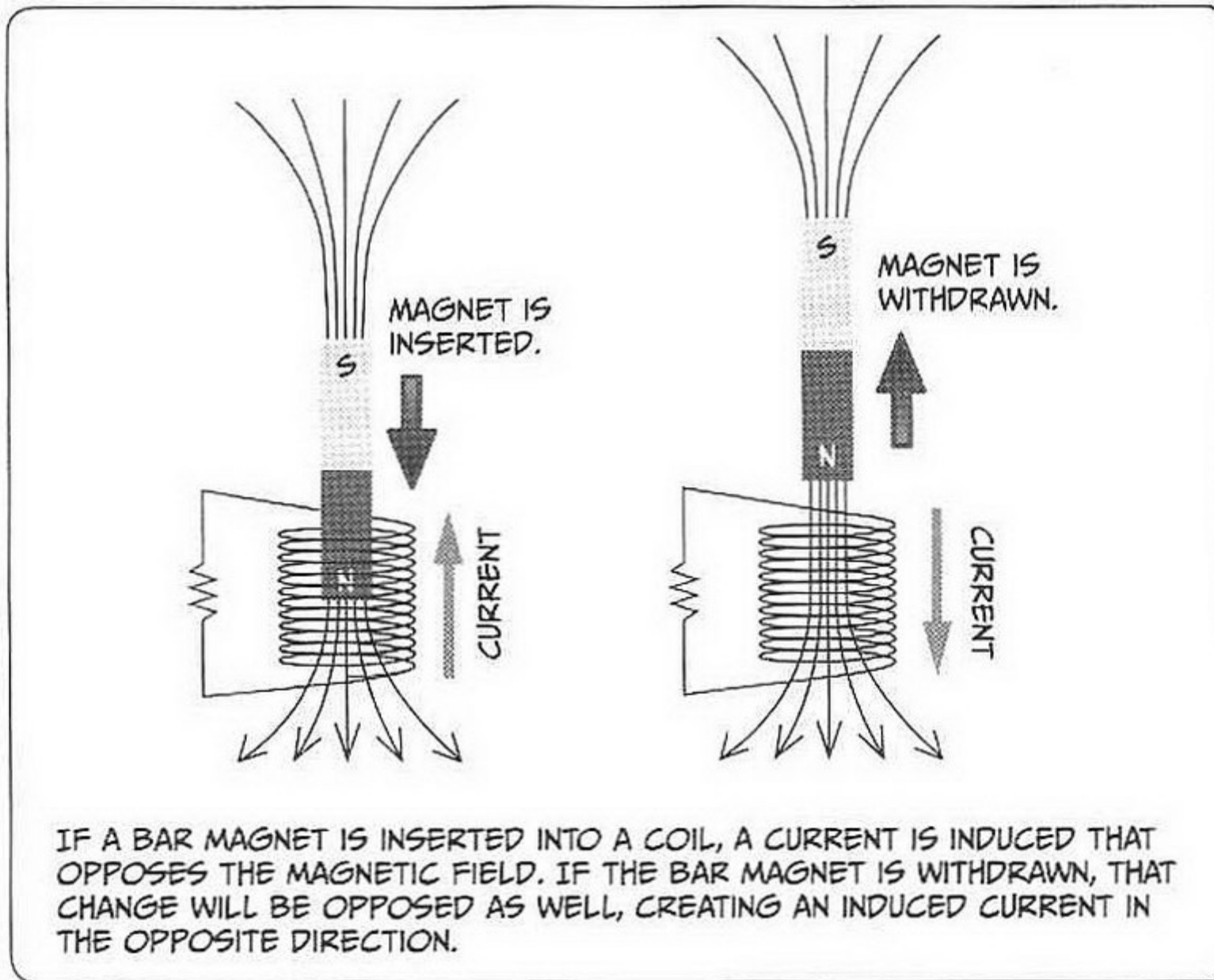

Electromagnetic induction

COILS AND INDUCTANCE

If a coil is connected to a battery and current begins flowing, the magnetic field generated becomes larger, and the coil becomes an electromagnet. At this time, an induced electromotive force is generated on the coil itself due to the varying magnetic fields. This is called *self-induction* or simply *inductance*.

When the current to the coil is cut off, the magnetic field begins to disappear, and an induced electromotive force is generated in the direction that obstructs the flow of current in the coil. This is called a *counter-electromotive force*. The counter-electromotive force can be easily verified. When a battery is connected to a coil and current flows, a magnetic field is generated. When the current is constant, no counter-electromotive force is generated, but when the battery is detached and the current is cut off, the magnetic field that was being generated becomes smaller. At this time, voltage due to the counter-electromotive force appears at both ends of the coil.

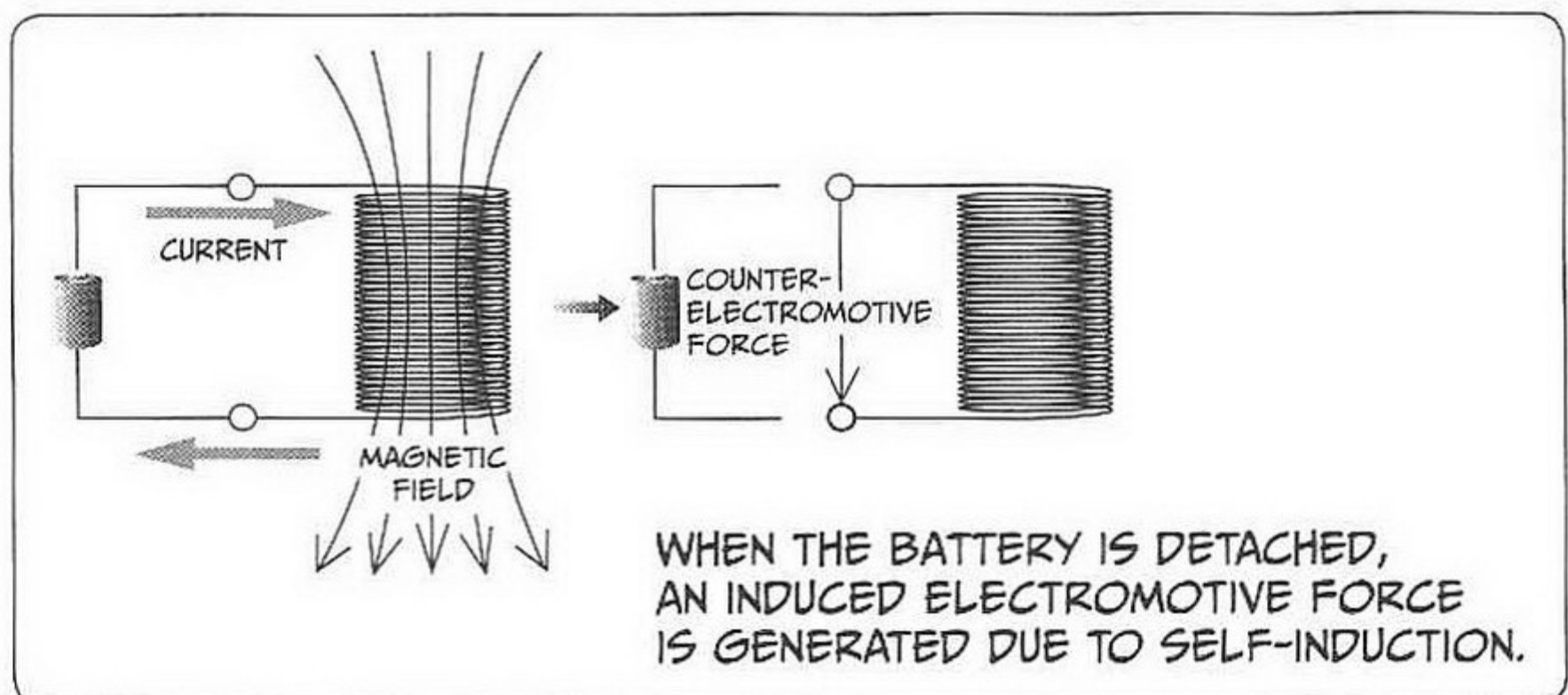

Self-induction of a coil

COILS AND ALTERNATING CURRENT

The magnitude of alternating current is always changing. If alternating current flows in a coil, an induced electromotive force is generated in the coil in the direction that obstructs the flow of the current, and current flows so that it lags behind the power supply voltage variation by one-fourth of a cycle. This is called the *lagging current*, and it flows in an electrical device such as a motor with a coil. This temporal lag is called a *phase difference*. The coil acts like a resistance to the current as described above. This is called *inductive reactance*, and its magnitude is proportional to the frequency of the alternating current.

Electric power consumption is represented by the product of voltage and current, and when the voltage and current waves match with respect to time, 100 percent work is done—in other words, “the power factor is 100 percent.” If the current lags, the power factor will be less than 100 percent, and the circuit is said to have a “low power factor.”

If the power factor is low, the electric power that is input from the power supply will not do 100 percent work, so a power supply having a correspondingly larger capacity is required. The ratio of the consumed power to the input power is the *power factor*.

$$\text{Power factor} = \frac{\text{Consumed power}}{\text{Input power}}$$

A low power factor means that some current returns to the power supply without doing work.

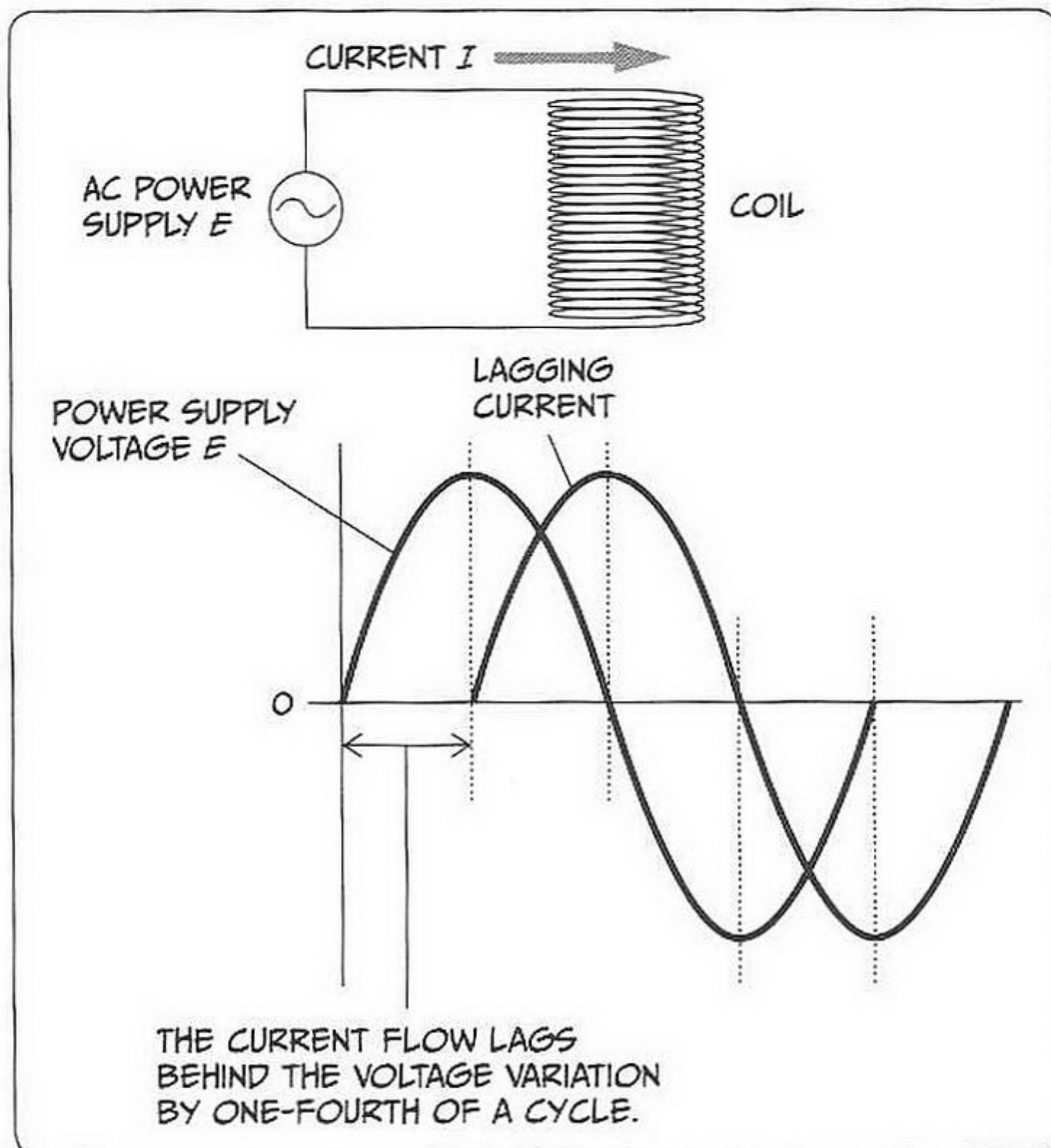

Lagging current flowing in a coil

COILS AND TRANSFORMERS

If an AC power supply is connected to coil 1, a magnetic field is generated. When this magnetic field varies within coil 2, an induced electromotive force is generated in coil 2. This phenomenon is called *mutual induction*. A *transformer* is an electrical device that uses this phenomenon to change voltage.

If two coils are wrapped around an iron core, and an AC power supply is connected to coil 1, a magnetic field is generated and passes through the inside of the iron core. Since coil 2 has been wrapped around the same iron core, the magnetic field varies inside coil 2, and an induced electromotive force is generated in coil 2.

The power supply side of a transformer is called the *primary side*, and the load side is called the *secondary side*. The voltage generated on the secondary side is determined by the ratio of the number of turns (n_1) of the primary coil and the number of turns (n_2) of the secondary coil. For example, if the number of turns of the secondary coil is twice that of the primary coil, twice the voltage is generated on the secondary side. The current that flows

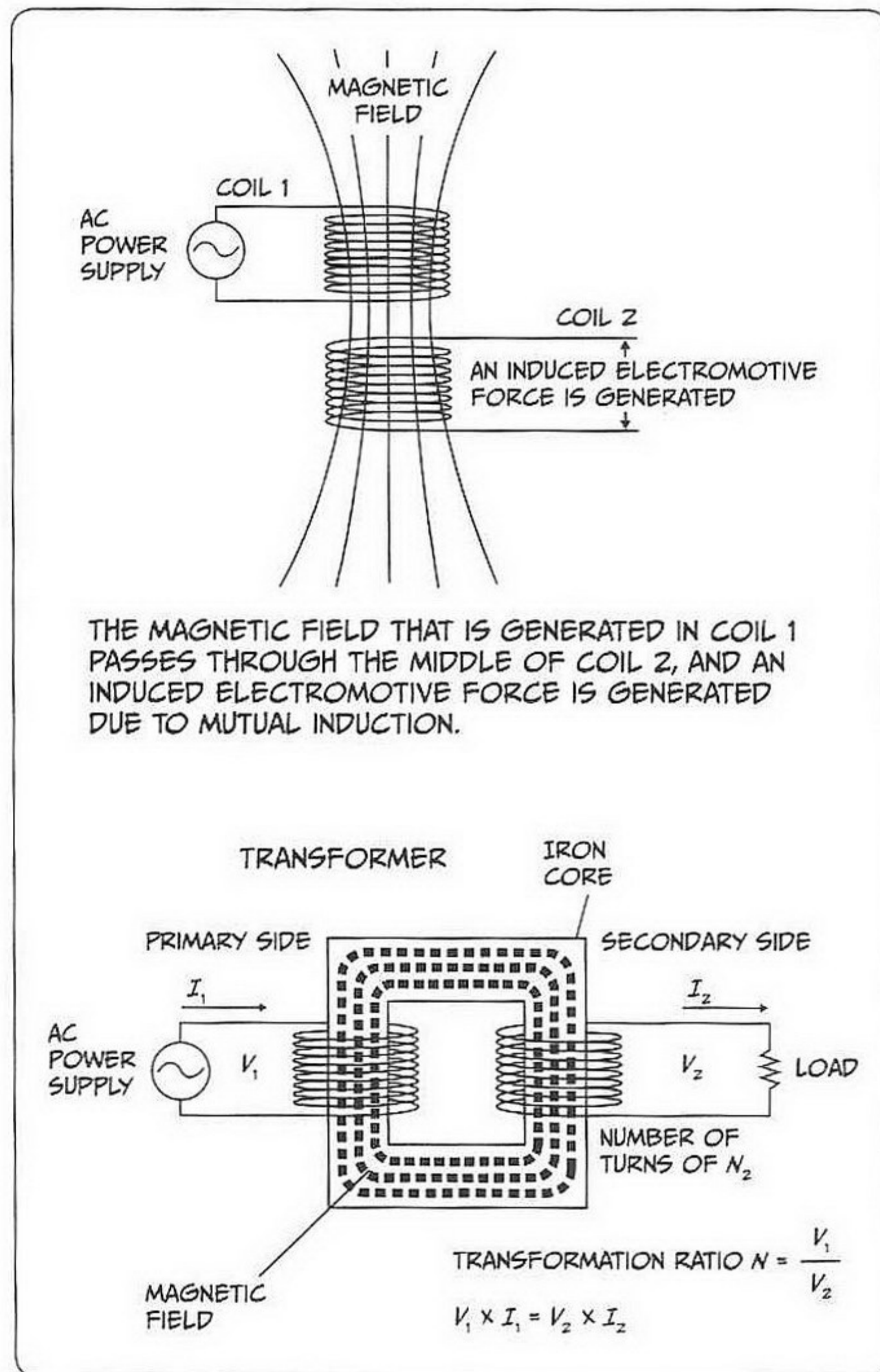

Mutual induction in a transformer

in the secondary coil at this time will be half the current that flows in the primary coil. The equation that describes this relationship is:

$$V_1 I_1 = V_2 I_2$$

The ratio of the primary voltage (V_1) and secondary voltage (V_2) is called the *transformation ratio*, and the product of the primary voltage and the current will be equal to the product of the secondary voltage and the current. In other words, a transformer only changes voltage—it does not change the magnitude of the electric power.

CAPACITORS

When an insulator is sandwiched between two metal plates and a battery is connected, electrons move from the negative pole of the battery to the bottom metal plate to charge it. Since the electrons in the top metal plate move to the positive pole of the battery, the top metal plate is positively charged. At this time, charge is stored on the metal plates. An object that stores charge in this way is called a *capacitor*.

Current flows from the instant the battery is connected, but eventually the electrons will stop moving, as charge builds on the capacitor. In other words, if a DC power supply is connected to a capacitor, current flows only at first and then stops because of the gap in the circuit. If the battery is detached in this state, the charge remains stored on the capacitor. If the battery is then connected in the reverse direction, the charge that had been stored discharges, and the capacitor is charged in the opposite direction.

The ability of the capacitor to store charge in this way is called *capacitance*; its magnitude is directly proportional to the area of the metal plate and inversely proportional to the distance between the metal plates. Capacitance is measured in *farads (F)*.

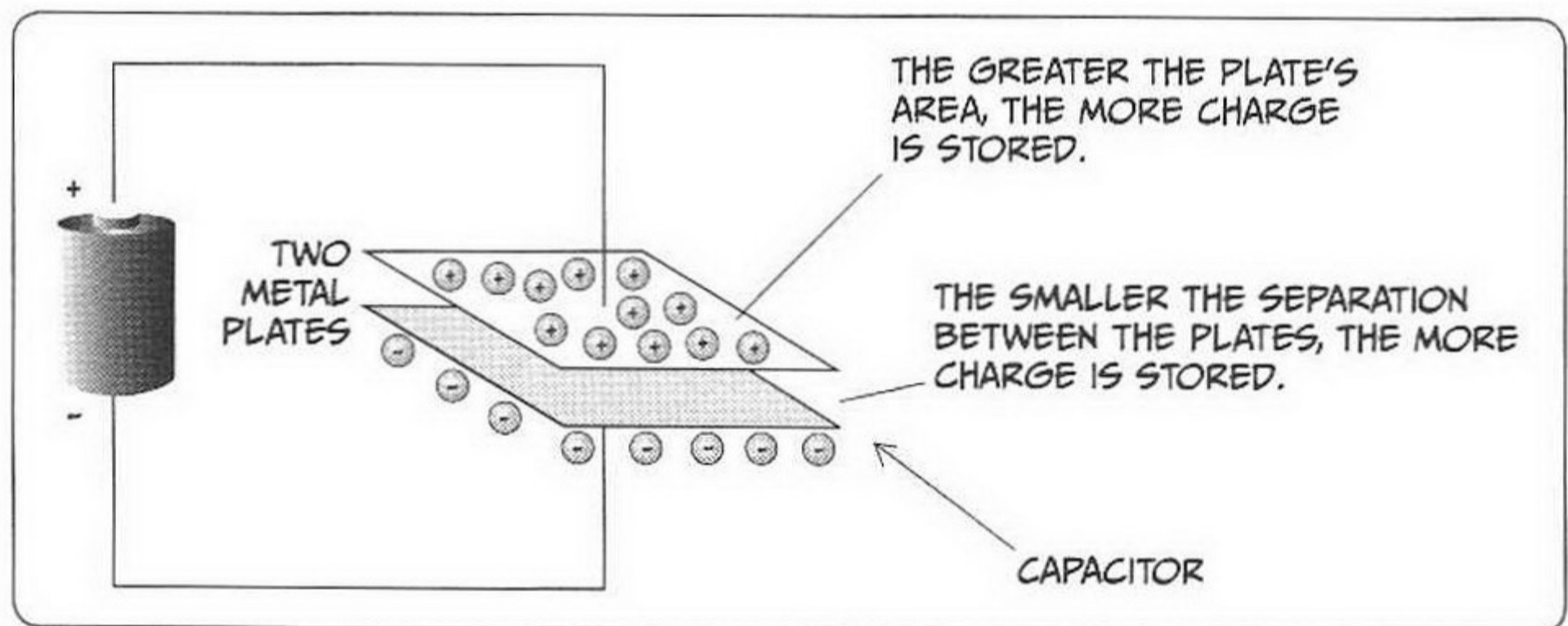

Charge stored on a capacitor

CAPACITORS AND ALTERNATING CURRENT

If AC voltage is applied to a capacitor, a charged current flows until the power supply voltage reaches its maximum (starting from 0V). The current is zero at the power supply's peak voltage. When the power supply voltage decreases from its peak voltage, discharging begins, and the discharge current reaches its maximum when the power supply voltage is 0V.

At this time, the polarity of the power supply voltage changes, and a current flows again. Charging stops when the power supply voltage reaches its peak voltage for the opposite polarity, and then discharging occurs again.

If a capacitor is connected to an AC power supply, the variation of the current is one-fourth of a cycle ahead of the variation of the power supply voltage; this current is called *leading current*.

A capacitor works like resistance to alternating current. This is called *capacitive reactance*, and its magnitude is inversely proportional to the frequency.

If an AC circuit has a coil, the current lags, and the power factor decreases. If a capacitor is connected to that circuit, the current leads, and the power factor increases.

In an AC circuit, capacitors and coils act like resistance, and are called *impedance*.

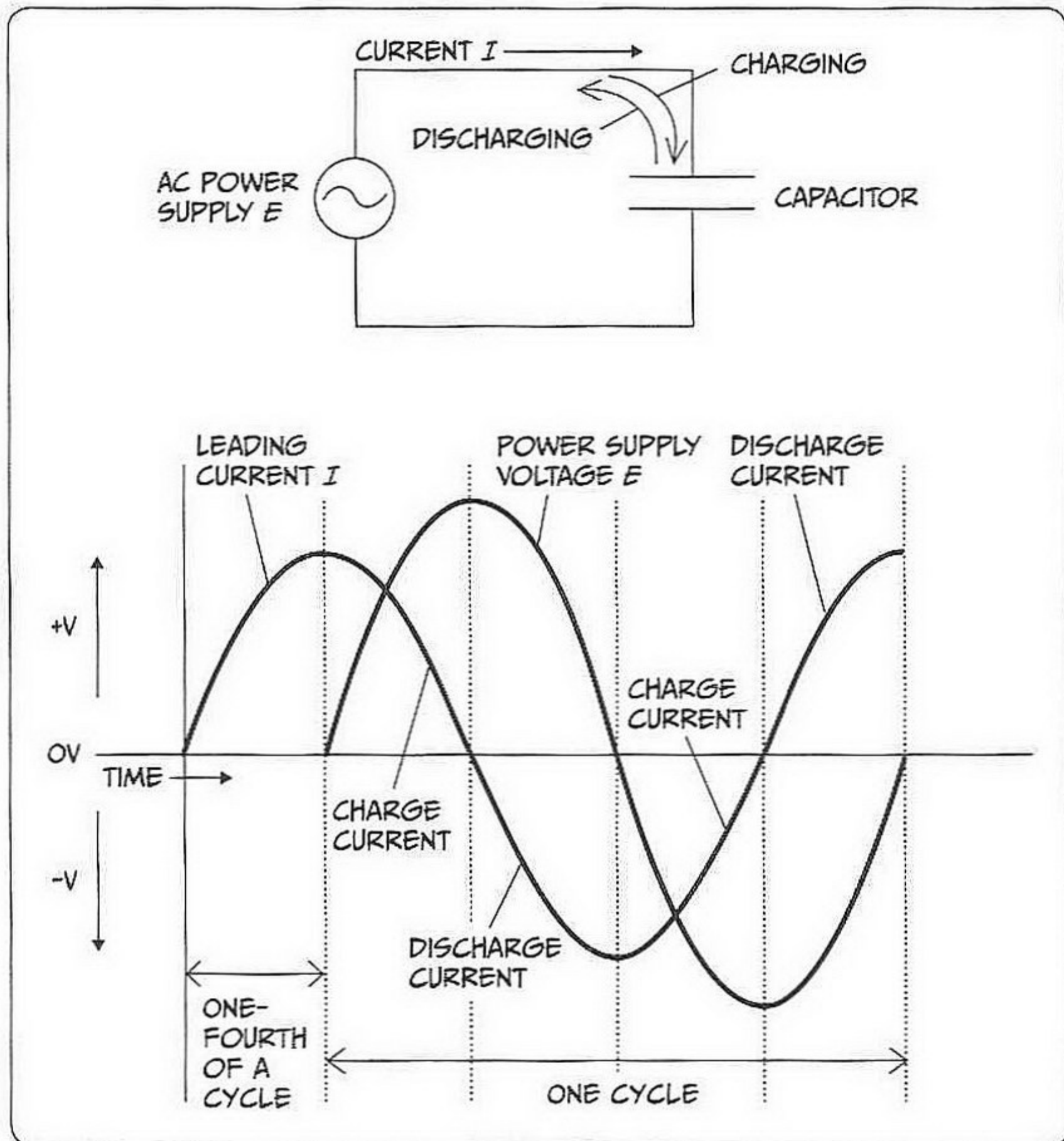

Leading current flowing in a capacitor



4

HOW DO YOU CREATE ELECTRICITY?



GENERATORS

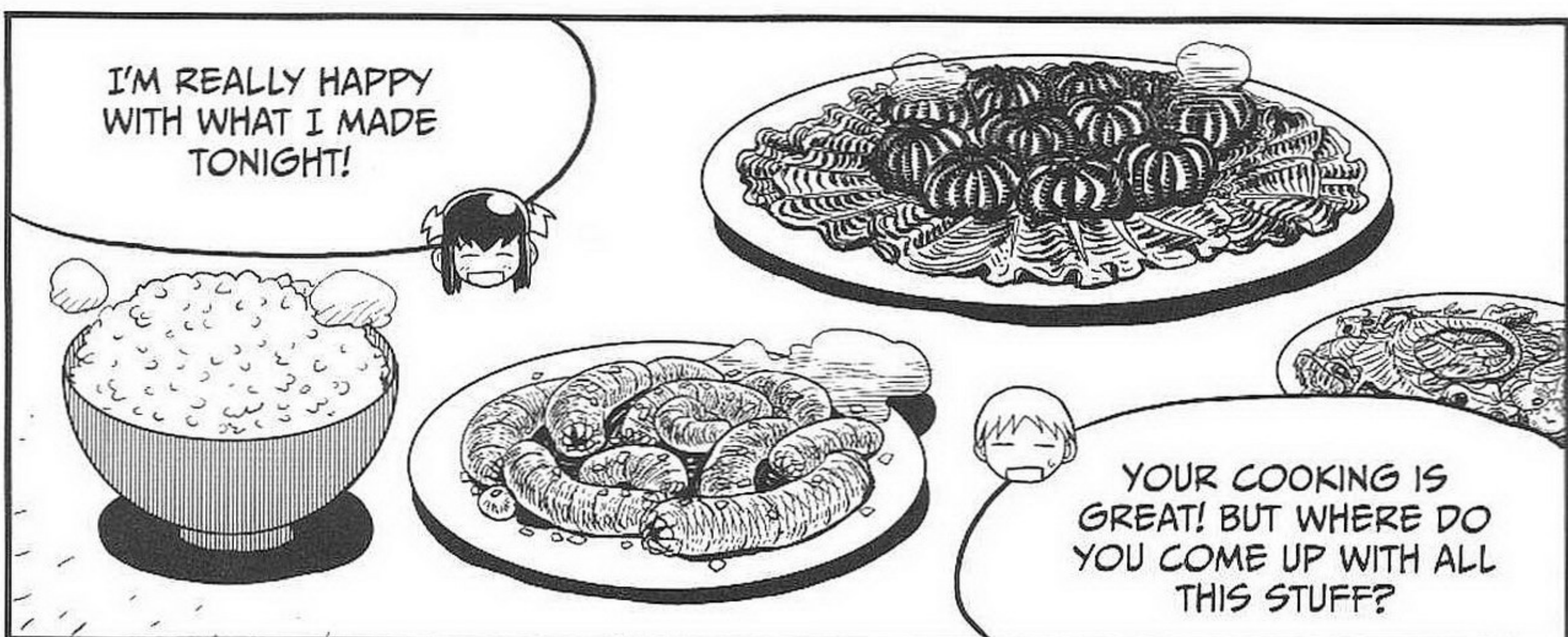



WELL, IT ISN'T TERRIBLE...

...YOU KNOW, SOMETIMES...



...WE SEEM JUST LIKE A MARRIED COUPLE, DON'T WE?



WHAAAT!!!?

HEE HEE!
I'M JUST JOKING!

NO, IT'S PLAIN TO SEE!
YOU ARE A FREELOADER!



I'M APPALLED BY WHAT YOU ARE SUGGESTING...

SCARF
SCARF

...A MARRIED COUPLE...

OM NOM NOM



WHEN WE FINISH EATING, WE'LL START OUR LESSONS, OKAY?

OKAY, FINE.

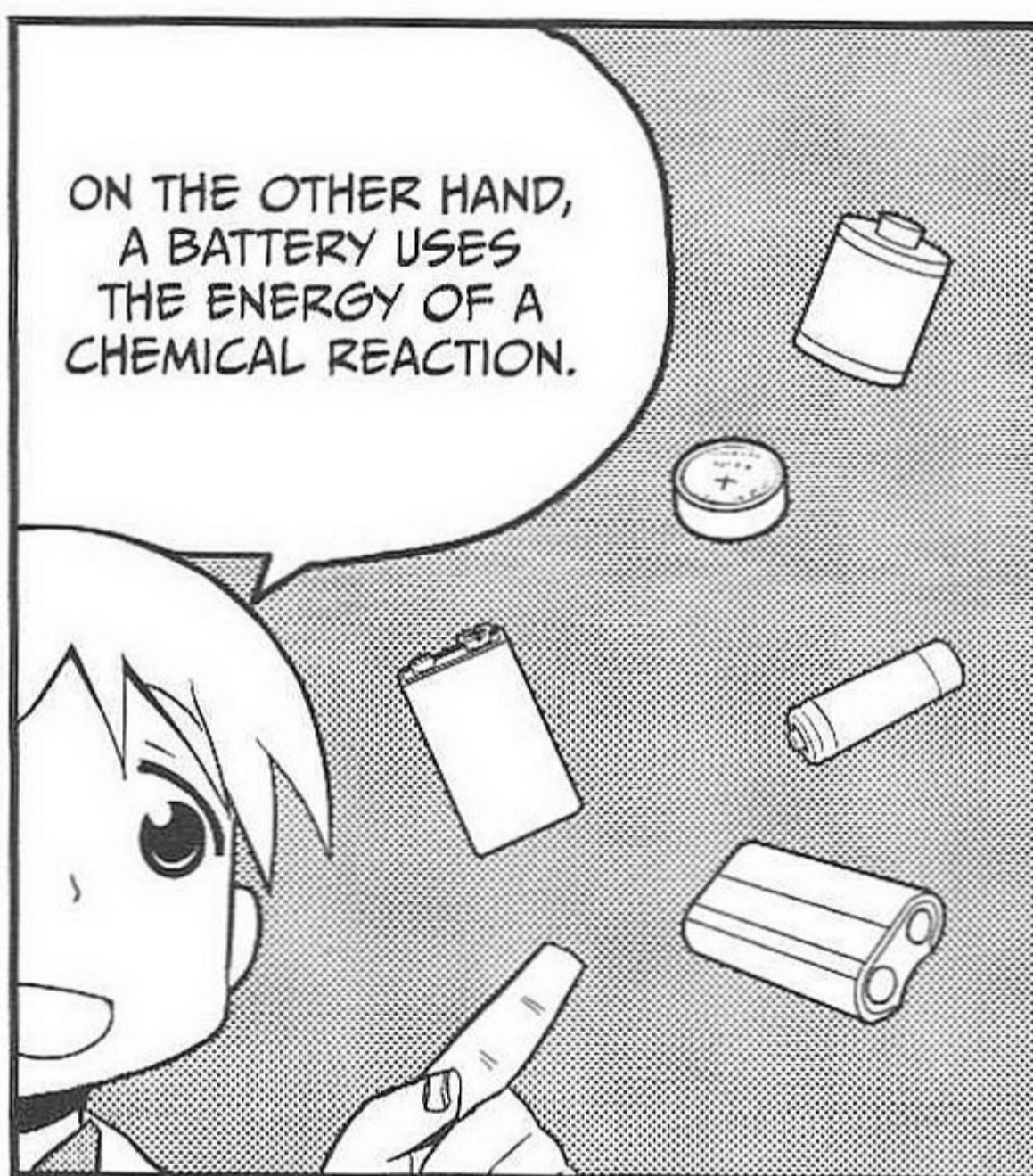
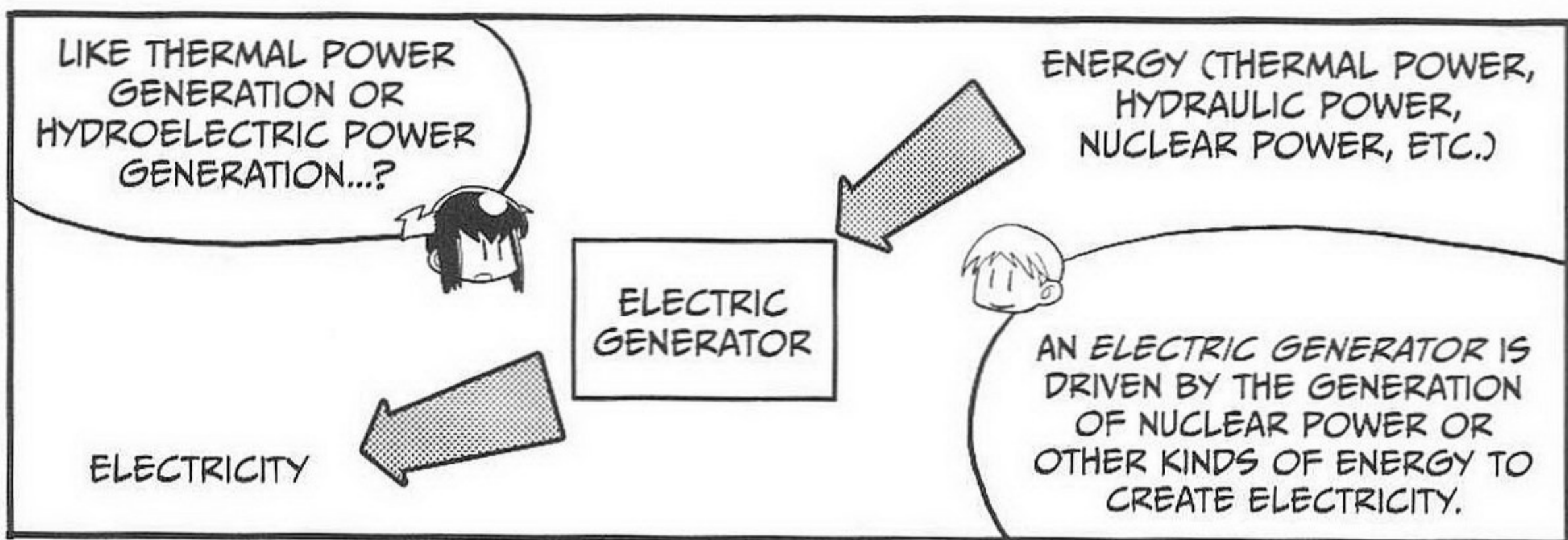
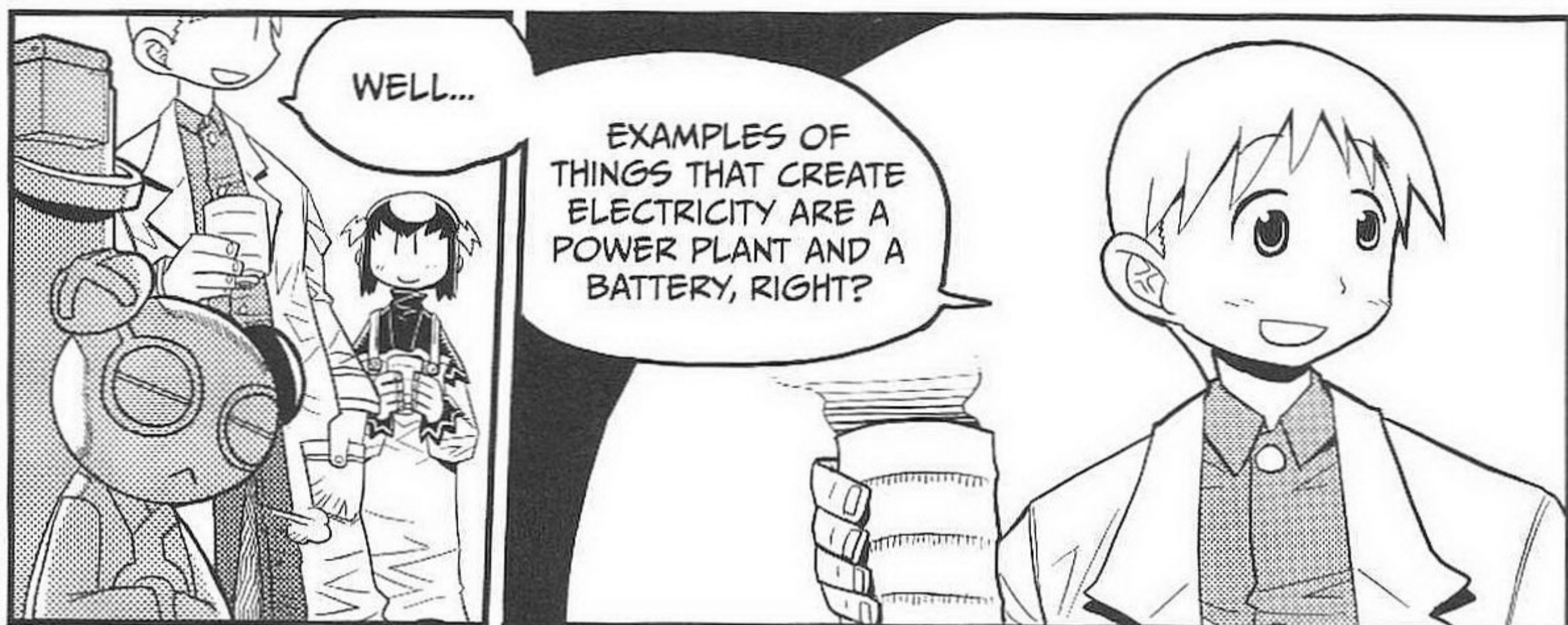

HOW DOES A POWER GENERATOR CREATE ELECTRICITY?

FIRST, LET'S TALK ABOUT ELECTRICITY CREATED BY AN ELECTRIC GENERATOR. THE OTHER DAY, WE TALKED ABOUT ELECTRICITY BEING CREATED ACCORDING TO FLEMING'S RIGHT-HAND RULE.

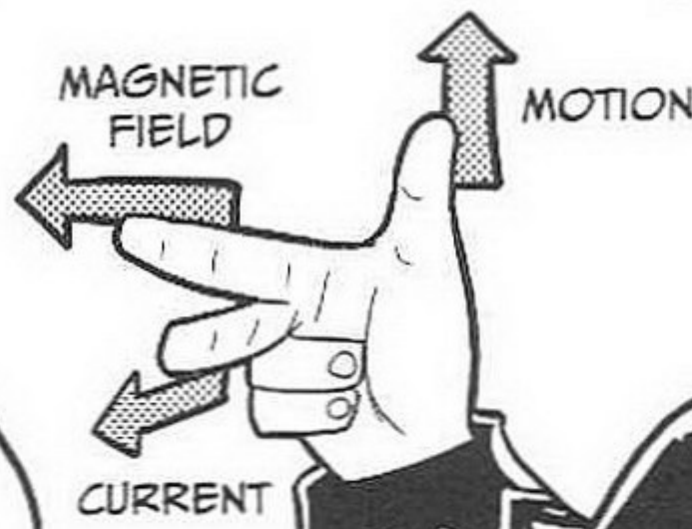

YEAH! IT'S THIS, RIGHT?

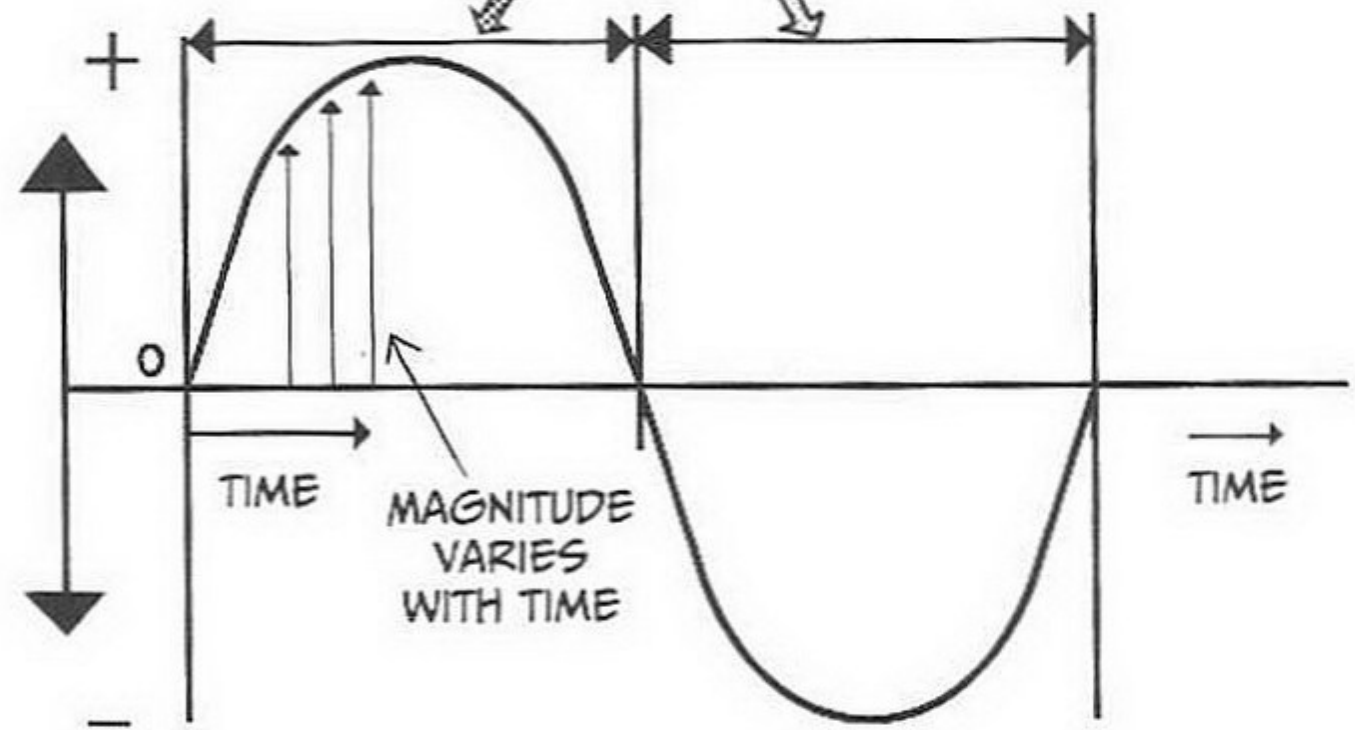
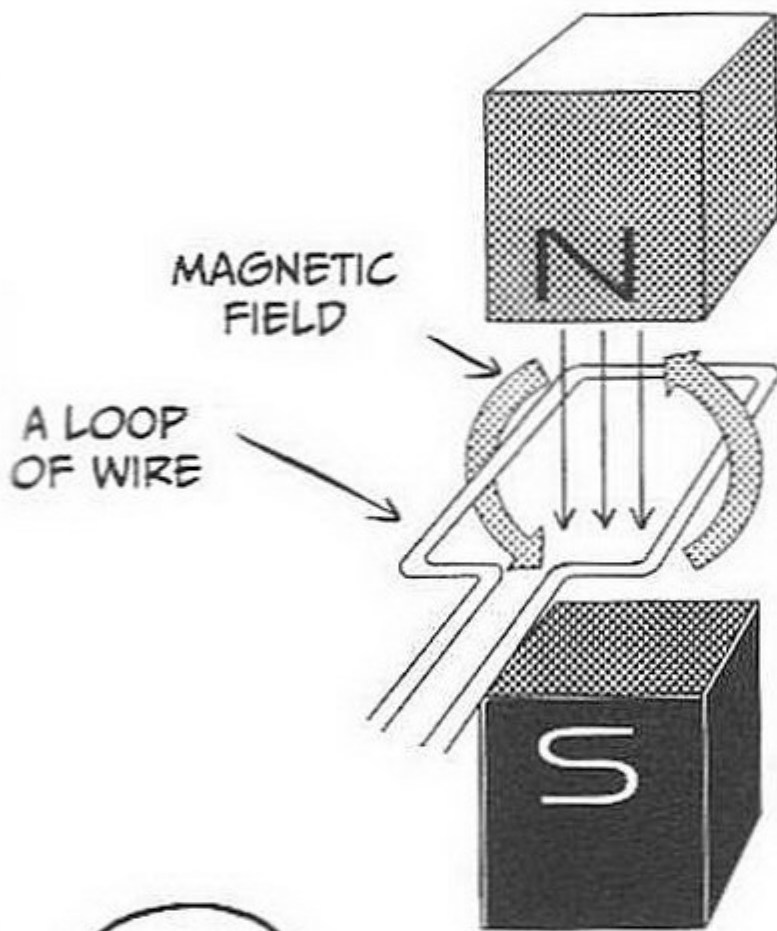
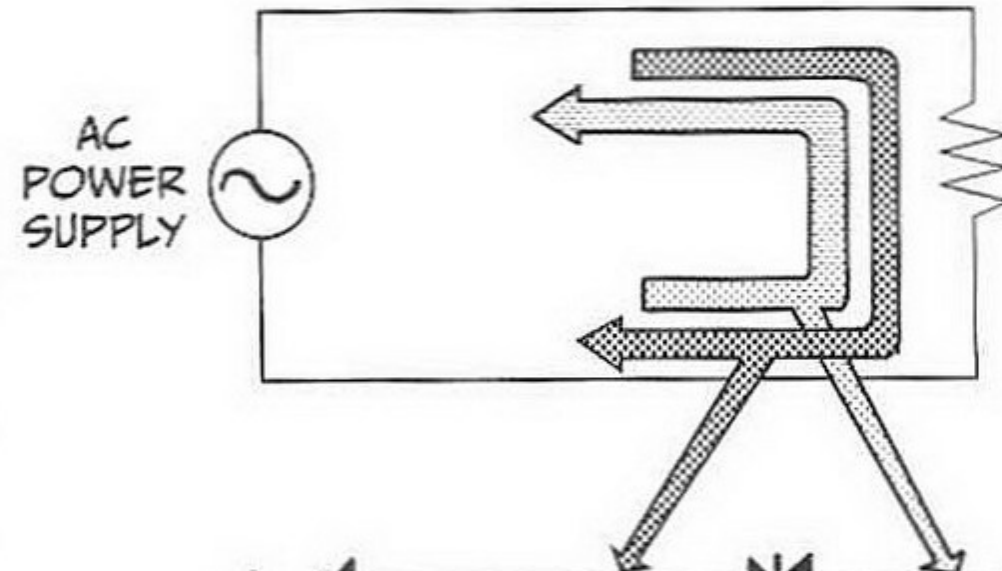

YES, BUT ACTUALLY, SINCE THE LOOP OF WIRE IS ROTATING WITHIN THE MAGNETIC FIELD, ELECTRICITY IS CREATED FOR WHICH BOTH THE MAGNITUDE AND DIRECTION OF FLOW VARY REPEATEDLY LIKE A WAVE.

THIS IS AC ELECTRICITY, RIGHT?



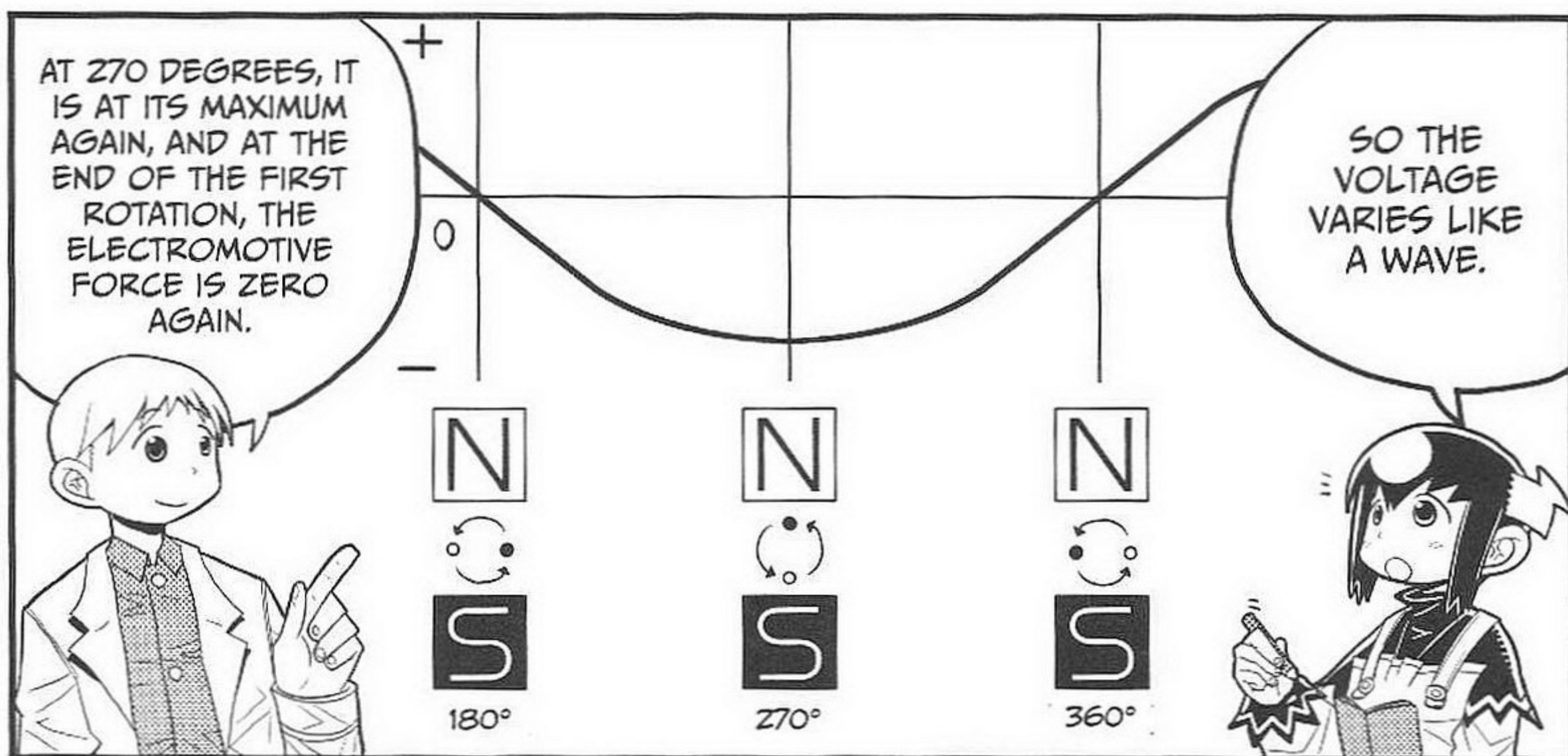
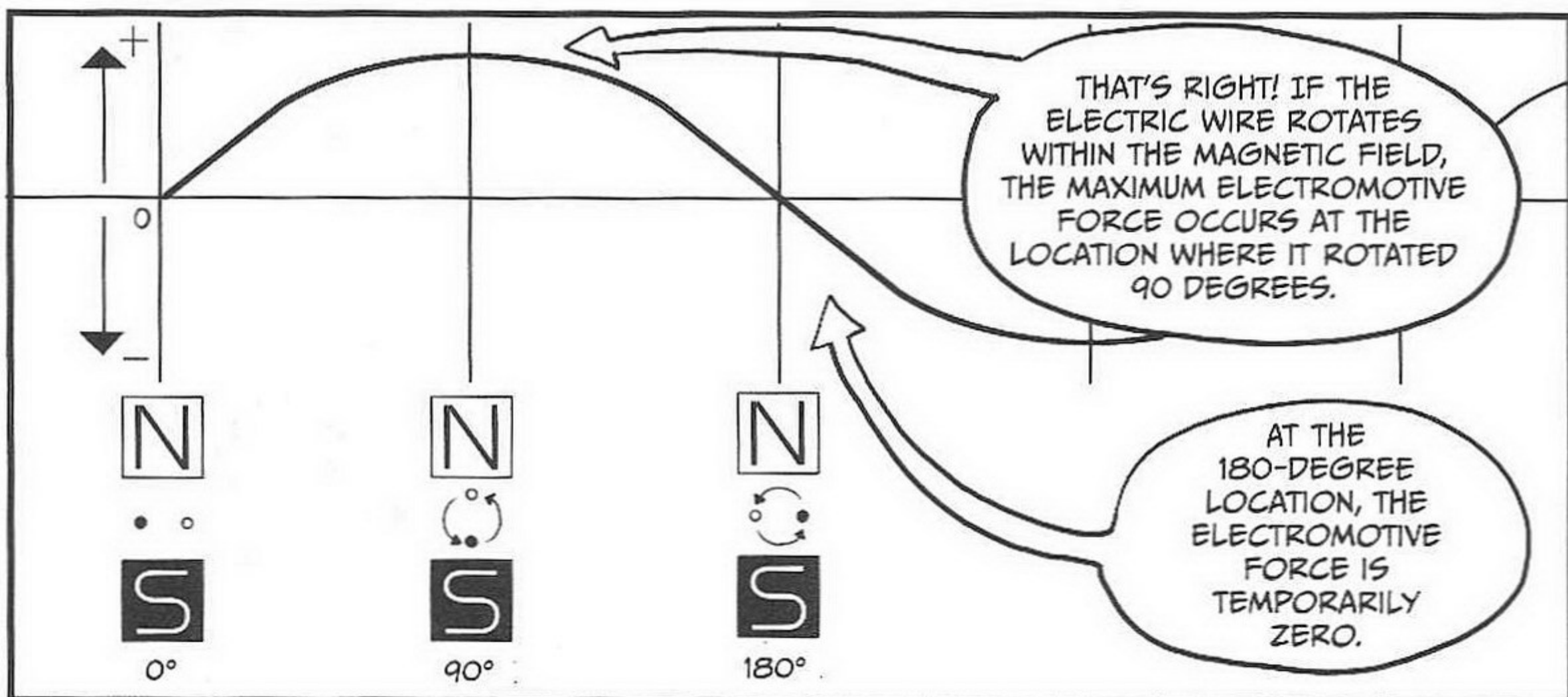

THE VOLTAGE OF AN ORDINARY HOUSEHOLD ELECTRIC OUTLET IS 120V AC.

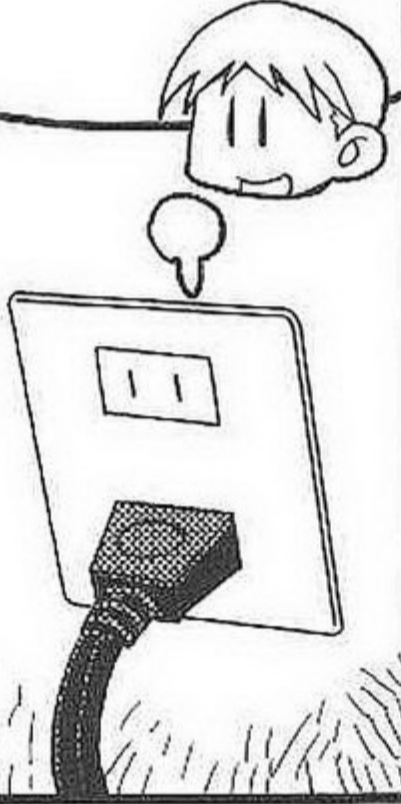

THIS VALUE IS CALLED THE EFFECTIVE VOLTAGE. IT IS THE VOLTAGE VALUE FOR WHICH THE AMOUNT OF HEAT THAT OCCURS WHEN AN AC POWER SUPPLY IS APPLIED TO A RESISTANCE IS THE SAME AS THE AMOUNT OF HEAT THAT OCCURS WHEN A DC POWER SUPPLY IS APPLIED TO THE SAME RESISTANCE.



DIRECT CURRENT (DC)
120V

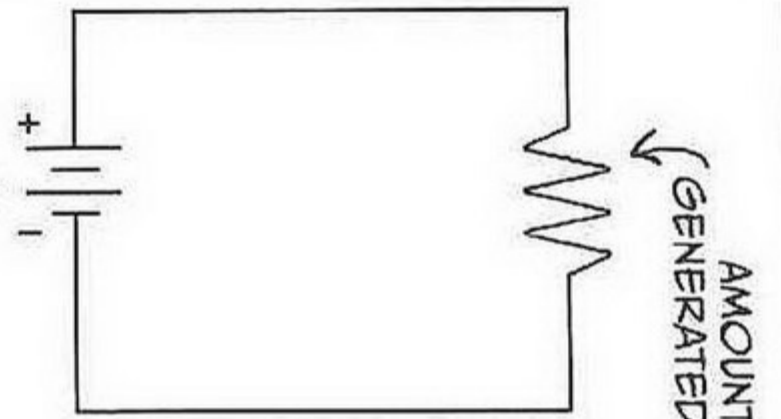

ALTERNATING CURRENT (AC)
120V

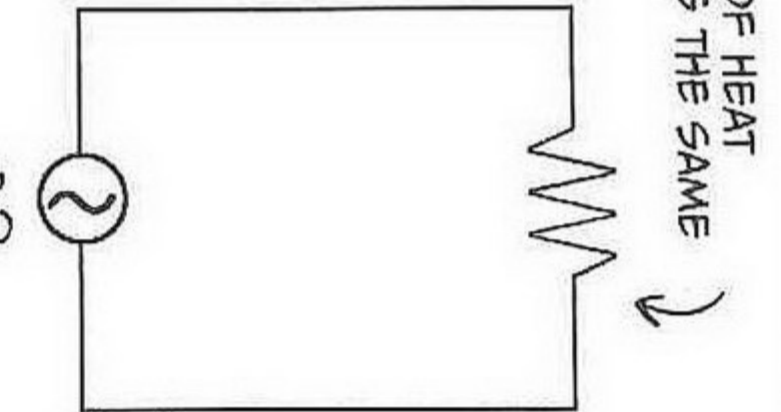

HUH?

SO YOU'RE SAYING THAT WHEN 120V DC AND 120V AC ARE EACH APPLIED TO THE SAME RESISTANCE, THE SAME HEAT IS PRODUCED.



YEAH, BUT ALTERNATING CURRENT HAS A WAVE...

PEAK VOLTAGE 170V
EFFECTIVE VOLTAGE 120V

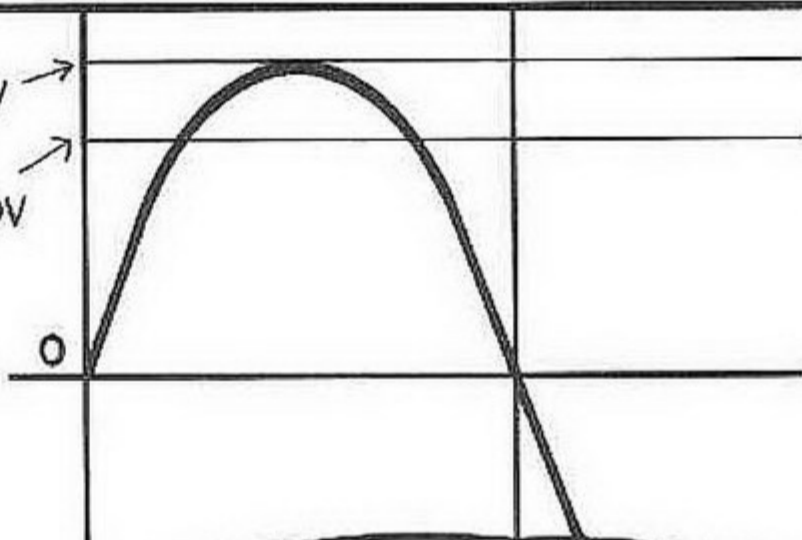

ALTHOUGH THE VOLTAGE (EFFECTIVE VOLTAGE) OF THE ELECTRIC OUTLET IS 120V AC, THE VOLTAGE AT THE POINT WHERE THE WAVE HAS THE GREATEST MAGNITUDE IS CALLED THE PEAK VOLTAGE, AND THIS IS APPROXIMATELY 170V.



BATTERIES AND OTHER SOURCES OF ELECTRICITY

LET'S TALK ABOUT HOW TO CREATE ELECTRICITY.

BATTERIES ARE JUST ONE SOURCE OF ELECTRICITY. A MORE GENERAL TERM FOR THESE DEVICES IS VOLTAIC CELLS.

YEP, I KNOW THAT.

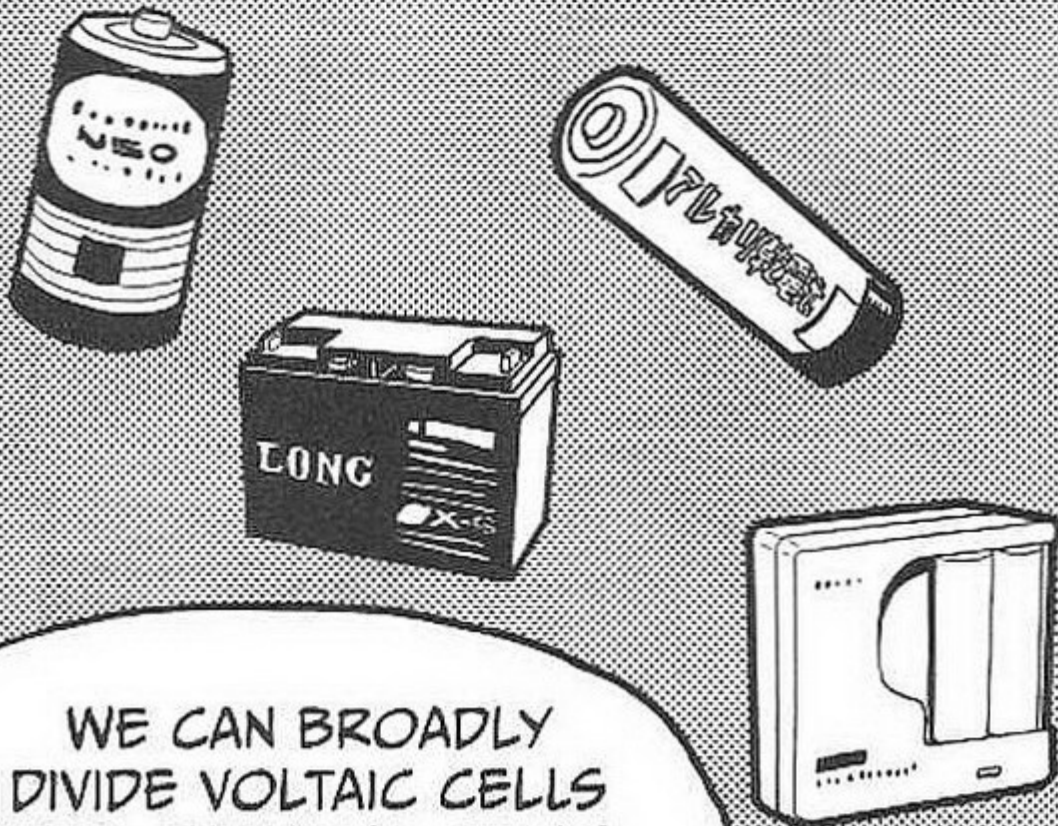

WE CAN BROADLY DIVIDE VOLTAIC CELLS INTO CHEMICAL CELLS, WHICH USE A CHEMICAL REACTION, AND...

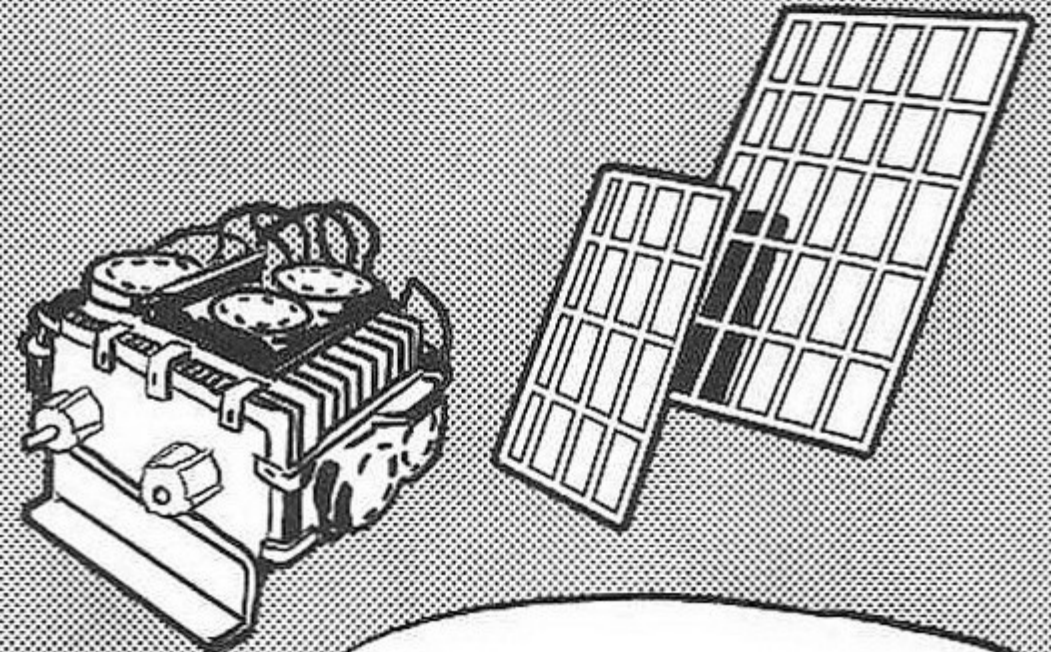

PHYSICAL CELLS, WHICH USE SOLAR OR THERMAL ENERGY.

SO THERE ARE TWO MAIN TYPES.

PHYSICAL CELL

CHEMICAL CELL

PRIMARY CELL

SECONDARY CELL

FUEL CELL

CHEMICAL CELLS CAN FURTHER BE DIVIDED INTO PRIMARY CELLS, WHICH CANNOT BE RECHARGED, SECONDARY CELLS, WHICH CAN BE RECHARGED AND REPEATEDLY USED, AND FUEL CELLS.

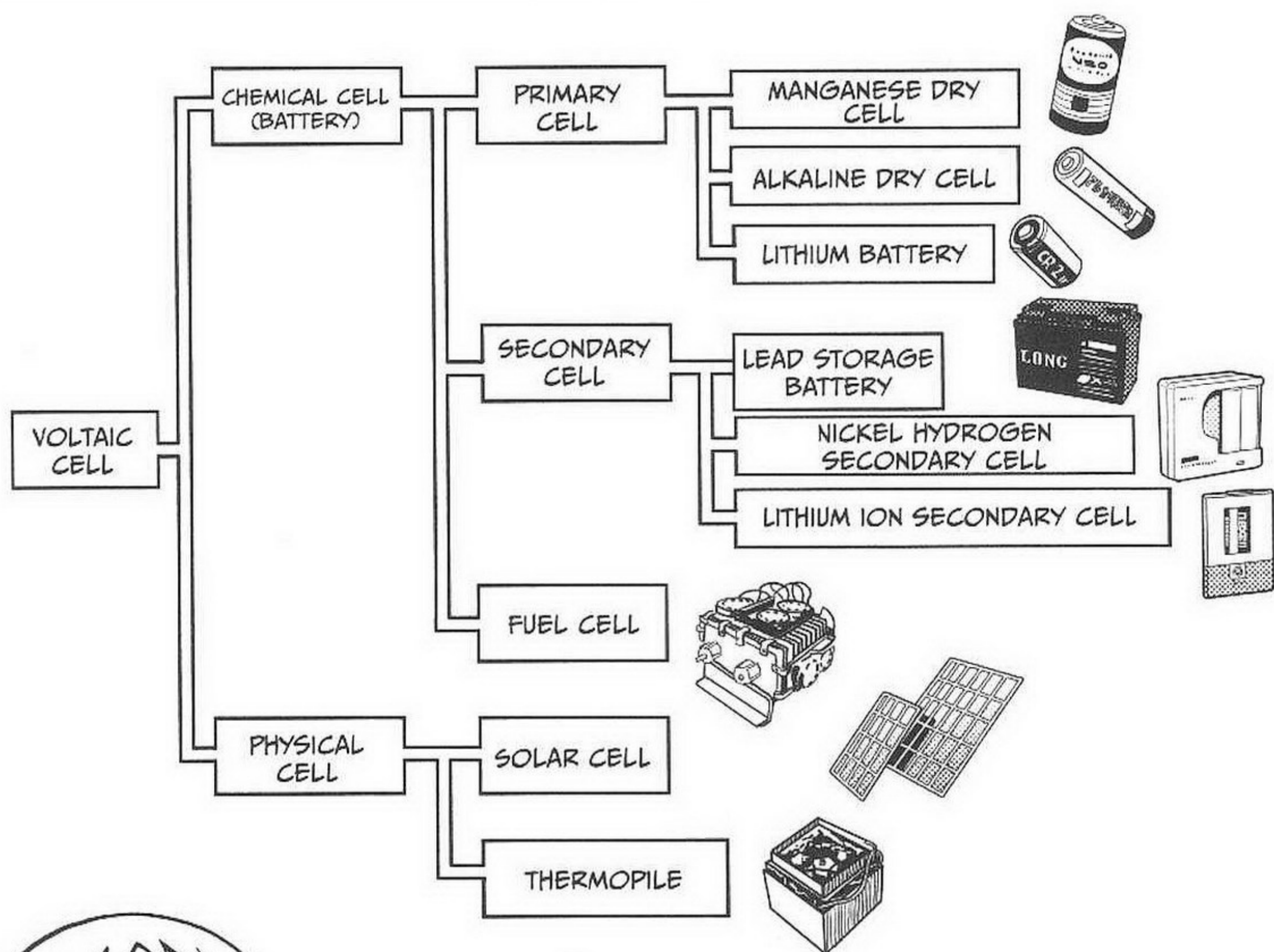
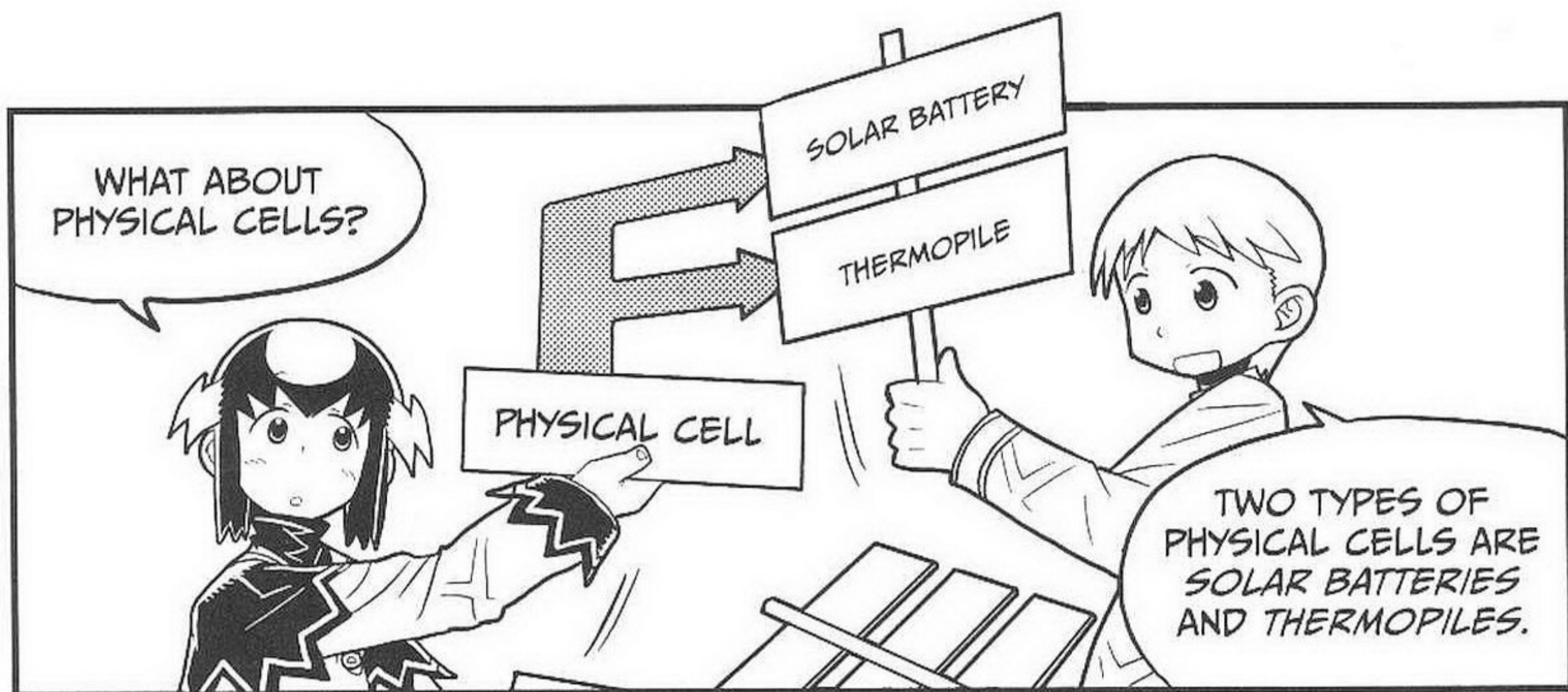

CHEMICAL CELLS

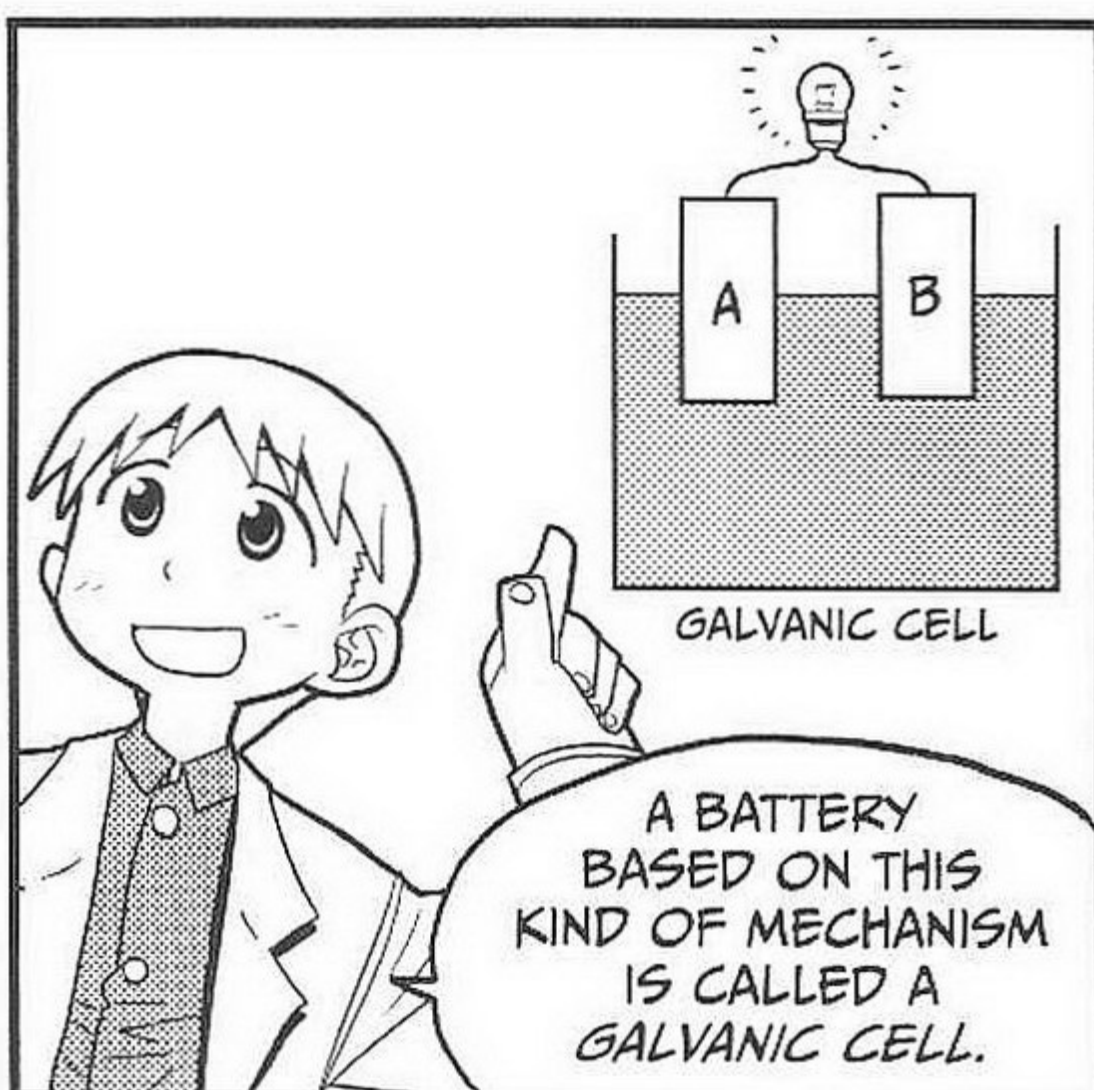
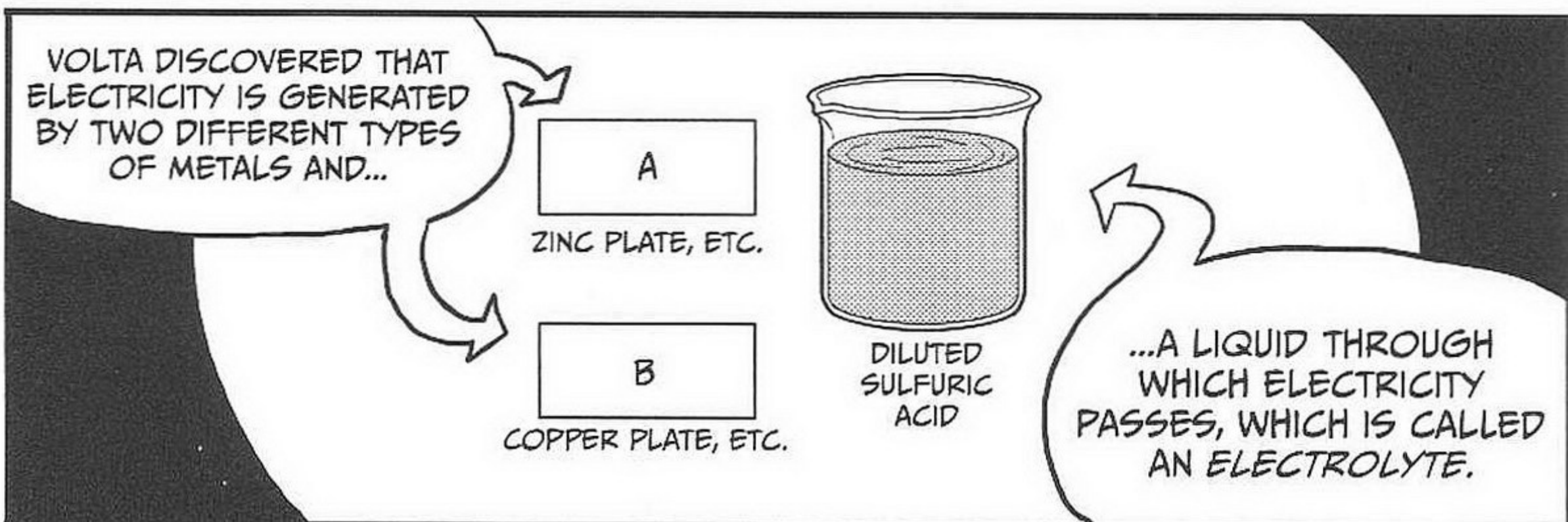
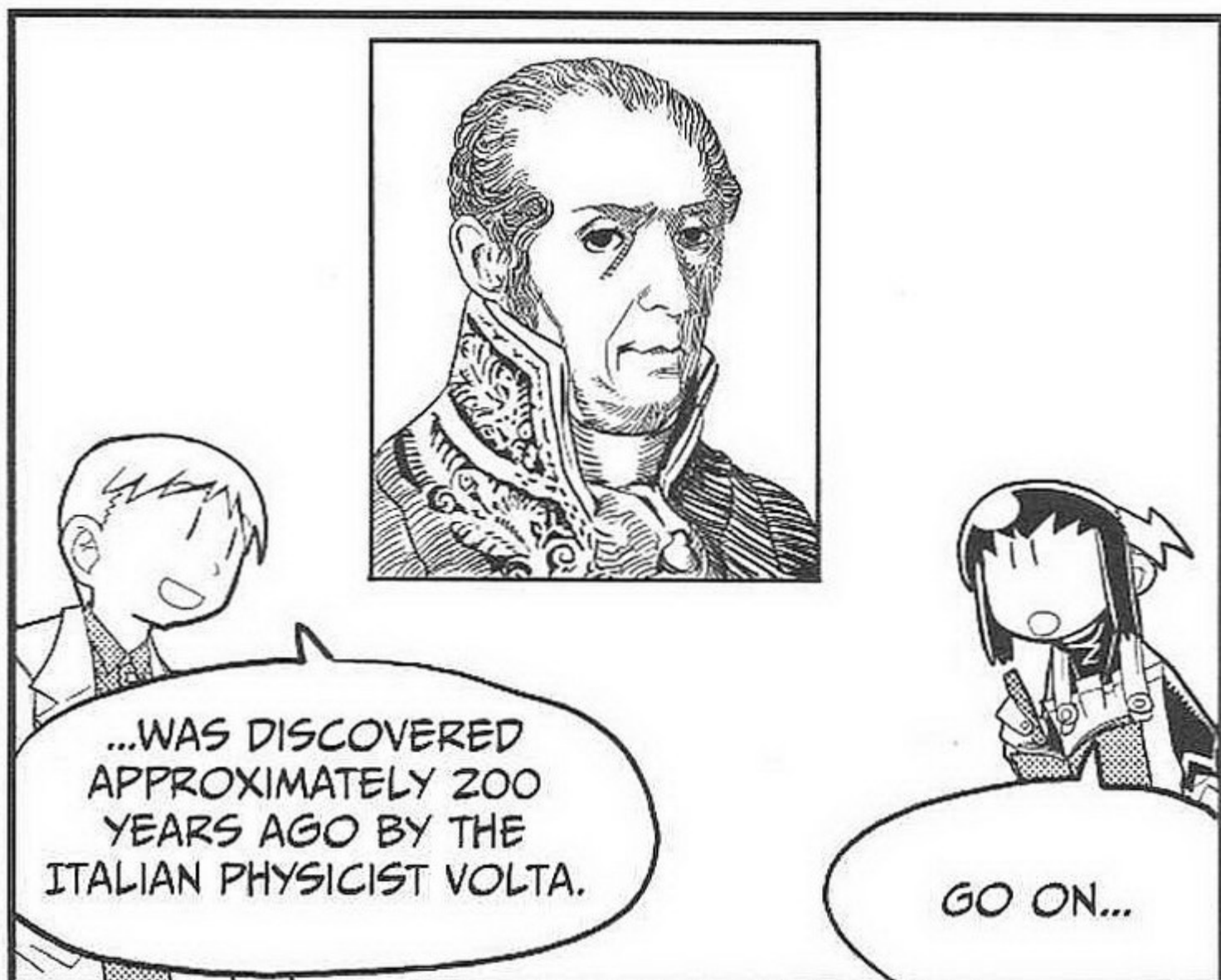

LET'S ASSUME THAT A ZINC PLATE AND A COPPER PLATE, WHICH ARE IMMERSED IN DILUTED SULFURIC ACID, ARE CONNECTED BY A CONDUCTOR. THESE TWO PLATES ARE CALLED **ELECTRODES**.

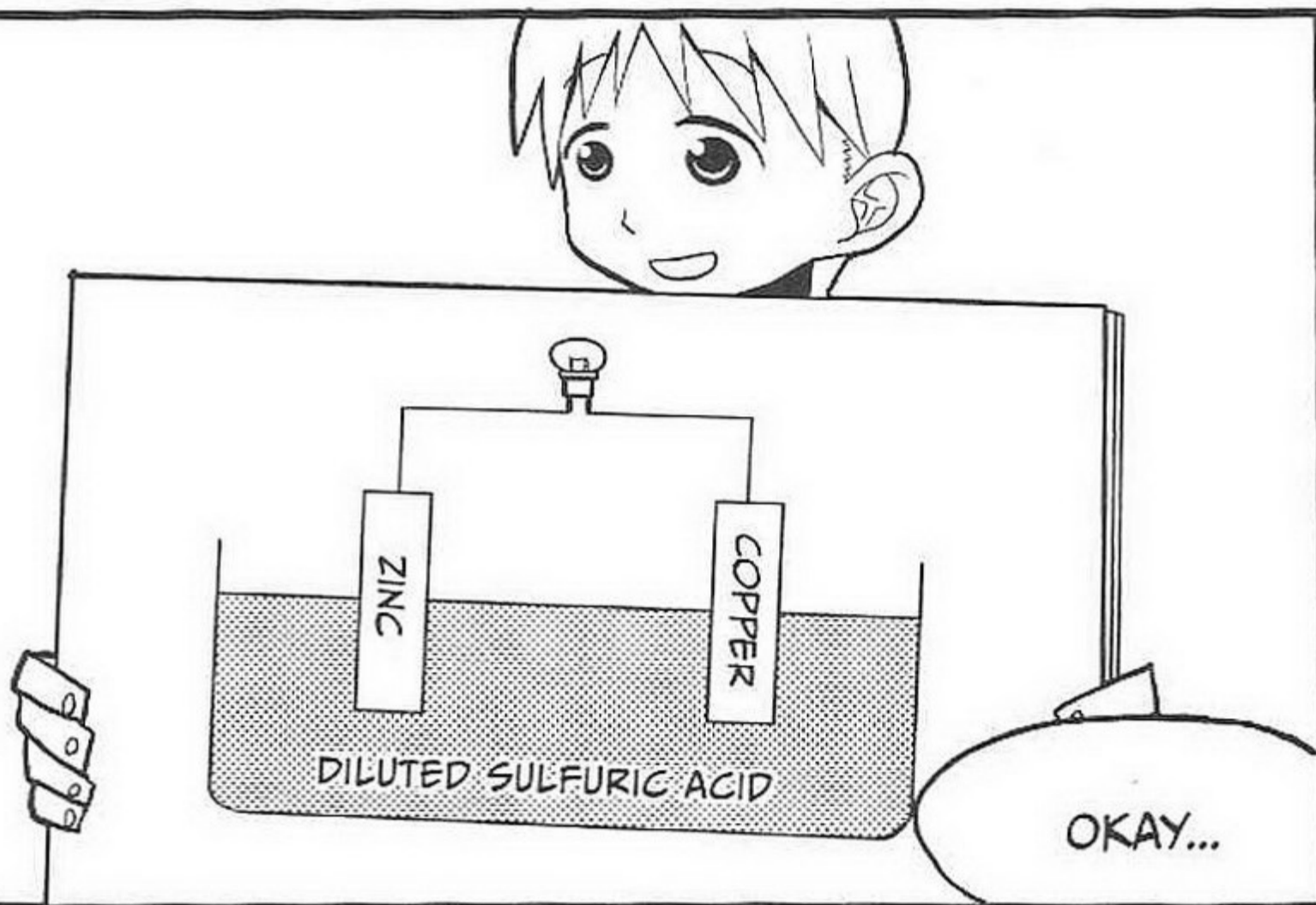

SINCE ZINC IONIZES MORE EASILY THAN COPPER DOES, THE ZINC ATOMS LEAVE ELECTRONS ON THE ZINC PLATE TO BECOME ZINC IONS (Zn^{2+}) AND THE ZINC DISSOLVES IN THE DILUTED SULFURIC ACID.

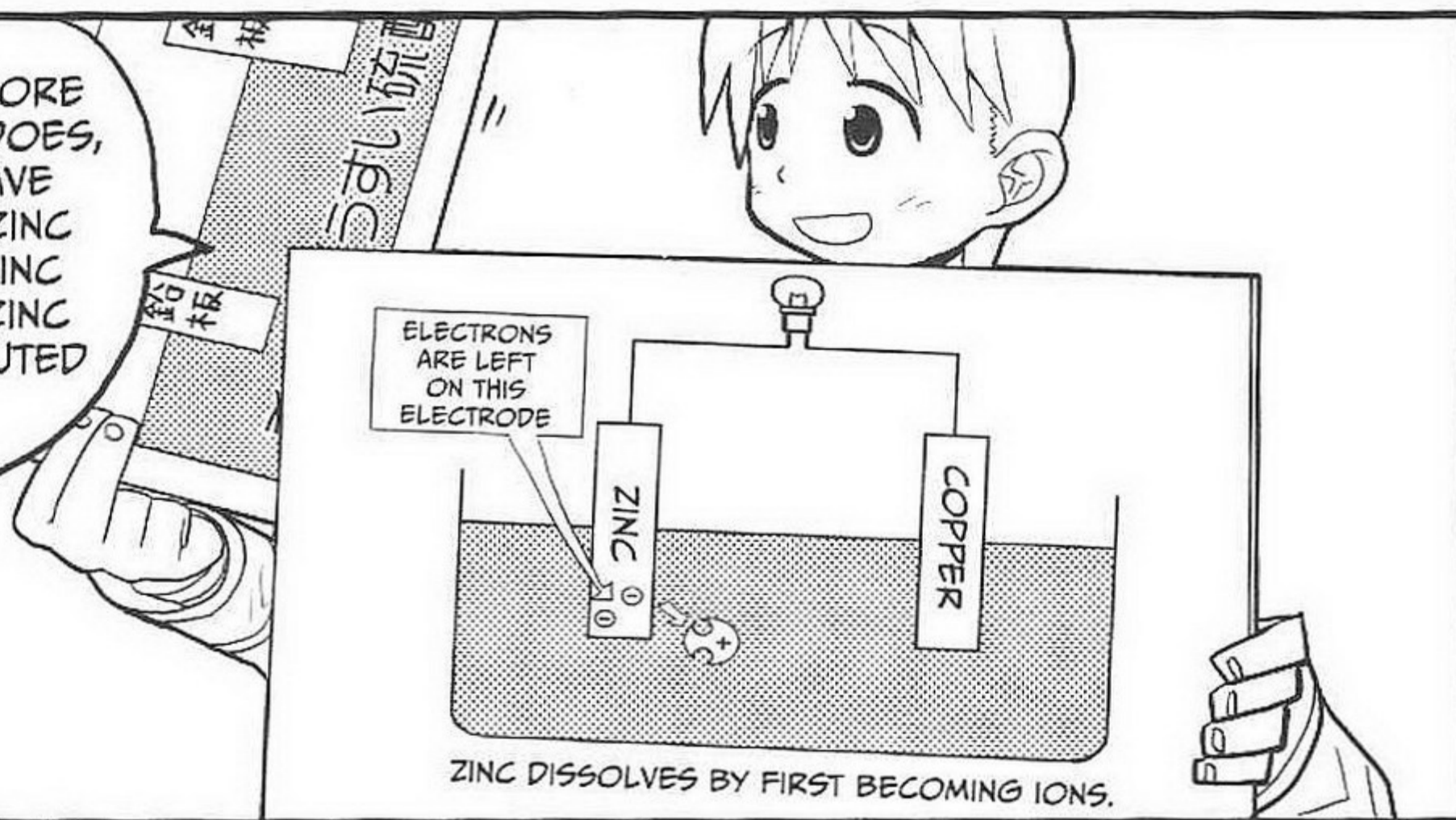

WHAT IS AN ION?

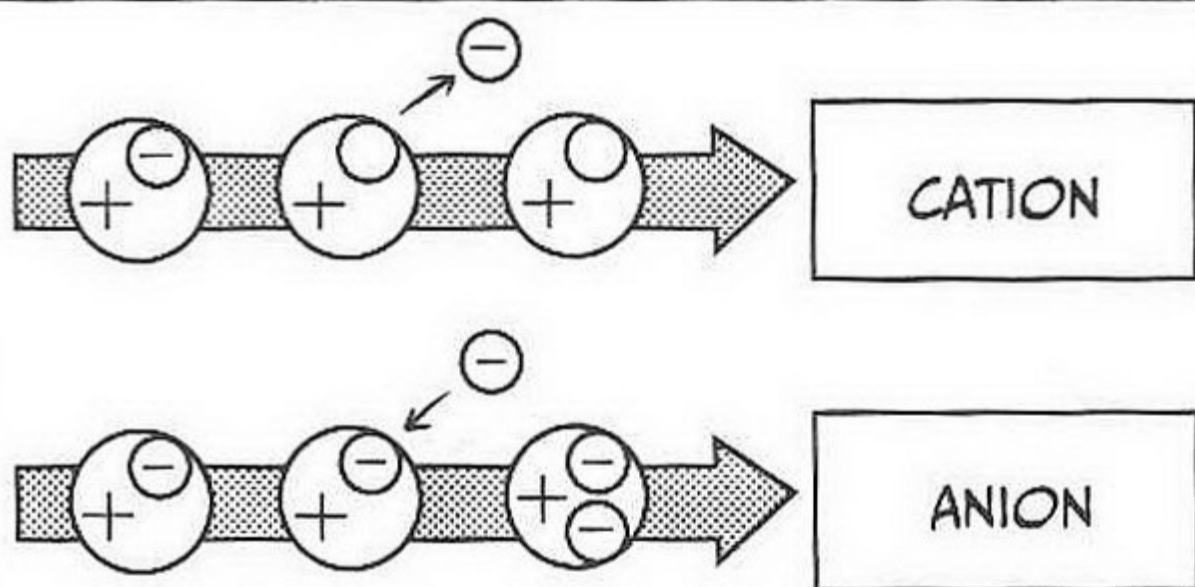
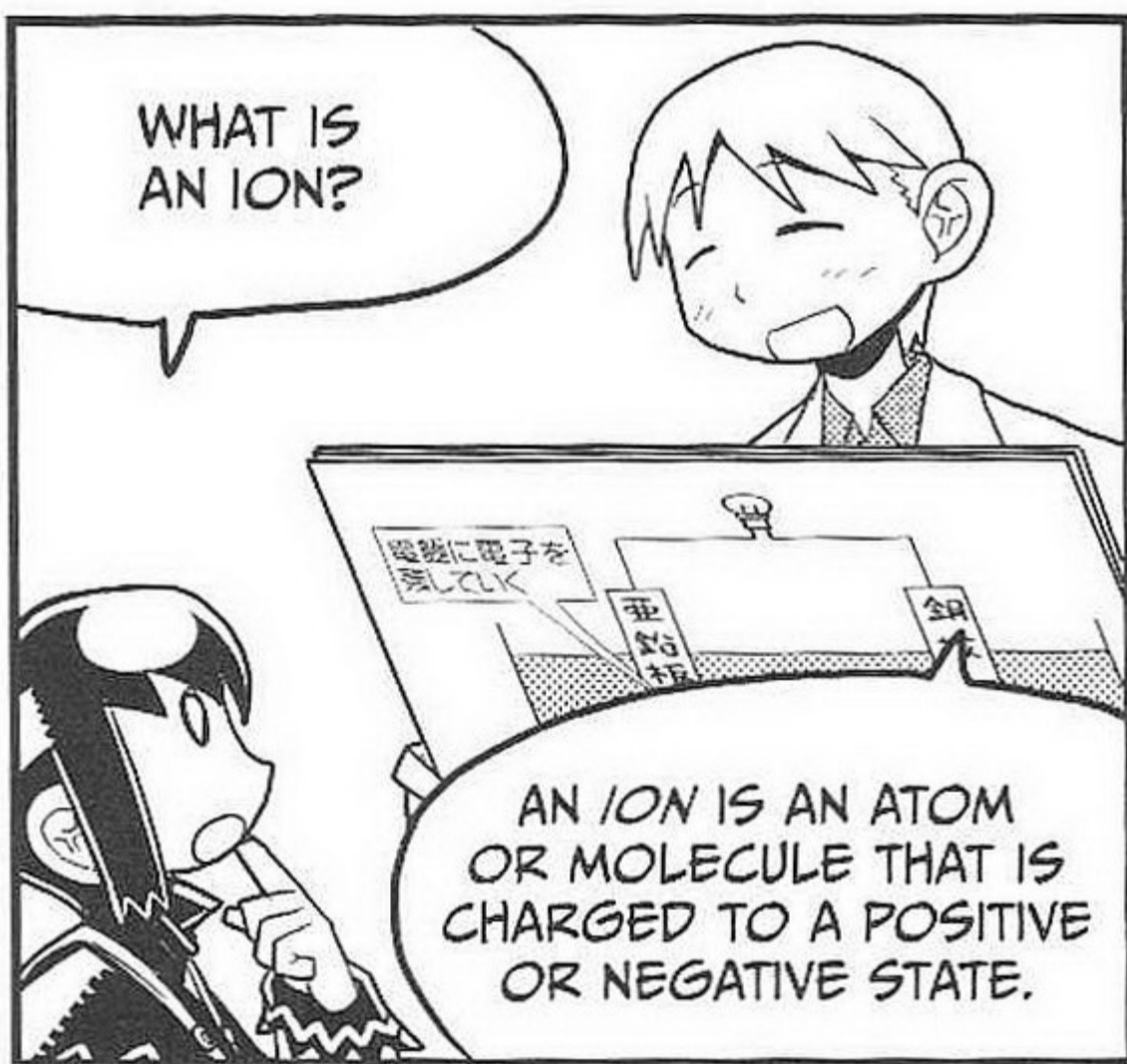

IF IT'S POSITIVE, IT'S CALLED A **CATION**, AND IF IT'S NEGATIVE, IT'S CALLED AN **ANION**.

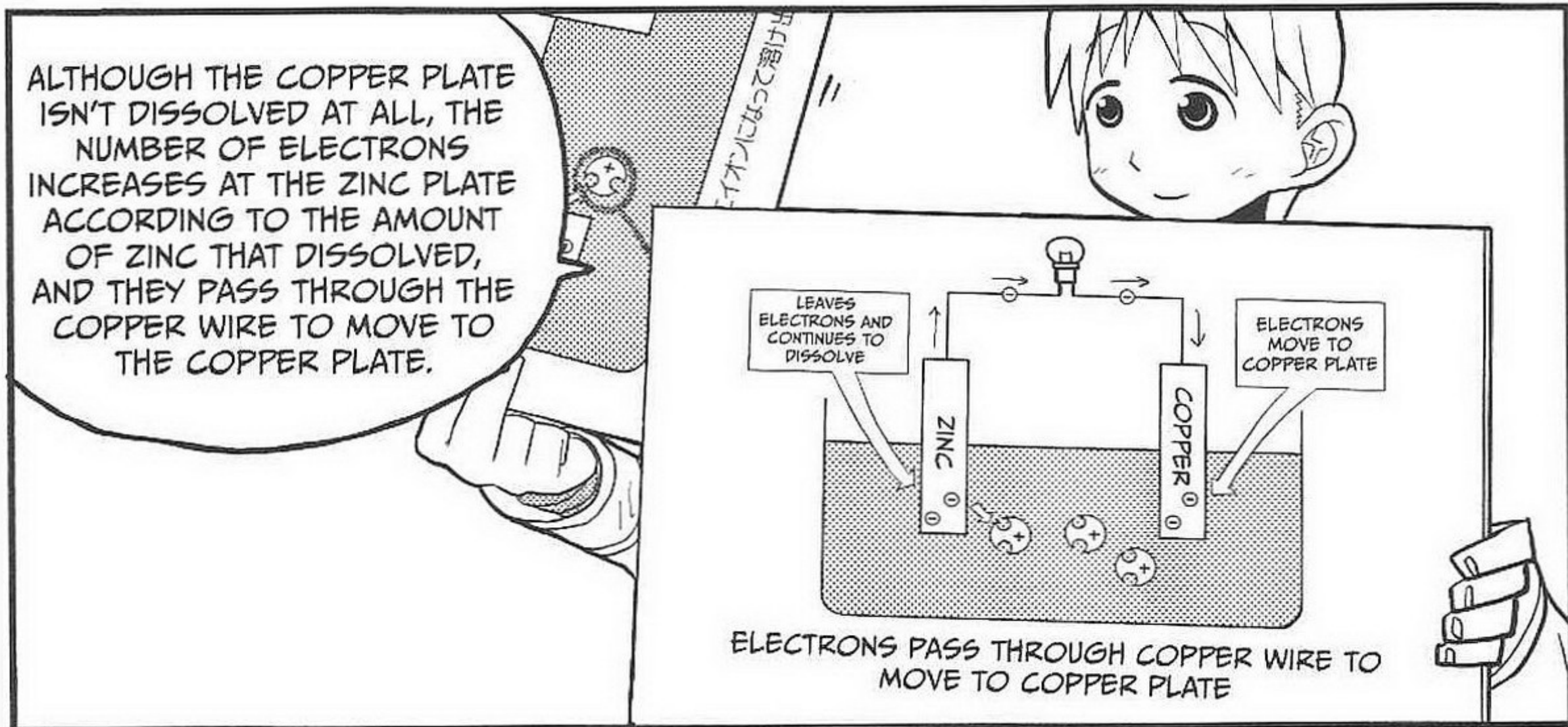
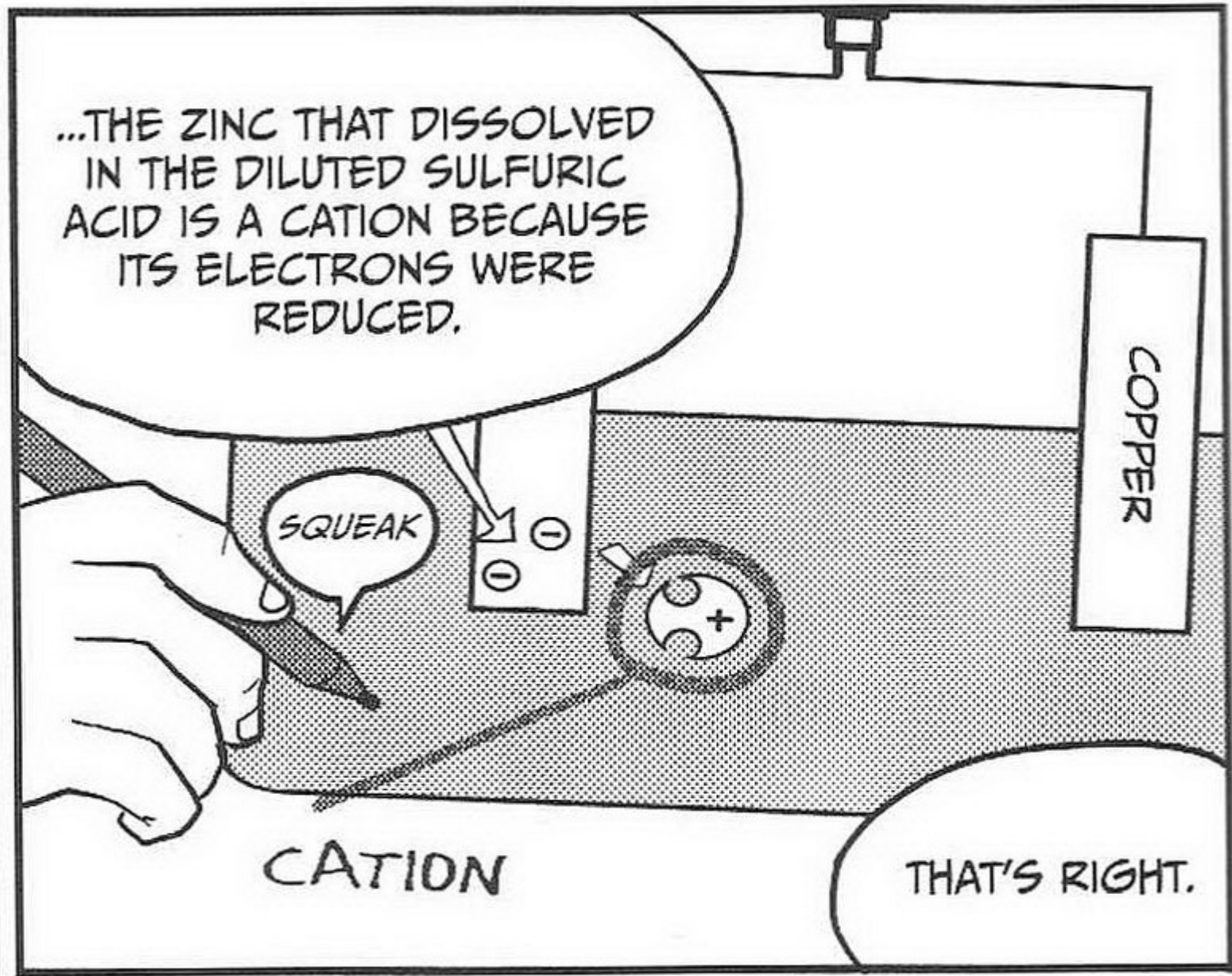

ALTHOUGH HYDROGEN IONS H^+ AND SULFURIC ACID IONS SO_4^{2-} EXIST IN THE DILUTED SULFURIC ACID...

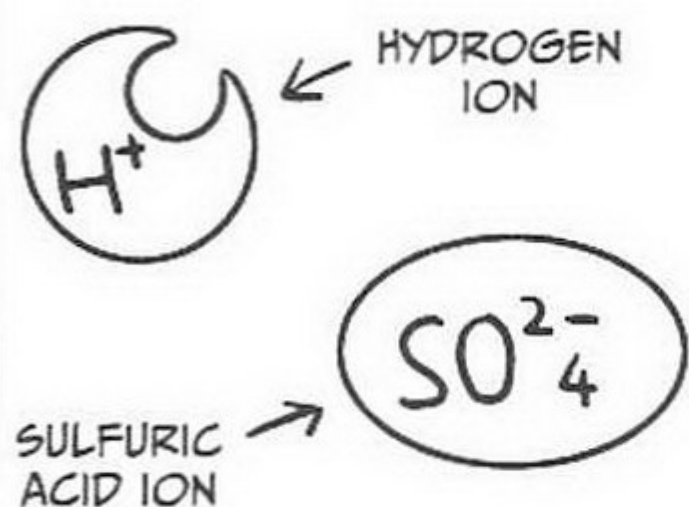

IF ZINC IONS ARE PRODUCED THERE, THE HYDROGEN, WHICH HAS A WEAKER IONIZATION TENDENCY THAN ZINC...

...UNITES WITH THE ELECTRONS THAT MOVED TO THE COPPER PLATE AND BECOMES HYDROGEN GAS.

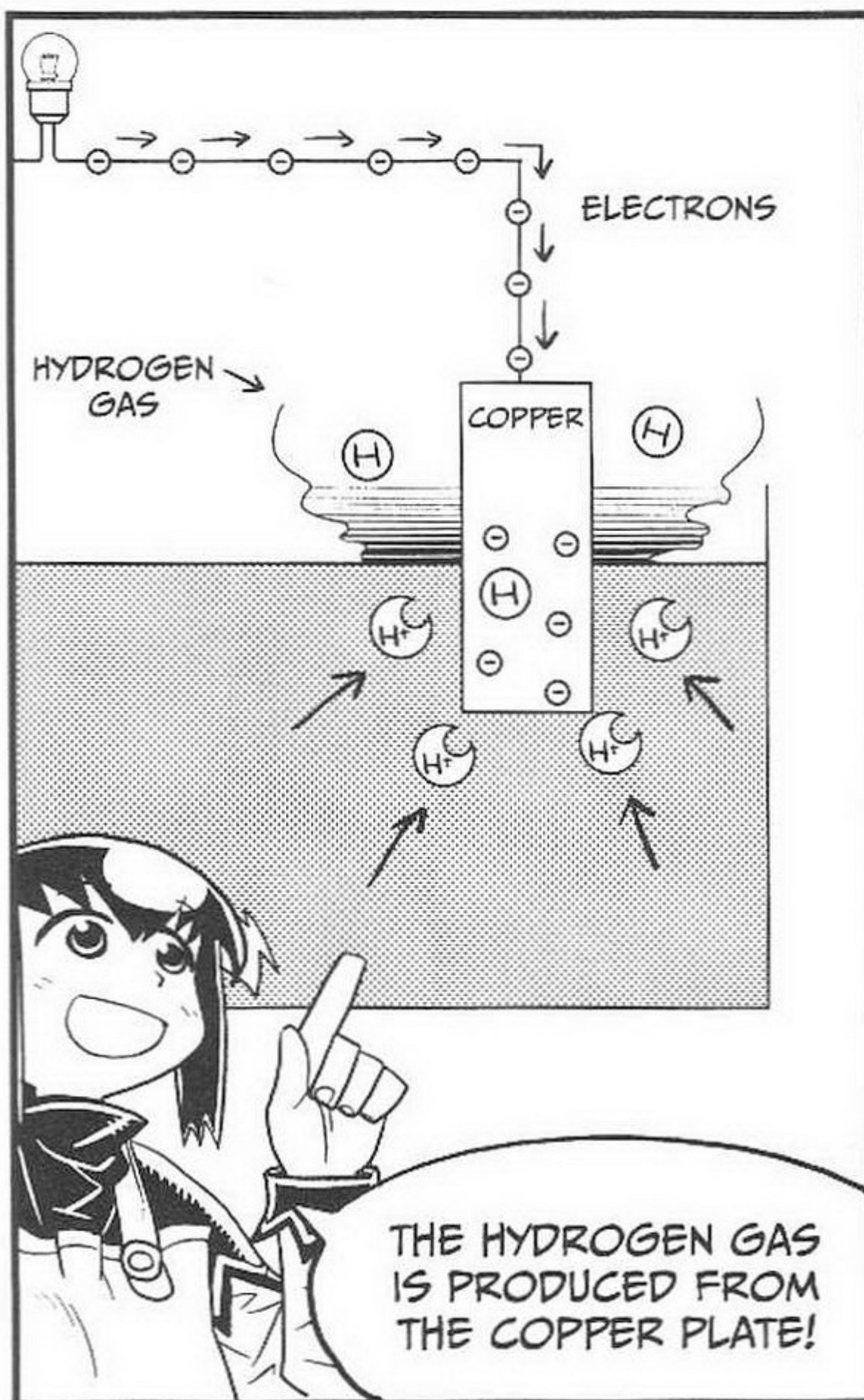
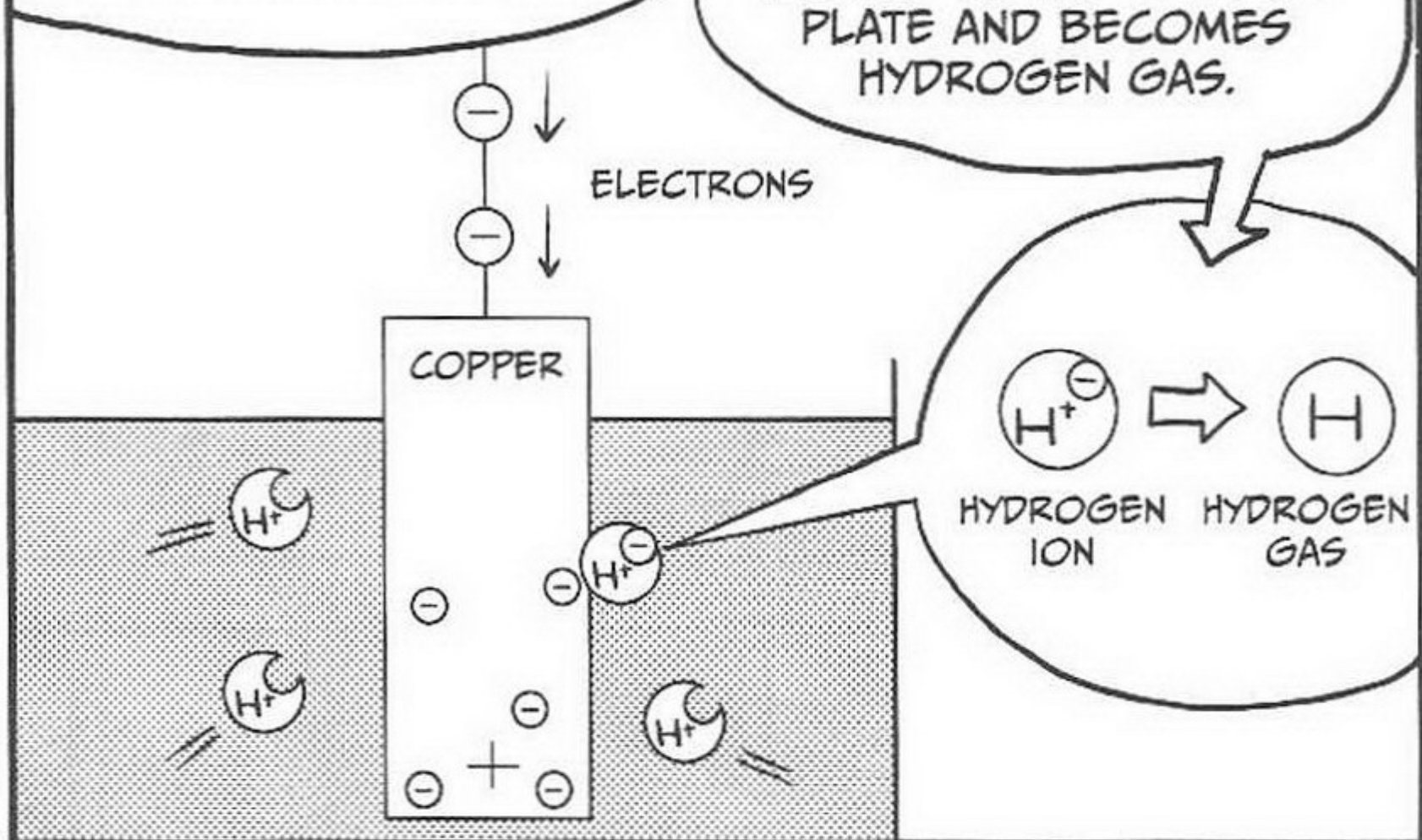

THE HYDROGEN GAS IS PRODUCED FROM THE COPPER PLATE!

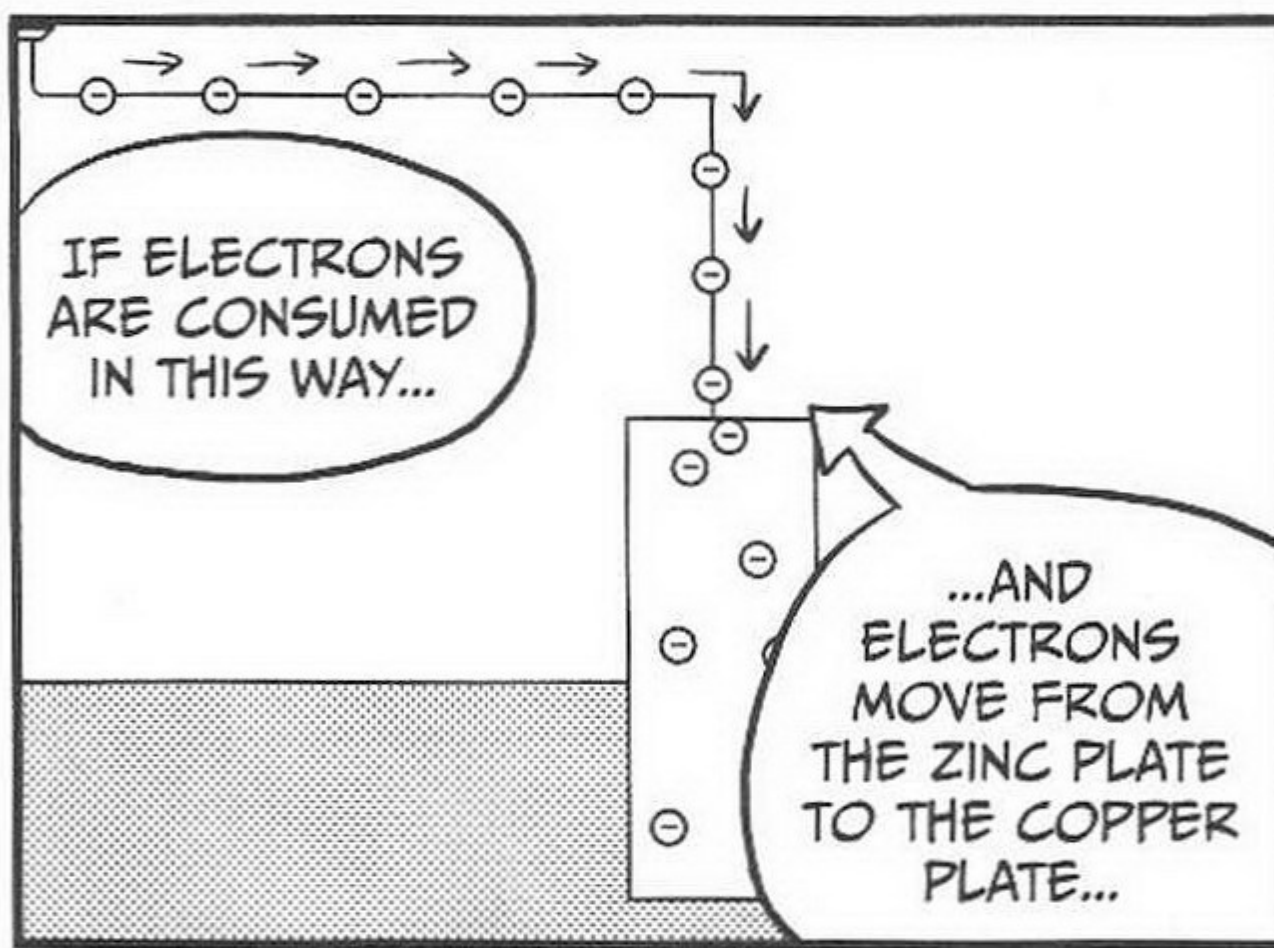

IF ELECTRONS ARE CONSUMED IN THIS WAY...

...AND ELECTRONS MOVE FROM THE ZINC PLATE TO THE COPPER PLATE...

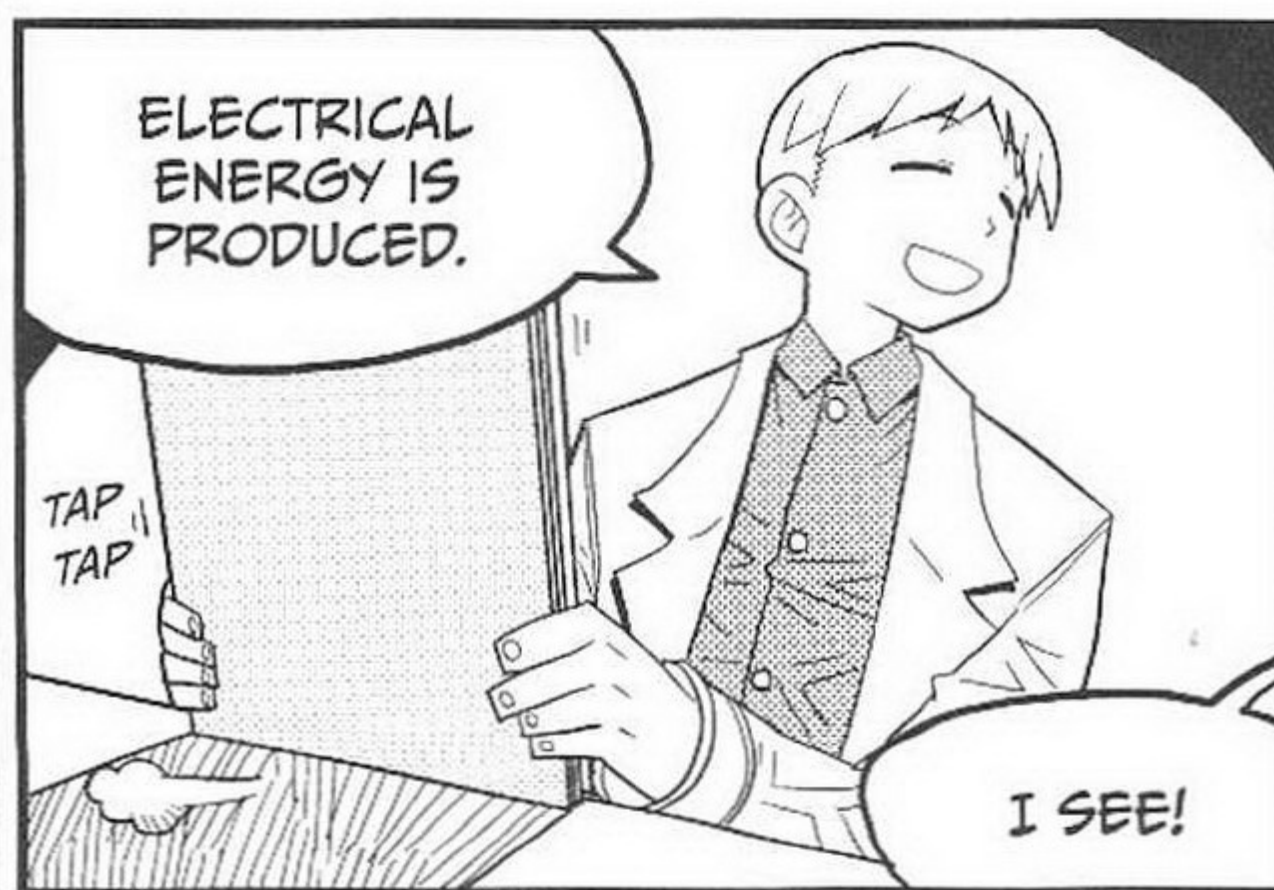

ELECTRICAL ENERGY IS PRODUCED.

I SEE!

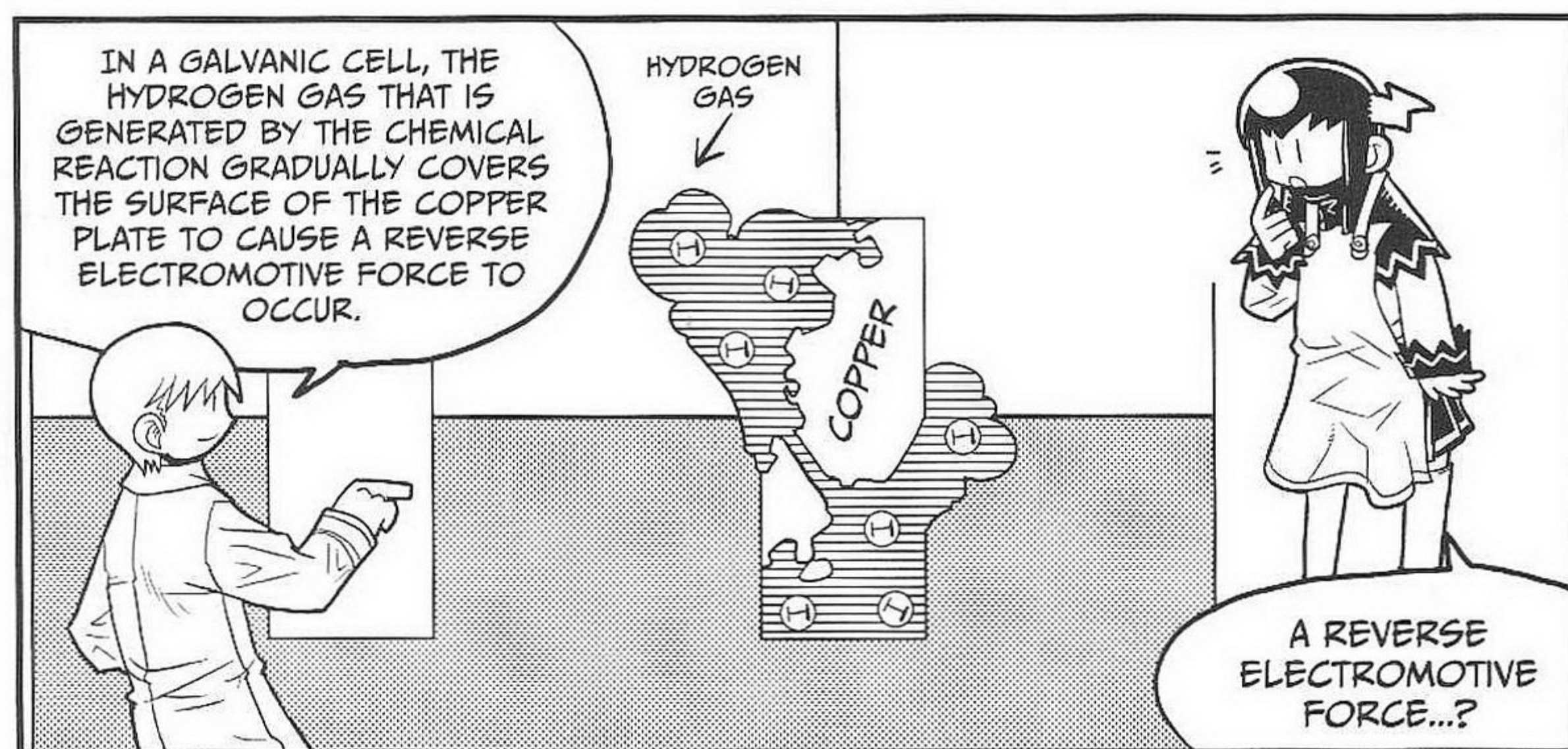
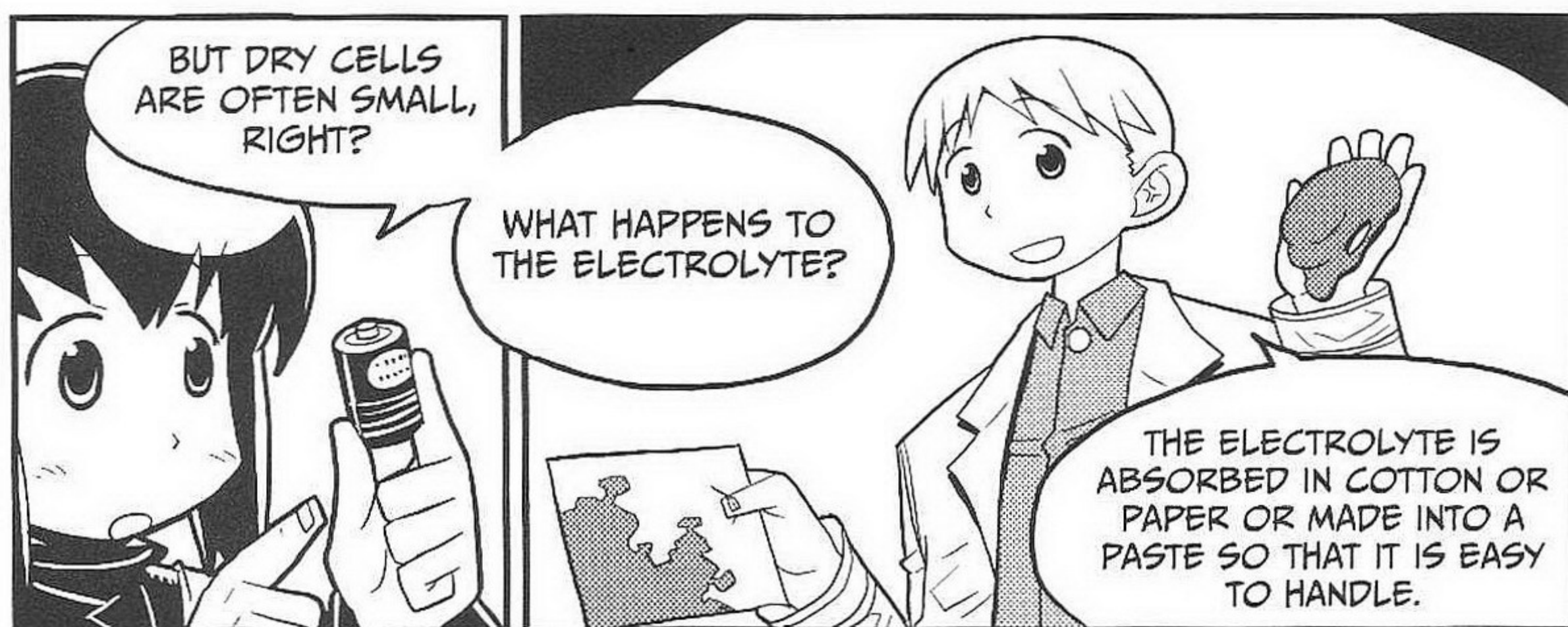
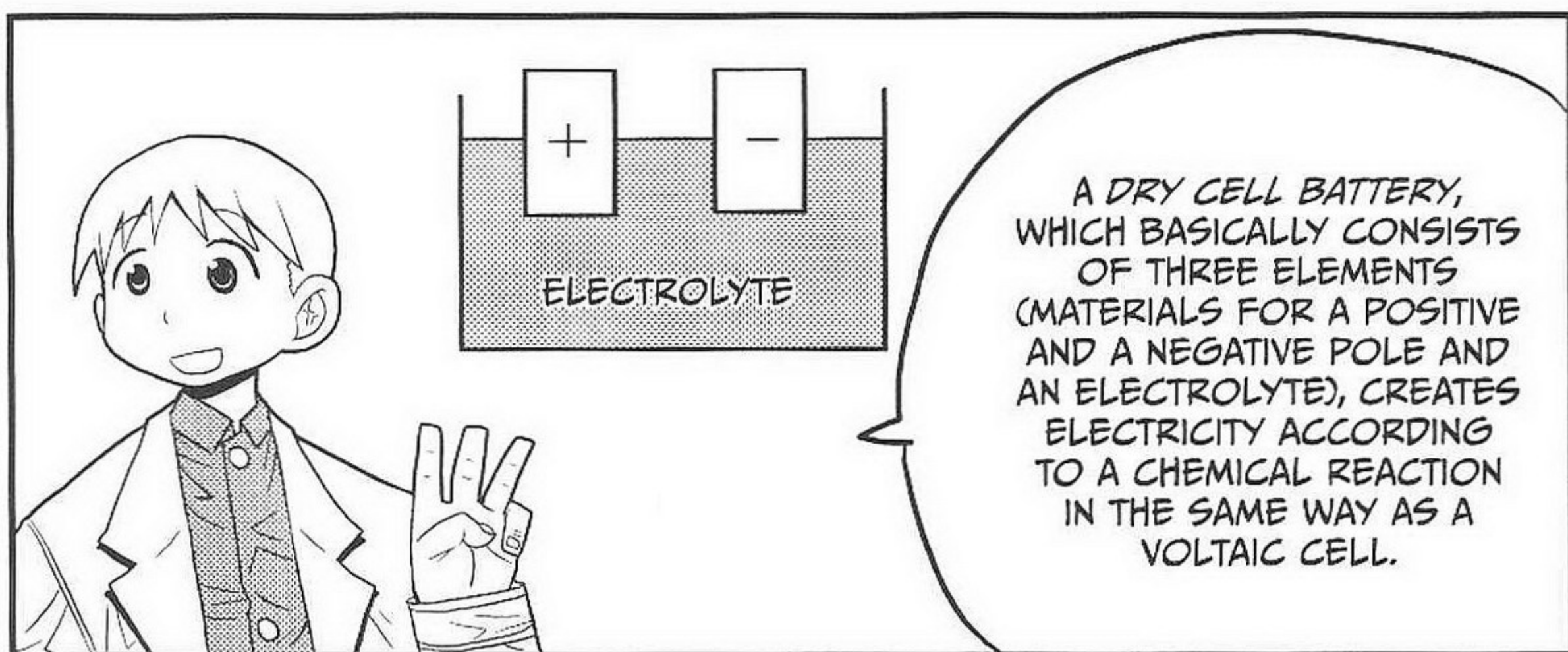

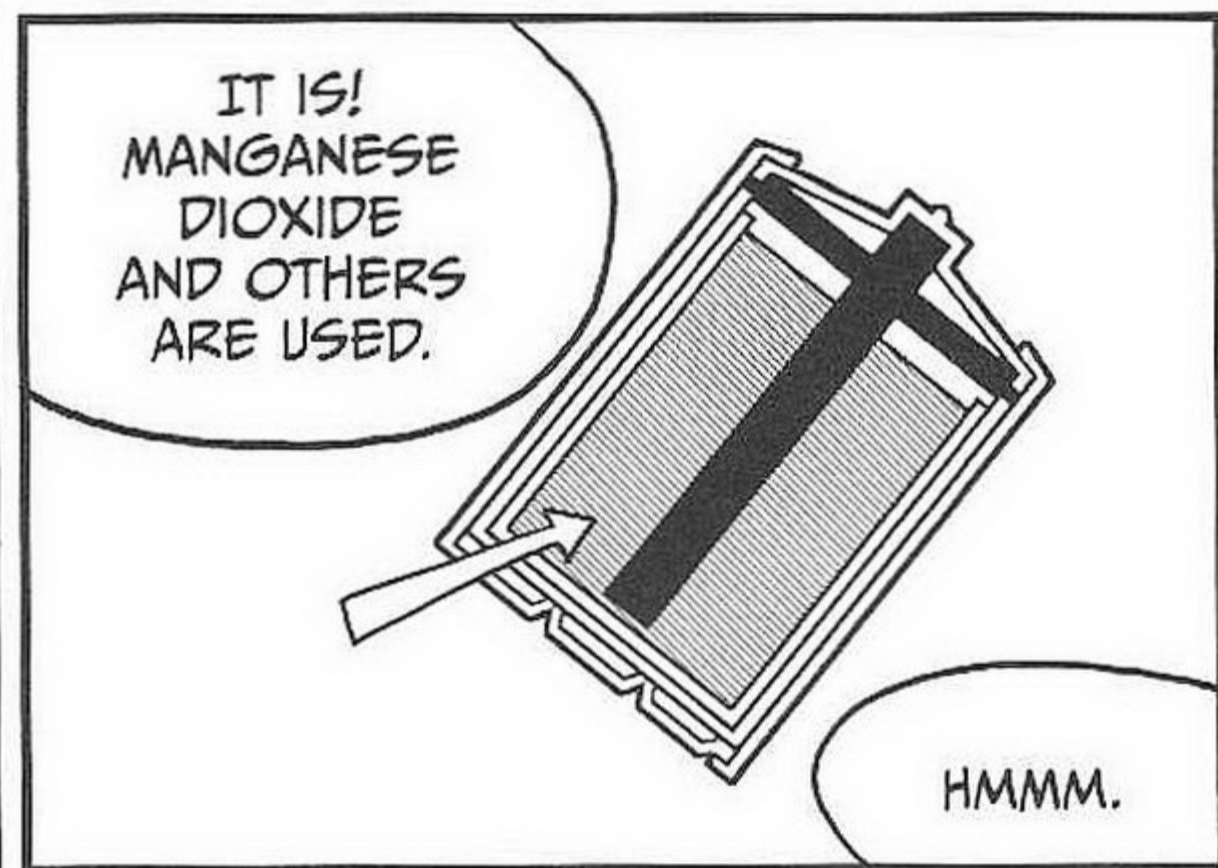
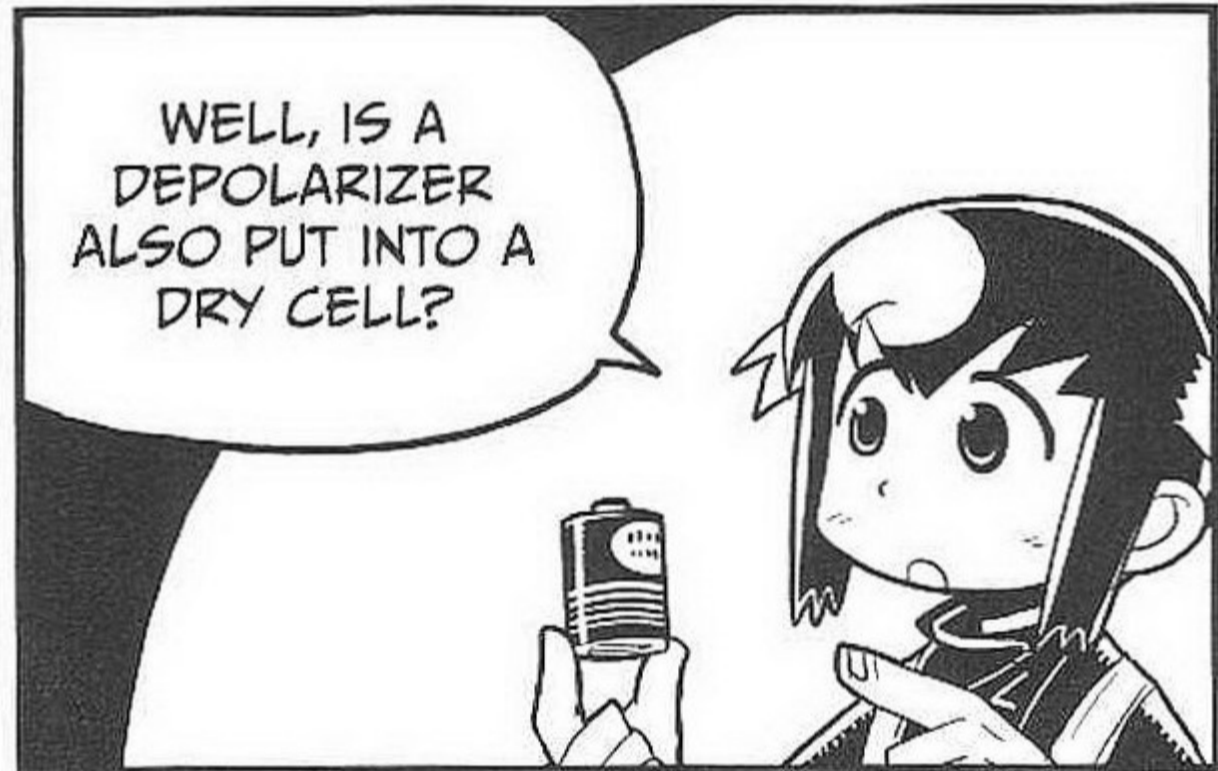
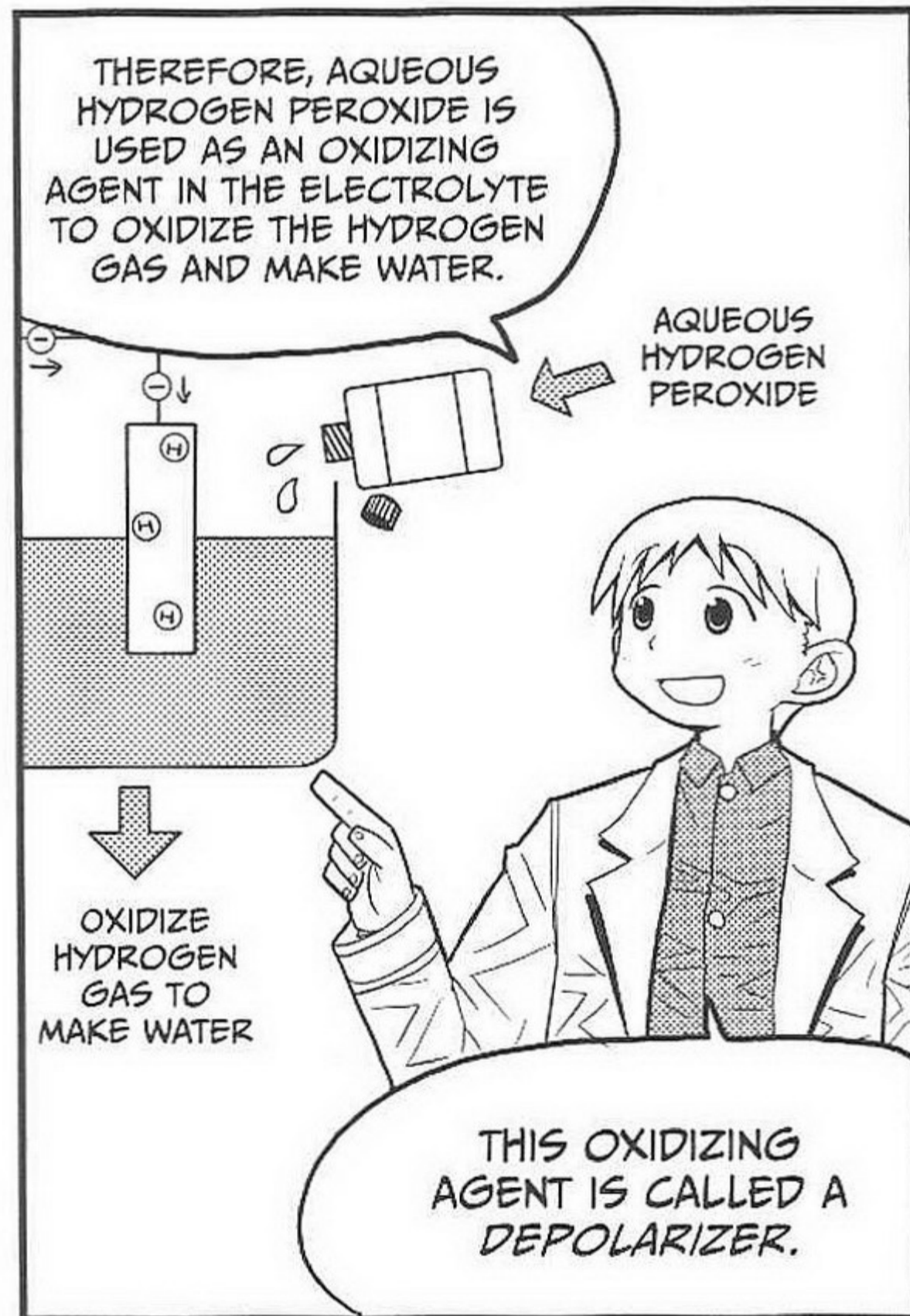
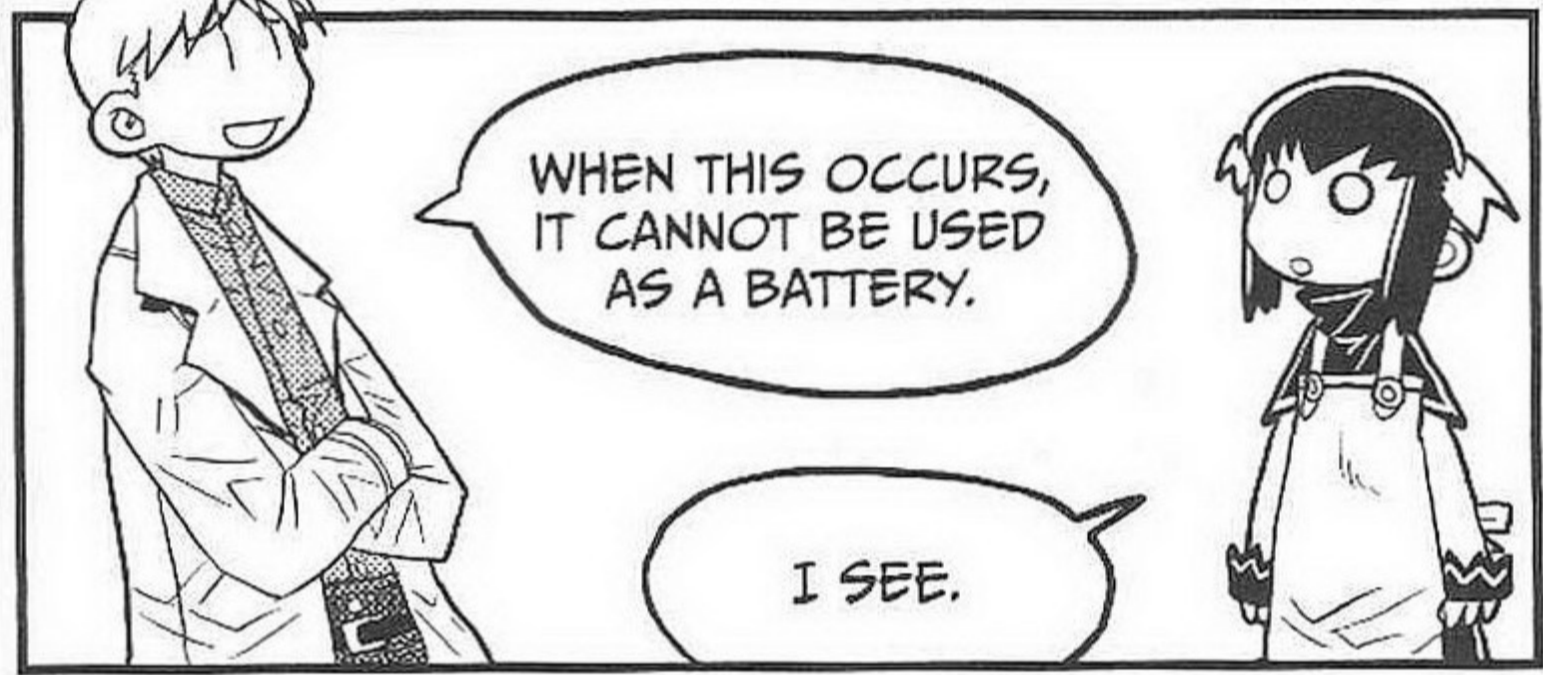
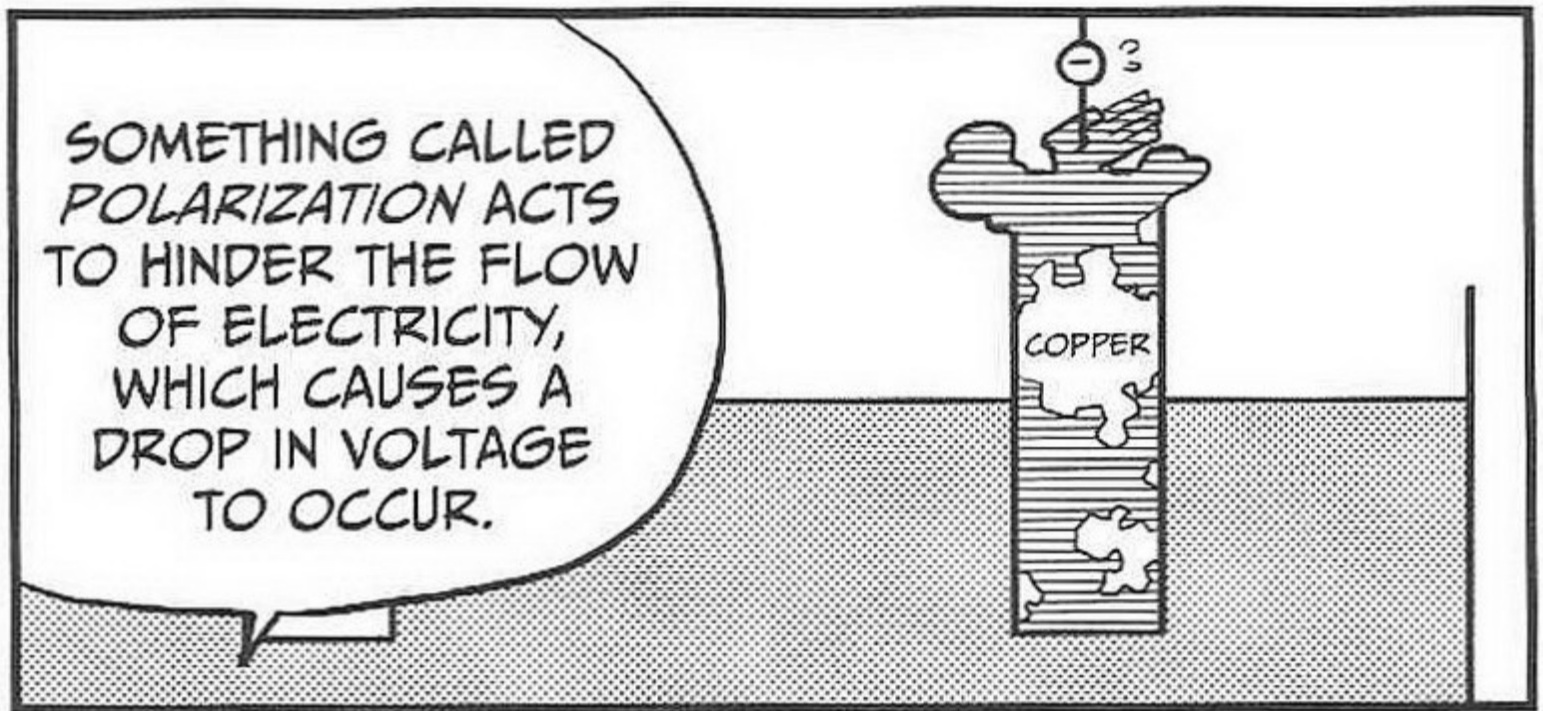



IN TECHNICAL TERMS, A CHEMICAL CELL CREATES ELECTRICITY THROUGH A REDUCTION-OXIDATION (REDOX) REACTION OF THE POSITIVE POLE AND NEGATIVE POLE.



WHAT HAPPENS IN A DRY CELL BATTERY?



INTERIOR OF A MANGANESE DRY CELL

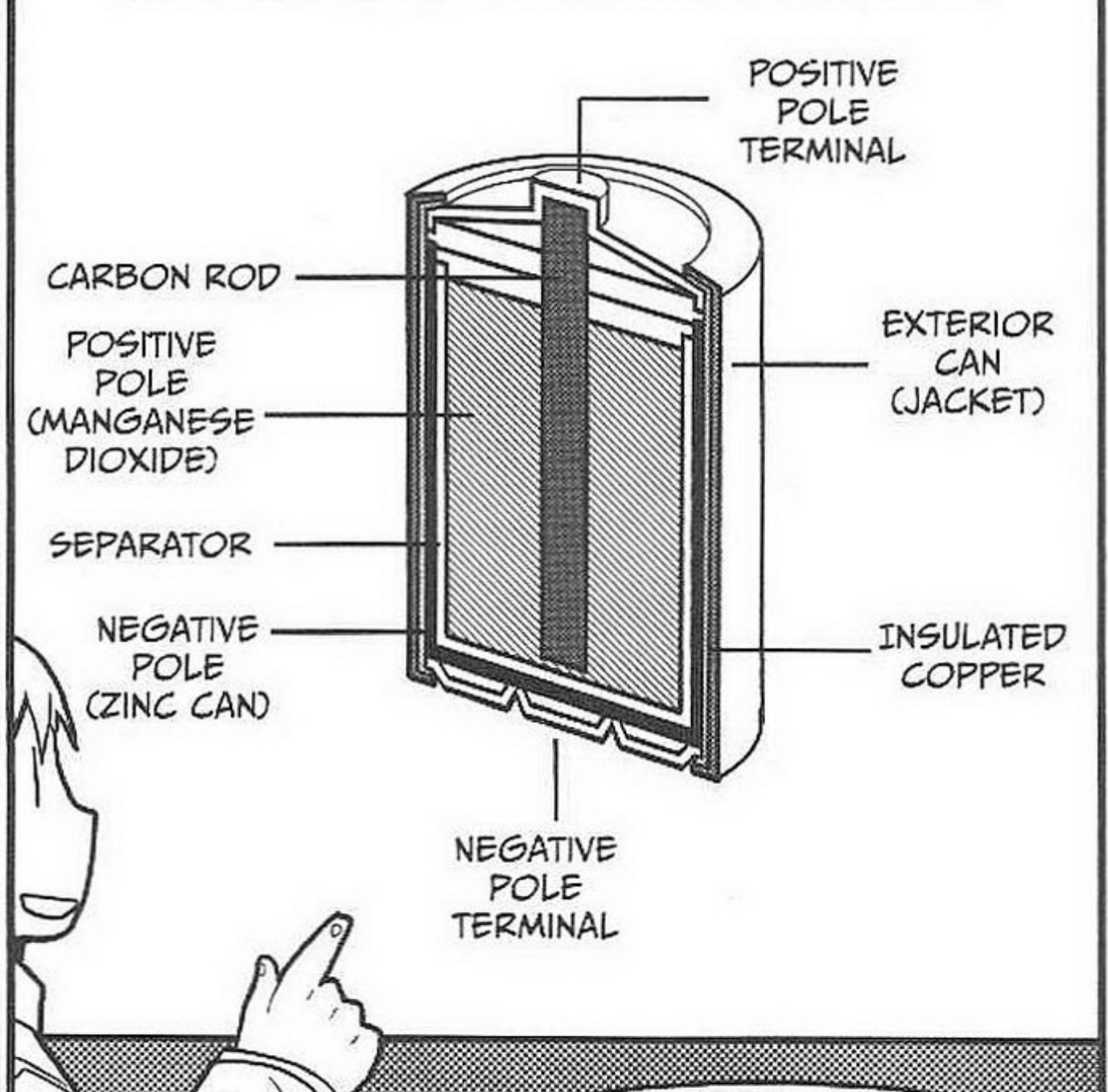

A MANGANESE DRY CELL BATTERY CONSISTS OF THE POSITIVE POLE COMPOUND, WHICH IS MIXED MANGANESE DIOXIDE FOR THE POSITIVE POLE AND A ZINC CHLORIDE SOLUTION FOR THE ELECTROLYTE, AND A ZINC CAN, WHICH IS THE OUTER NEGATIVE POLE MATERIAL.

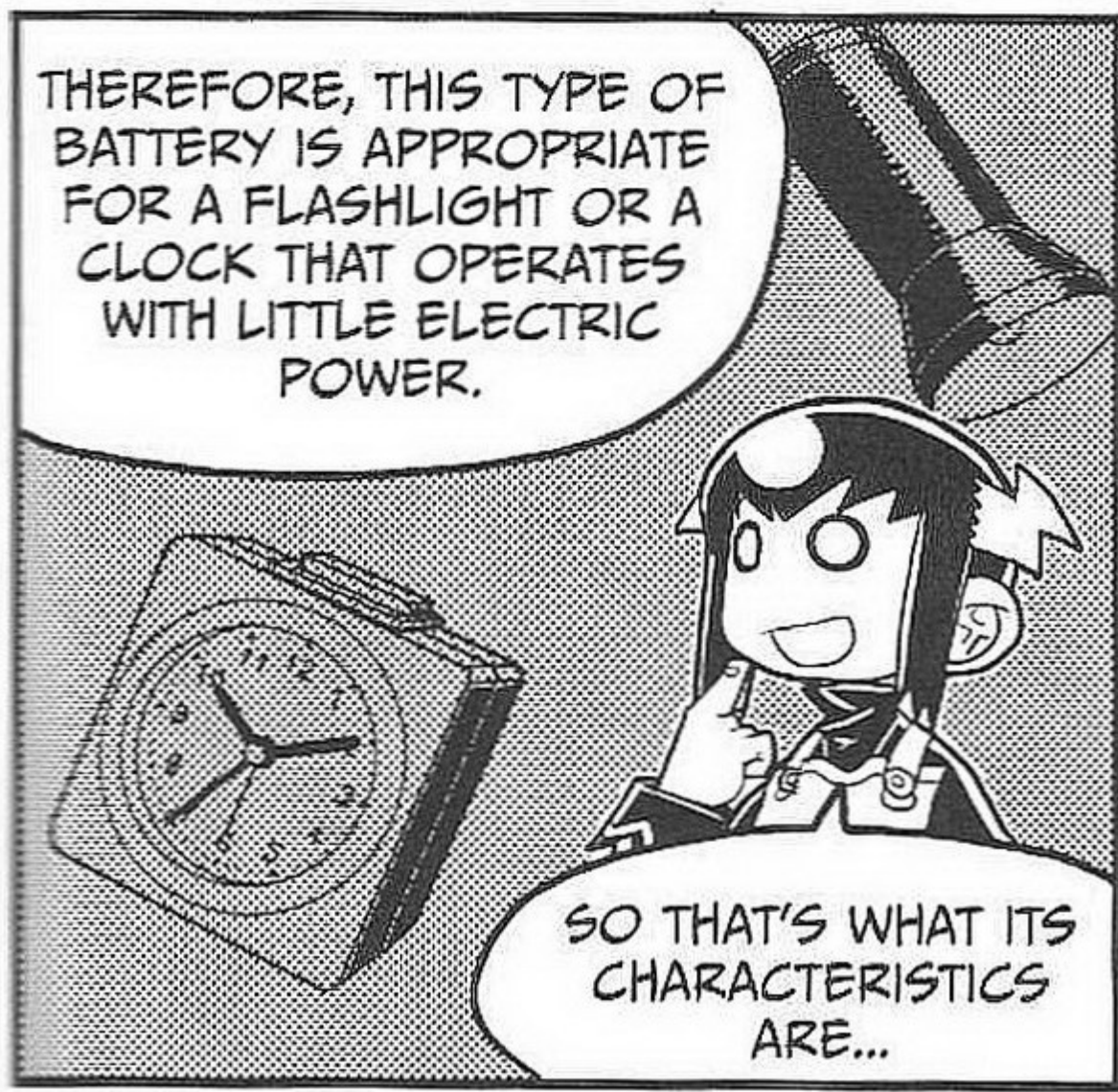
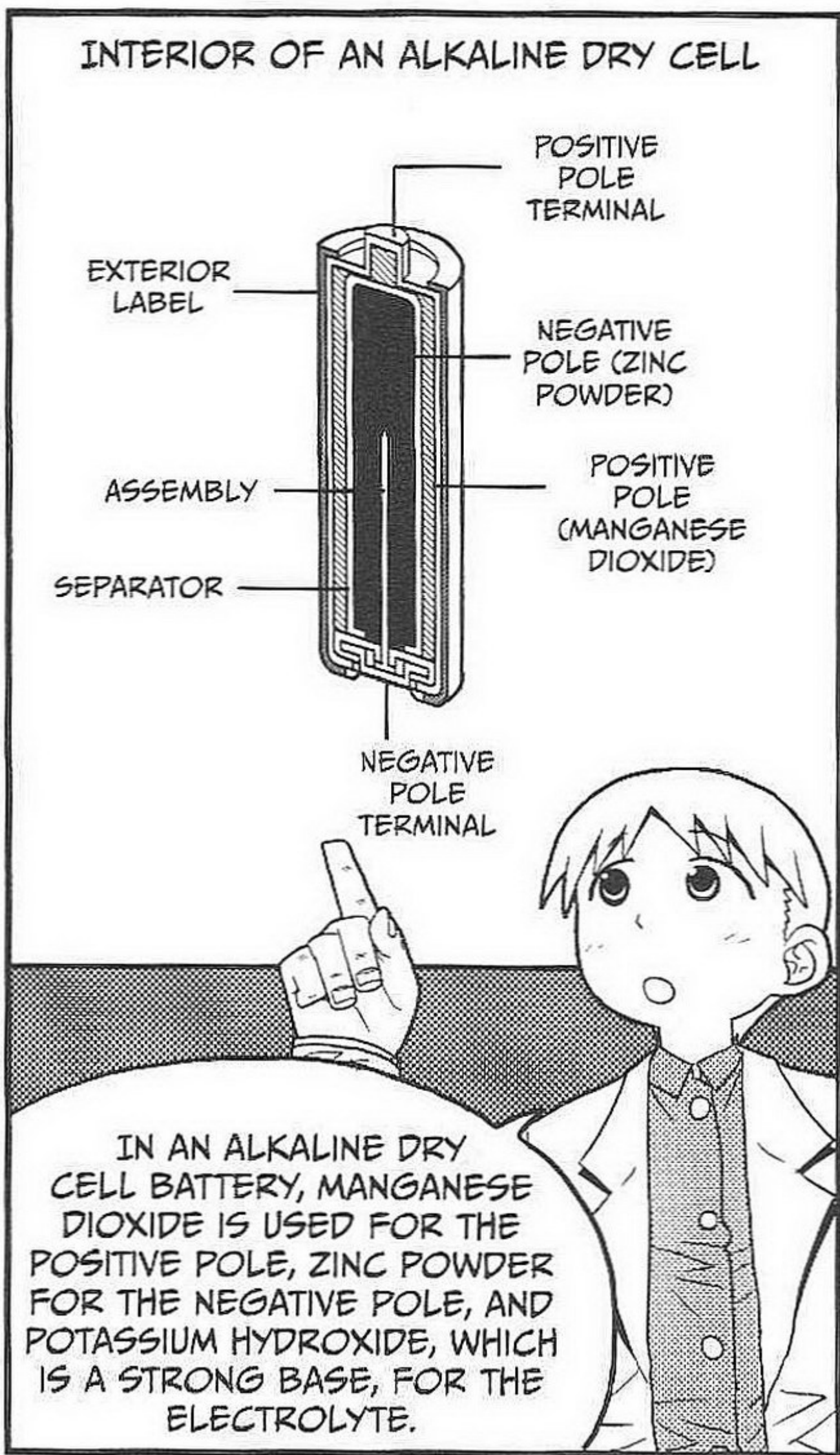
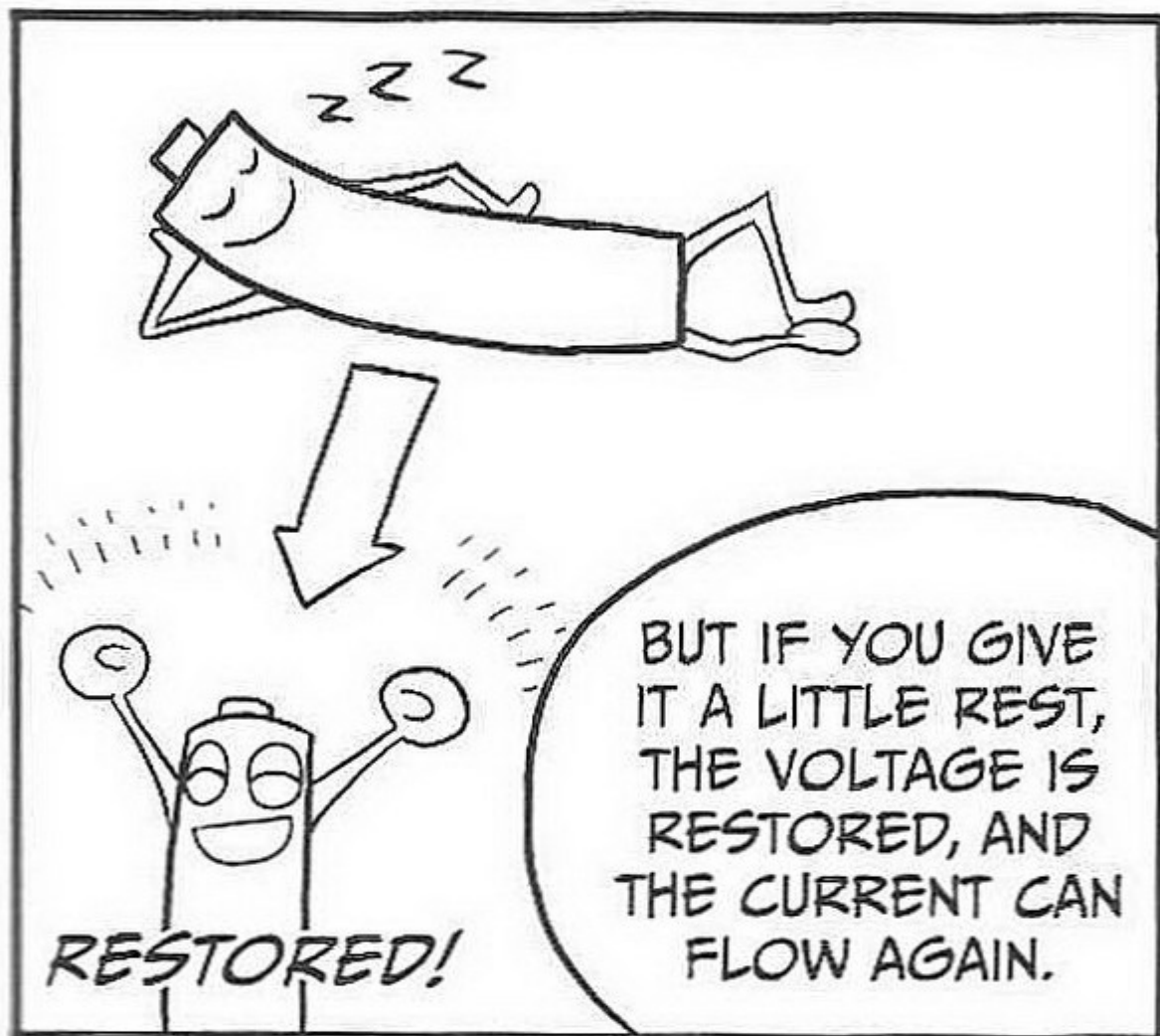
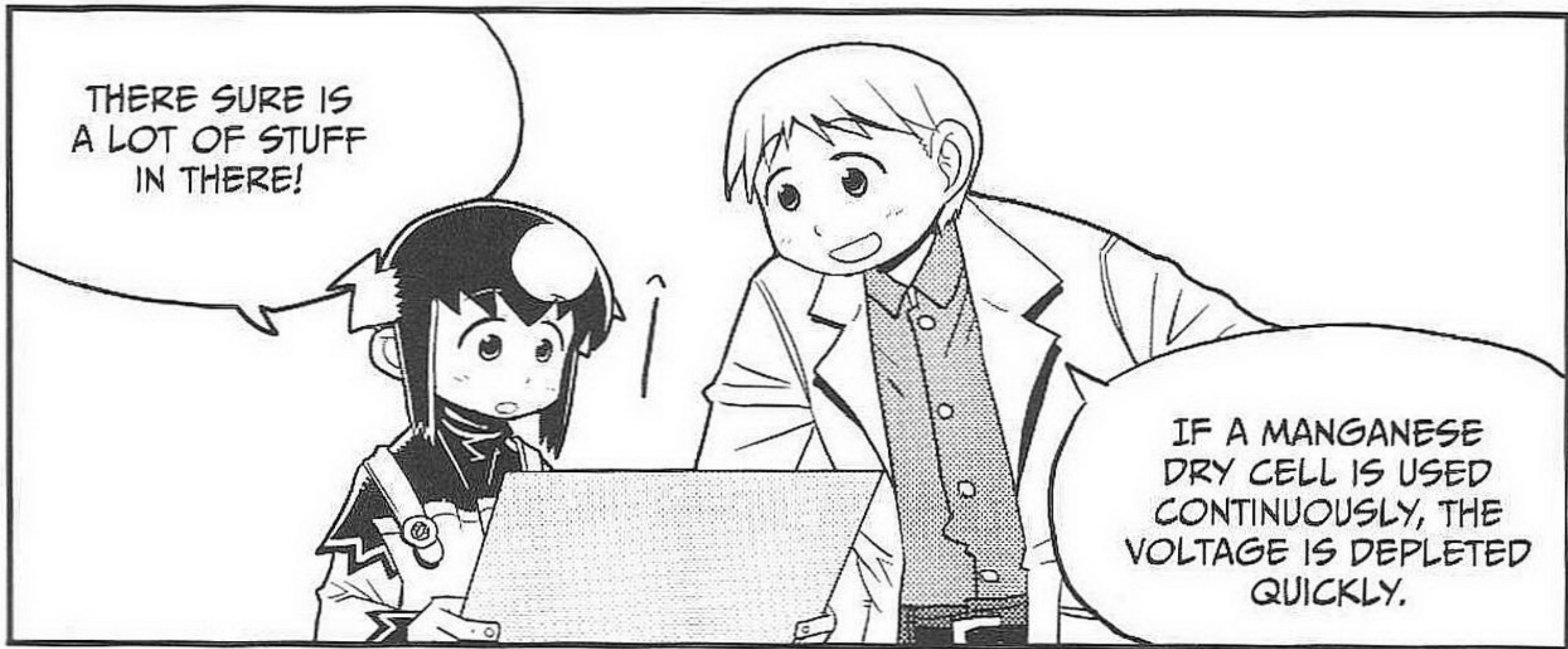

ALTHOUGH THE MANGANESE DRY CELL AND THE ALKALINE DRY CELL LOOK ALIKE ON THE OUTSIDE, THEIR INSIDES ARE RATHER DIFFERENT, AREN'T THEY?

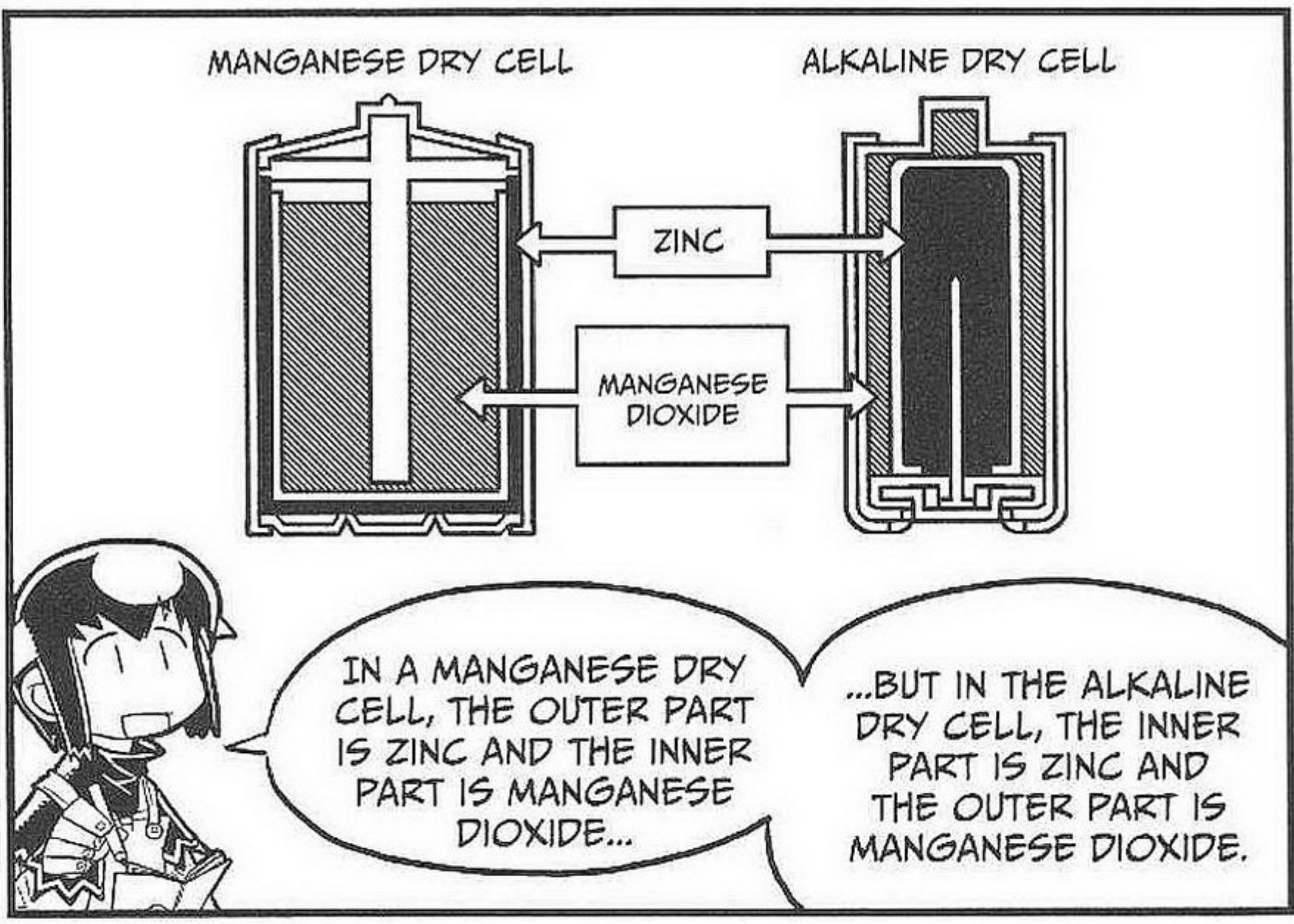

SINCE THE ALKALINE DRY CELL IS STRUCTURED TO CONTAIN A LOT OF MANGANESE DIOXIDE AND ZINC, IT PROVIDES GREATER CURRENT AND HAS A LONGER LIFETIME.

THEREFORE, AN ALKALINE DRY CELL IS SUITABLE FOR THE POWER SUPPLY OF A DEVICE THAT REQUIRES A LARGE CURRENT, SUCH AS A MOTOR.

I SEE.

MANGANESE DRY CELL

IF IT'S GIVEN A REST, ITS VOLTAGE IS RESTORED.

CLOCK FLASHLIGHT
REMOTE CONTROL

ALKALINE DRY CELL

ELECTRIC POWER FLOWS CONTINUOUSLY.

MOTOR DIGITAL CAMERA
PORTABLE RADIO

IF YOU UNDERSTAND THE CHARACTERISTICS OF DRY CELLS, YOU'LL BE ABLE TO USE EACH TYPE IN EXACTLY THE RIGHT WAY.

THAT'S TRUE!

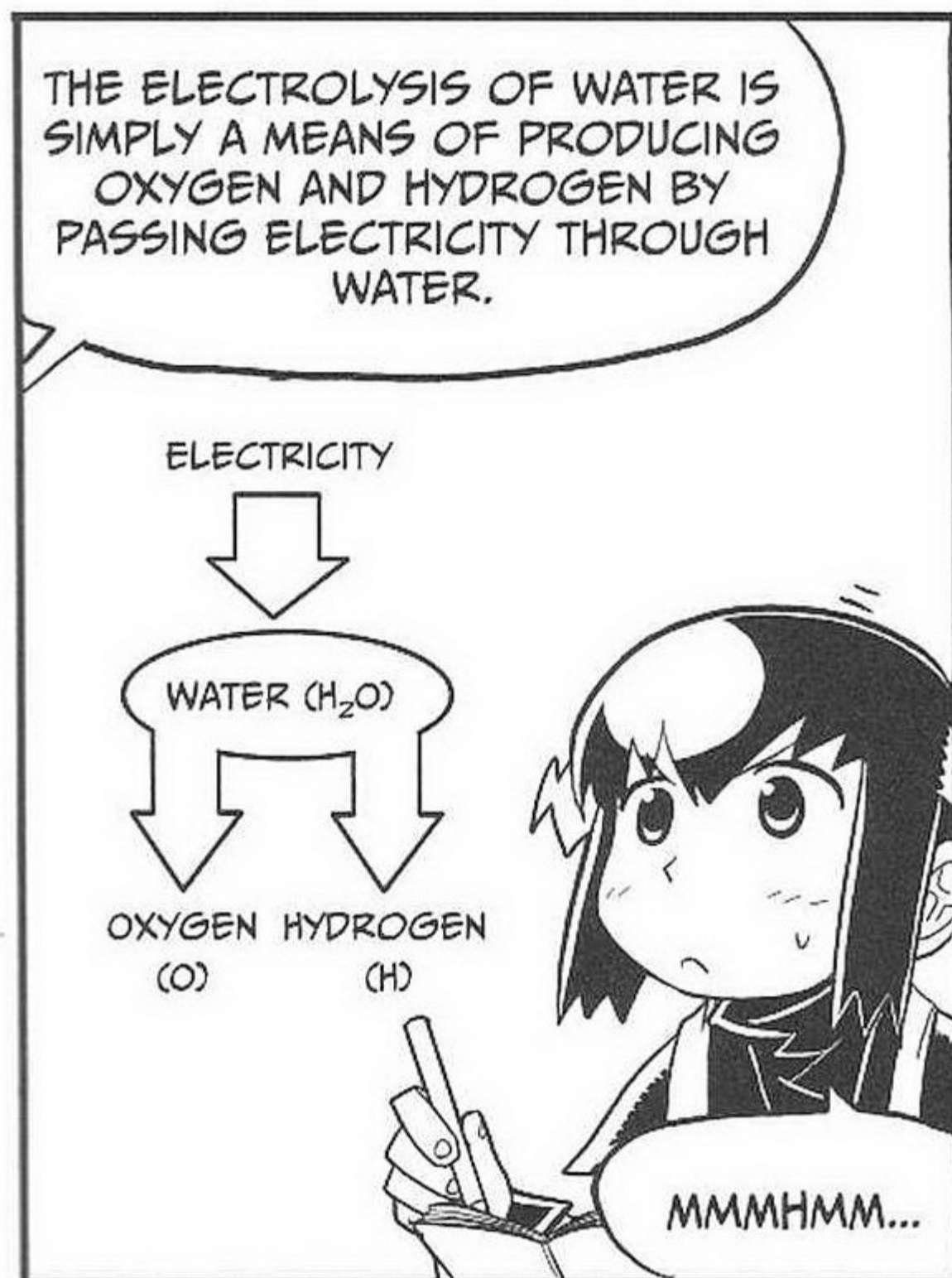

WHEN ELECTRICITY IS PASSED THROUGH IT, HYDROGEN AND OXYGEN ARE PRODUCED AT THE RESPECTIVE ELECTRODES, WHICH ARE PLATINUM OR ANOTHER NON-CORROSIVE METAL.

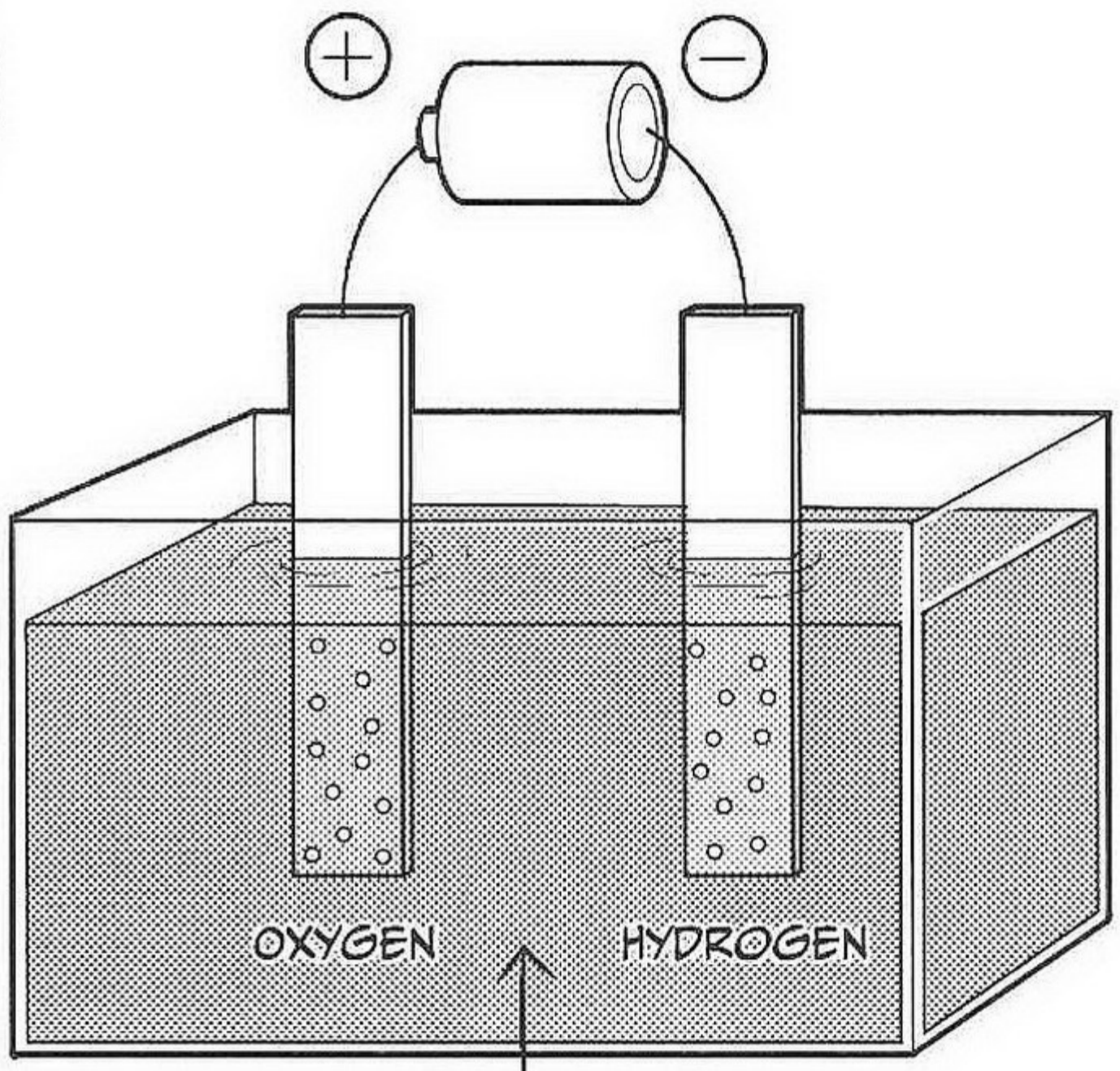
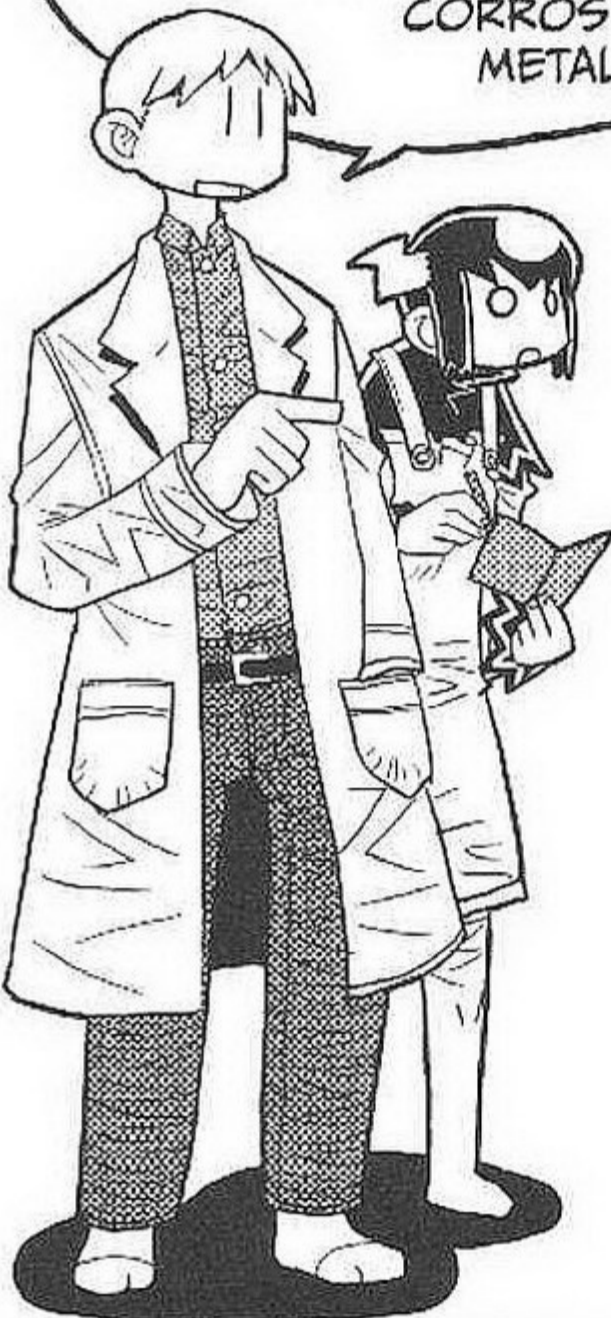

AQUEOUS SOLUTION OF SODIUM HYDROXIDE

INCIDENTALLY, IN ELECTROLYSIS, THE ELECTRODE THAT THE POSITIVE SIDE OF THE POWER SUPPLY IS CONNECTED TO IS CALLED THE ANODE...

...AND THE ELECTRODE THAT THE NEGATIVE SIDE OF THE POWER SUPPLY IS CONNECTED TO IS CALLED THE CATHODE.

I SEE!

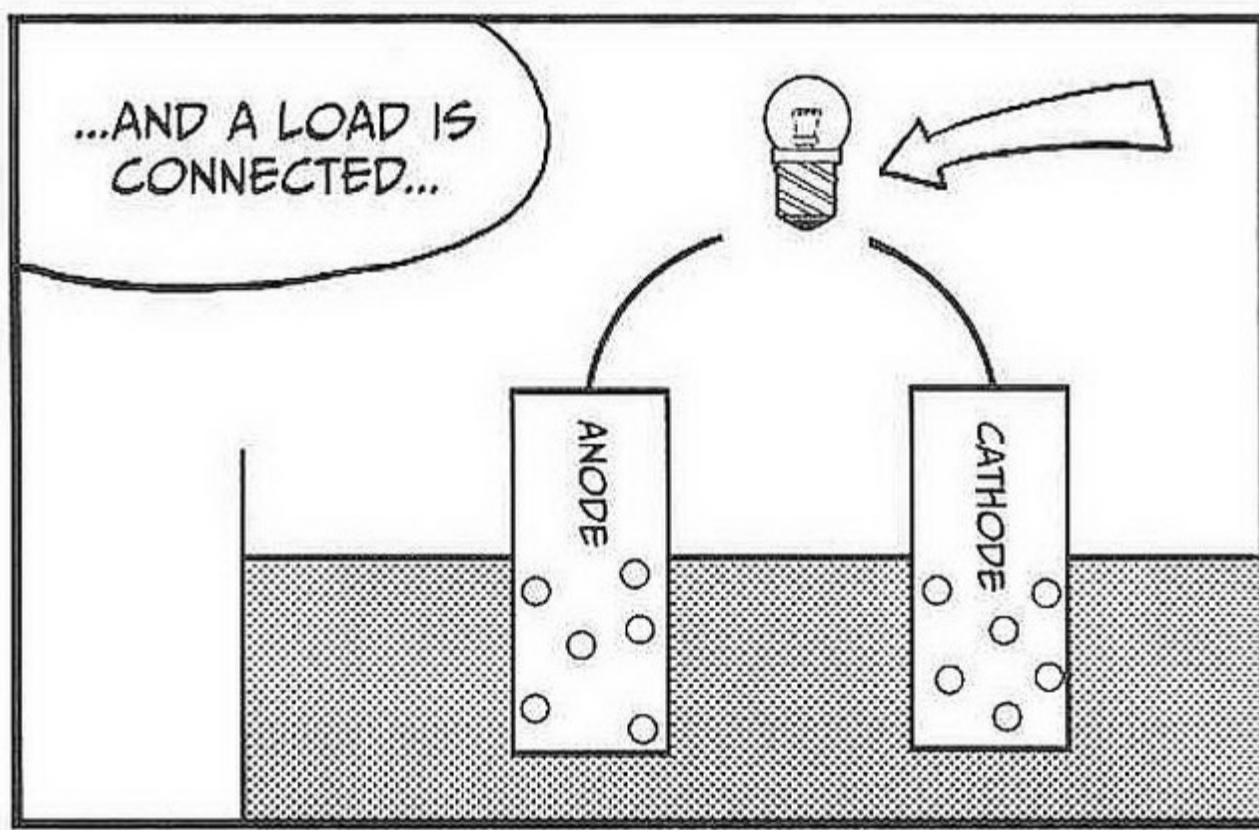
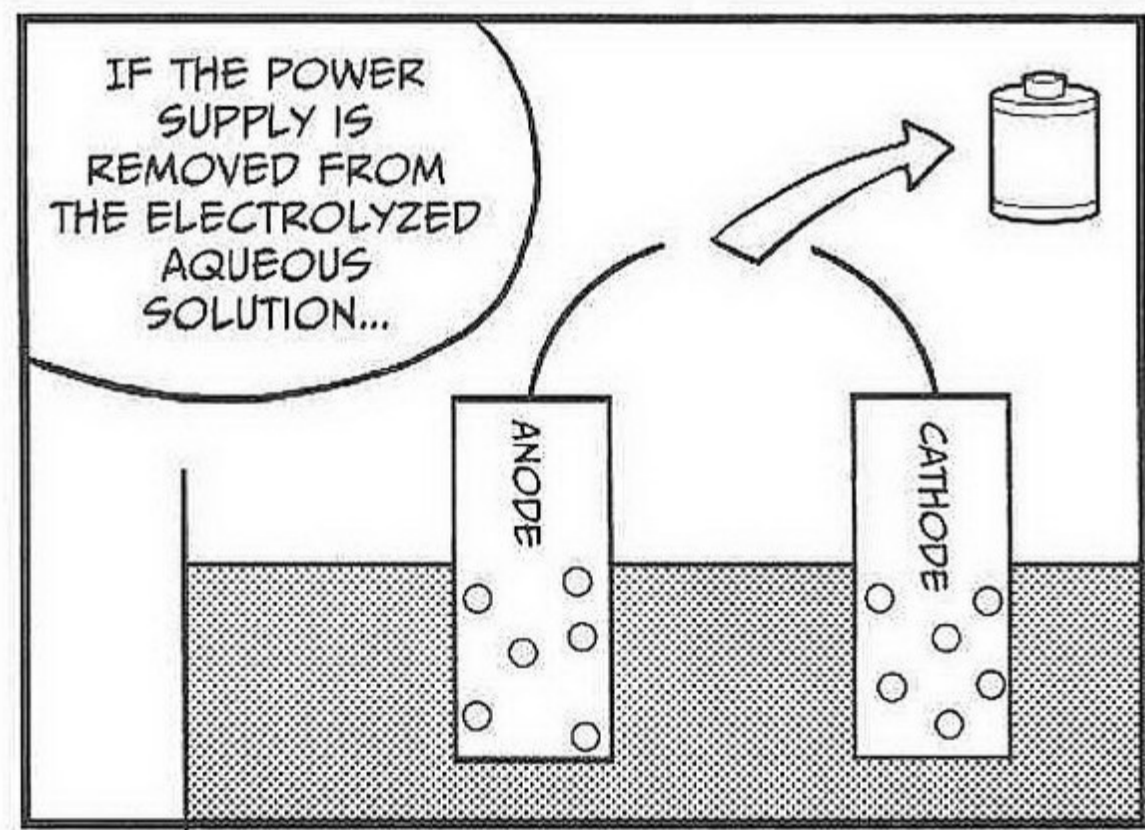

...THE DECOMPOSED HYDROGEN AND OXYGEN WILL COMBINE TO PRODUCE ELECTRICITY, WATER, AND HEAT. THIS IS THE PRINCIPLE OF A FUEL CELL.

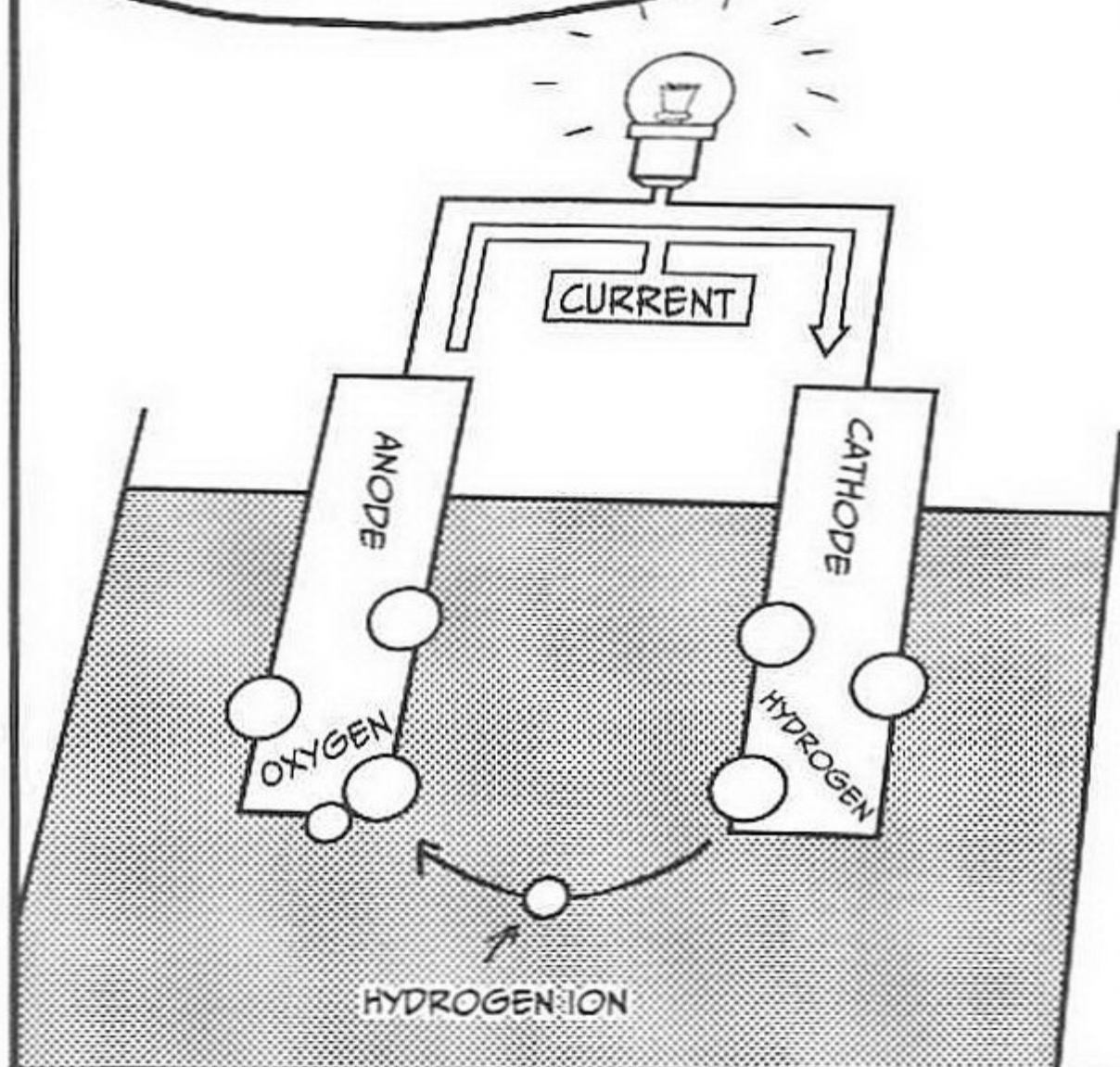

IF WE CONTINUE TO SUPPLY HYDROGEN AND OXYGEN, ELECTRICITY WILL CONTINUE TO BE CREATED.

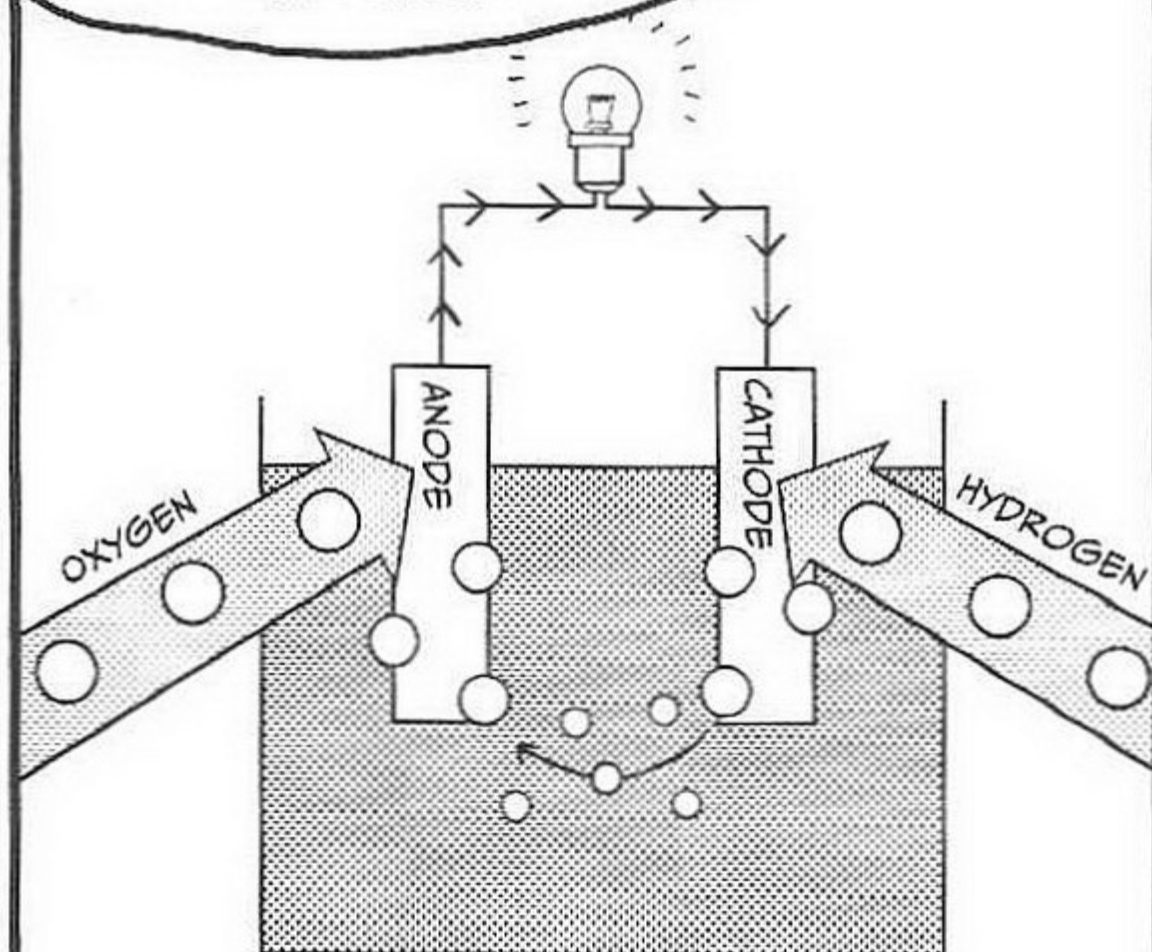

THAT'S AMAZING!

THEREFORE, HYDROGEN AND OXYGEN ARE SUPPLIED IN A FUEL CELL TO CREATE ELECTRICITY.

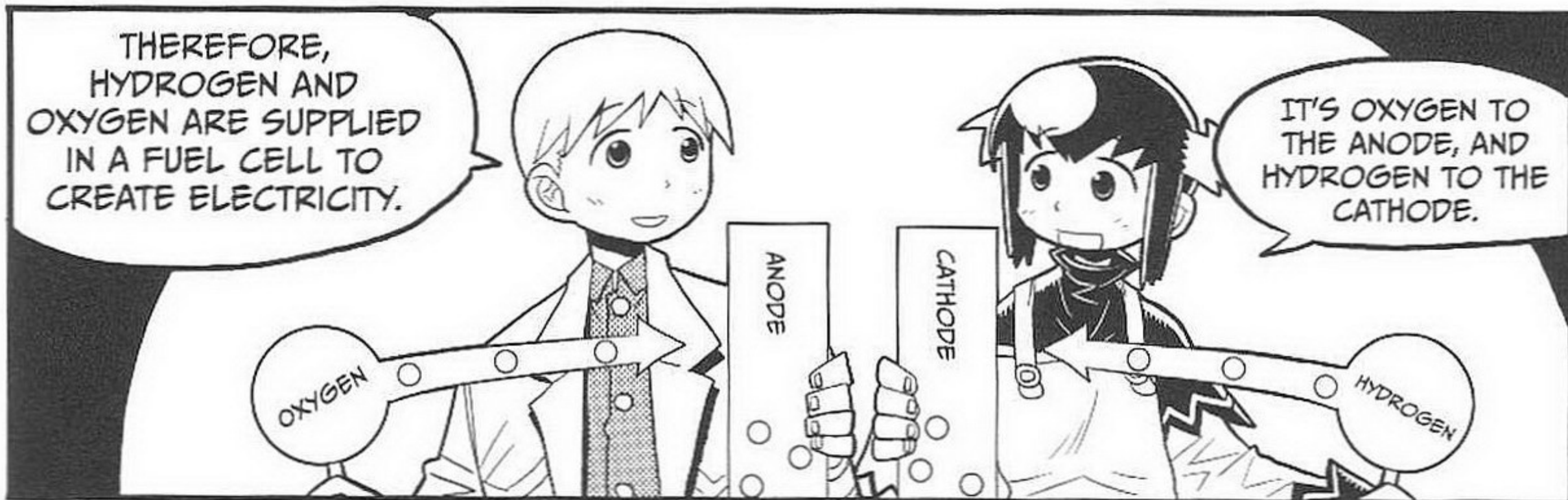

IT'S OXYGEN TO THE ANODE, AND HYDROGEN TO THE CATHODE.

THE SUPPLIED HYDROGEN...

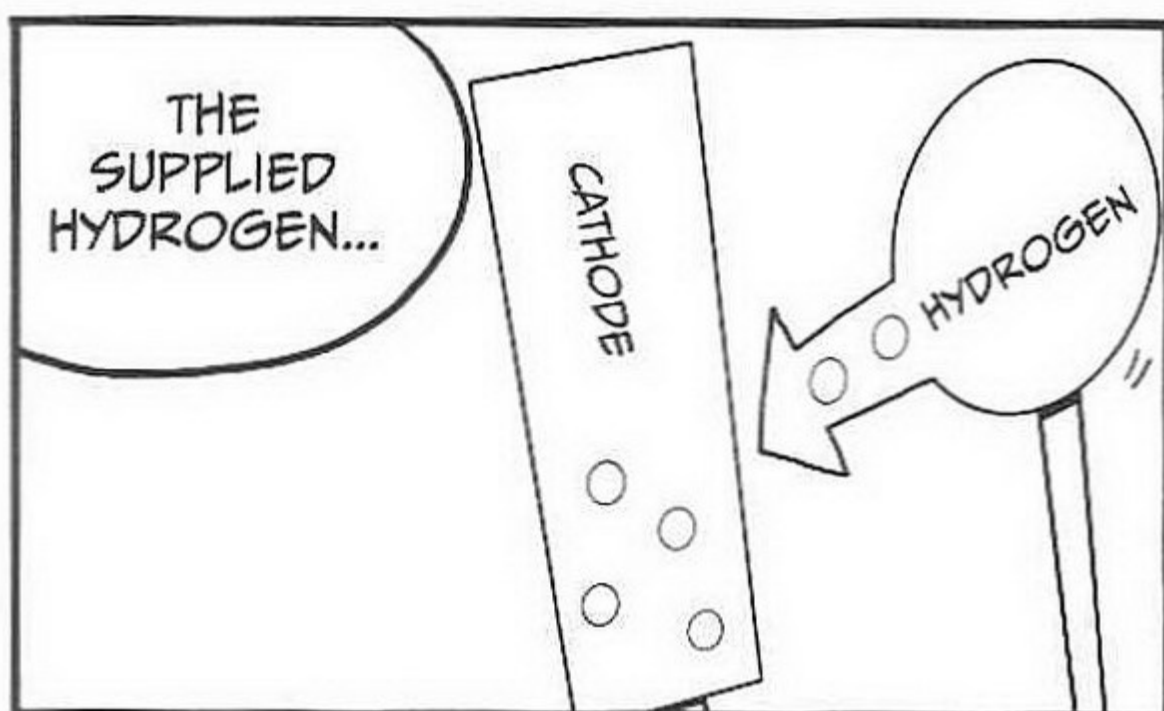

...IS SEPARATED INTO A HYDROGEN ION AND AN ELECTRON BY THE CATALYST OF THE CATHODE.

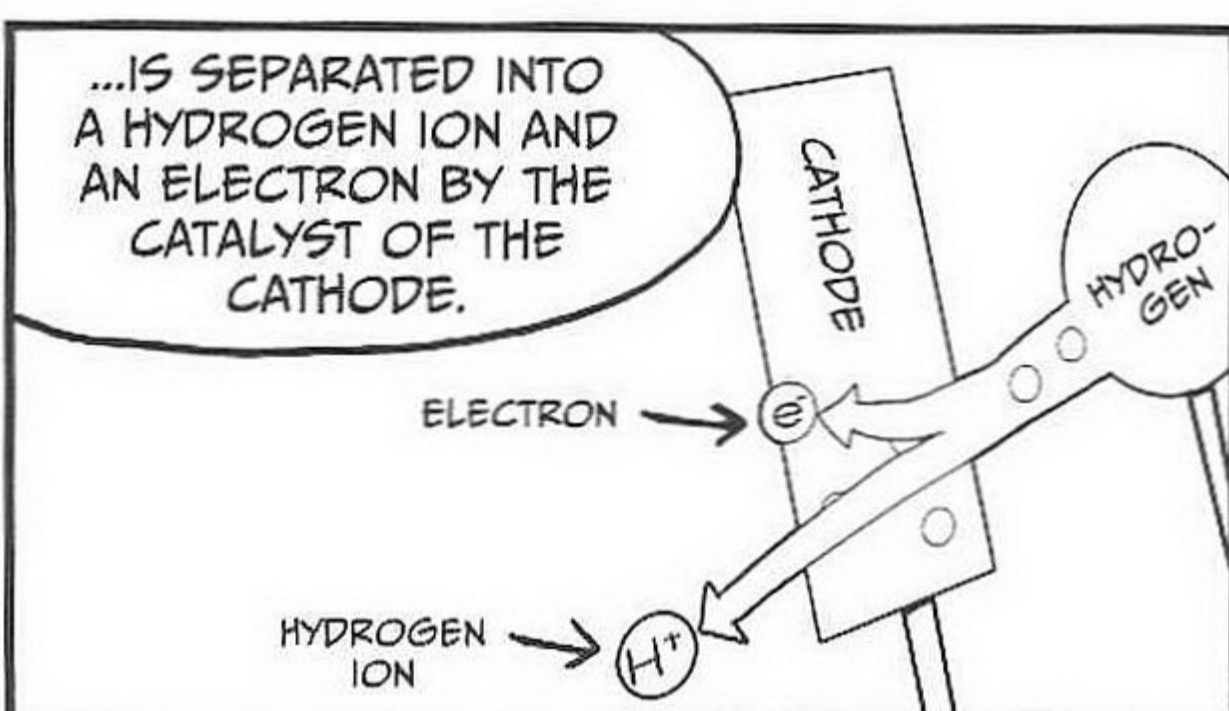

ANODES AND CATHODES

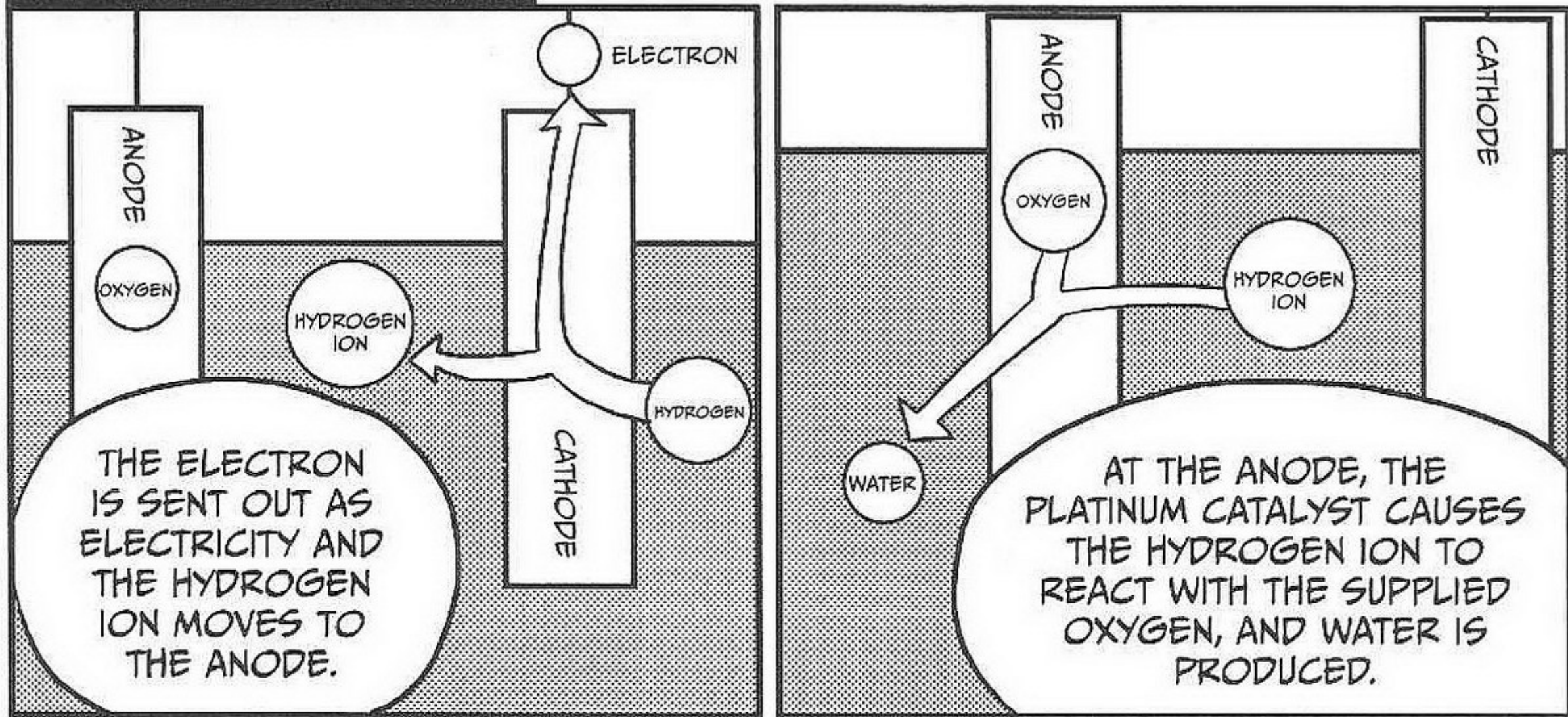

THE ELECTRON IS SENT OUT AS ELECTRICITY AND THE HYDROGEN ION MOVES TO THE ANODE.

AT THE ANODE, THE PLATINUM CATALYST CAUSES THE HYDROGEN ION TO REACT WITH THE SUPPLIED OXYGEN, AND WATER IS PRODUCED.

MECHANISM OF A FUEL CELL

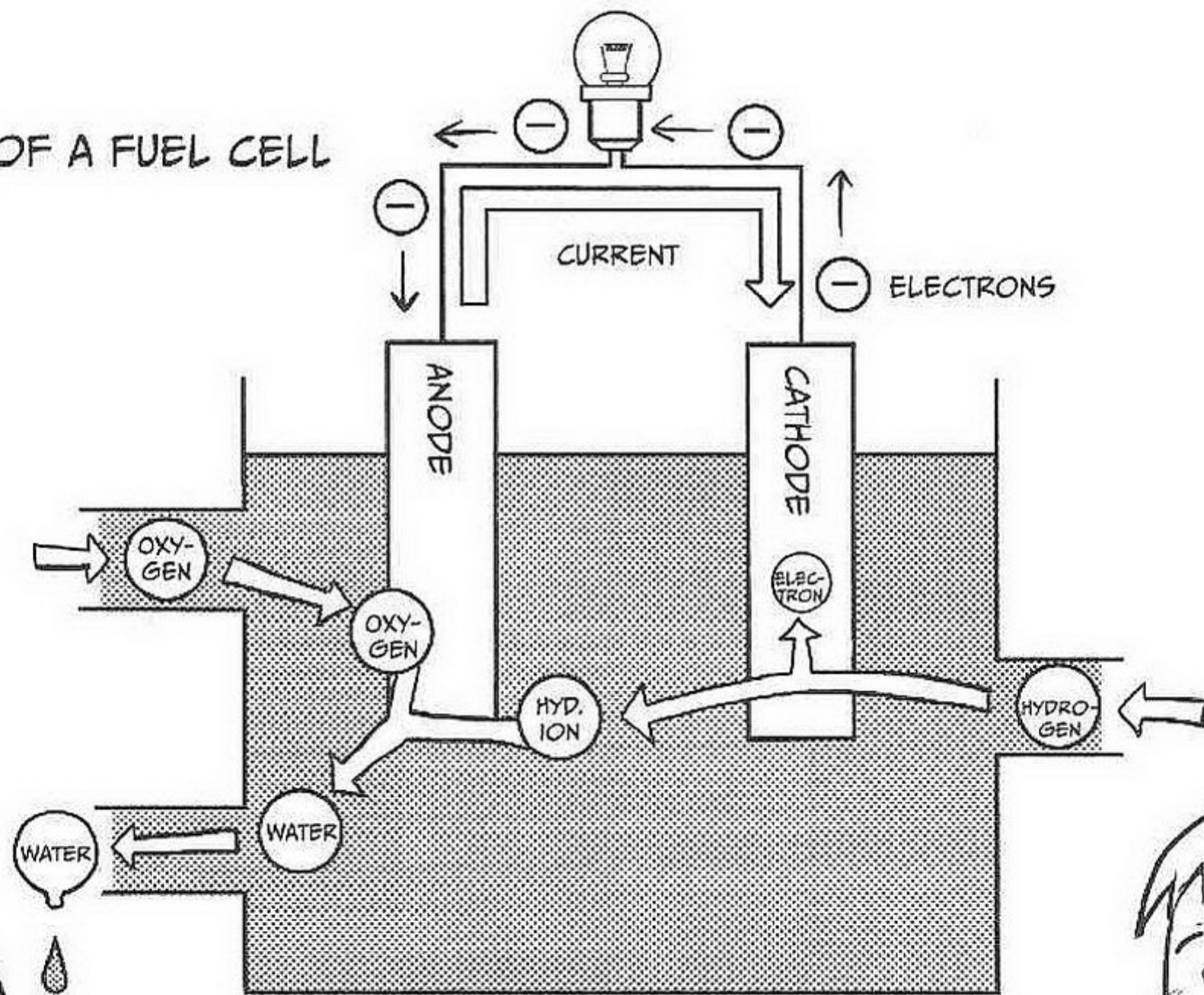

IF ONLY WATER IS EMITTED AFTER THE ELECTRICITY IS CREATED, IT ALSO SEEMS TO BE GOOD FOR THE ENVIRONMENT, RIGHT?

YUP.



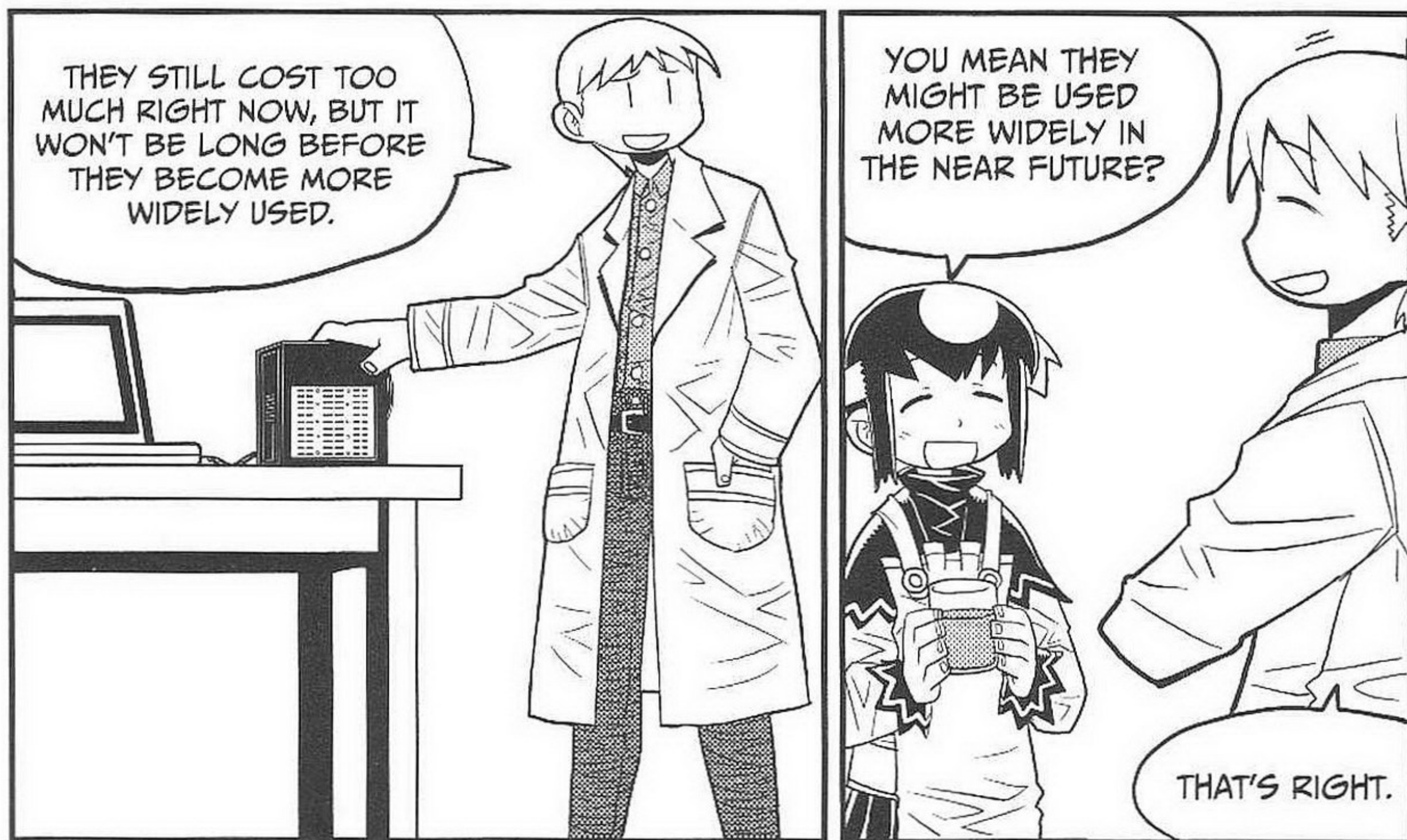

CREATING YOUR OWN COIN BATTERY

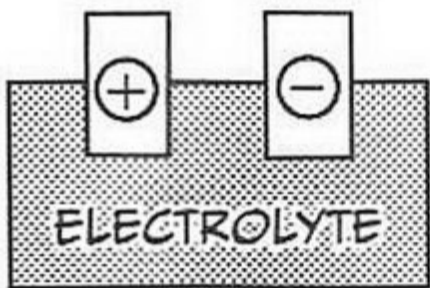

ONCE WE KNOW ABOUT THE CHEMICAL REACTION THAT A BATTERY USES, IT'S SIMPLE TO CREATE ONE OF OUR OWN.

IS THAT RIGHT?

ALL WE NEED IS TWO TYPES OF METAL AND AN ELECTROLYTE. WE CAN EVEN USE COMMON ITEMS THAT ARE CLOSE AT HAND.



FOR EXAMPLE...

...ALL WE NEED IS THIS STUFF!

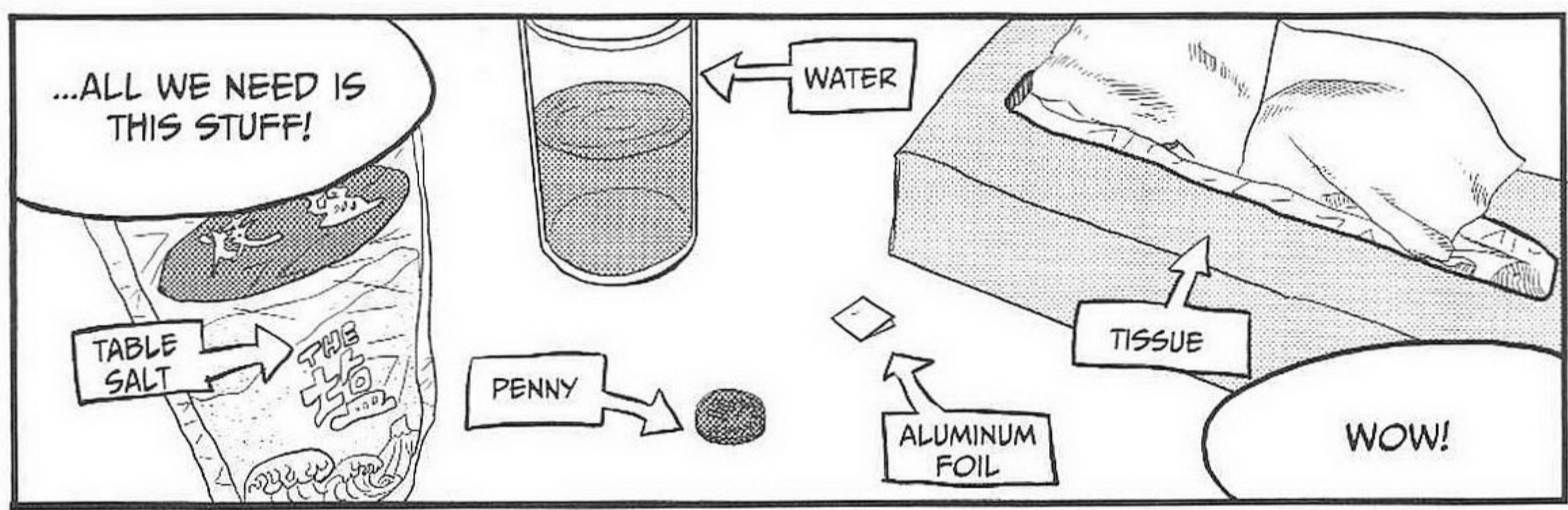

TABLE SALT

WATER

PENNY

ALUMINUM FOIL

TISSUE

WOW!

IF WE JUST USE A PENNY (COPPER) FOR THE POSITIVE POLE, A FOLDED PIECE OF ALUMINUM FOIL FOR THE NEGATIVE POLE, AND INSERT A TISSUE THAT WAS SOAKED IN SALT WATER AS THE ELECTROLYTE BETWEEN THEM, WE HAVE A BATTERY!

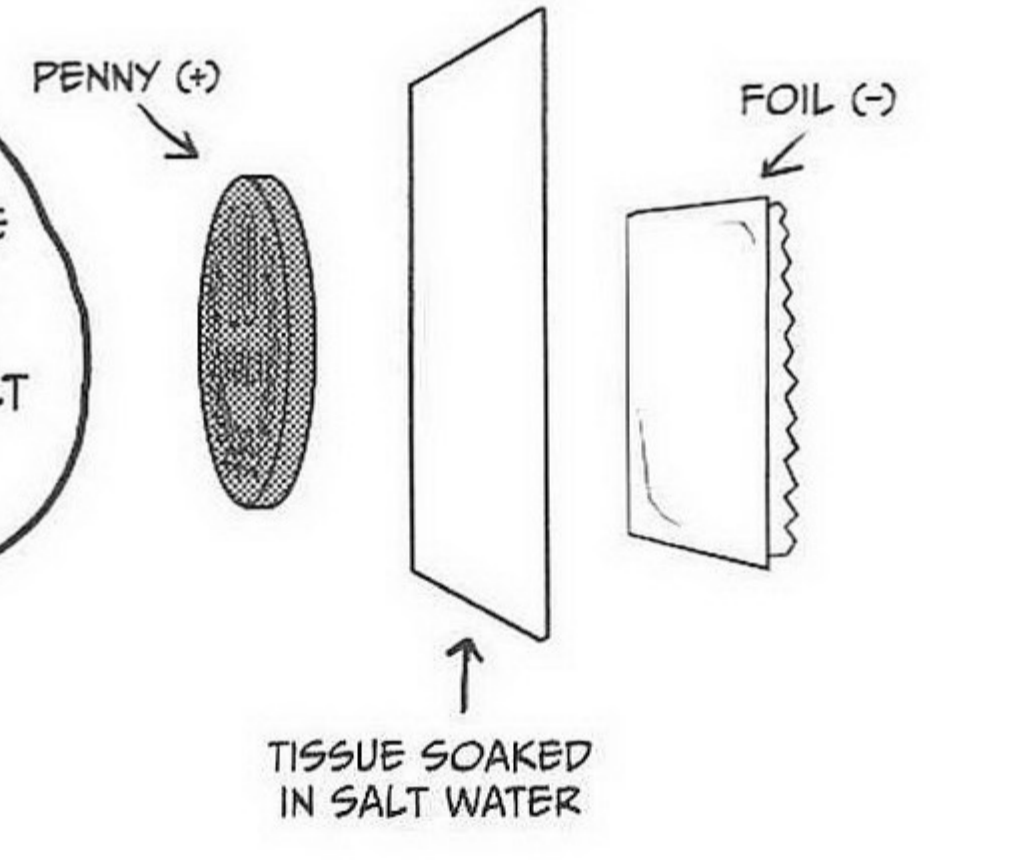

PENNY (+)

FOIL (-)

TISSUE SOAKED IN SALT WATER

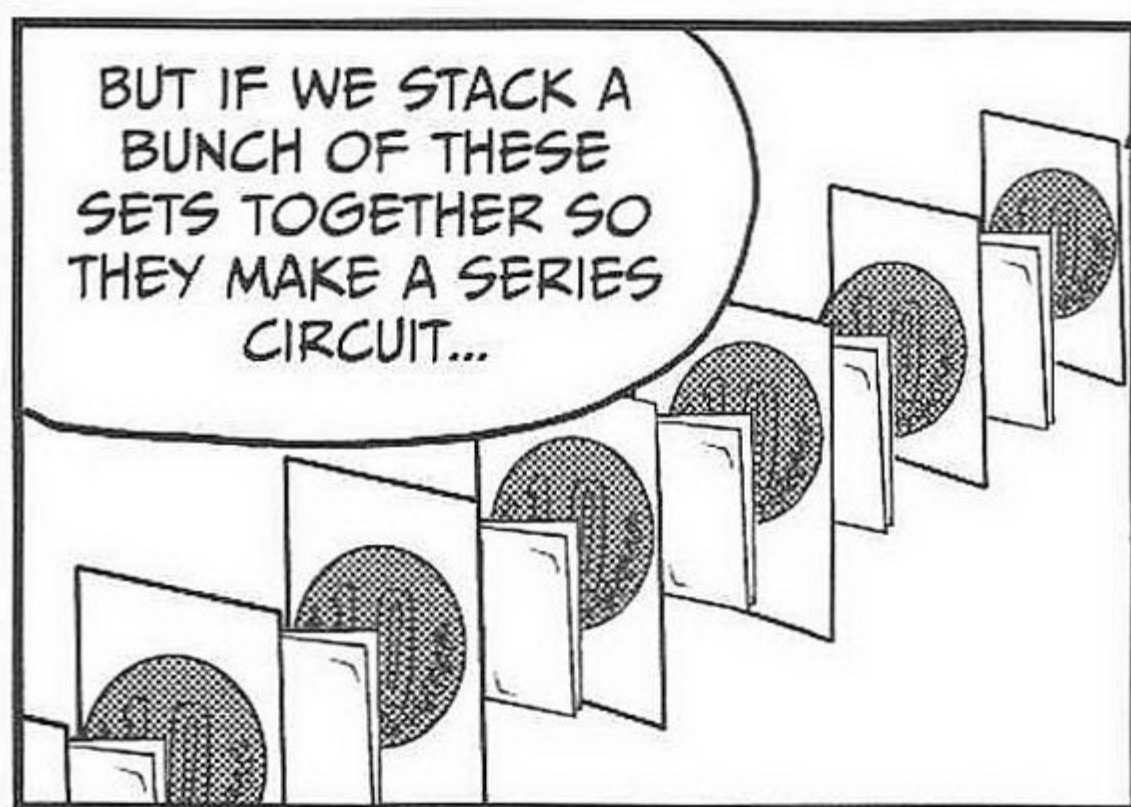
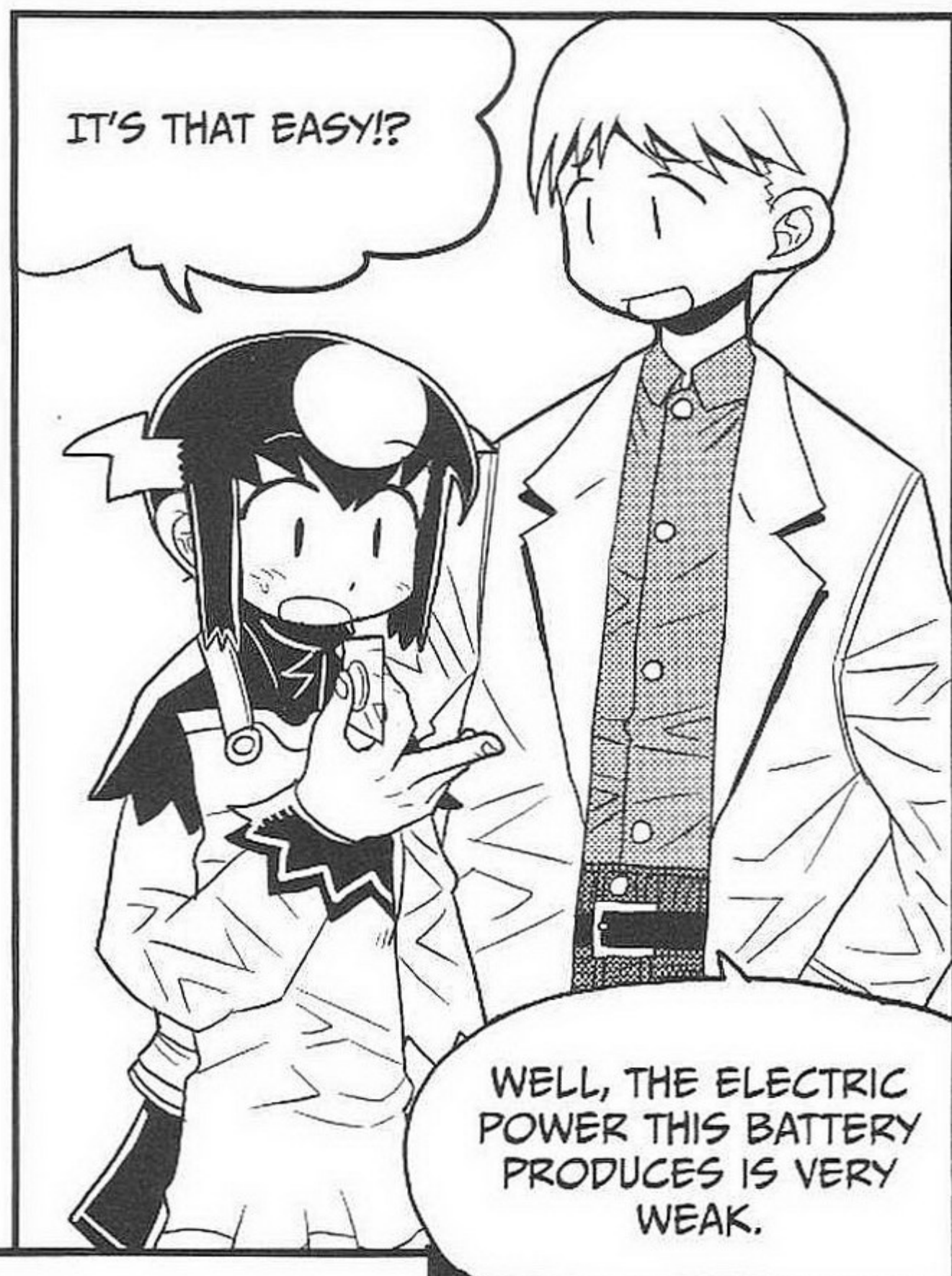

THERMOPILES



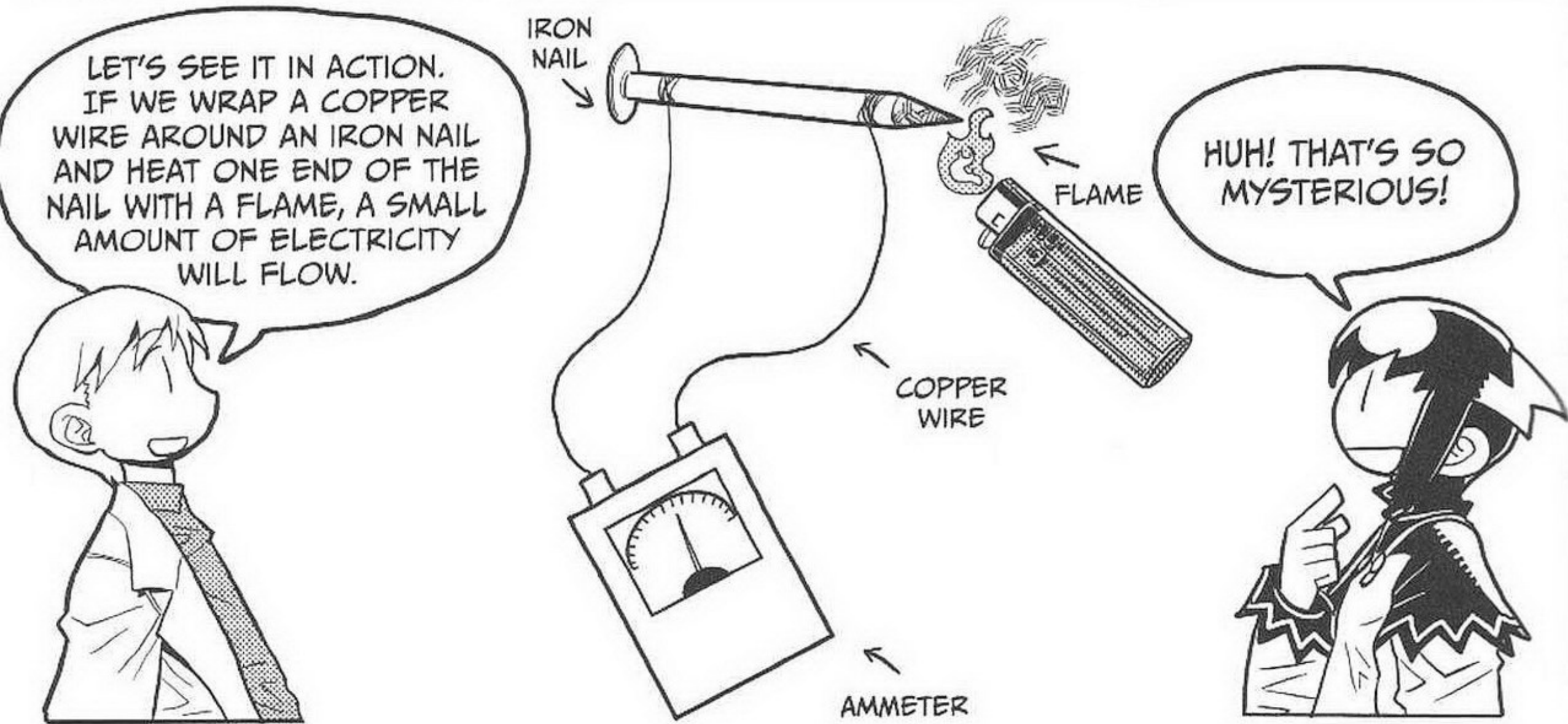
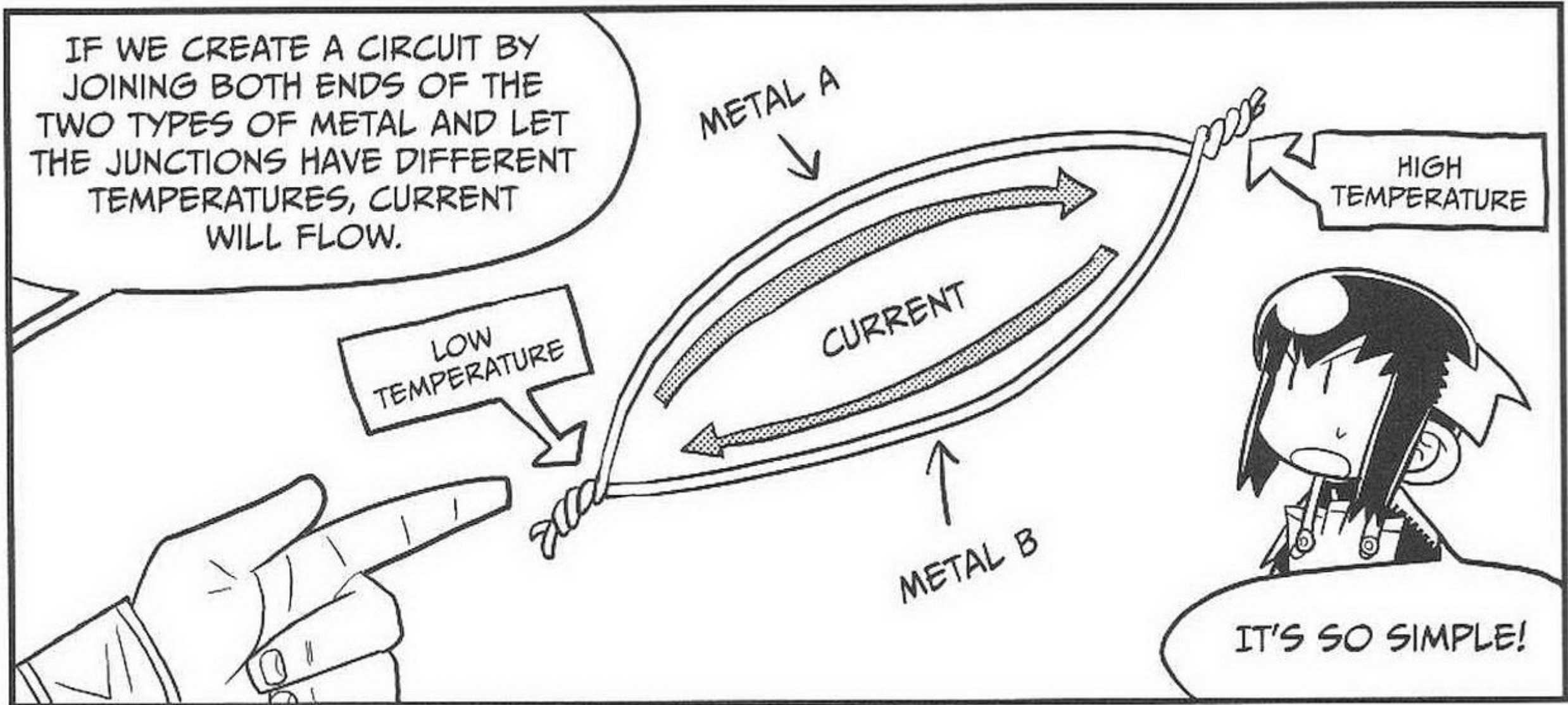

THE GREATER THE TEMPERATURE DIFFERENCE BETWEEN THE JUNCTIONS, THE GREATER THE CURRENT THAT WILL FLOW. CURRENT WILL CONTINUE TO FLOW AS LONG AS THERE IS A TEMPERATURE DIFFERENCE.

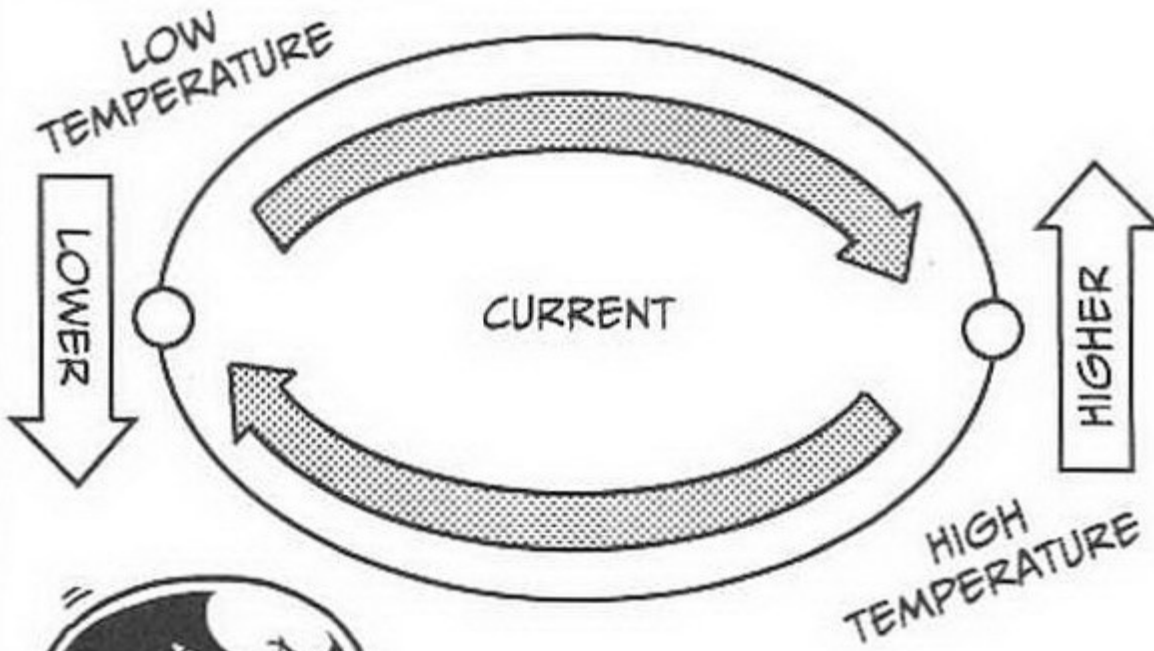

AHA!

THE JUNCTIONS OF THESE TWO TYPES OF METALS ARE CALLED THERMOCOUPLES.



IF THIS IS COMBINED WITH AN AMMETER, IT CAN ALSO BE USED AS A THERMOMETER.

AN AMMETER MEASURES CURRENT IN A CIRCUIT.



COOL!

THAT'S BECAUSE WE CAN TELL THE TEMPERATURE APPLIED TO THE THERMOCOUPLE BY CHECKING THE AMOUNT OF CURRENT, RIGHT?



EXACTLY!

THERE IS ALSO A PHENOMENON THAT IS THE REVERSE OF THE SEEBECK EFFECT. IF A DC CURRENT IS CONNECTED TO THE THERMOCOUPLES AND CURRENT FLOWS, THE THERMOCOUPLE AT ONE SIDE WILL ABSORB HEAT AND THE OTHER ONE WILL GENERATE HEAT.

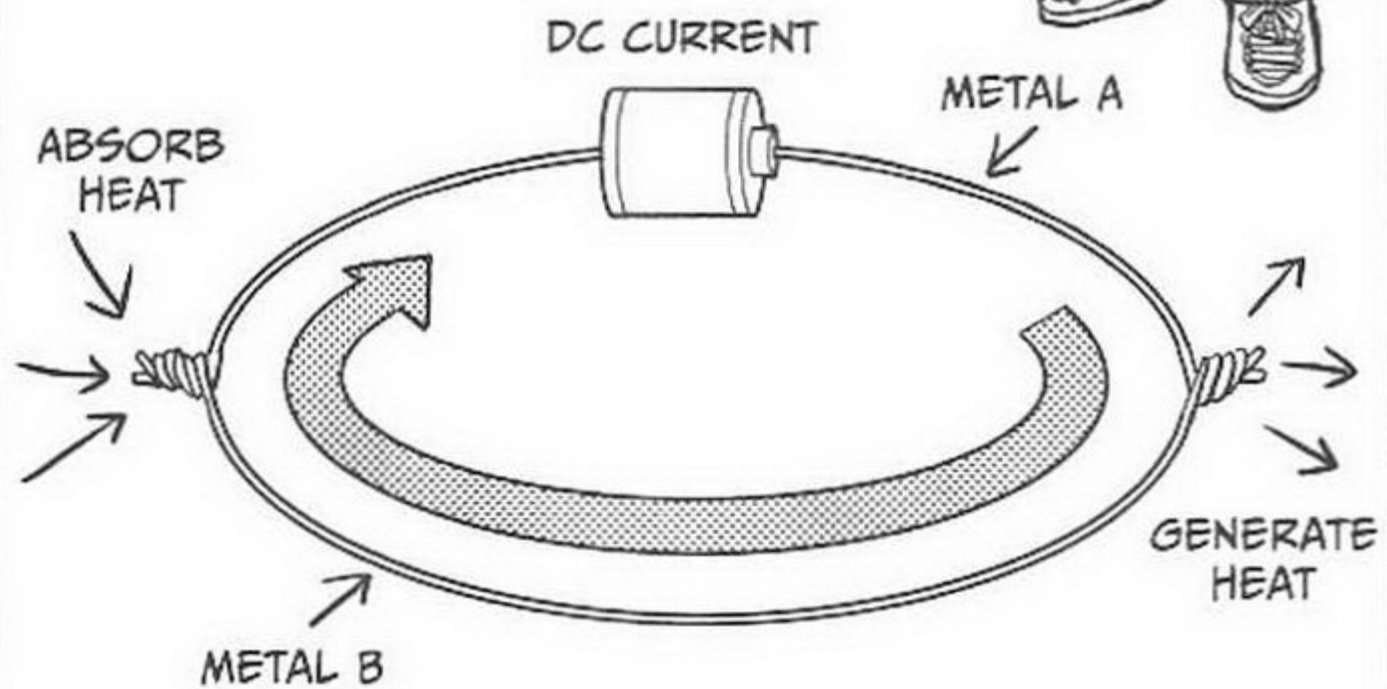

WOW...SO WE SHOULD BE ABLE TO APPLY THIS TO WARM AND COOL OBJECTS, RIGHT?

RIGHT! THIS IS CALLED THE PELTIER EFFECT.

THE HEAT-ABSORBING SIDE OF A PELTIER DEVICE, WHICH IS A SEMICONDUCTOR DEVICE, IS USED IN AN APPLIANCE SUCH AS A SMALL REFRIGERATOR THAT DOES NOT NEED A MOTOR.

PHENOMENA SUCH AS THE SEEBECK EFFECT OR PELTIER EFFECT ARE COLLECTIVELY KNOWN AS THERMOELECTRIC PHENOMENA.

THANKS... THAT'S ALL FOR TODAY.

ALL RIGHT. I REALLY LEARNED A LOT!

♪ RING, RING ♪

AH! TETEKU SENSEI IS CALLING.

RING, RING



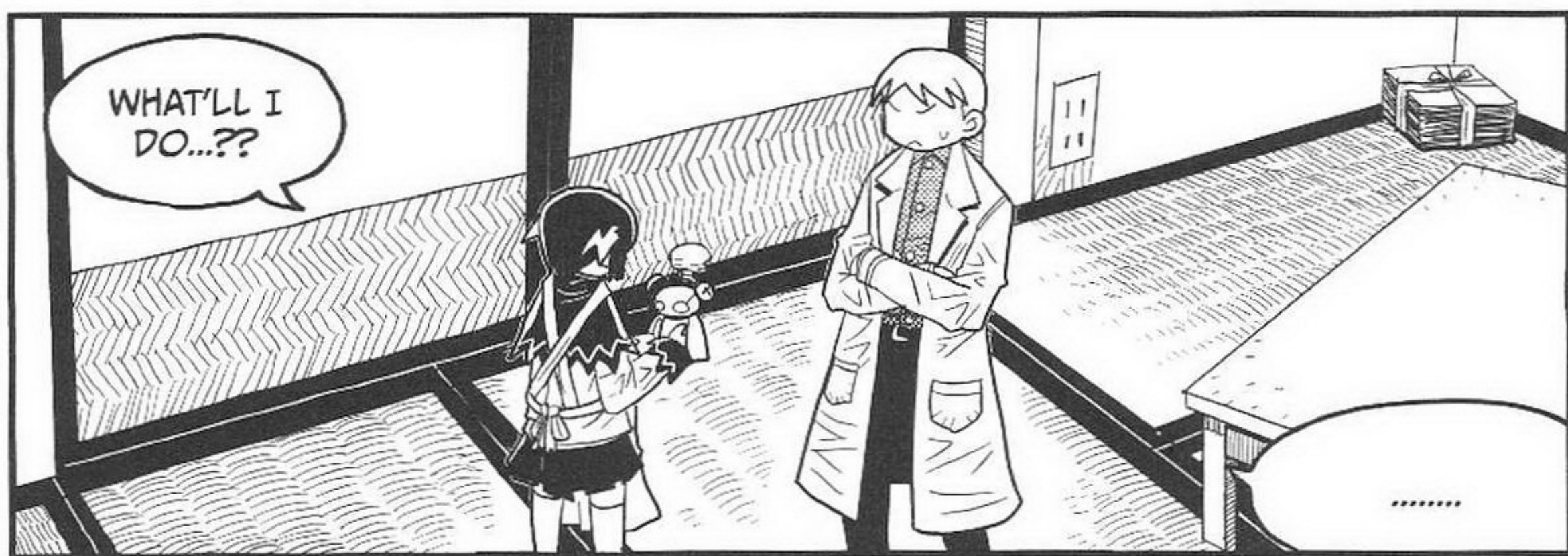
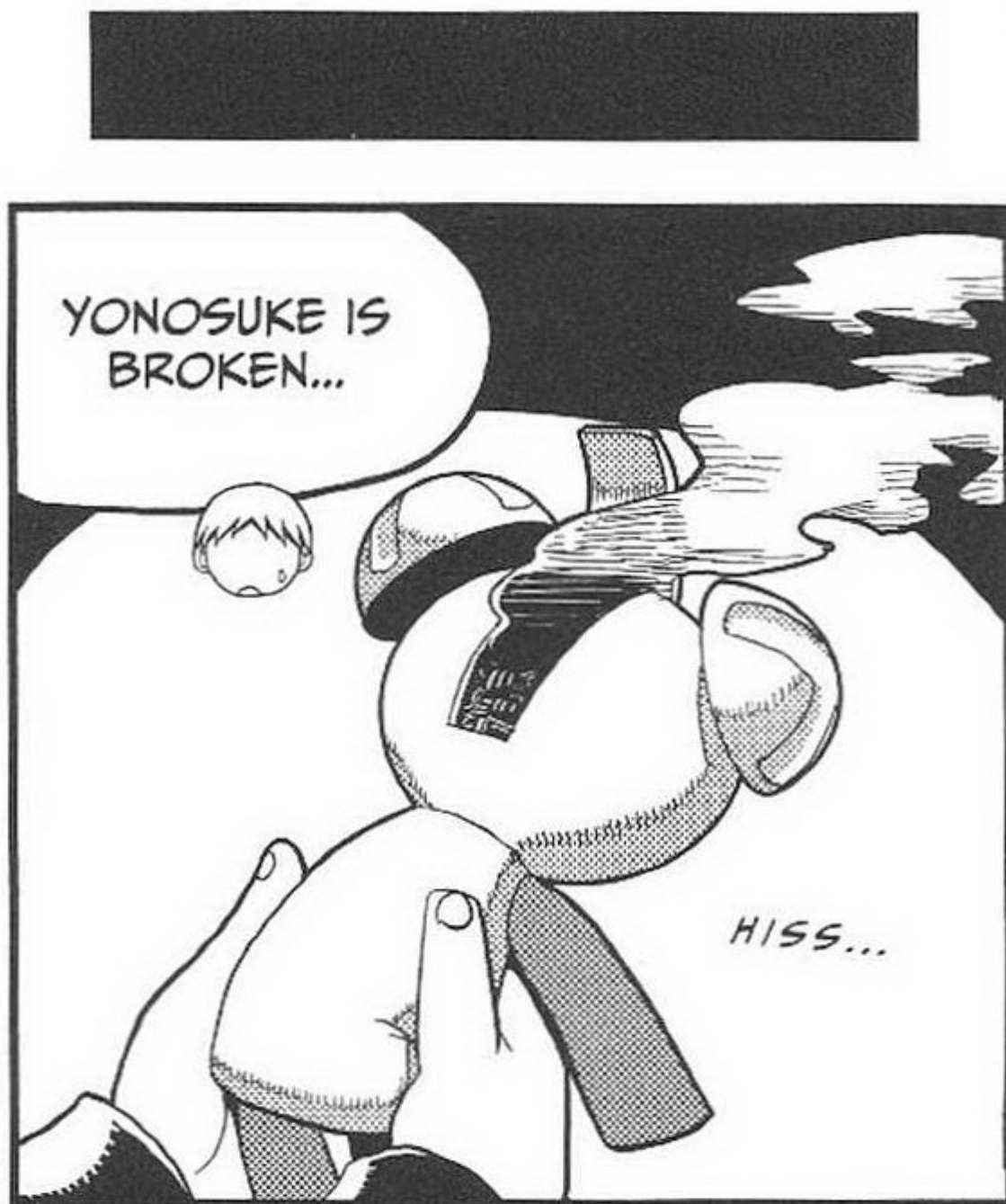

ELECTRICITY CREATED BY A POWER PLANT

In power plants, no matter what the source of motion, a turbine spins, which generates electricity in a generator.

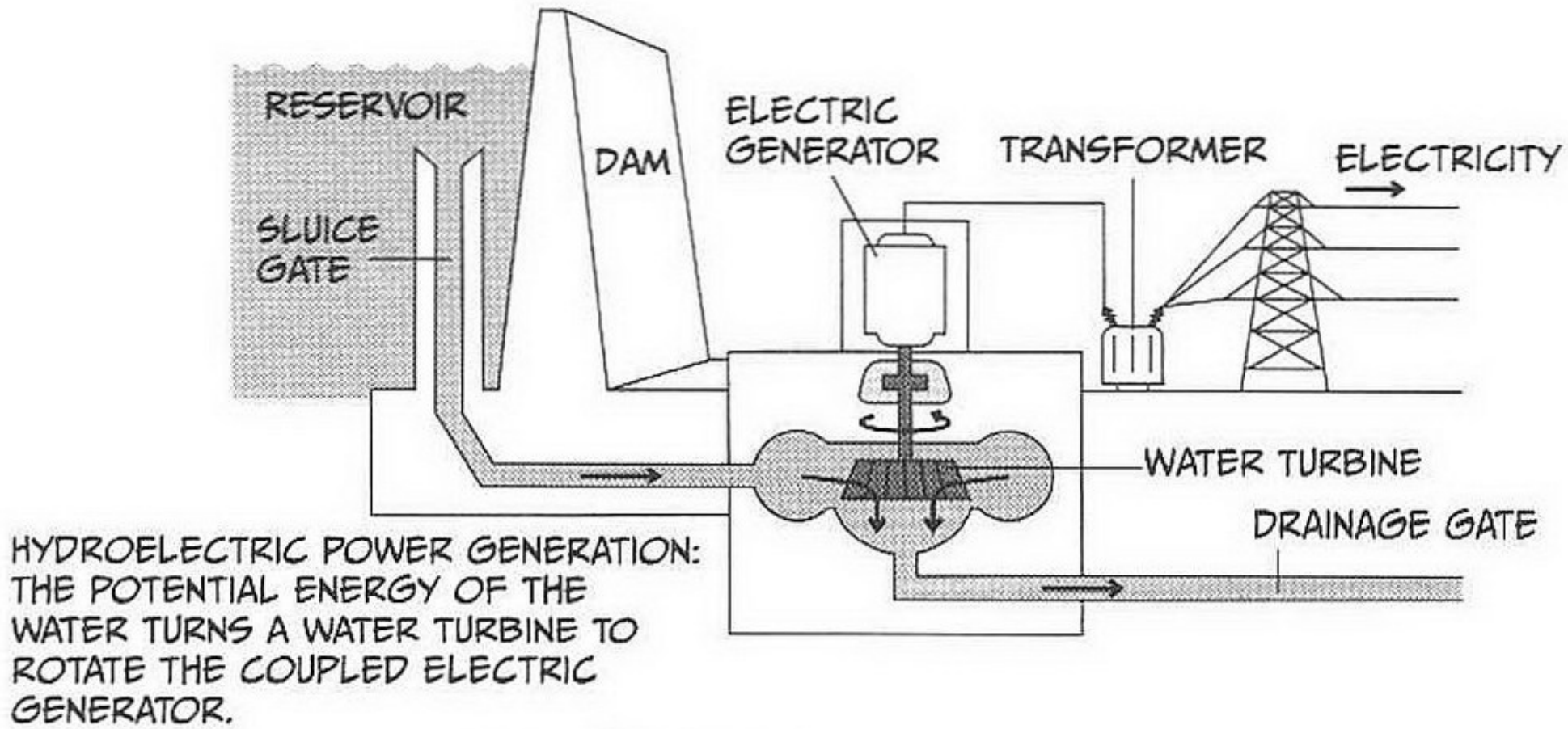

HYDROELECTRIC POWER GENERATION: THE POTENTIAL ENERGY OF THE WATER TURNS A WATER TURBINE TO ROTATE THE COUPLED ELECTRIC GENERATOR.

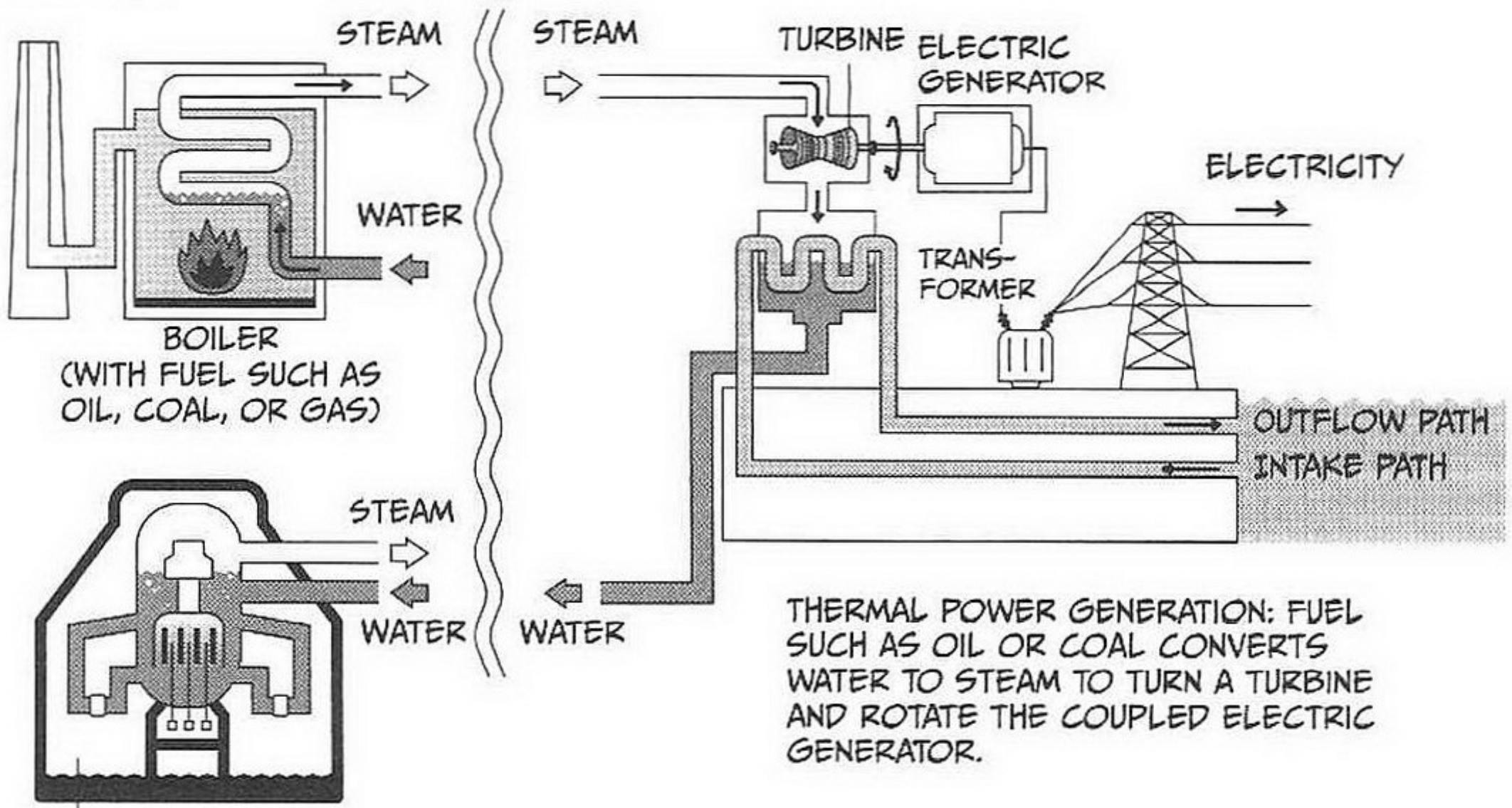

THERMAL POWER GENERATION: FUEL SUCH AS OIL OR COAL CONVERTS WATER TO STEAM TO TURN A TURBINE AND ROTATE THE COUPLED ELECTRIC GENERATOR.

NUCLEAR POWER GENERATION: THE HEAT THAT IS GENERATED WHEN NUCLEAR MATERIAL UNDERGOES NUCLEAR FISSION CONVERTS WATER TO STEAM TO TURN A TURBINE AND ROTATE THE COUPLED ELECTRIC GENERATOR.

An electric generator creates electricity according to Fleming's right-hand rule. And since the conductor is rotating within the magnetic field, both the magnitude and direction of the electricity's flow vary repeatedly like a wave. The maximum voltage is generated when the loop of wire cuts through the magnetic field at a right angle, and the voltage is zero when the direction of the magnetic field and the direction of the loop's movement are the same.

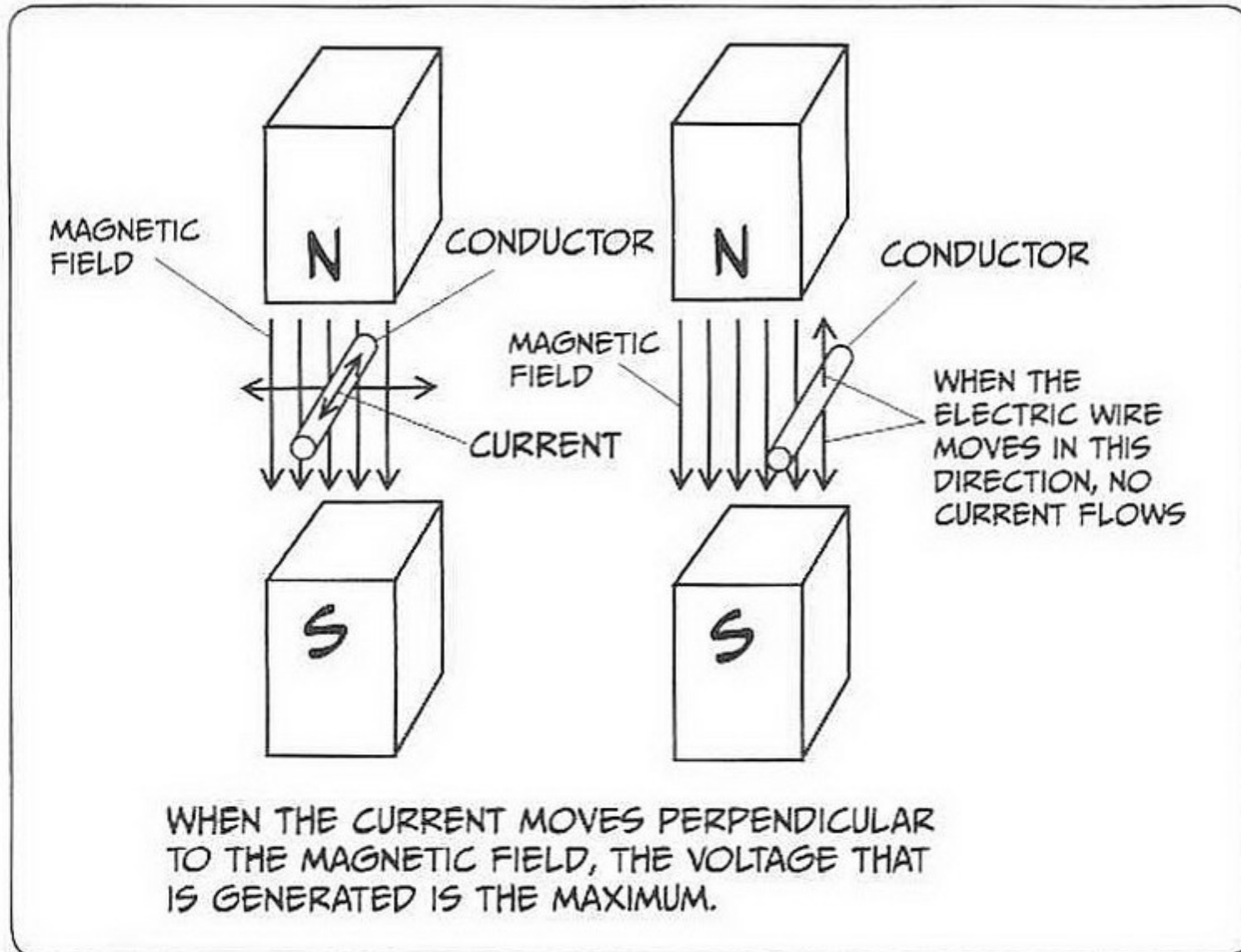

Electricity generated in a conductor

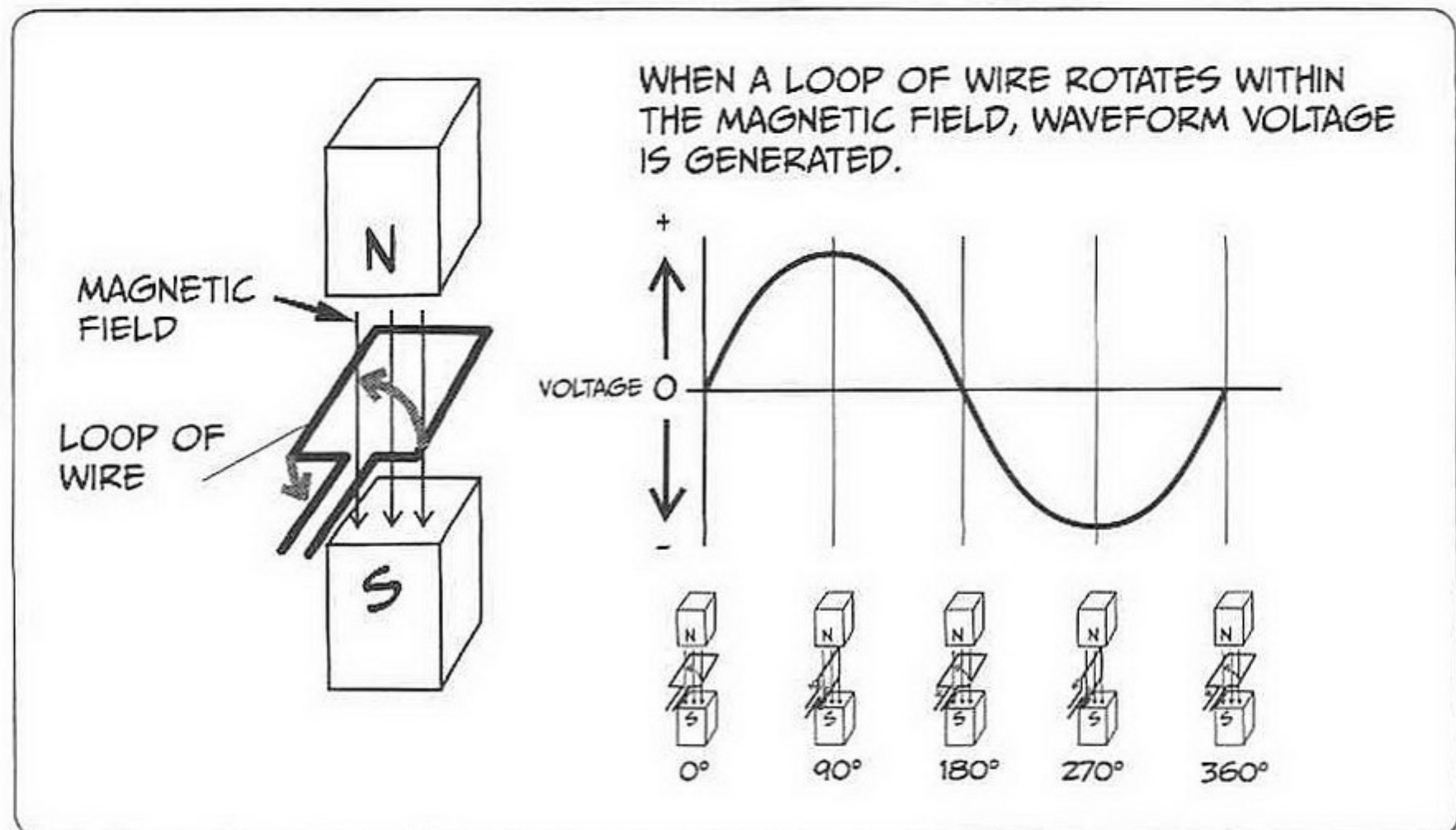

Electricity created by an electric generator

The electricity that is created by this process is called *alternating current (AC)*. This is the electricity that comes from a household electric outlet. One wave is created by one rotation of the conductor within the magnetic field. If the conductor rotates 60 times per second, 60 waves are produced per second. This would be electricity with a frequency of 60 hertz (Hz).

The voltage of an ordinary household electric outlet is 120V AC. The *peak voltage* of the wave of this electricity is approximately 170V. The value of 120V represents the *effective voltage*, which is the value for which direct current (DC) electricity does the same work—in other words, the amount of heat generated when 120V AC is applied to a resistance is the same as the amount of heat generated when 120V DC is applied to the same resistance.

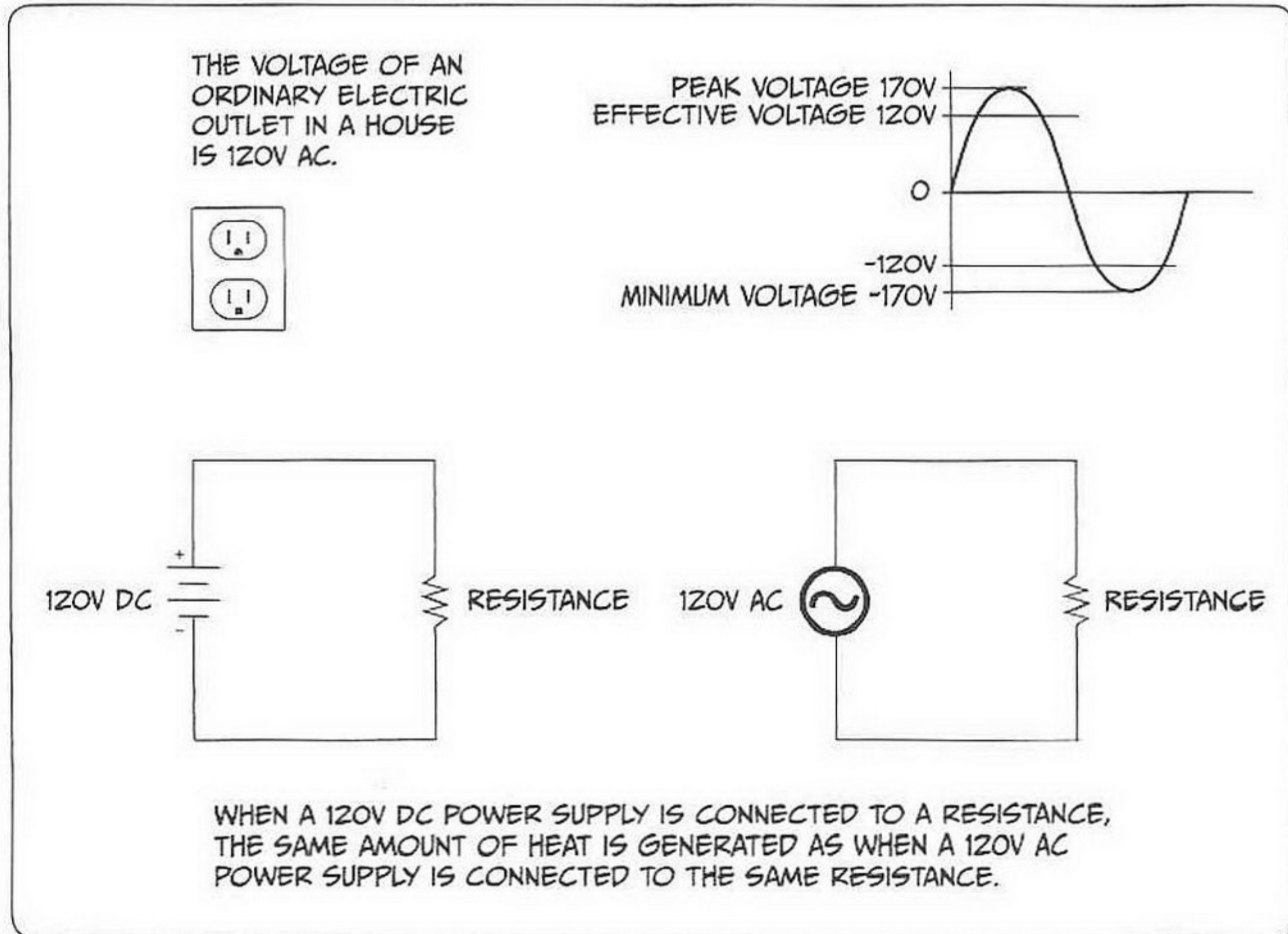

AC voltage and effective voltage

THERMAL POWER GENERATION

The types of thermal power generation that generate the most electrical power are steam generation, internal combustion generation, gas turbine generation, and combined cycle generation.

Steam generation burns fuel such as oil, coal, or liquefied natural gas (LNG) in a boiler to generate high-temperature, high-pressure steam. The force of that steam turns a turbine that is coupled with an electric generator to generate electricity.

The steam that was used to generate electricity is cooled in a device called a *condenser*; once it returns to liquid water, it is then sent to the boiler again.

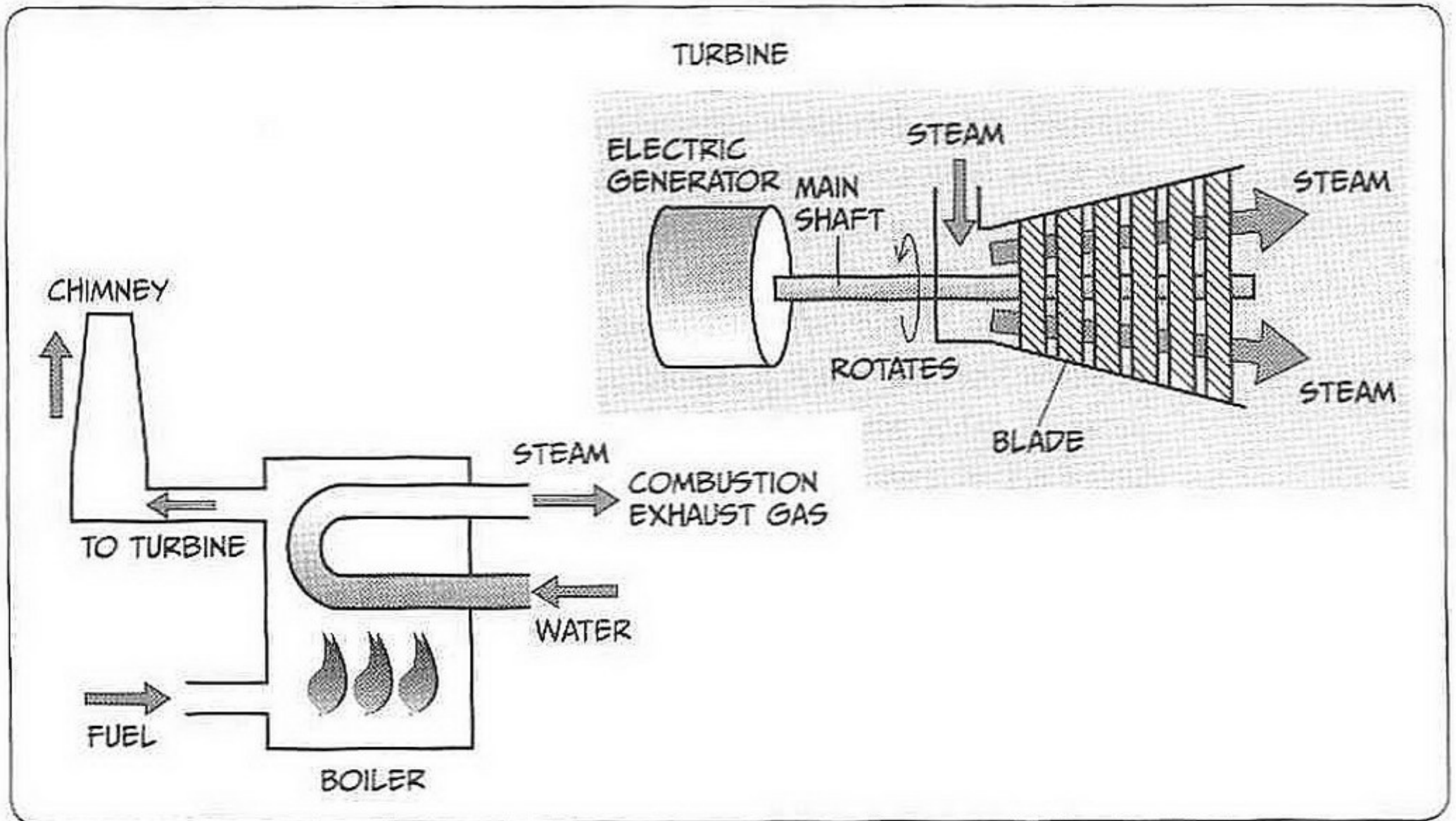

Turbine and steam power generation

Internal combustion generation uses an internal combustion engine (like a diesel engine) to generate electricity.

Gas turbine generation uses a combustion gas such as kerosene or diesel oil to turn a gas turbine and create electricity.

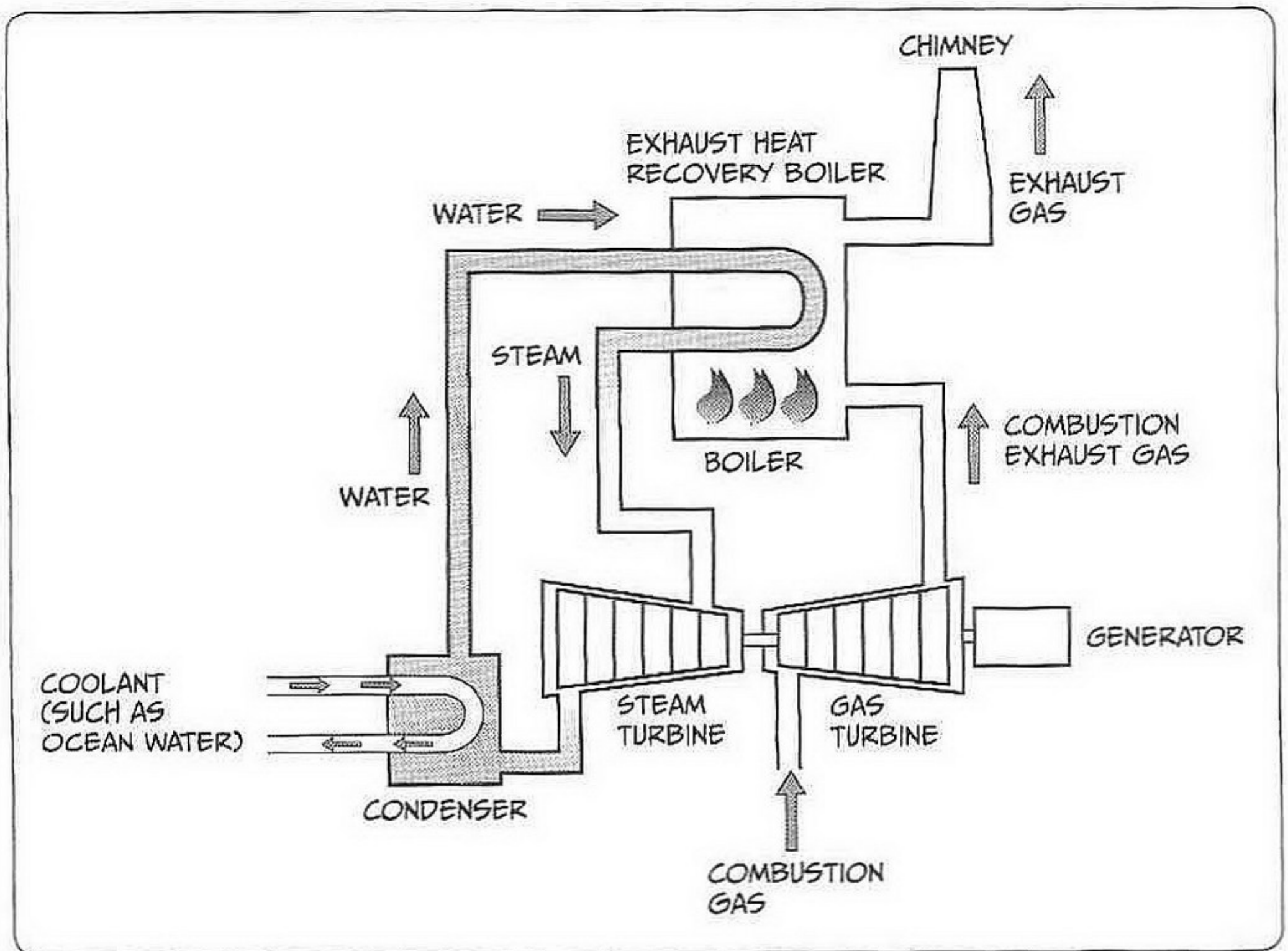

Combined cycle generation

Combined cycle generation combines steam generation and gas turbine generation. Electricity is generated by a gas turbine, and then the heat of the exhaust gas is used to create steam to turn a steam turbine and generate more electricity; this is an efficient method of generating electricity.

NUCLEAR POWER GENERATION

Nuclear power generation uses the heat generated when the nuclear fission of uranium occurs in a nuclear reactor to create high-temperature, high-pressure steam, which turns a turbine and creates electricity. When a neutron collides with uranium-235, it decays to thorium-231; several neutrons as well as heat are emitted. The neutrons successively collide with other uranium-235 nuclei, causing *nuclear fission* to occur and generating a great deal of thermal energy.

Nuclear power generation uses this heat to create steam, which turns a turbine and generates electricity in a manner similar to thermal power generation. *Control rods*, which absorb neutrons, and a *moderator*, which reduces the speed of the neutrons, are used in the nuclear reactor to control nuclear fission and regulate the reactor's output.

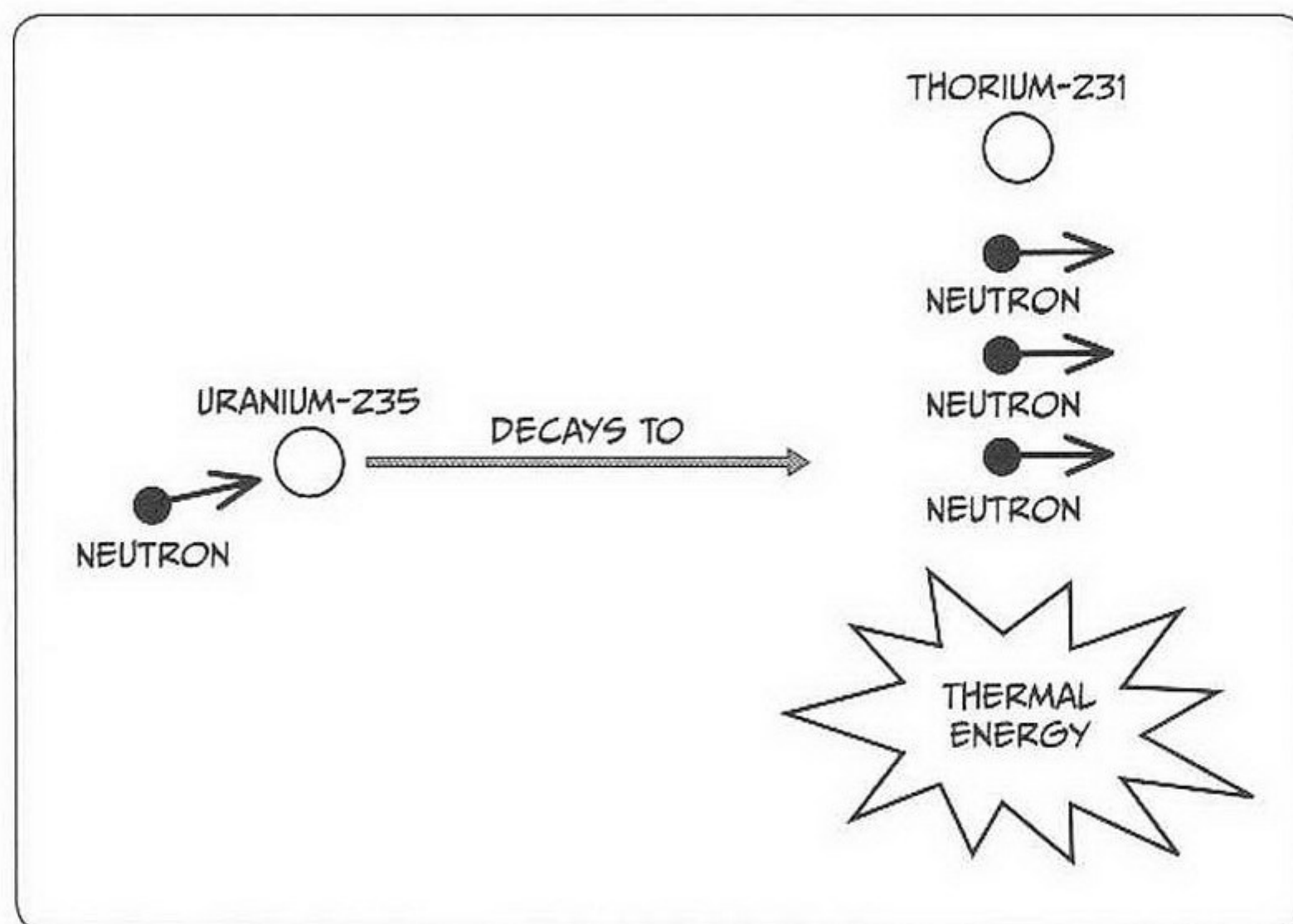

The nuclear fission of uranium-235 leads to more neutrons, which may strike other U-235 atoms, causing a chain reaction.

There are various types of nuclear reactors. Currently, the type that is used most often is called a *light water reactor*, which uses light water (ordinary water) as a moderator and coolant. Light water reactors include boiling water reactors and pressurized water reactors.

A *boiling water reactor* sends steam that was generated in the reactor pressure vessel directly to the turbine; after it turns the turbine, the steam turns back into liquid water in a device called a condenser, and the water is reused. A *condenser* uses ocean water to cool the steam so it turns back into liquid water and can be reused.

A *pressurized water reactor* passes boiling water that was created in the reactor pressure vessel to the steam generator, where water from a separate system is changed to steam, which turns the turbine.

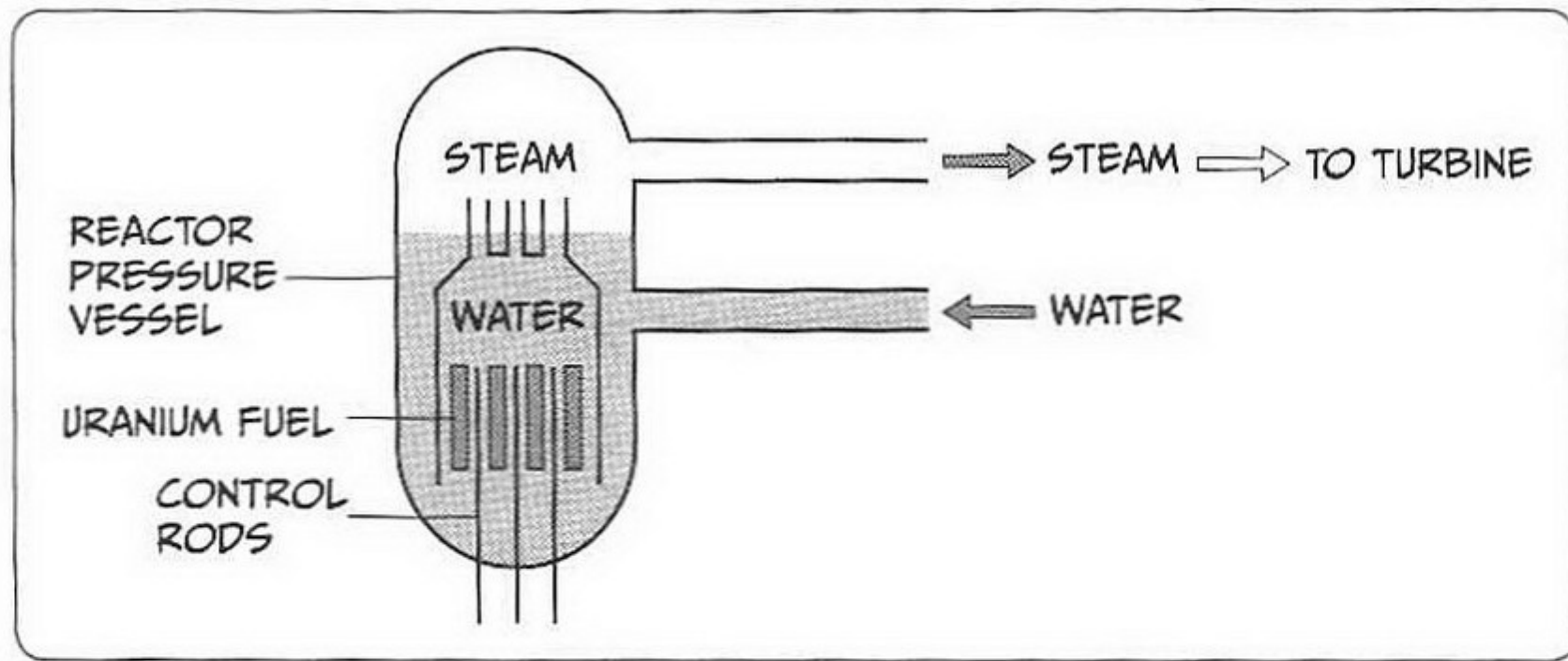

Boiling water reactor

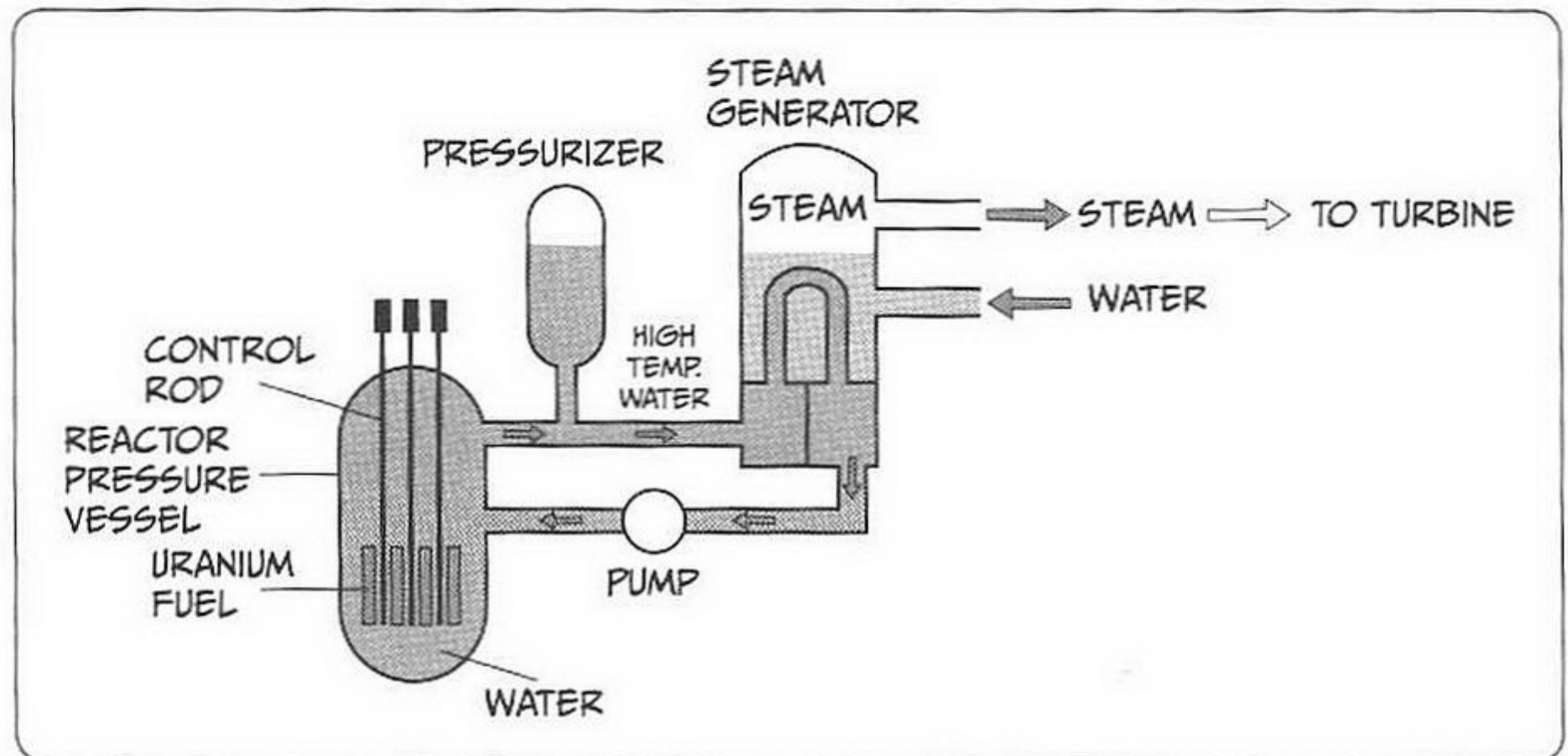

Pressurized water reactor

HYDROELECTRIC POWER GENERATION

Hydroelectric power generation uses the potential energy of water to generate electricity. Dam-type power generation stores water at a high location and lets the water drop from there to turn a water turbine coupled with an electric generator to generate electricity.

Since it is easier to start and stop power generation and to increase or decrease the amount of power generated via hydroelectric power generation than it is to do so for thermal or nuclear power generation, hydroelectric power can be generated corresponding to varying power demands. Also, during periods of low power demand, a lift pump can be used to draw water up to the higher location to store it as potential energy.

For hydroelectric power generation to use the energy of water efficiently, several types of water turbines are used for different purposes according to the *head* (height difference) or amount of water.

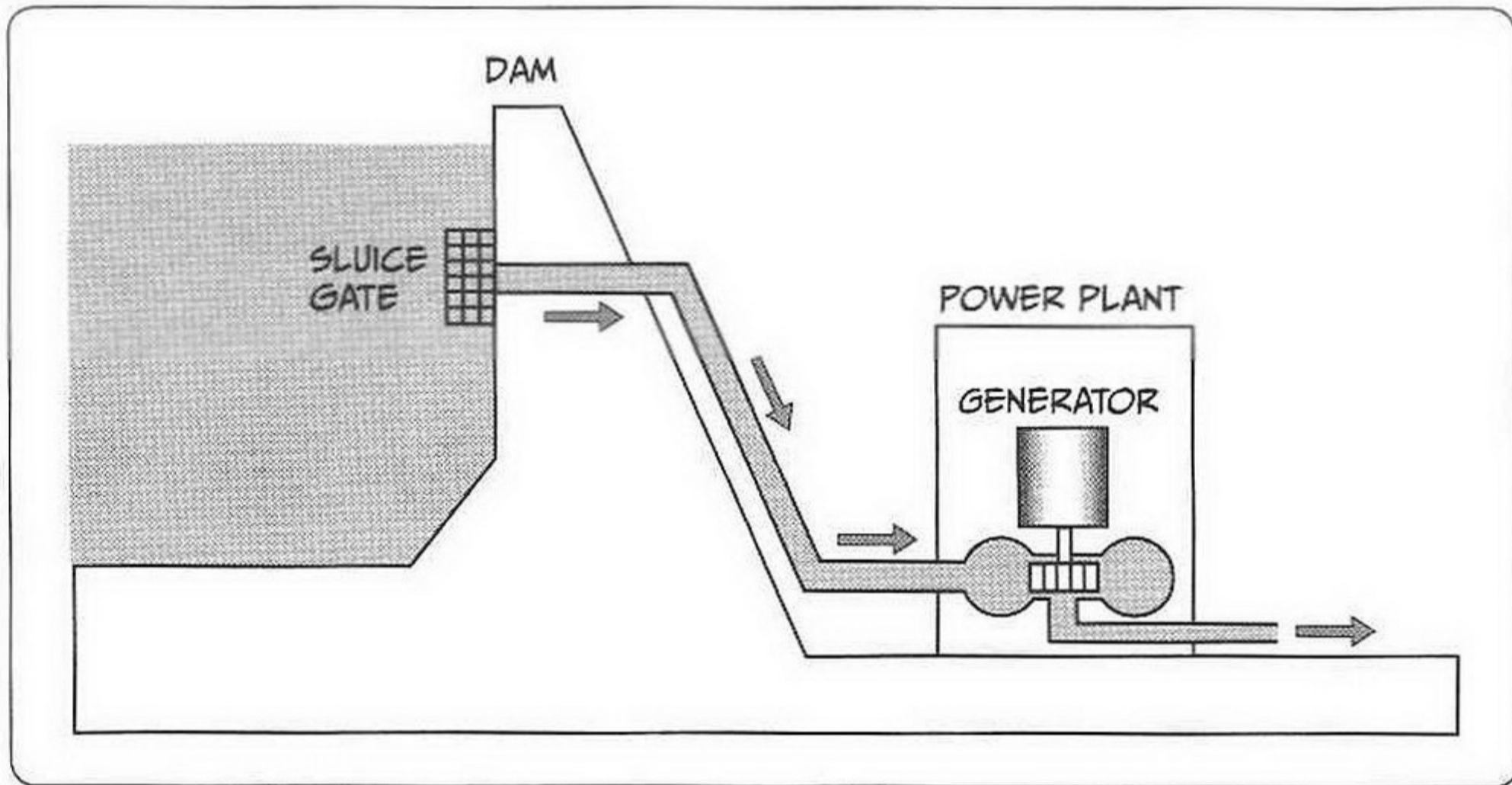

Dam-type power plant

A *Francis turbine* is used for a large amount of running water and a medium to high head. This type of water turbine is used for approximately 70 percent of the hydroelectric power generation in Japan. The water is directed perpendicular to the main shaft from all directions, the blades inside the turbine change the water's direction to the axial direction, and the turbine is rotated by hydraulic power when the water is discharged.

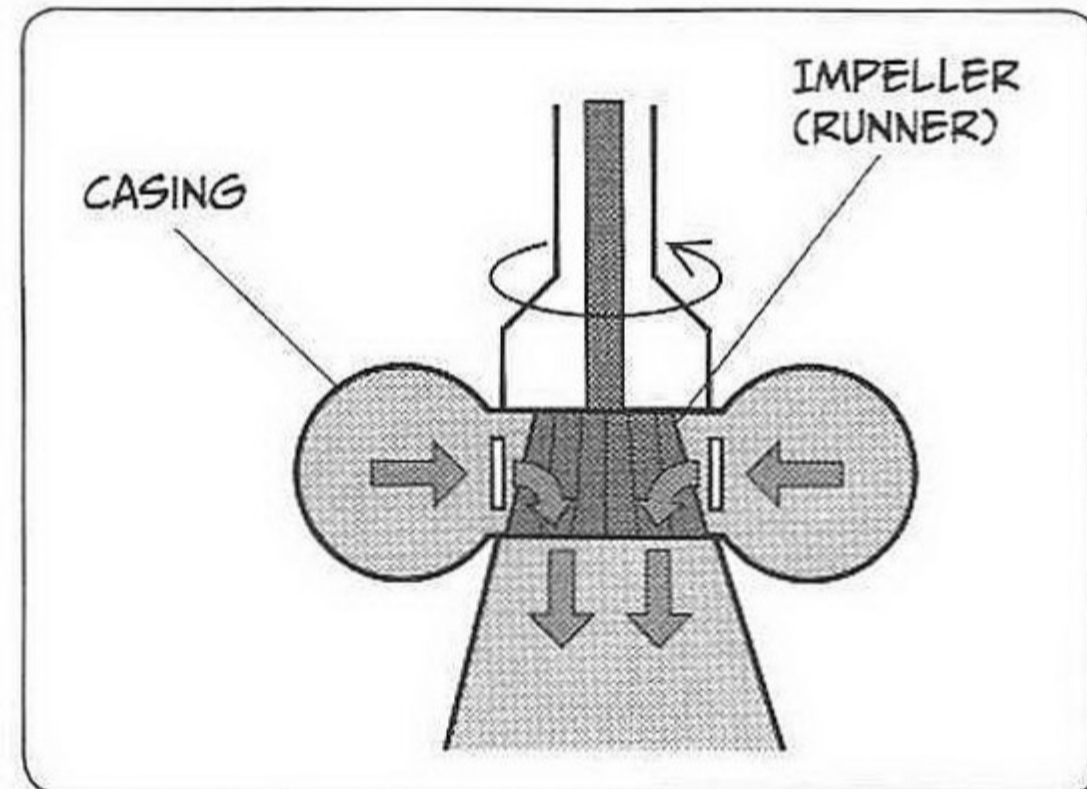

Francis turbine

A *Pelton wheel* is a water turbine that rotates from the recoil that occurs when water sprayed from a nozzle hits a spoon-shaped bucket (blade). It is useful in locations that have a high head.

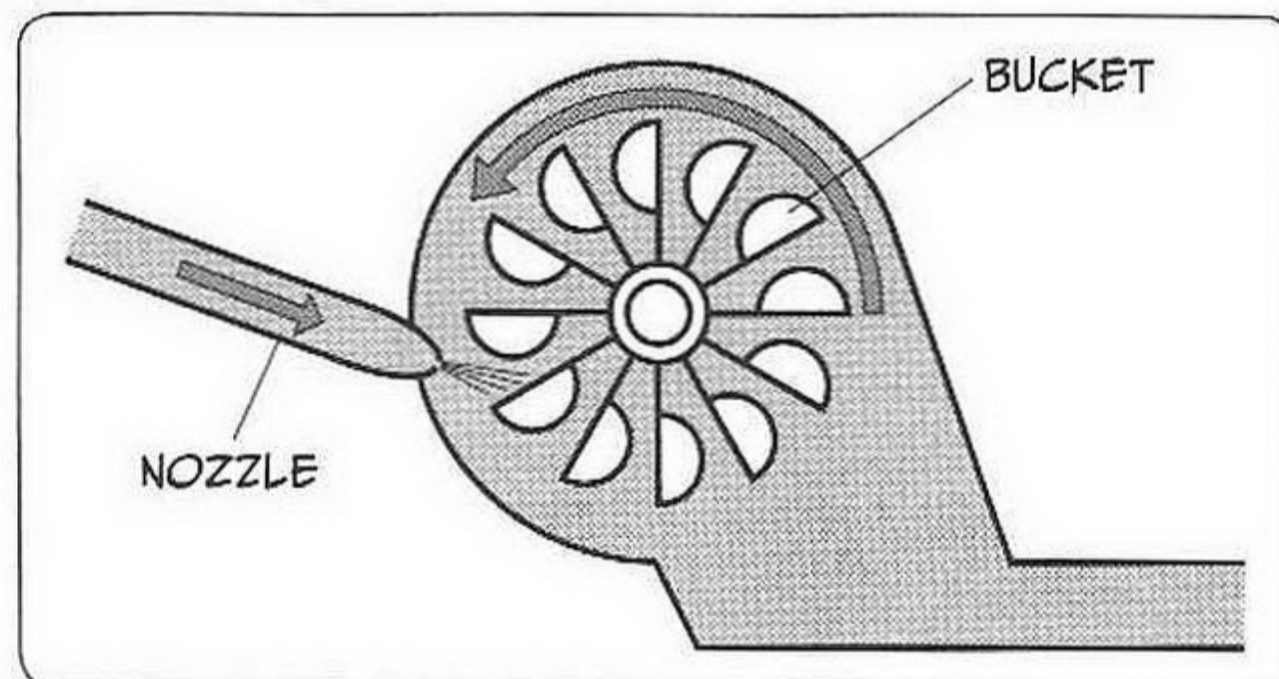

Pelton wheel

A *Kaplan turbine* is a water turbine that rotates because several propeller blades connected to a shaft adjust their angles according to variations in the amount of water flowing or the head. This kind of turbine is useful in locations having a low head. A type of Kaplan turbine that does not adjust the angle of the blades is called a *propeller turbine*.

Although hydroelectric power generation accounts for only 10 percent of Japan's power generation, it is a valuable method for a country with few resources.

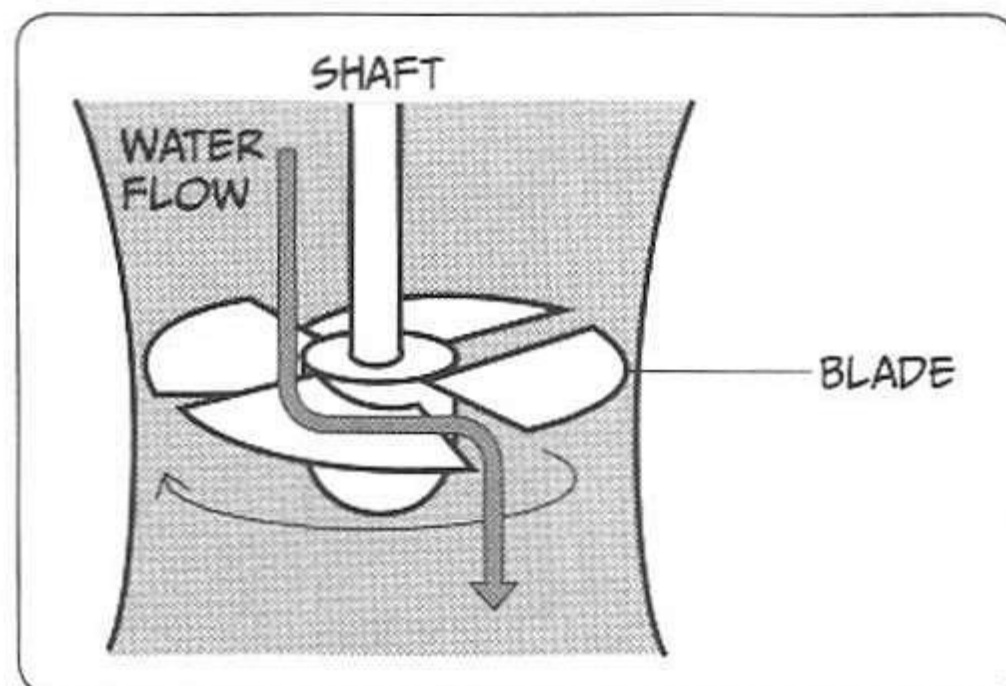

Kaplan turbine

WIND POWER GENERATION

Wind power generation uses wind power to turn a turbine; the turbine in turn rotates an electric generator to create electricity.

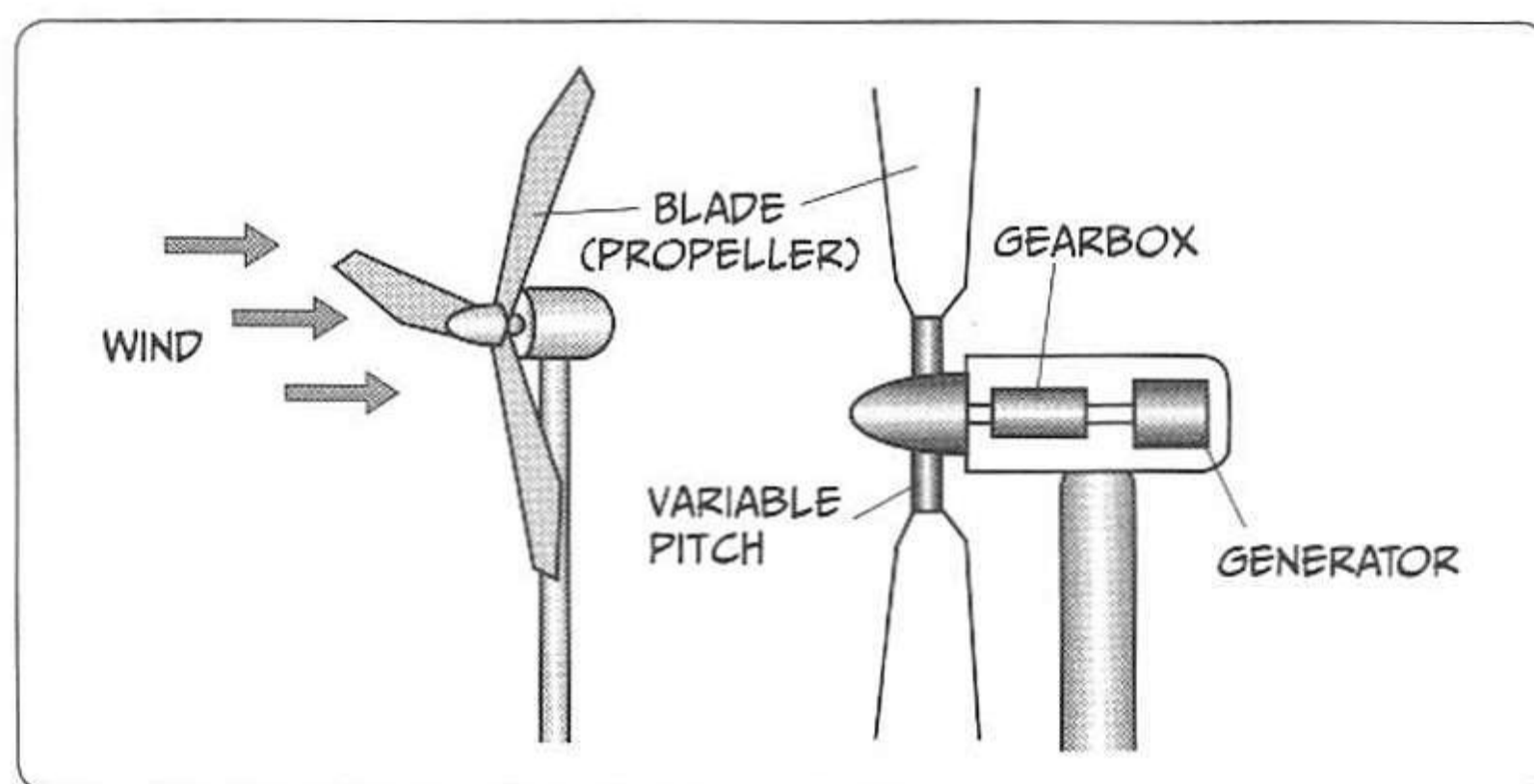

Mechanism of wind power generation (propeller wind turbine)

There are various types of wind turbines for wind power generation. A *propeller wind turbine*, which uses wind power energy very efficiently, is common. When wind hits the turbine's blades, it creates rotational motion, and the rotation speed is increased by a gear-box to turn an electrical generator. An *anemoscope (wind vane)* and an *anemometer (wind gauge)* constantly measure the wind conditions, and the direction of the propeller and angle of the blades are adjusted to the optimum state to use the wind power most effectively.

Although the power supplied by wind power generation is greatly affected by variations in the direction and speed of the wind, and the noise that is generated when the wind turbine rotates can be a problem, this is a clean, environmentally friendly power generation method that requires no fuel and produces no exhaust gases.



5

HOW CAN YOU CONVENIENTLY USE
ELECTRICITY?

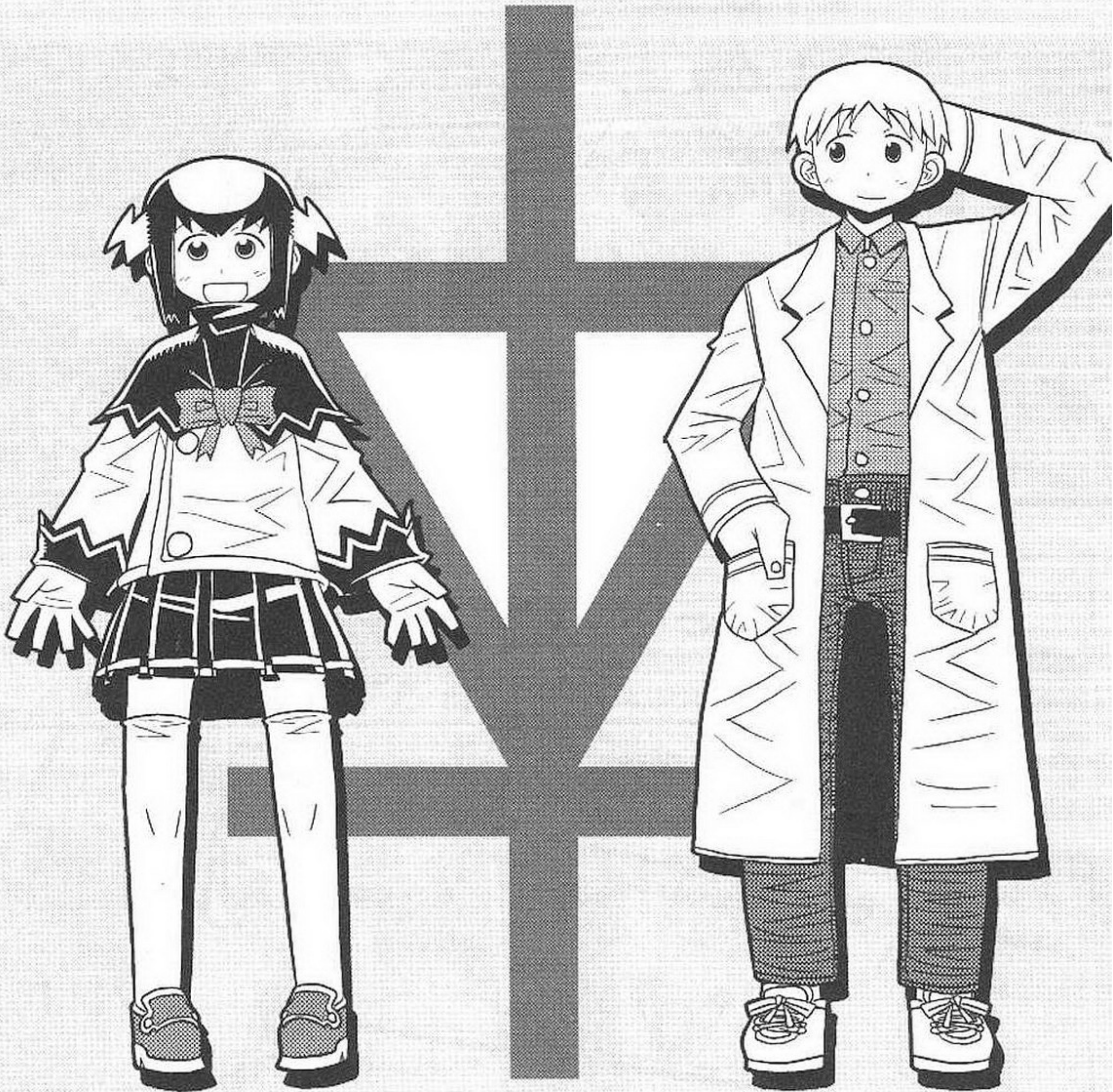

FORTUNATELY, HIKARU WAS ABLE TO REPAIR
YONOSUKE'S BREAKDOWN WITH THE
TECHNOLOGY AVAILABLE ON EARTH.

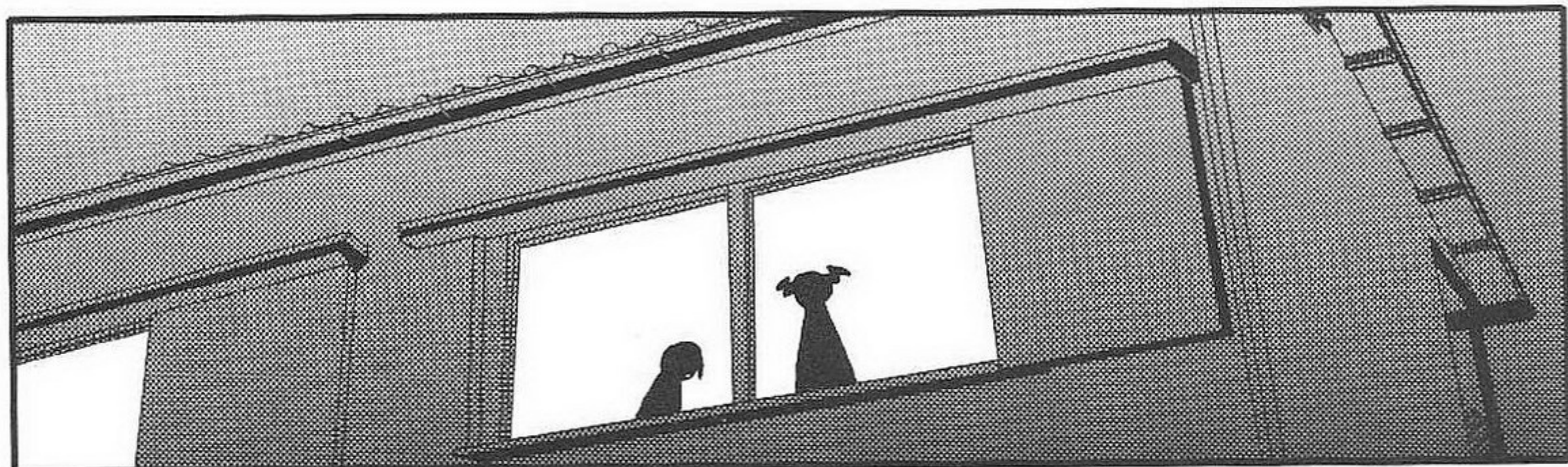

HE WORKED ON YONOSUKE EVERY NIGHT...



AND SEVERAL DAYS LATER...

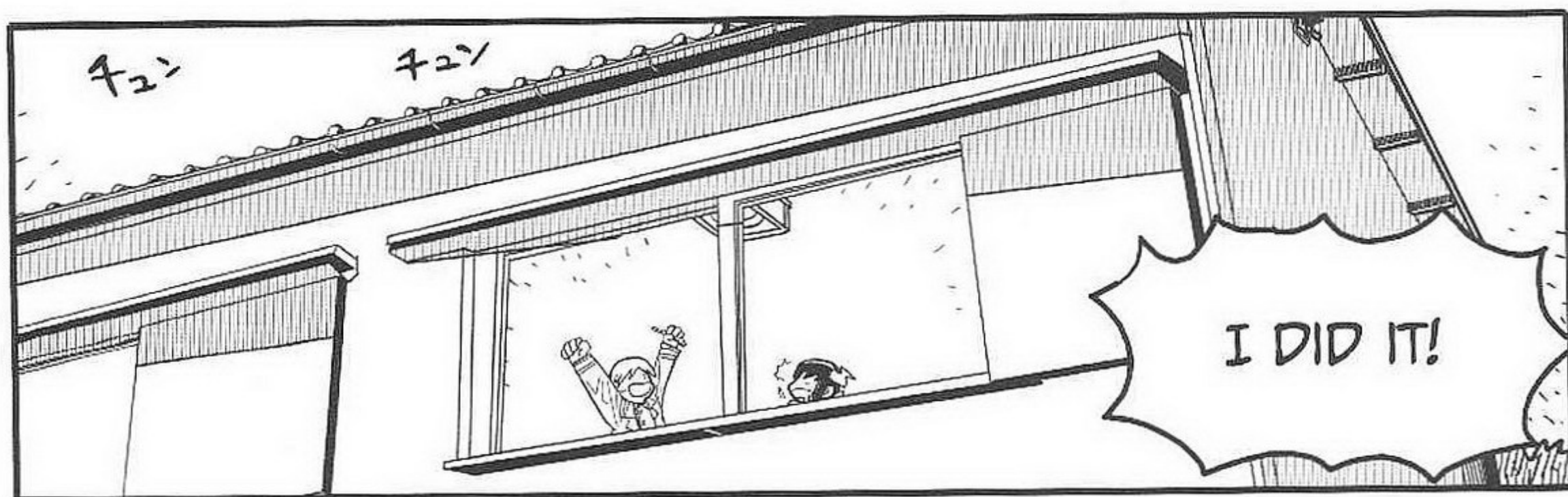

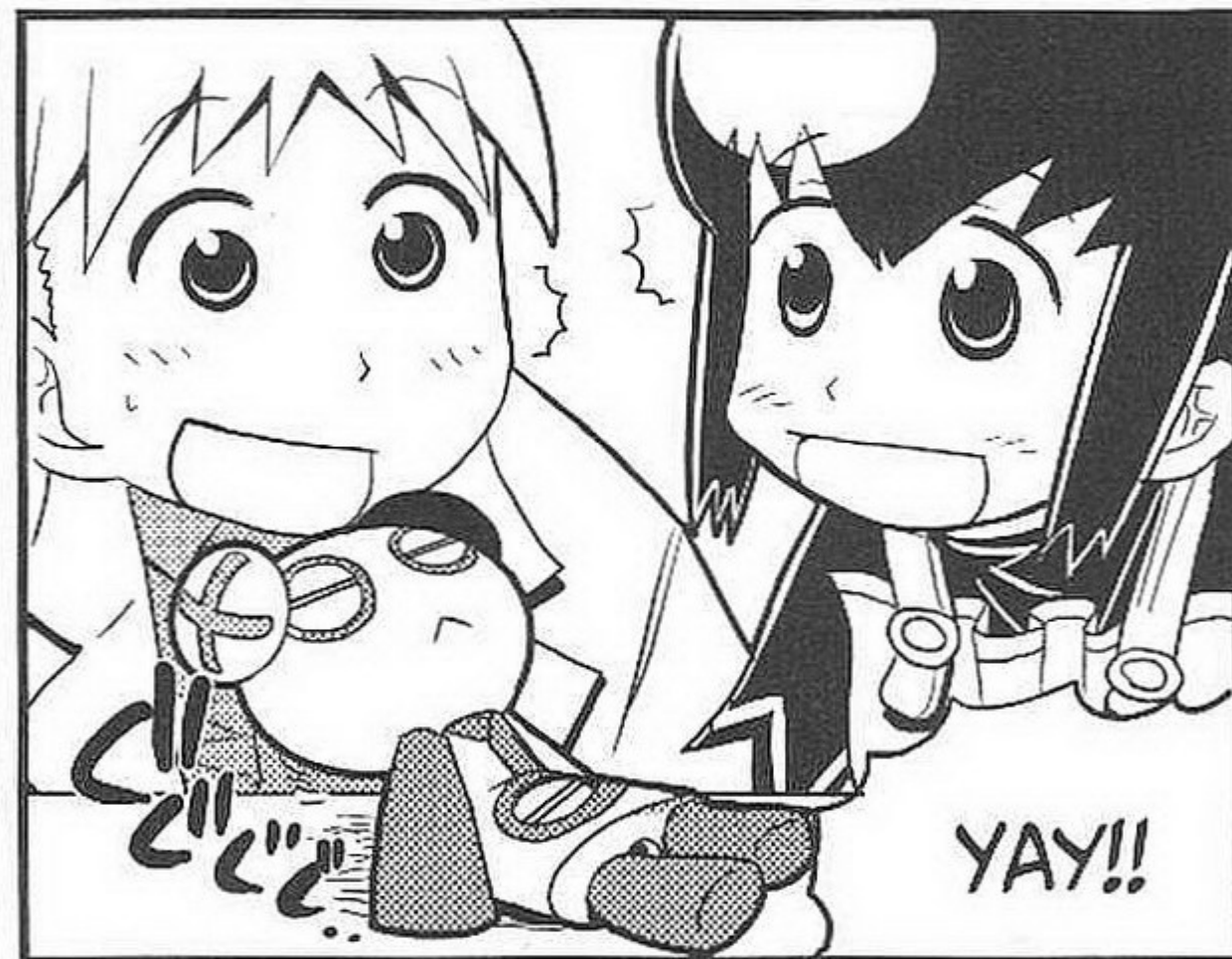
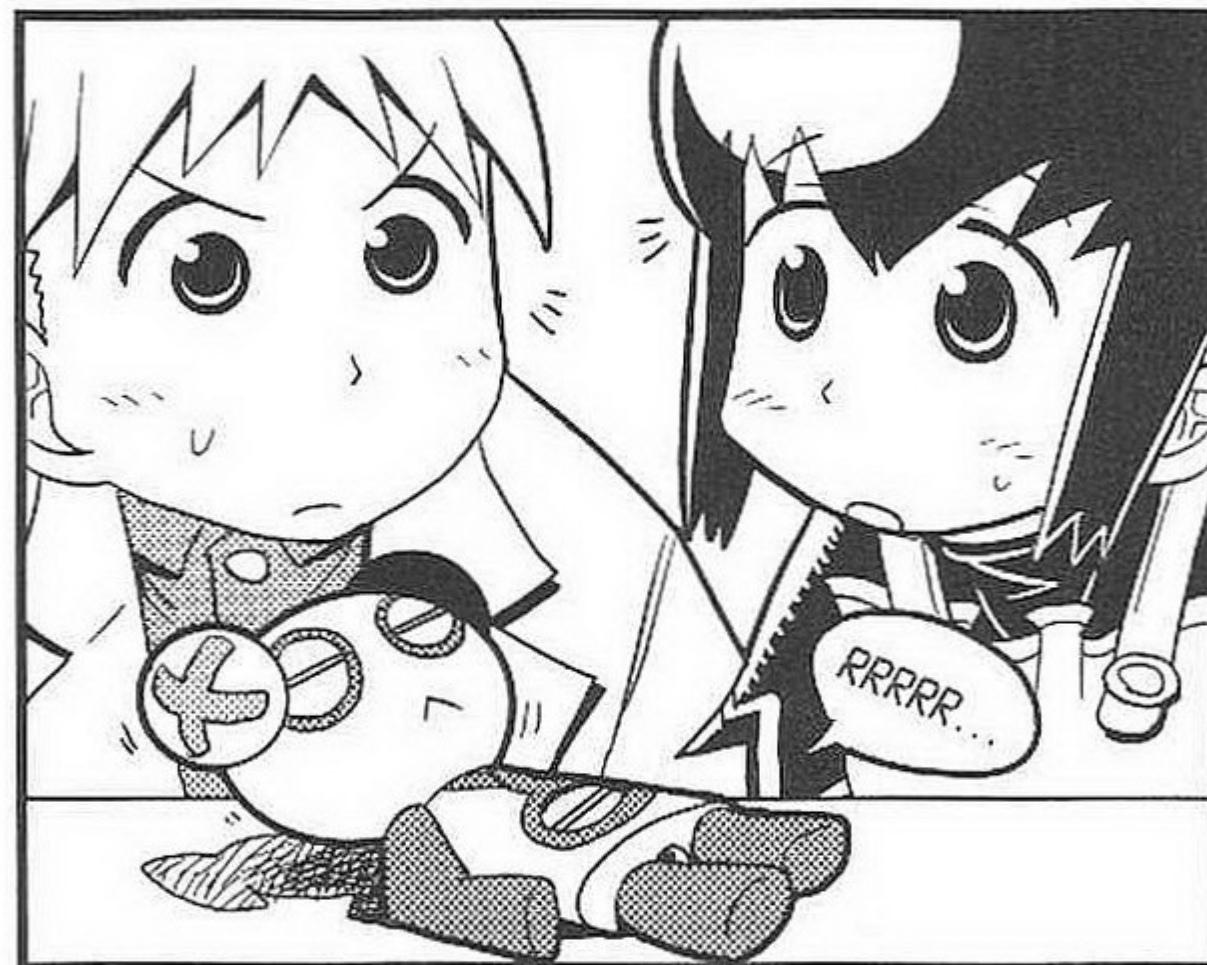



RING,
RING



OH, HI!!
CAN YOU HEAR
ME, TETEK
SENSEI?

WHAT HAPPENED?
ALL OF A SUDDEN YOU
WERE GONE!



YONOSUKE BROKE DOWN!
BUT HIKARU SENSEI FIXED
HIM FOR ME!

I WAS WORRIED
FOR A WHILE. BUT
SOMEHOW OR OTHER,
I MANAGED TO
REPAIR HIM...



...I THINK.

YOU THINK?



BY THE WAY, TODAY'S
THE DAY YOU'RE
SCHEDULED TO RETURN
TO ELECTOPIA. ARE
YOU READY?

WHAAAAT!?
SO SOON?

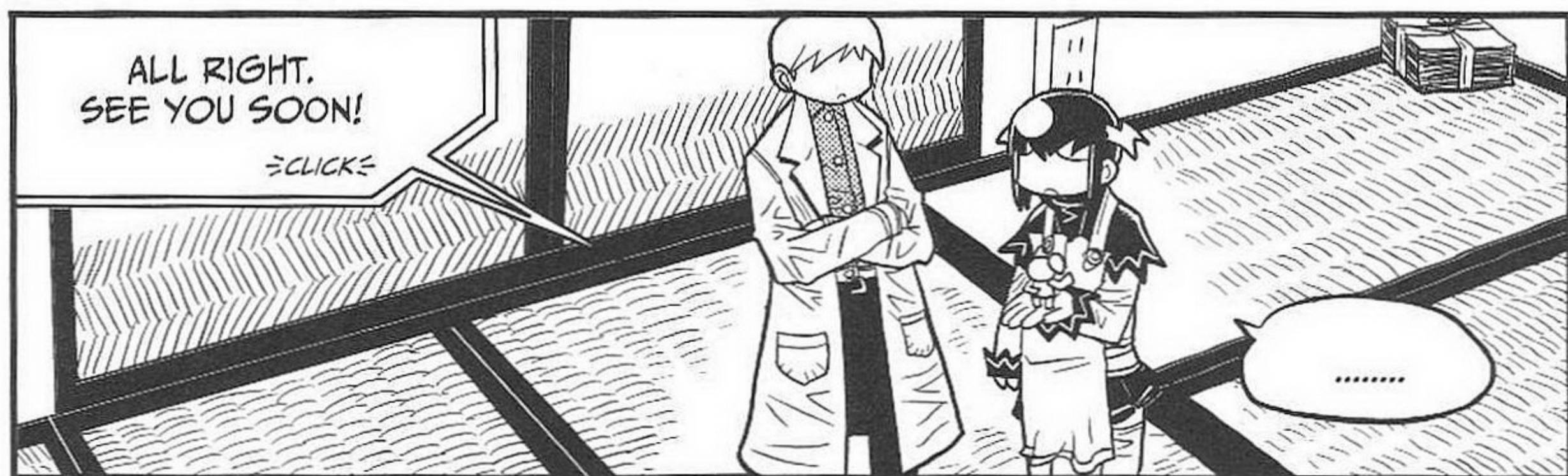



WHAT ARE SEMICONDUCTORS?

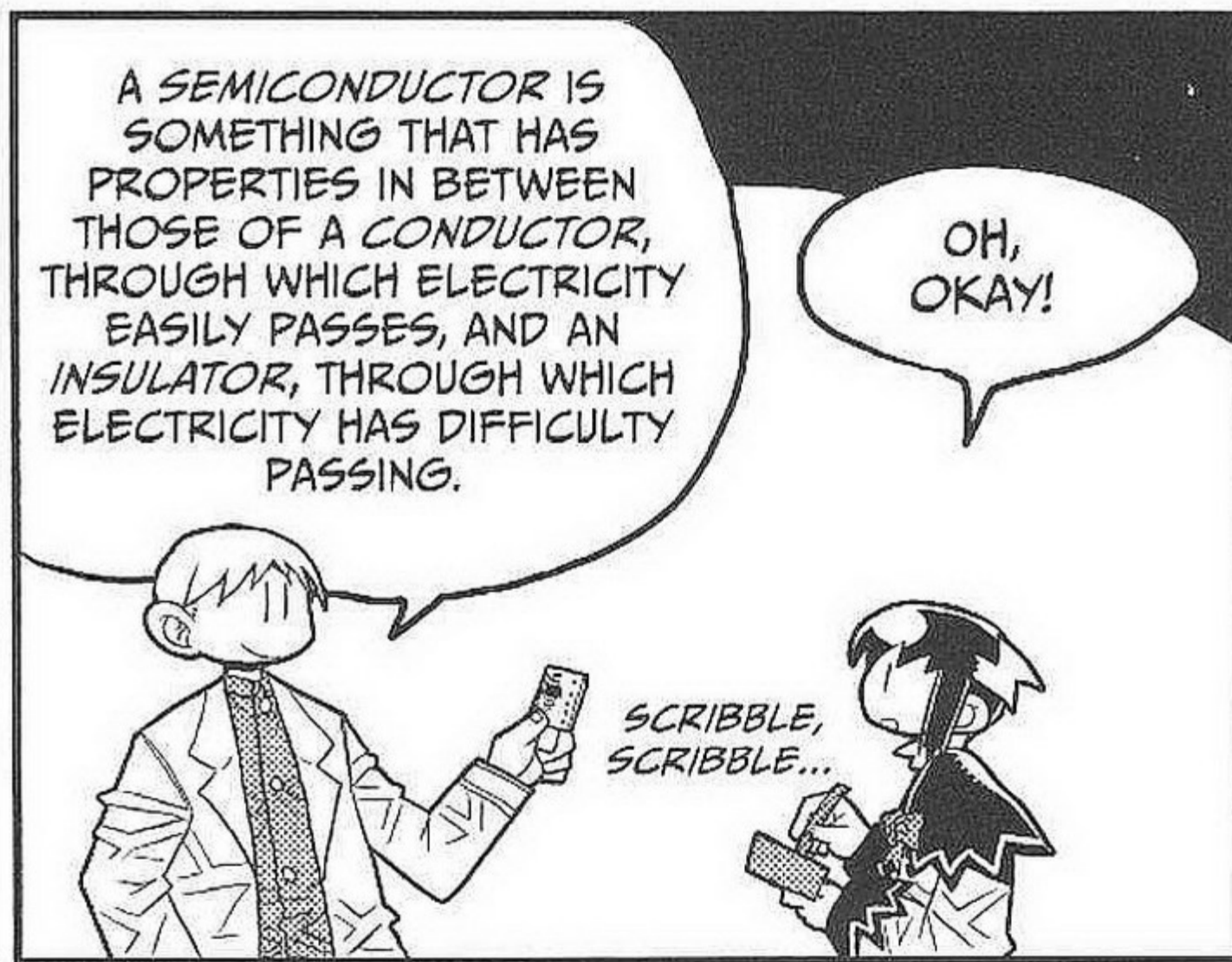
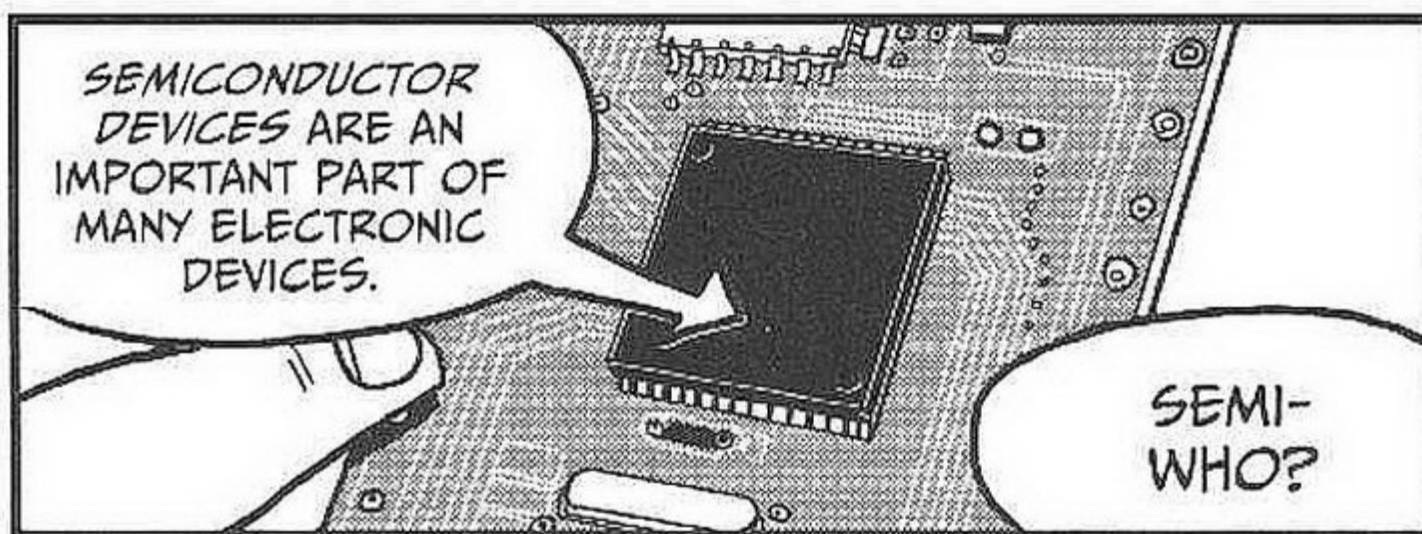

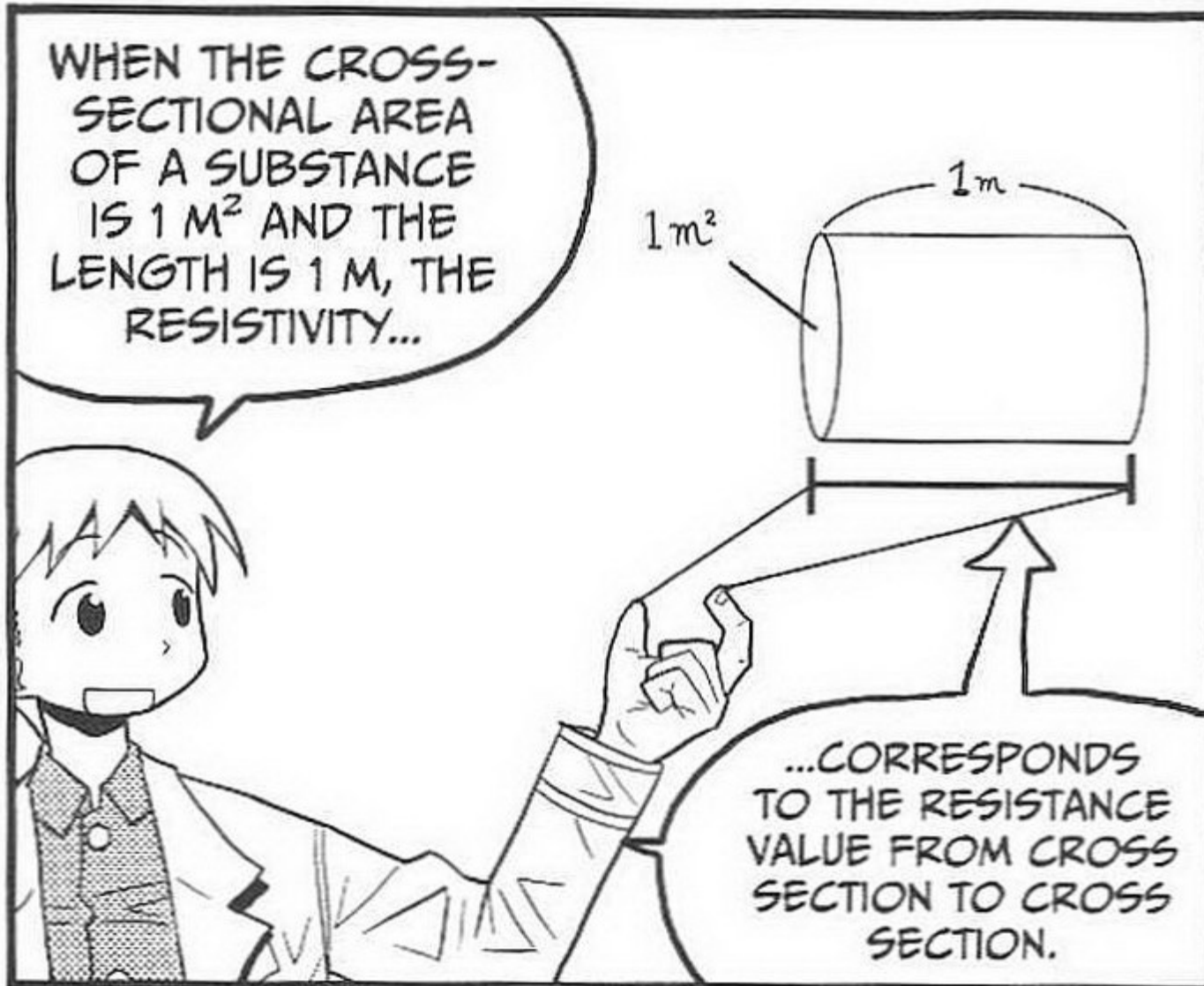

ELECTRICITY FLOWS EASILY ← RESISTIVITY IN Ω M → ELECTRICITY HAS DIFFICULTY FLOWING

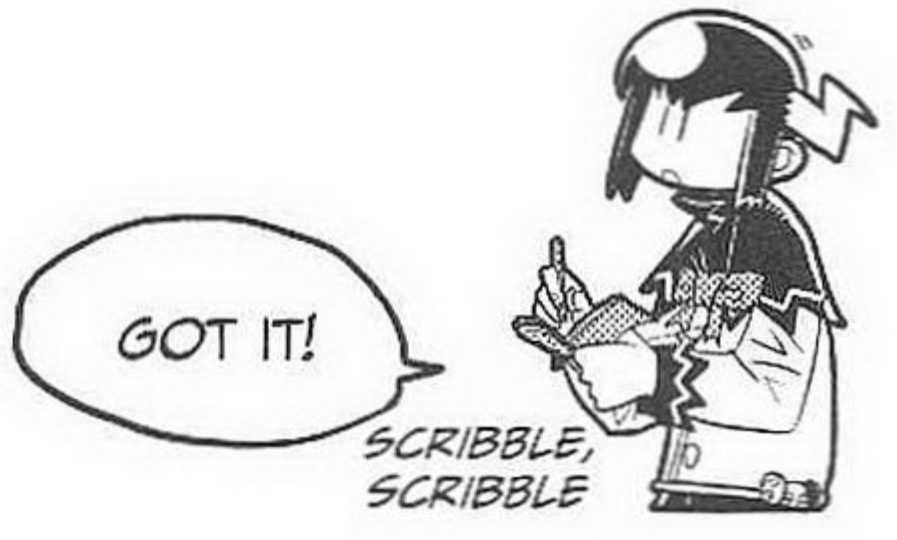
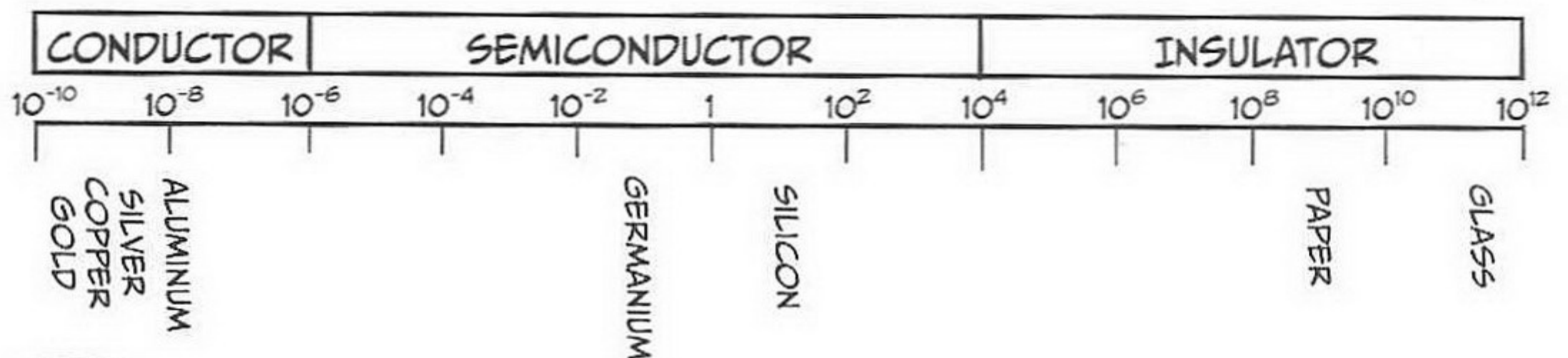

IN PARTICULAR, SEMICONDUCTORS ARE SUBSTANCES WHOSE ELECTRICAL CHARACTERISTICS CHANGE DUE TO THE EFFECTS OF HEAT, LIGHT, OR ELECTRICITY.

SEMICONDUCTORS MAY CONTAIN SUBSTANCES SUCH AS SILICON OR GERMANIUM.

CHEMICAL SYMBOL

Ge **Si**
GERMANIUM SILICON

THEY SOUND MYSTERIOUS!

DIODES

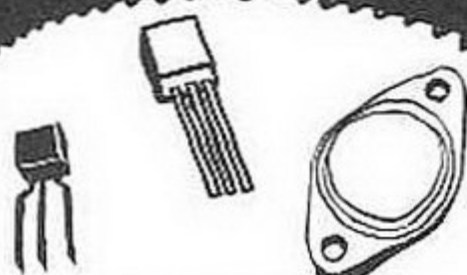

TRANSISTORS

COMPONENTS SUCH AS DIODES OR TRANSISTORS, WHICH ARE CREATED USING SEMICONDUCTORS, ARE CALLED SEMICONDUCTOR DEVICES.

WHEN YOU PUT IT THAT WAY, IT'S EASY TO UNDERSTAND!

Ge

Si

SILICON OR GERMANIUM ARE ELEMENTS, BUT...

...A SEMICONDUCTOR THAT IS MADE UP OF TWO OR MORE ELEMENTS SUCH AS GALLIUM ARSENIDE IS CALLED A COMPOUND SEMICONDUCTOR.

GALLIUM + ARSENIC
=
GALLIUM ARSENIDE

BOINK

Ga

As

THAT MAKES SENSE!

THERE ARE ALSO CASES IN WHICH A SMALL AMOUNT OF AN IMPURITY IS MIXED WITH THE SILICON OR GERMANIUM.

THIS PROCESS IS CALLED DOPING, AND THE RESULT IS CALLED AN EXTRINSIC SEMICONDUCTOR.

IMPURITY

SILICON Si

IMPURITY

Si

EXTRINSIC SEMICONDUCTOR

A SEMICONDUCTOR WITH NO IMPURITY MIXED IN IS CALLED AN INTRINSIC SEMICONDUCTOR.

THERE SURE ARE A LOT OF TYPES OF SEMICONDUCTORS!

Si

INTRINSIC SEMICONDUCTOR

THE RAW MATERIAL MOST OFTEN USED IN SEMICONDUCTORS IS SILICON.

SILICON IS AN ELEMENT REPRESENTED BY THE SYMBOL Si.

Si
SILICON

I SEE!

NORMALLY, SILICON IS FOUND IN A SUBSTANCE CALLED SILICON DIOXIDE, WHICH IS A REFINED PRODUCT OFTEN USED AS THE RAW MATERIAL FOR SEMICONDUCTOR DEVICES.

REFINED

SILICON DIOXIDE

RAW MATERIAL FOR SEMI-CONDUCTOR

THE PURITY OF THIS REFINED SILICON IS 99.999999999 PERCENT, WHICH IS SOMETIMES REFERRED TO AS ELEVEN-NINE.

THIS IS EXTREMELY CLOSE TO 100 PERCENT!!!

9 x 11

99.999999999%

ONE, TWO, THREE...

A SILICON ATOM HAS FOUR VALENCE ELECTRONS IN ITS OUTERMOST SHELL.

The diagram shows a central nucleus labeled 'Si' with two concentric circles representing electron shells. The inner shell contains two electrons, and the outer shell contains six electrons. Four of these outer electrons are specifically highlighted with small circles and lines, representing valence electrons. Arrows point from the text above to these four valence electrons.

THESE ATOMS JOINTLY CONTRIBUTE FOUR ELECTRONS TO FORM A FIRM, REGULAR CRYSTAL.

The diagram shows a 3D lattice of silicon atoms, each represented by a circle with 'Si' inside. Each atom is connected to four neighboring atoms, forming a continuous, rigid network. A large, stylized Japanese sound effect 'カチカチ' (kachi kachi) is overlaid on the lattice, suggesting a firm, clinking structure. A speech bubble from the right says 'COOL!'.

*WELL-BUILT

IT'S LIKE THEY'RE HOLDING HANDS! LIKE THIS!

SQUEEZE

YEAH...UH... LIKE THAT.

A boy and a girl are shown holding hands. The boy is squeezing the girl's hand, and the girl is squeezing the boy's hand. This action is used as a metaphor for the silicon atoms holding hands in a crystal lattice.

A SILICON CRYSTAL DOES NOT HAVE ANY ELECTRONS THAT CAN FREELY MOVE AROUND, SO ELECTRICITY WILL HARDLY PASS THROUGH IT.

LARGE AMOUNT

SMALL AMOUNT

ELECTRICITY

The diagram shows a single silicon atom 'Si' in the center. A large, thick arrow labeled 'LARGE AMOUNT' points towards it from the left, and a much thinner arrow labeled 'SMALL AMOUNT' points away from it to the right. The word 'ELECTRICITY' is written below the arrows.

THAT'S BECAUSE THE VALENCE ELECTRONS OF THE SILICON ATOMS ARE HOLDING HANDS!

SLAP

ELECTRICITY

THAT'S RIGHT!

The boy is slapping the girl's hand. The sound effect 'SLAP' is written in a circle above the hand. The girl looks surprised. The boy explains that because the valence electrons are holding hands, electricity cannot pass through.

IF AN ELEMENT WITH FIVE VALENCE ELECTRONS, LIKE PHOSPHORUS, IS MIXED IN WITH A SILICON CRYSTAL...

PHOSPHORUS

...THE PHOSPHORUS AND SILICON BOND, AND ONE VALENCE ELECTRON ESCAPES.

SILICON

PHOSPHORUS

SILICON

IT BECOMES A FREE ELECTRON, RIGHT?

FREE ELECTRON

THAT'S RIGHT! THIS CAUSES THE ELECTRICAL CONDUCTIVITY OF THIS SEMICONDUCTOR TO INCREASE.

THIS SEMICONDUCTOR IS CALLED AN N-TYPE SEMICONDUCTOR BECAUSE THE ELECTRON, WHICH HAS A NEGATIVE ELECTRICAL PROPERTY, BECOMES A CARRIER OF ELECTRICITY.

? WHAT'S THIS N?

SIGH...

...WHAT'S WRONG?

THE N STANDS FOR NEGATIVE.

NEGATIVE

AH...!

NOW, LET'S SAY WE MIXED IN A LITTLE OF THE ELEMENT BORON, WHICH HAS THREE VALENCE ELECTRONS.

BORON

THE BORON AND SILICON BOND, BUT THERE IS AN EMPTY SEAT LEFT IN THE SPACE THAT DOESN'T HAVE AN ELECTRON.

EMPTY SEAT?

HOLE

THIS EMPTY SEAT IS CALLED A HOLE.

HOLES ARE PLACES ELECTRONS ARE VACANT IN COVALENT BONDS.

HOLE

HOLE

DRIFT

DRIFT

HOLE

YOU CAN THINK OF THE HOLE AS A FREE ELECTRON WITH A POSITIVE CHARGE.

OKAY...

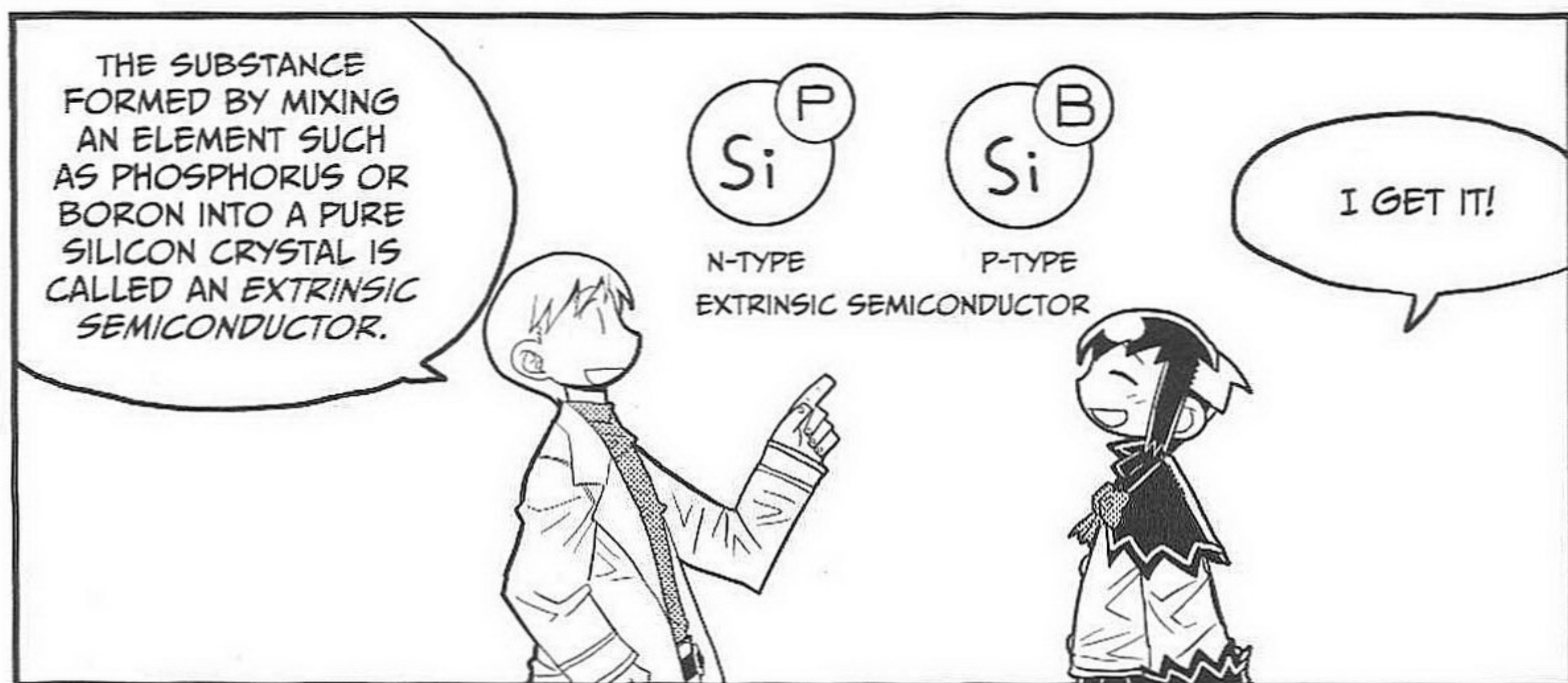

DIODES AND TRANSISTORS

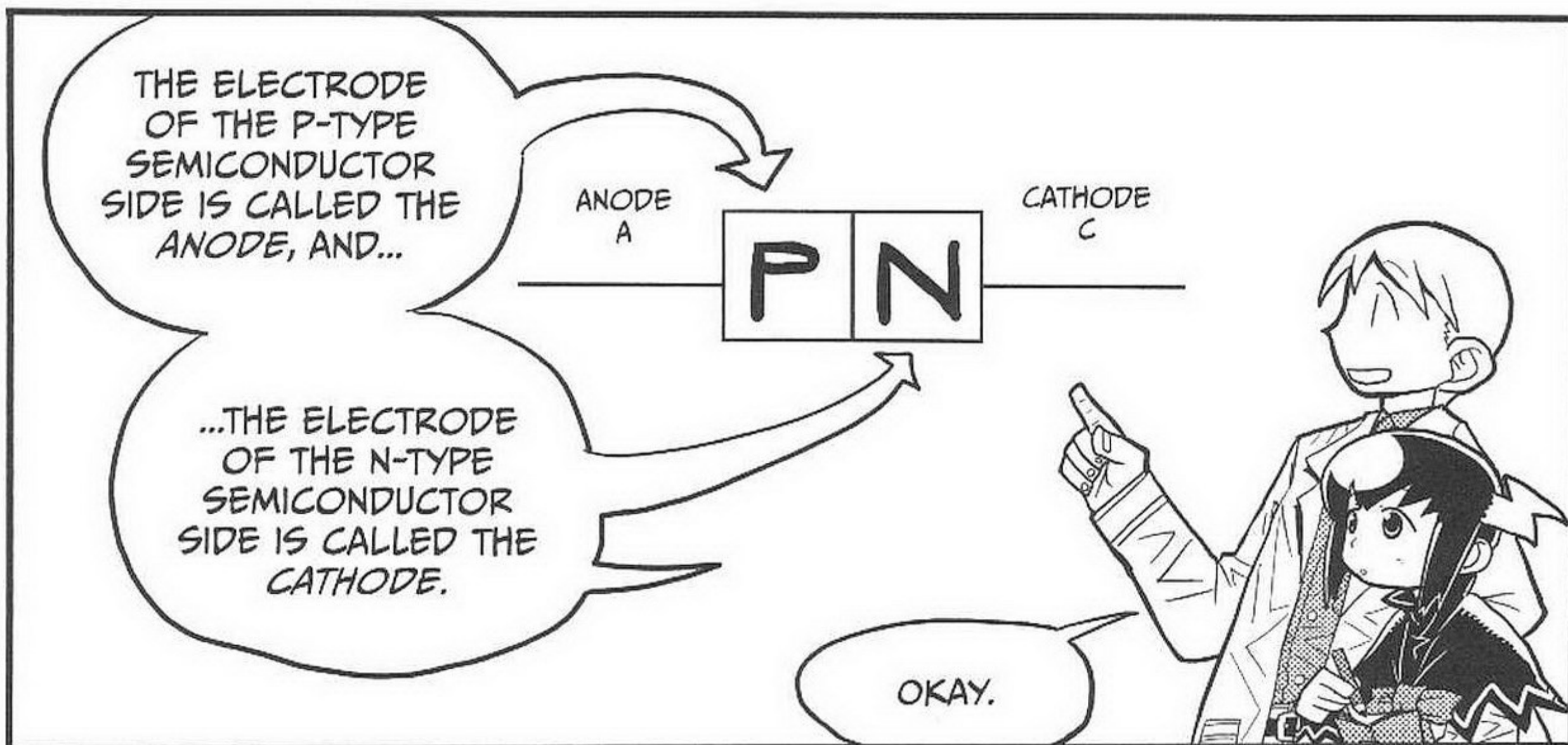
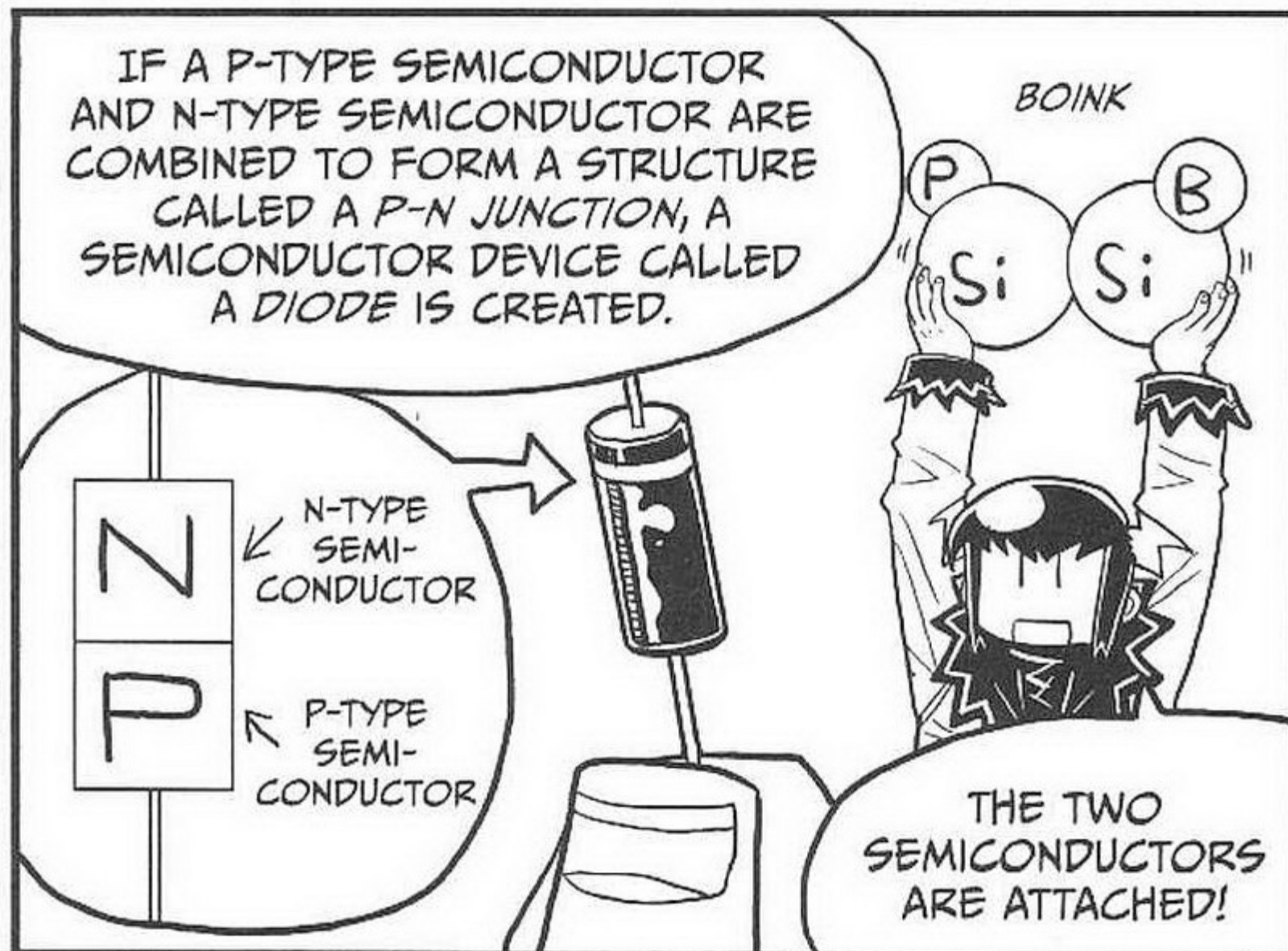
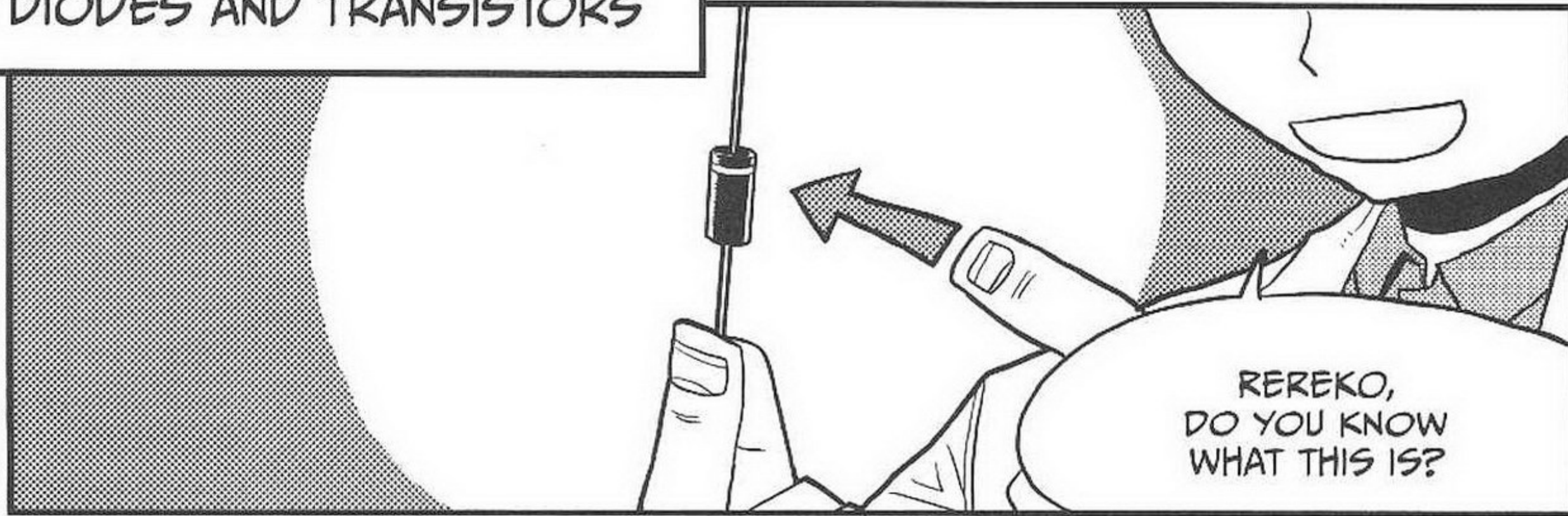

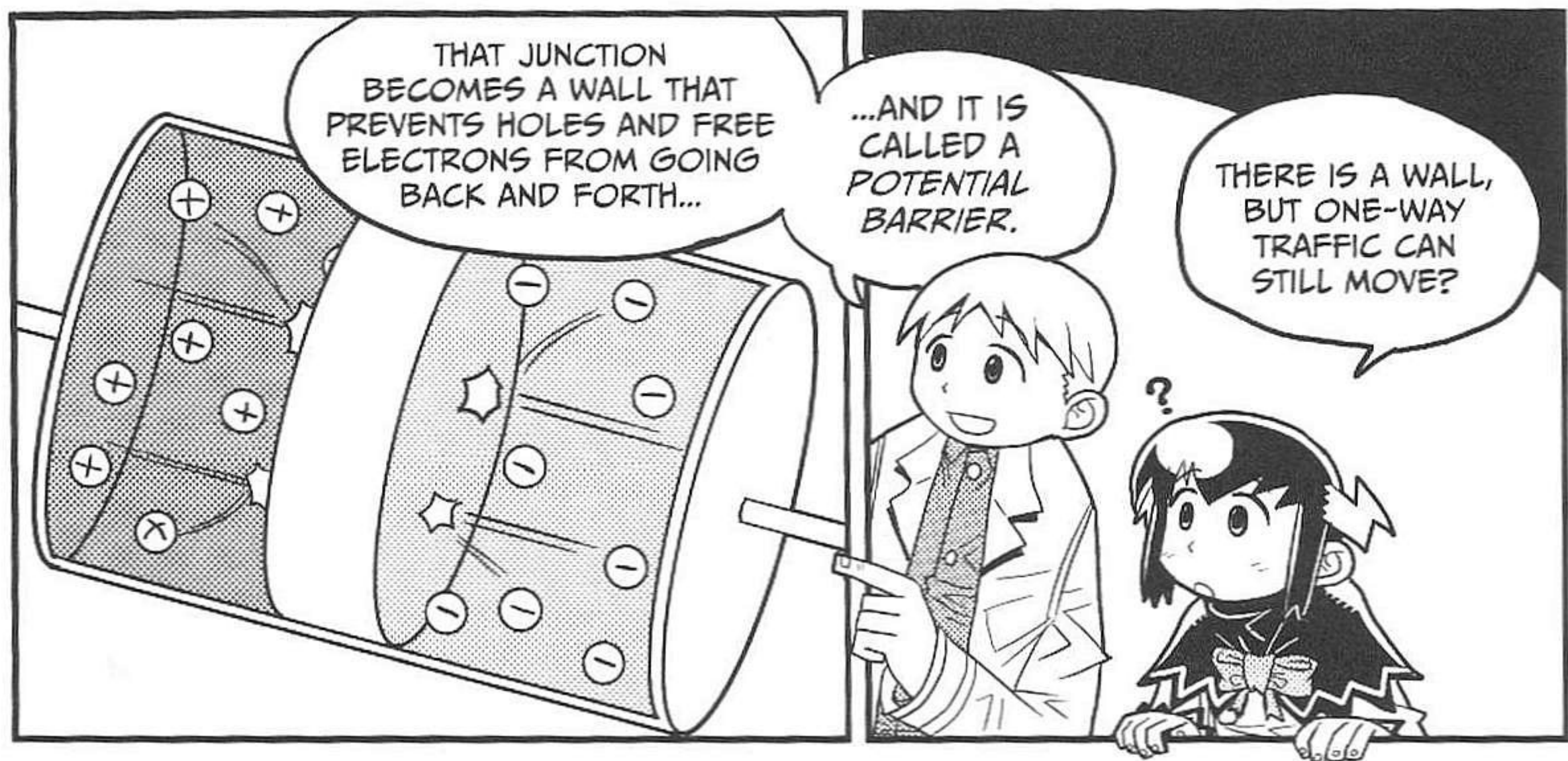
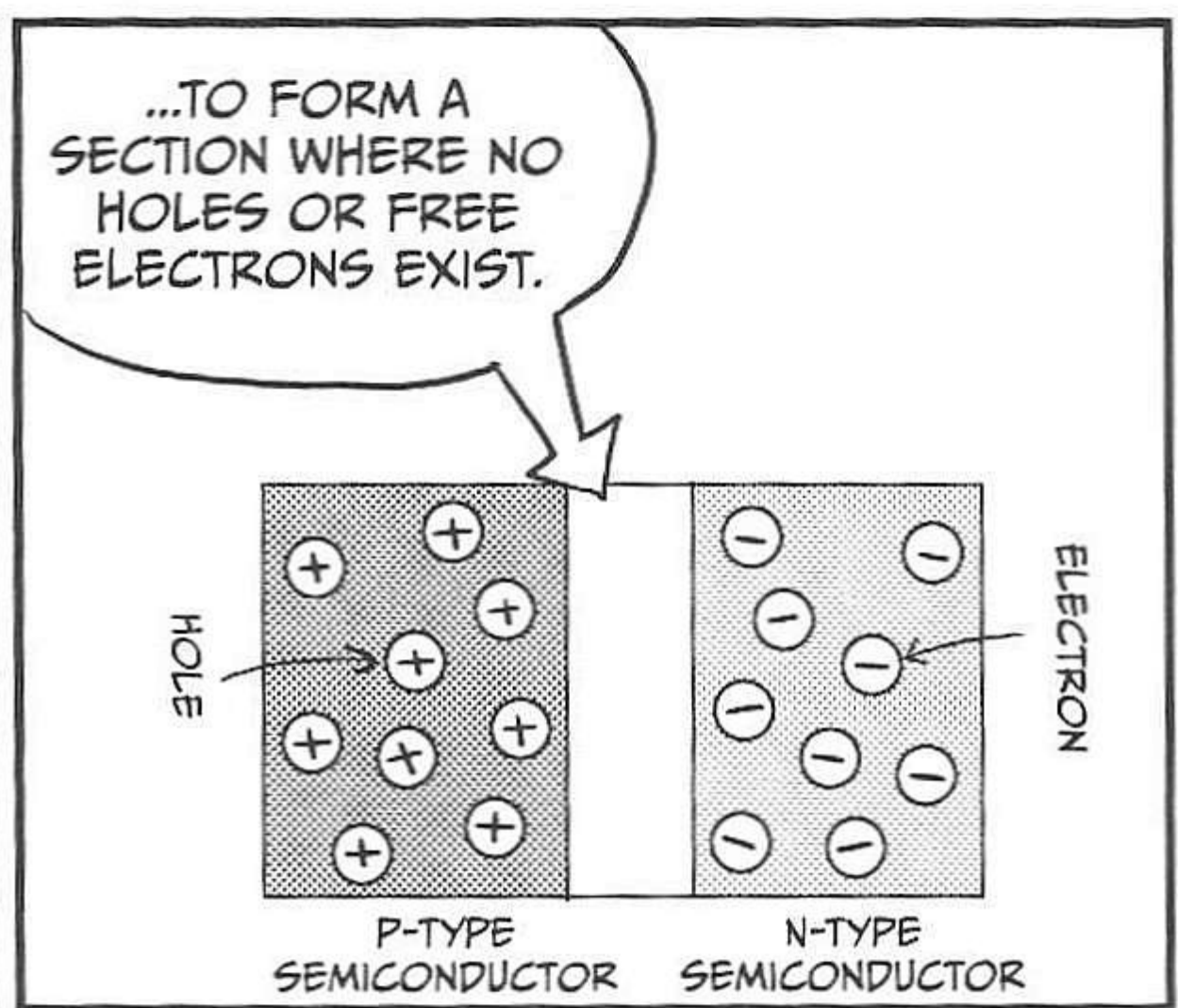
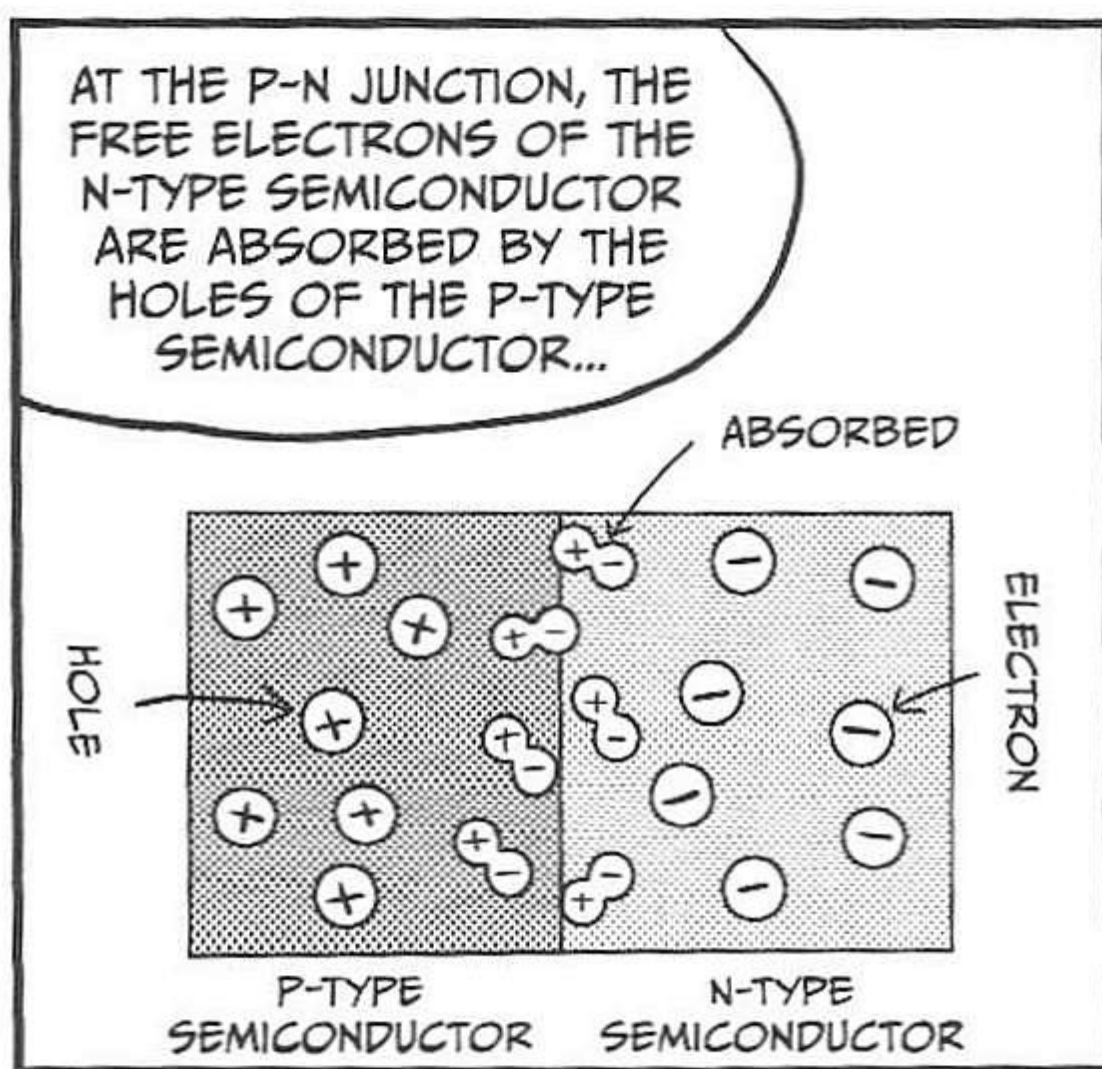
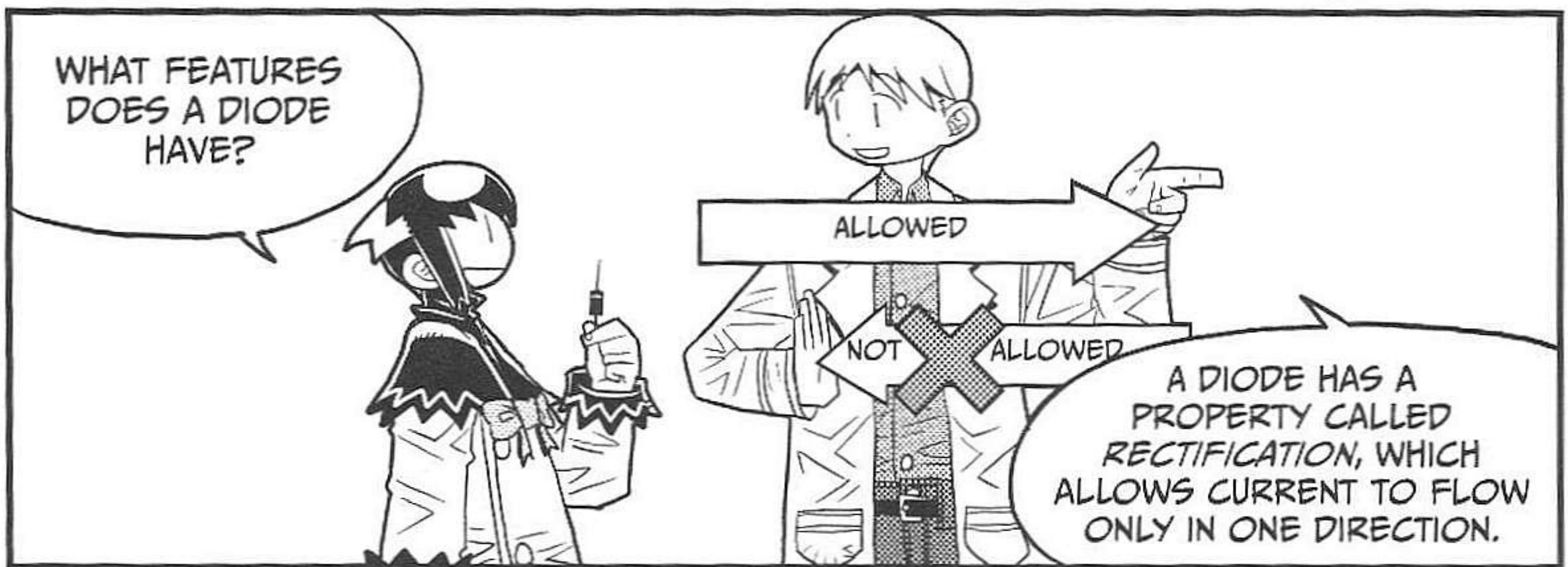



YES. IF THERE IS ENOUGH VOLTAGE, THIS BARRIER CAN BE BROKEN.



NOW I'LL EXPLAIN HOW DIODES WORK IN A CIRCUIT.

I'M READY!

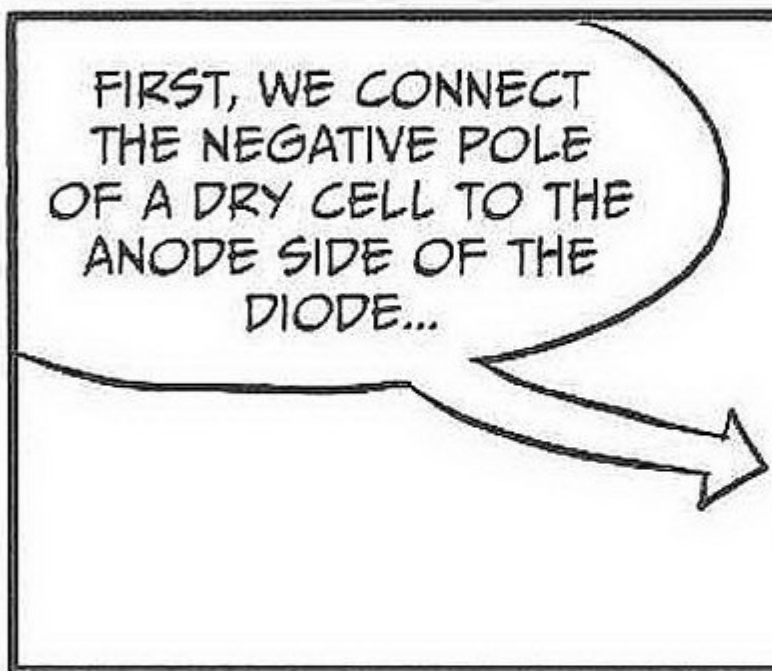

FIRST, WE CONNECT THE NEGATIVE POLE OF A DRY CELL TO THE ANODE SIDE OF THE DIODE...

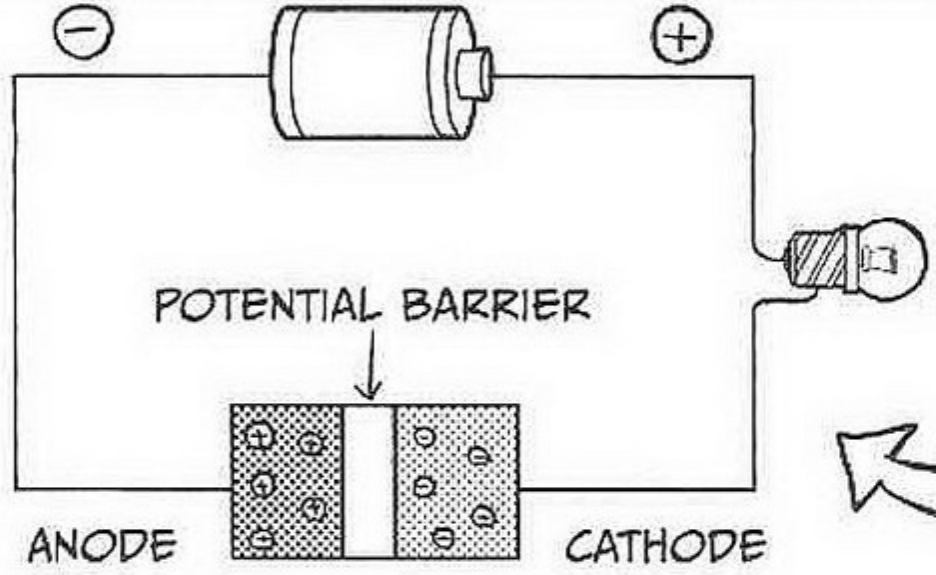

...AND CONNECT THE POSITIVE POLE TO THE CATHODE SIDE...

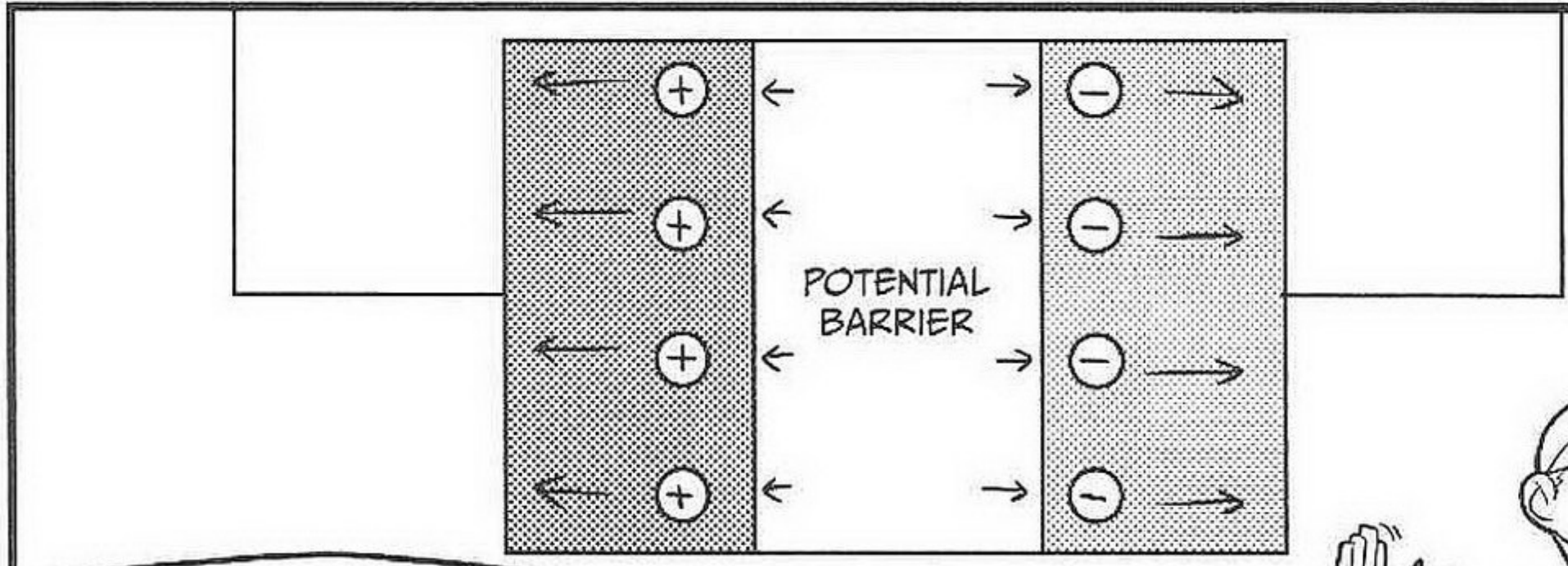

WHEN WE DO THIS, SINCE THE HOLES OF THE P-TYPE SEMICONDUCTOR AND THE FREE ELECTRONS OF THE N-TYPE SEMICONDUCTOR ARE ATTRACTED TO THE RESPECTIVE ELECTRODES, THE POTENTIAL BARRIER WILL INCREASE, AND CURRENT WILL HARDLY FLOW AT ALL...

THIS KIND OF APPLICATION OF VOLTAGE IS CALLED REVERSE BIAS.



THAT MAKES SENSE!

NEXT, LET'S TRY REVERSING THE DIRECTION OF THE DRY CELL.

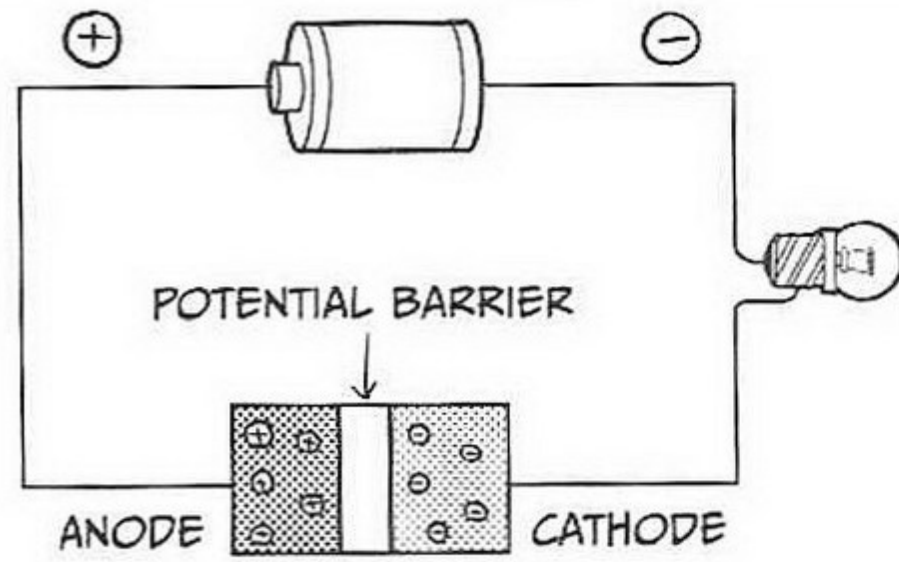
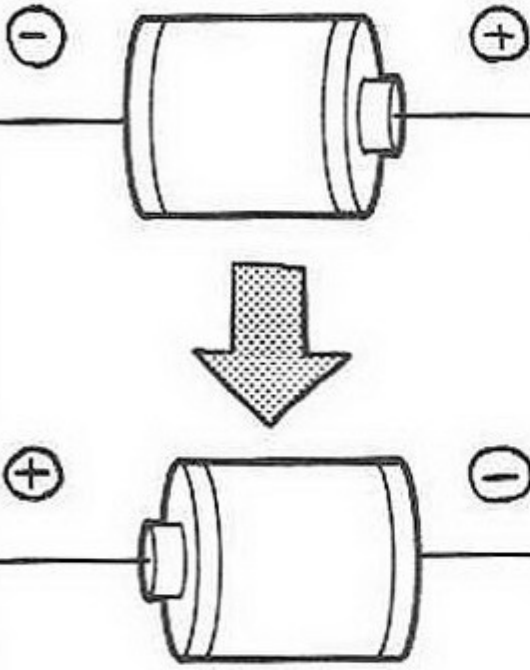

THE POSITIVE POLE IS CONNECTED TO THE ANODE SIDE, AND THE NEGATIVE POLE IS CONNECTED TO THE CATHODE SIDE, RIGHT?

YUP!

IN THIS CASE, THE FREE ELECTRONS OF THE N-TYPE SEMICONDUCTOR ARE PUSHED BY THE ELECTRONS THAT WERE DELIVERED FROM THE NEGATIVE POLE OF THE DRY CELL. THEY OVERCOME THE POTENTIAL BARRIER AND MOVE TO THE ANODE.

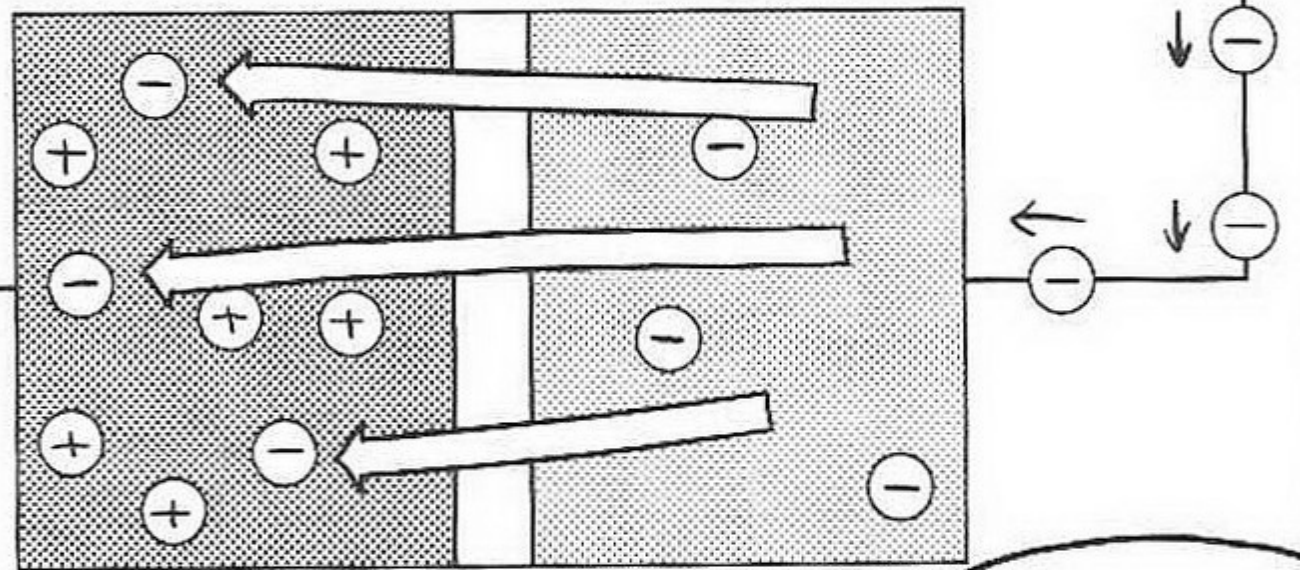

HMMM...

THE HOLES OF THE P-TYPE SEMI-CONDUCTOR ARE ALSO DRAWN TOWARD THE NEGATIVE POLE AND MOVE TO THE N-TYPE SEMICONDUCTOR.

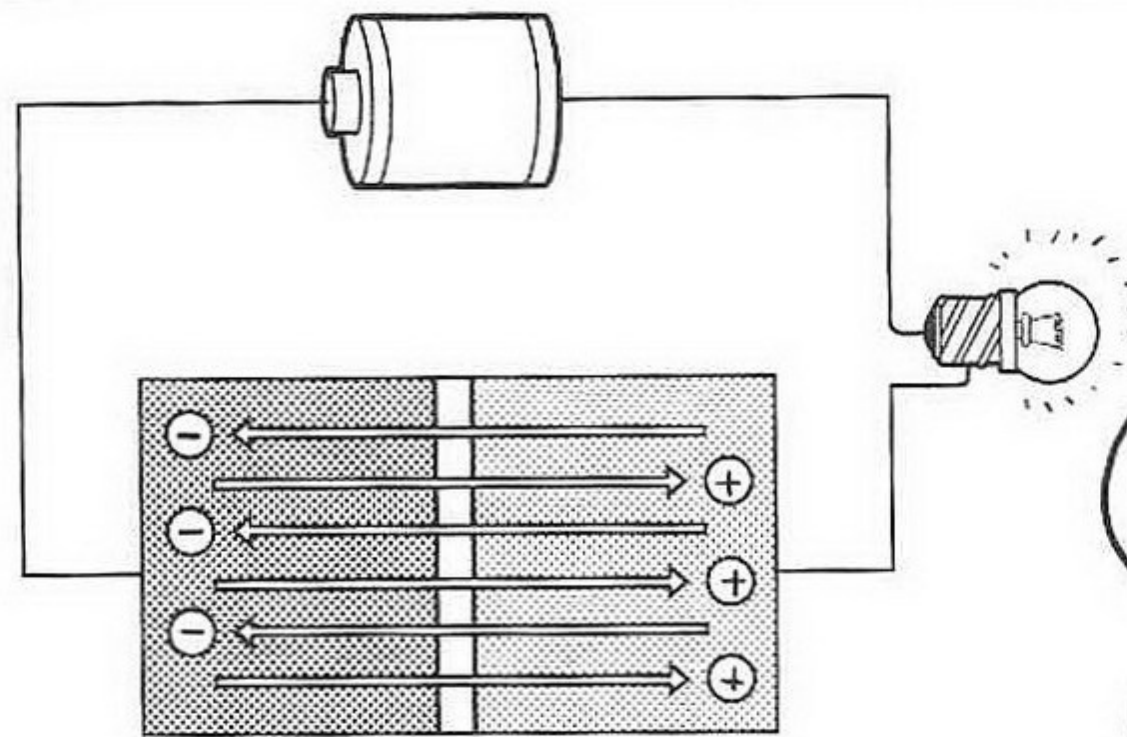

THIS ENABLES ELECTRICITY TO FLOW!



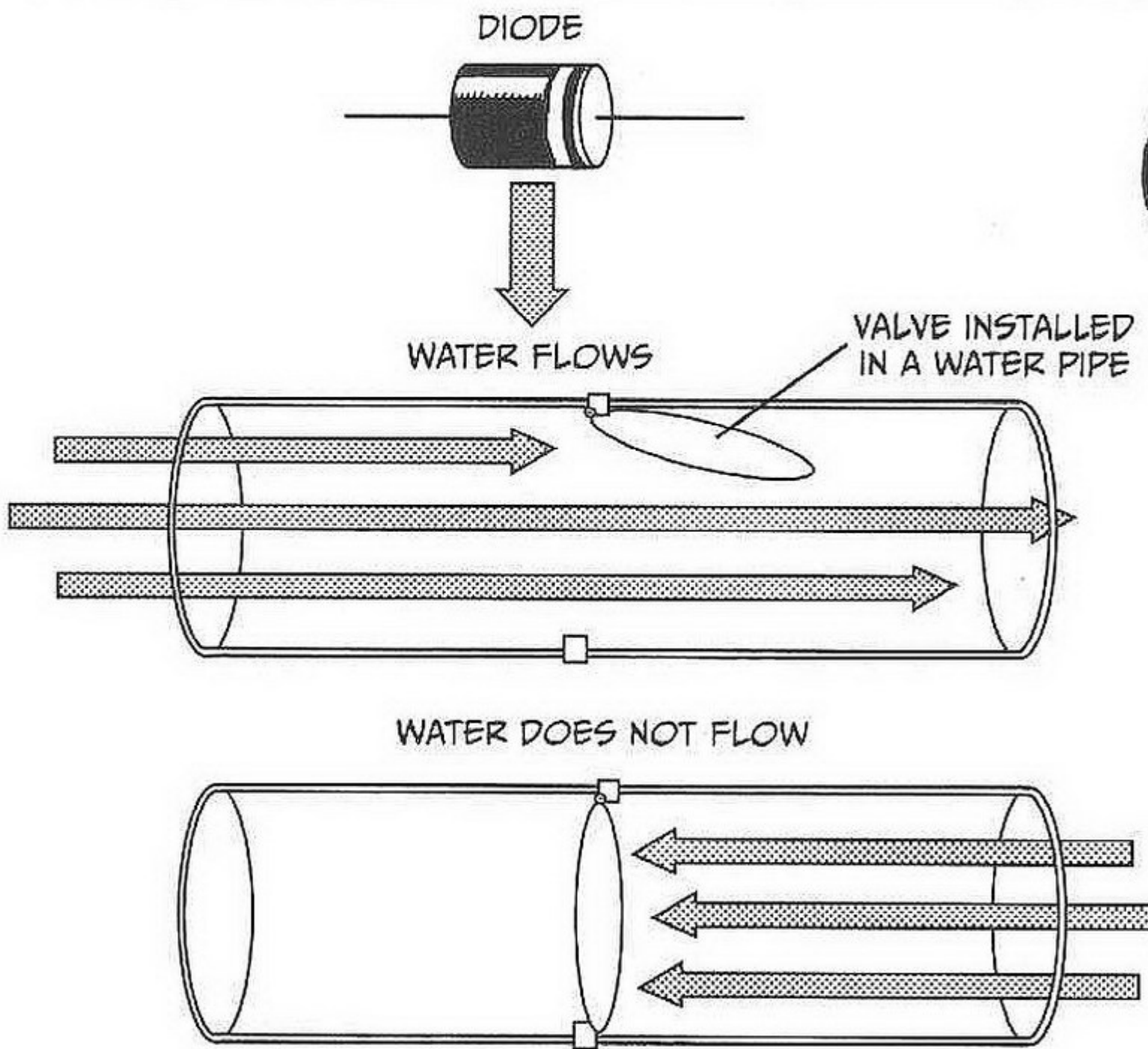
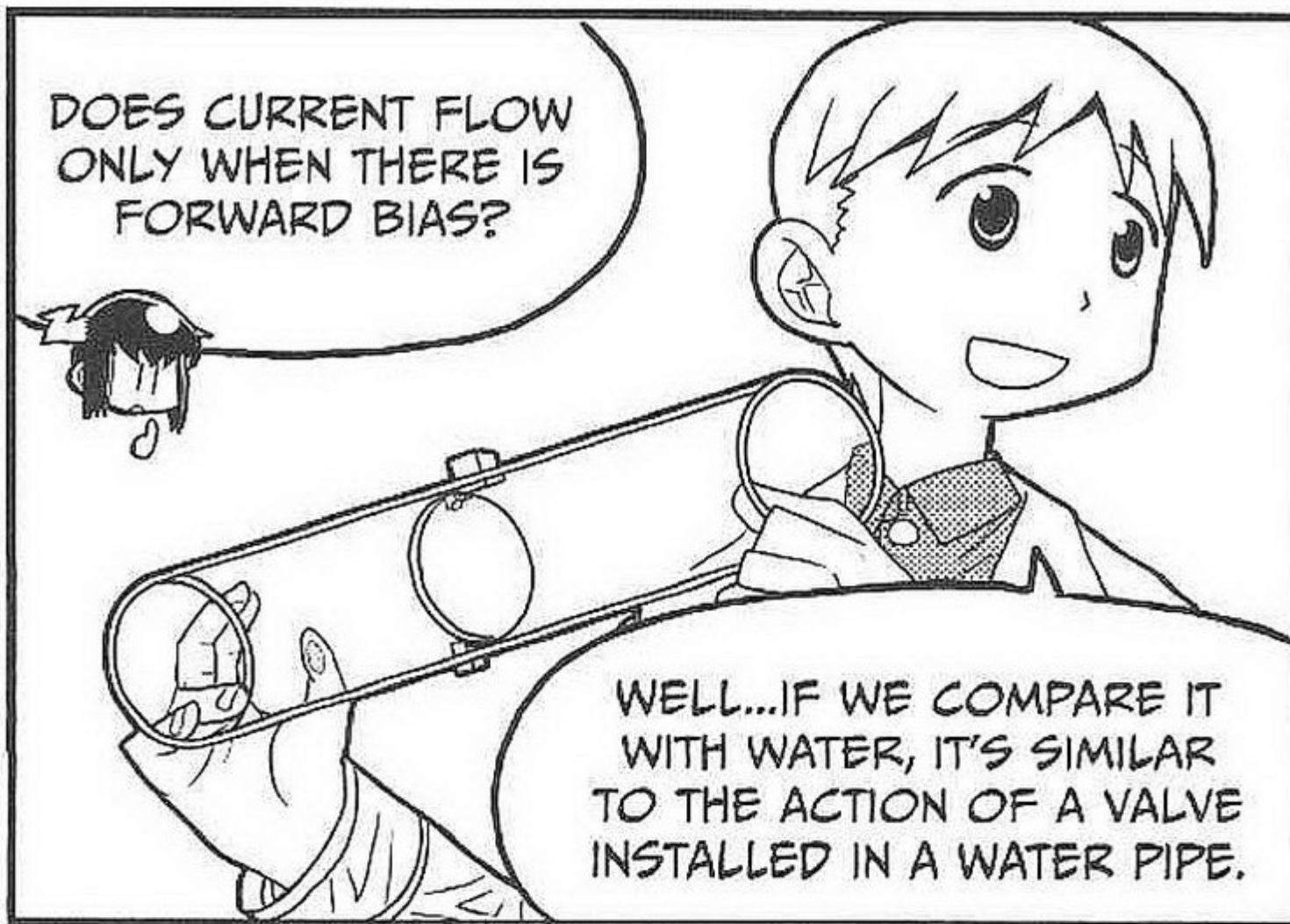

THE PROPERTY THAT ALLOWS CURRENT TO FLOW ONLY IN ONE DIRECTION IN THIS WAY IS CALLED RECTIFICATION.

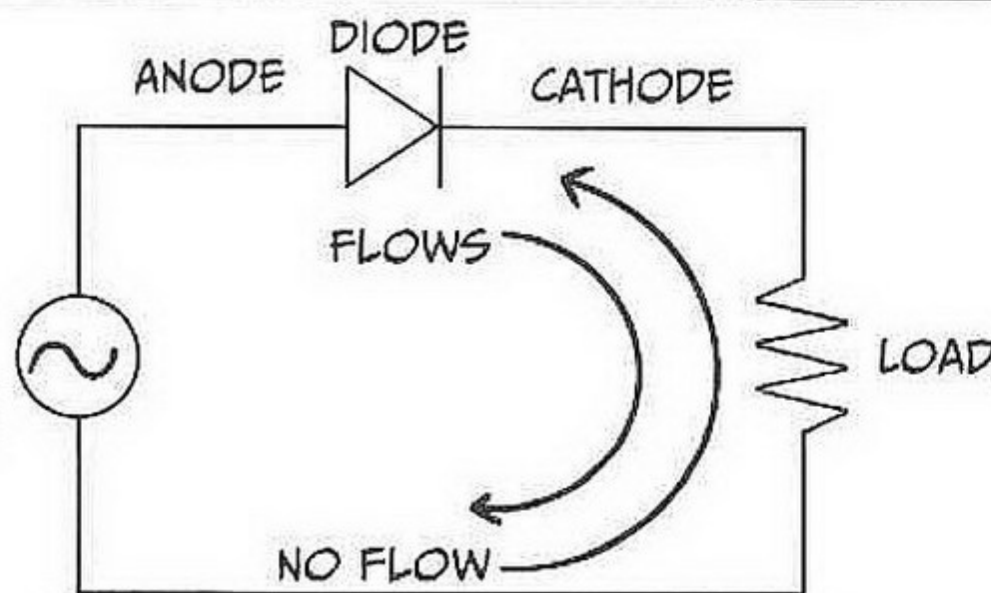
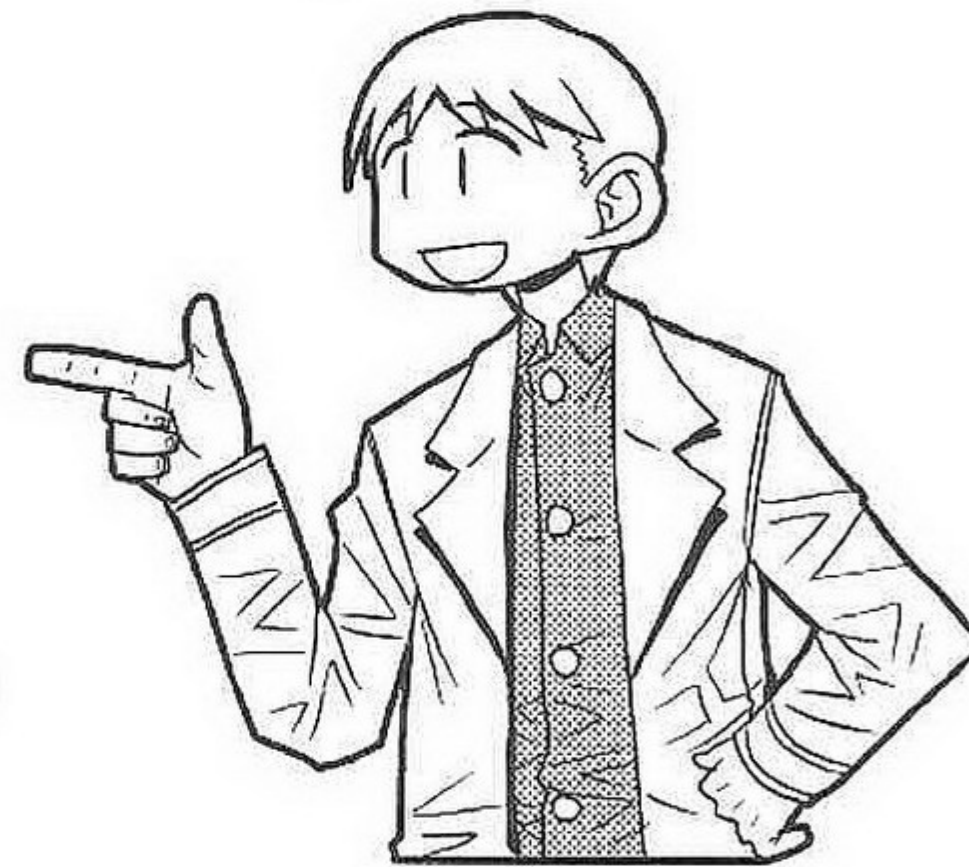

THE DIODE ONLY ALLOWS CURRENT FROM THE ANODE SIDE TO FLOW.



DIODES THAT EMIT LIGHT

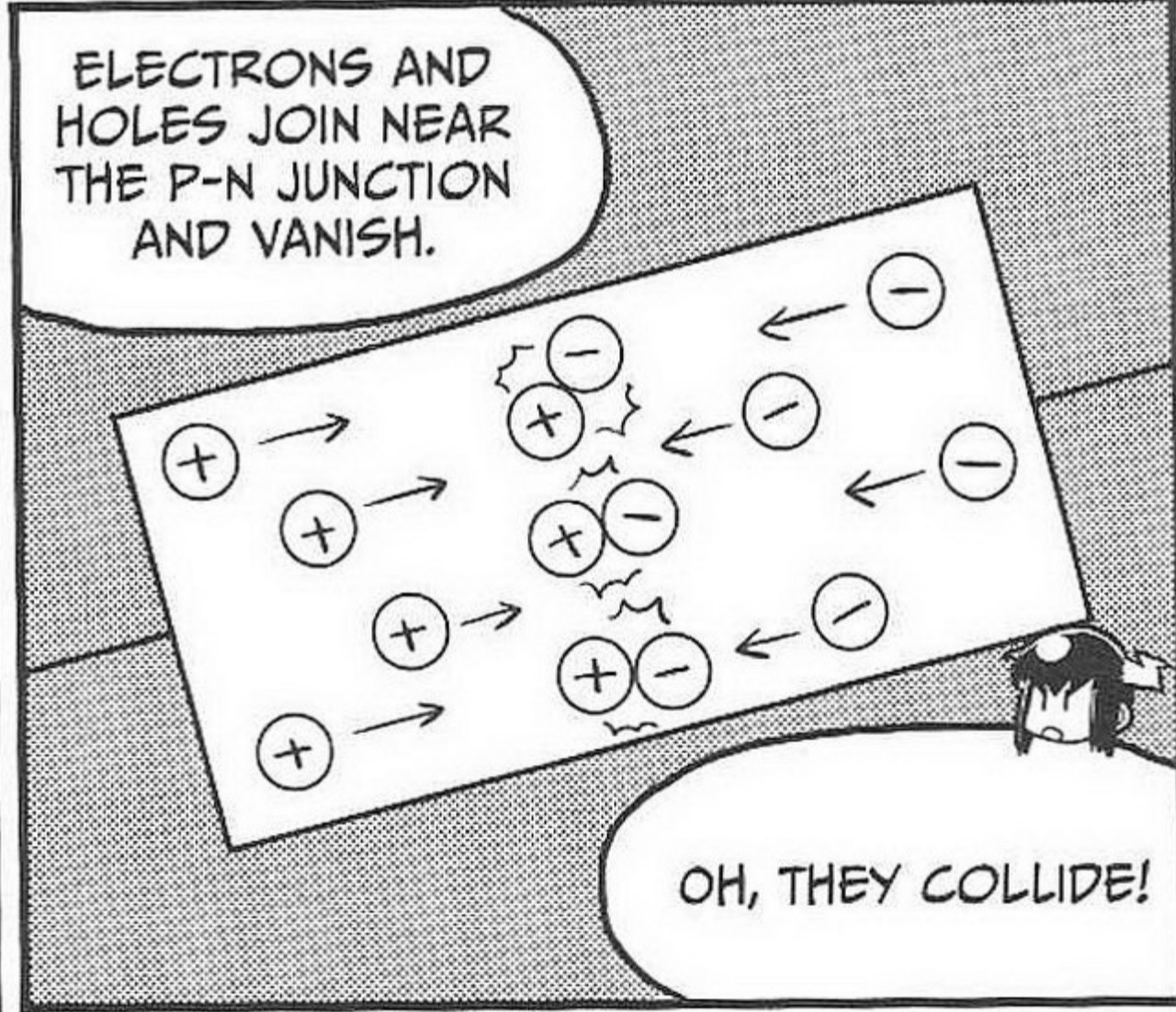
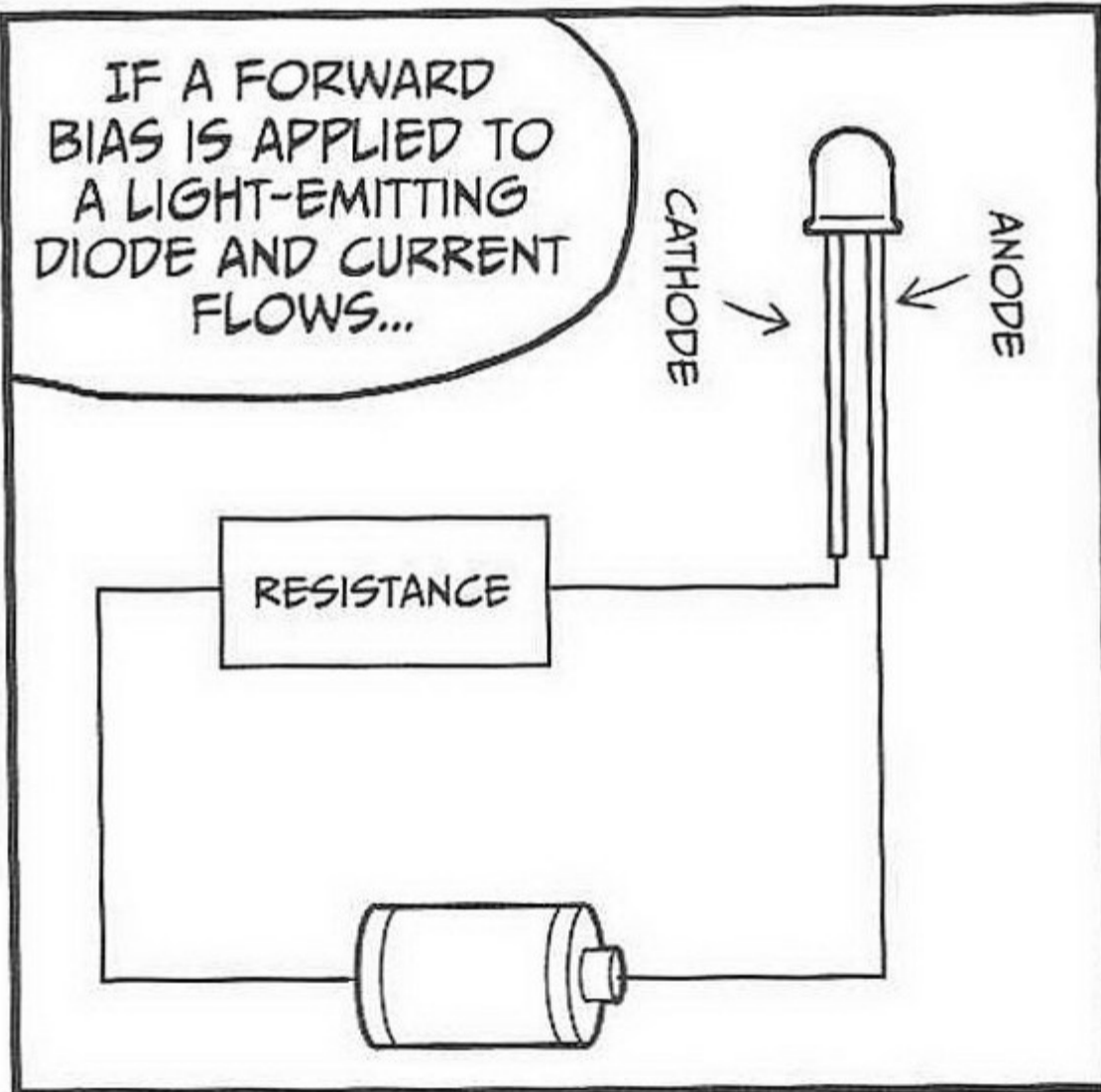
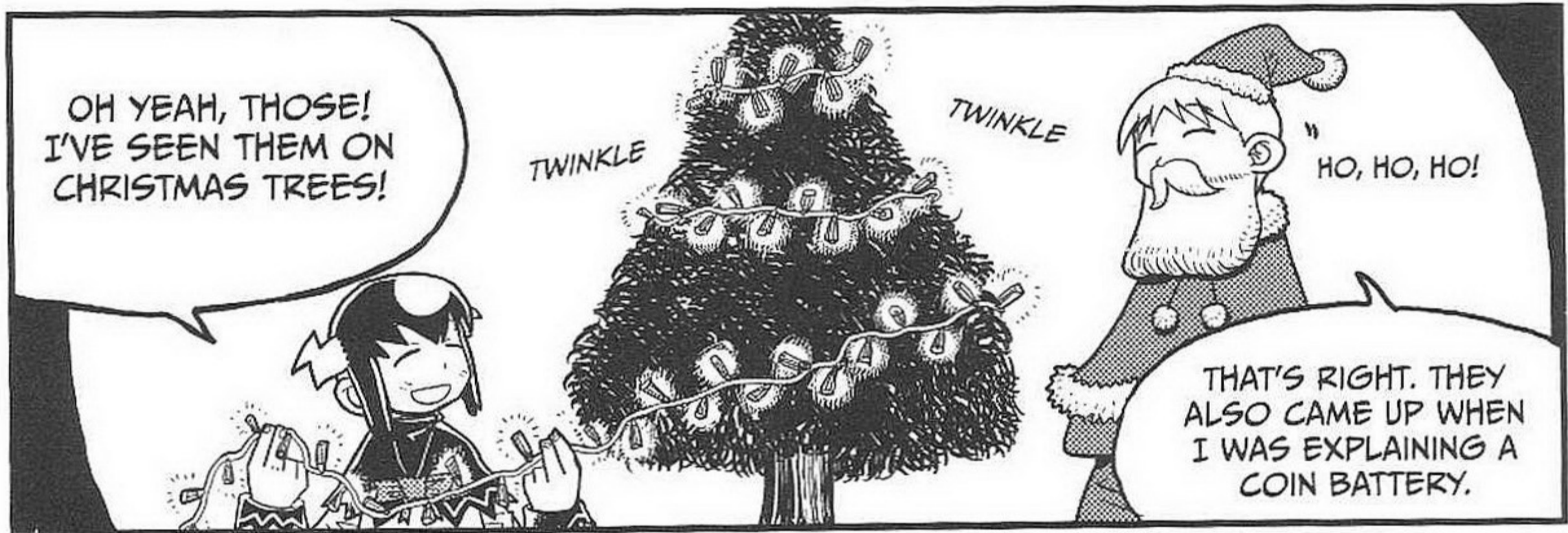
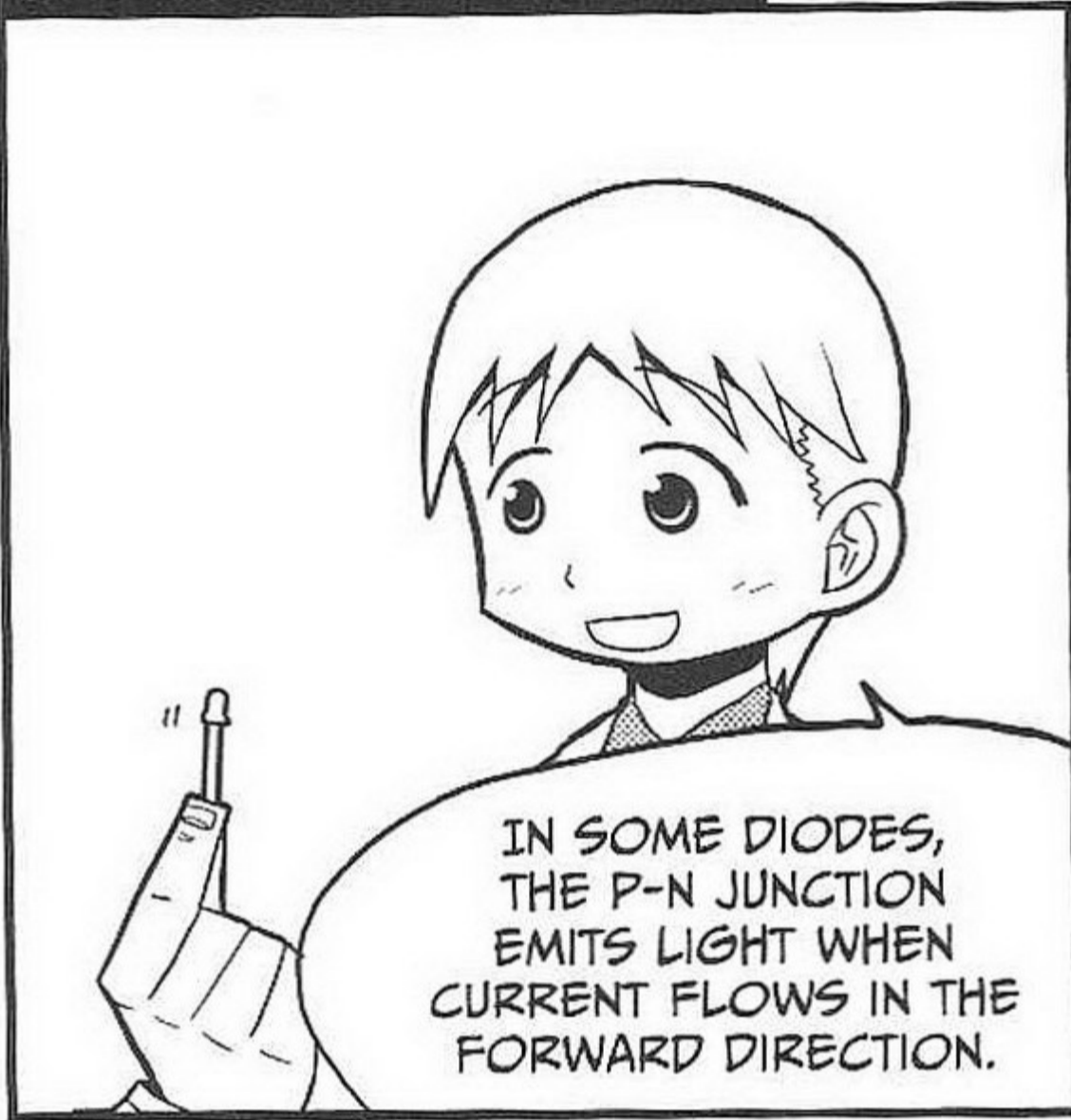

THE ENERGY THAT IS PRODUCED AT THAT TIME IS EMITTED AS LIGHT.

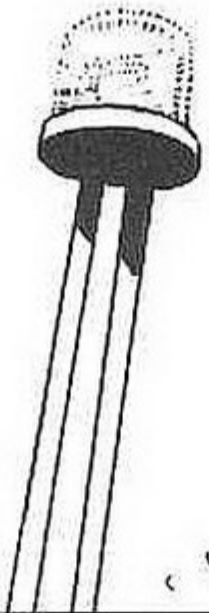

SINCE THE WAVELENGTH OF THE LIGHT EMITTED DEPENDS ON THE RAW MATERIAL OF THE SEMICONDUCTOR, VARIOUS COLORS OF LIGHT CAN BE CREATED.

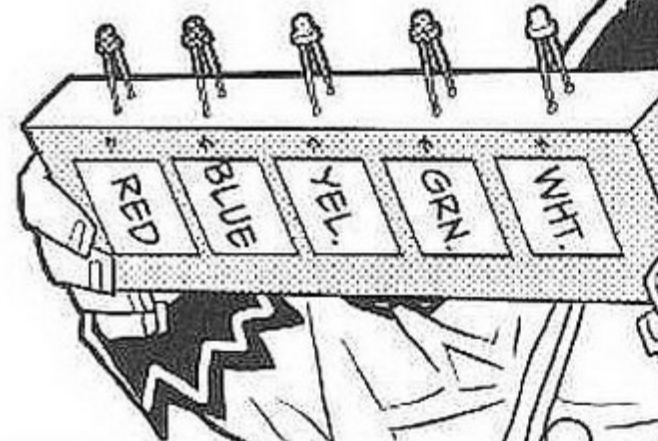

OOOH, AAAAAH.

TRAFFIC SIGNALS

LARGE-SCREEN OUTDOOR DISPLAYS

INTERIOR LIGHTS OF CARS

BACKLIGHTING OF MOBILE PHONES OR DIGITAL CAMERAS

SINCE THE LUMINESCENCE OF LIGHT-EMITTING DIODES DOES NOT INVOLVE HEAT, THEY ARE ENERGY EFFICIENT AND HAVE A LONG LIFETIME. THEREFORE, THEY ARE USED IN VARIOUS WAYS.

WE SURE SEE LOTS OF THEM IN OUR EVERYDAY LIVES.

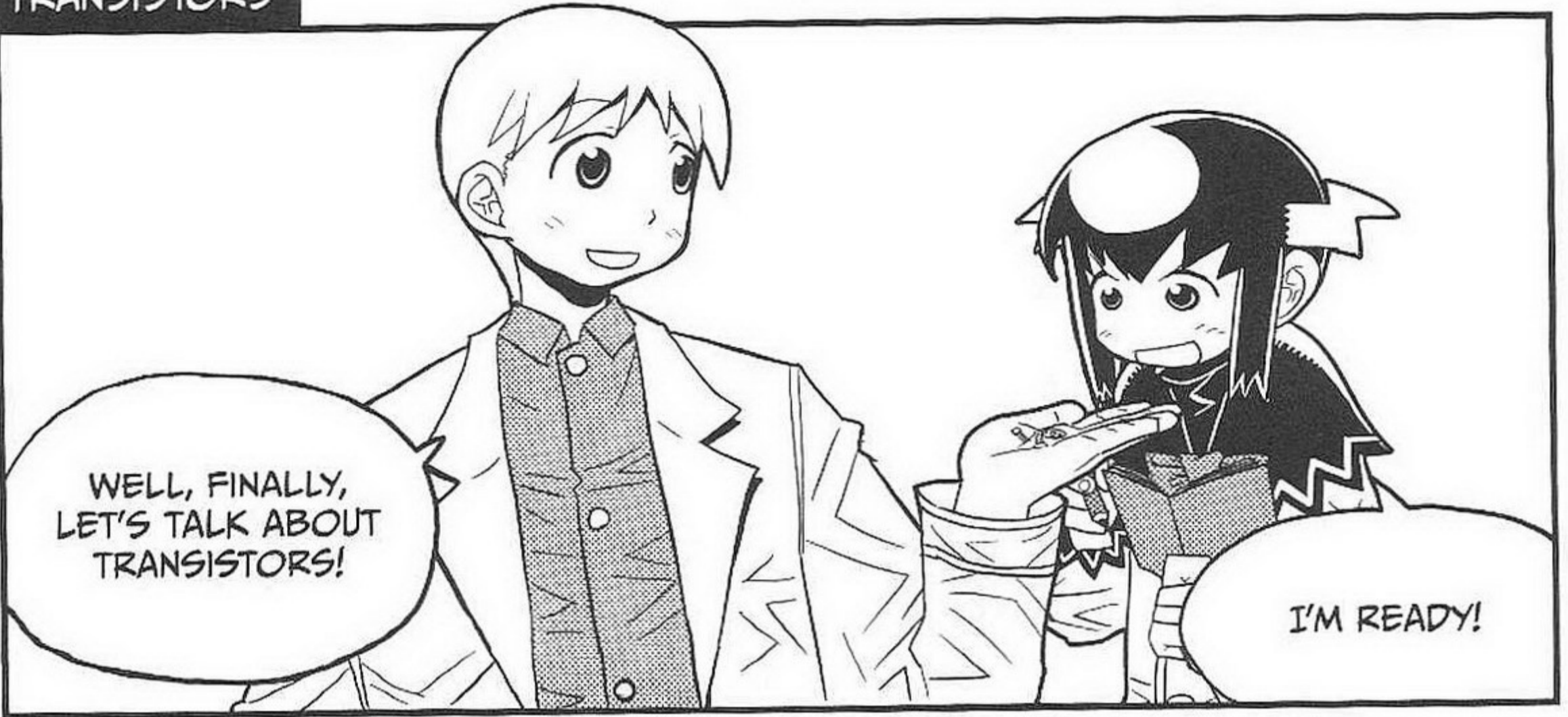

TRANSISTORS ARE SEMICONDUCTOR DEVICES THAT AMPLIFY SIGNALS OR ACT AS SWITCHES BY CONTROLLING THE CURRENT OR THE VOLTAGE THAT IS APPLIED TO AN ELECTRODE.

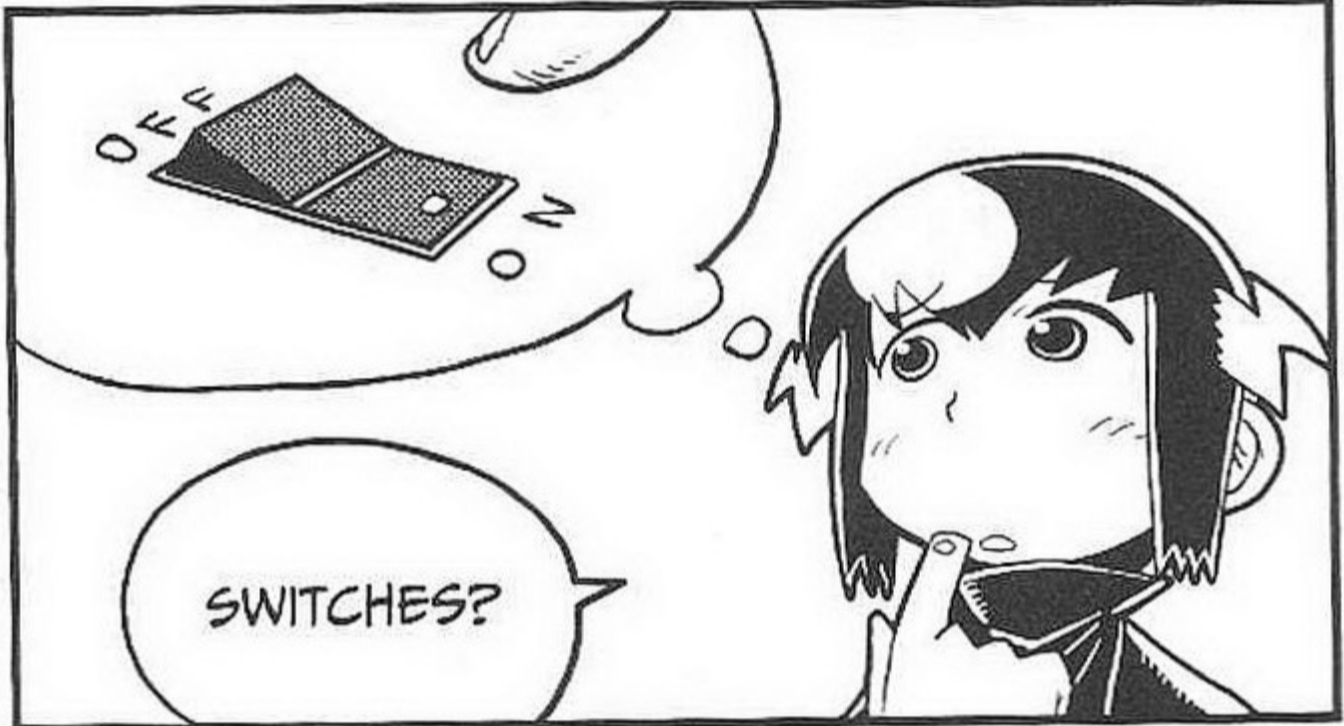
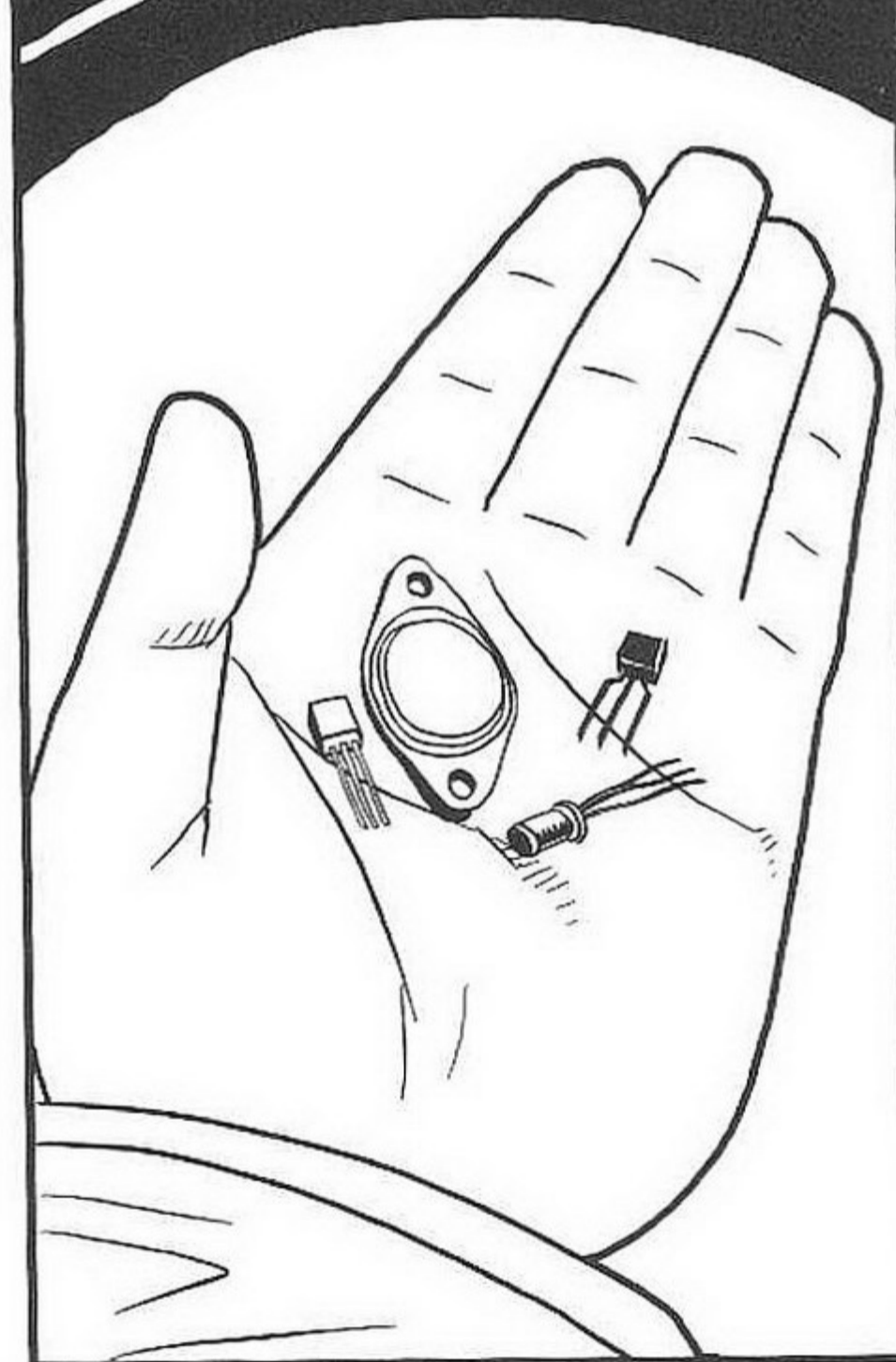

TWO TYPES OF TRANSISTORS ARE NPN AND PNP TRANSISTORS.

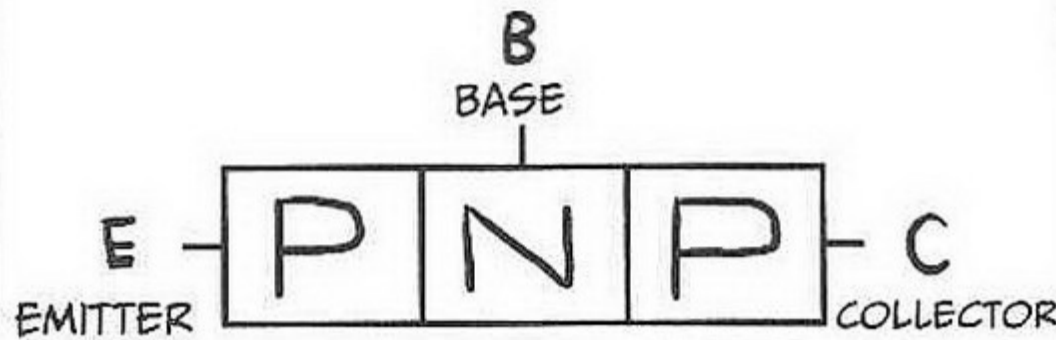
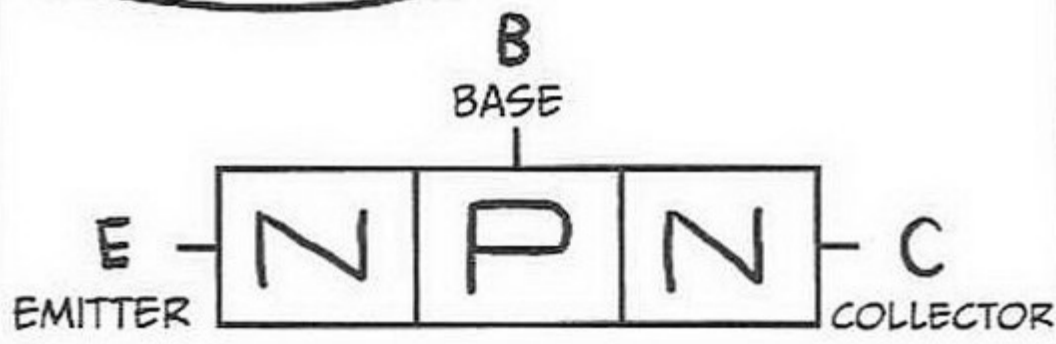

THEY HAVE THREE ELECTRODES REFERRED TO AS B (BASE), C (COLLECTOR), AND E (EMITTER).

THEY HAVE ONE MORE ELECTRODE THAN A DIODE!



IF AN NPN TRANSISTOR IS CONNECTED LIKE THIS...

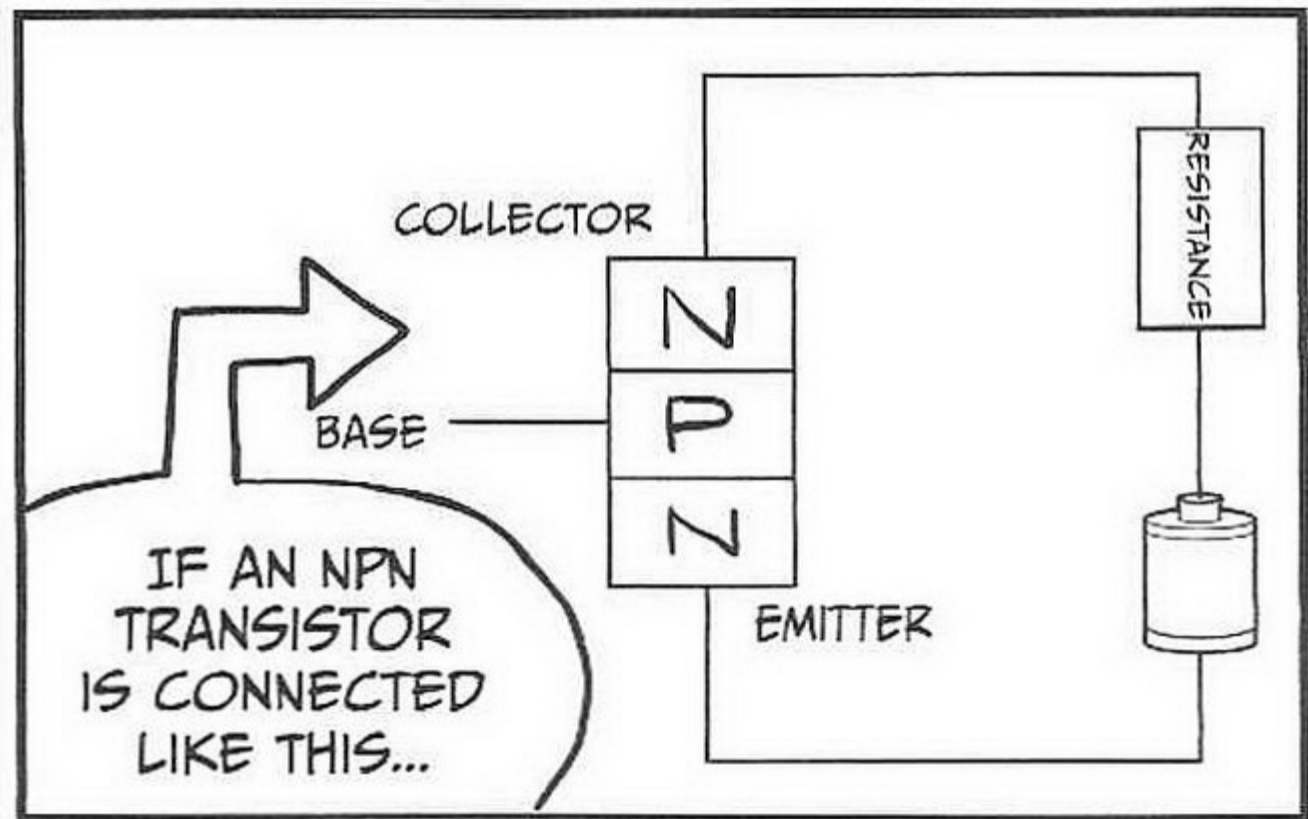

...THE ELECTRONS IN THE COLLECTOR ARE DRAWN TO THE POSITIVE POLE WHERE THEY ACCUMULATE.

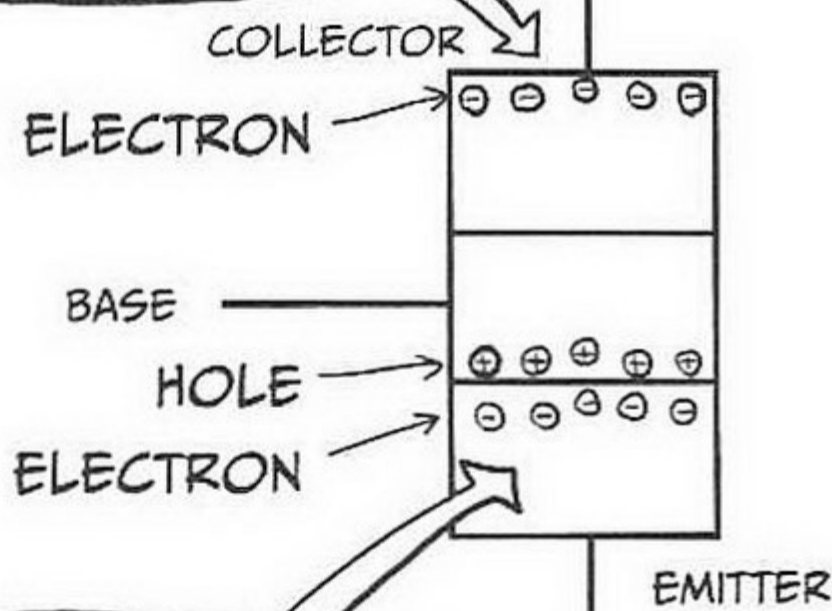

ON THE OTHER HAND, THE ELECTRONS IN THE EMITTER ARE PUSHED TO THE NEGATIVE POLE AND ACCUMULATE NEAR THE BASE-EMITTER JUNCTION INTERFACE.

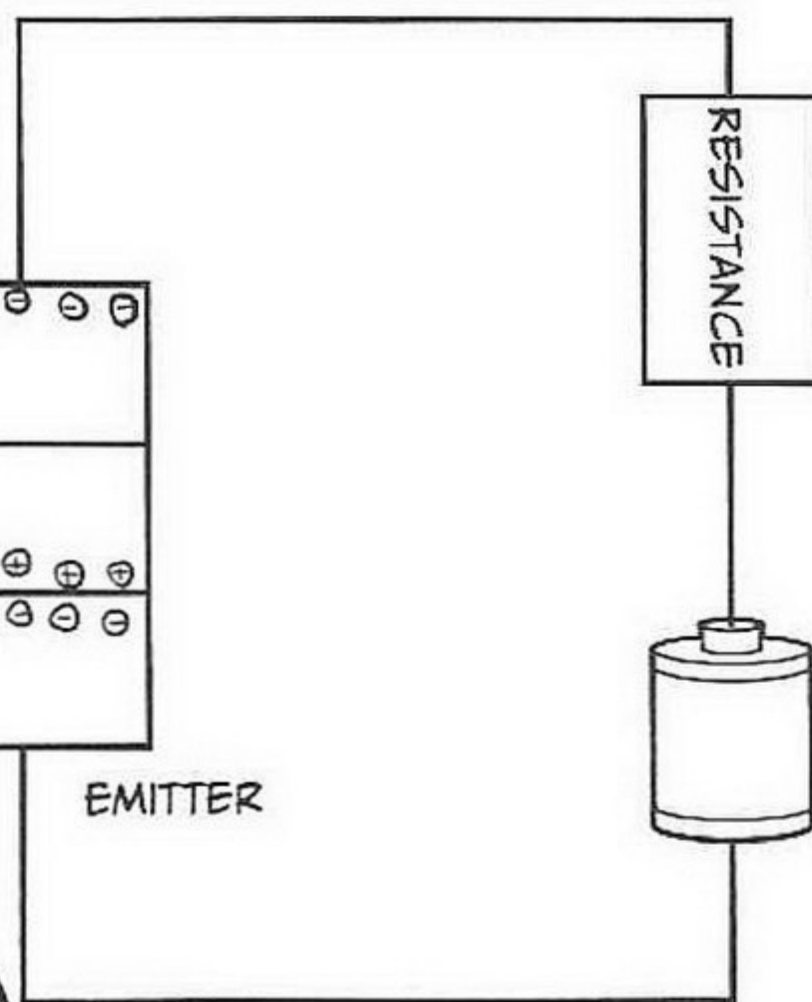

SCRIBBLE, SCRIBBLE

OKAY, GOT IT!



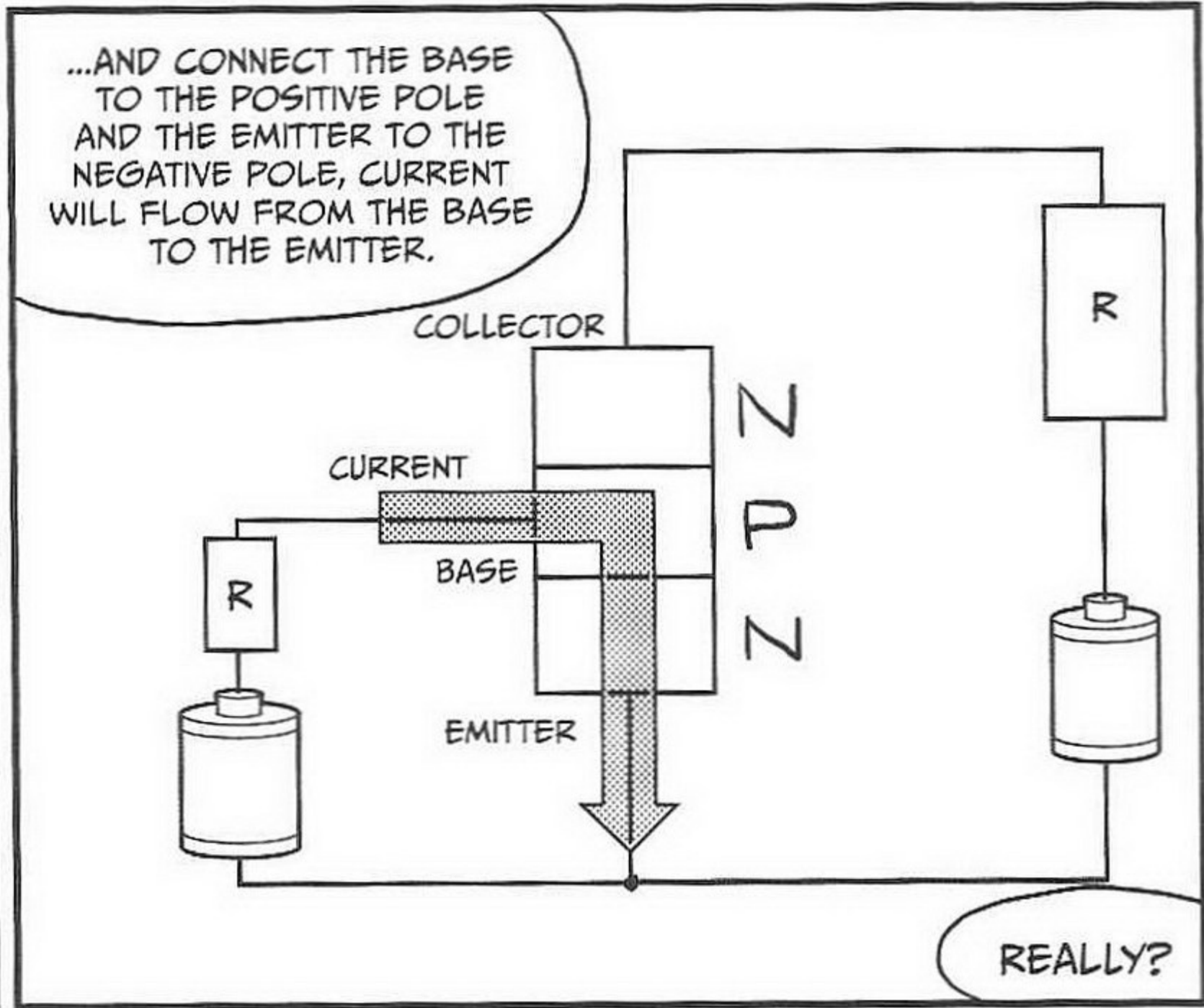
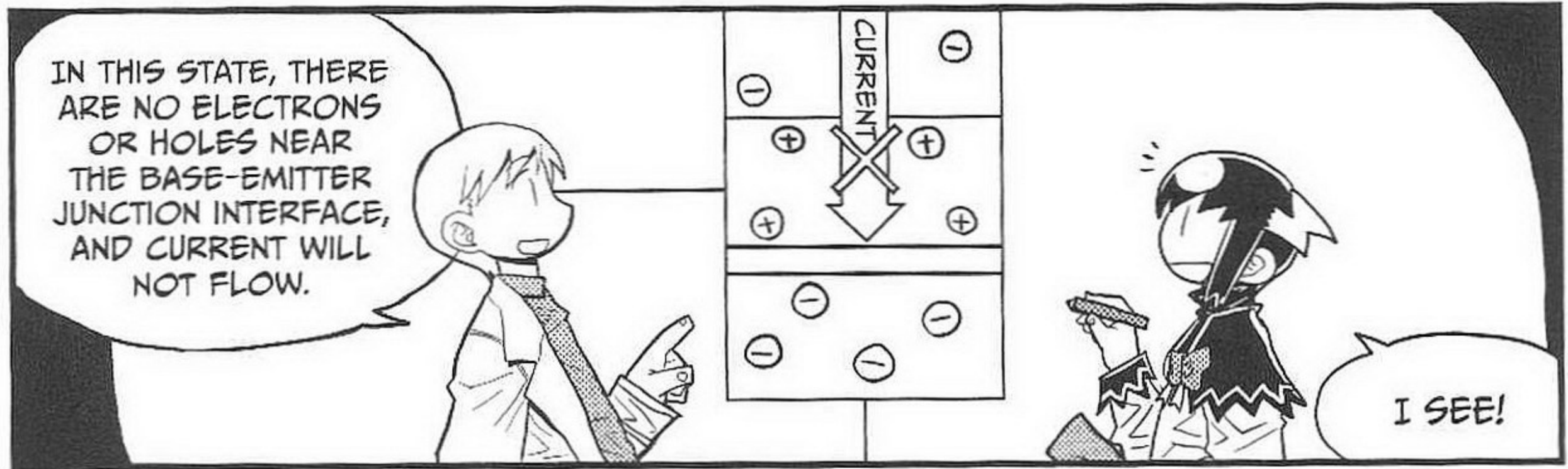
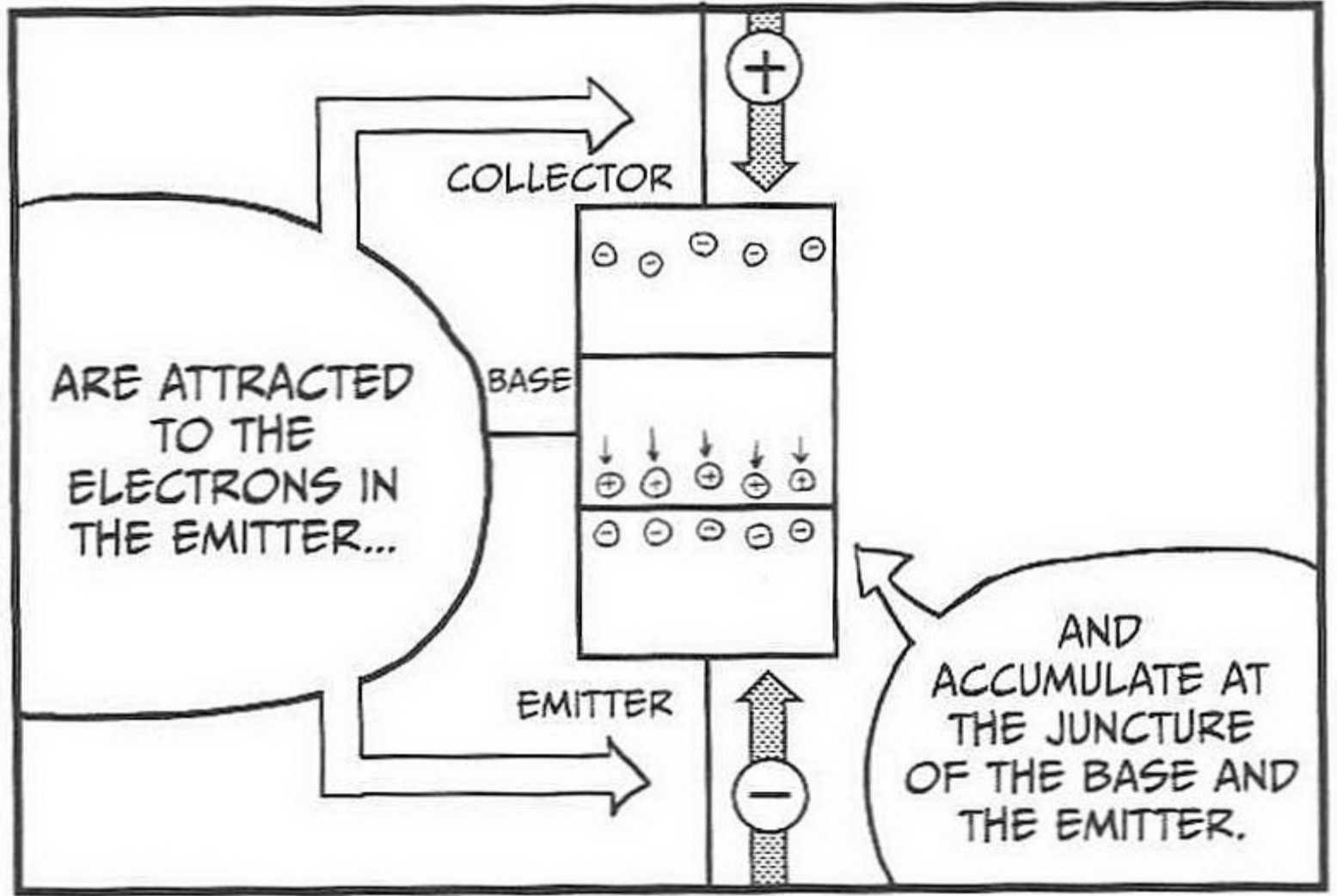
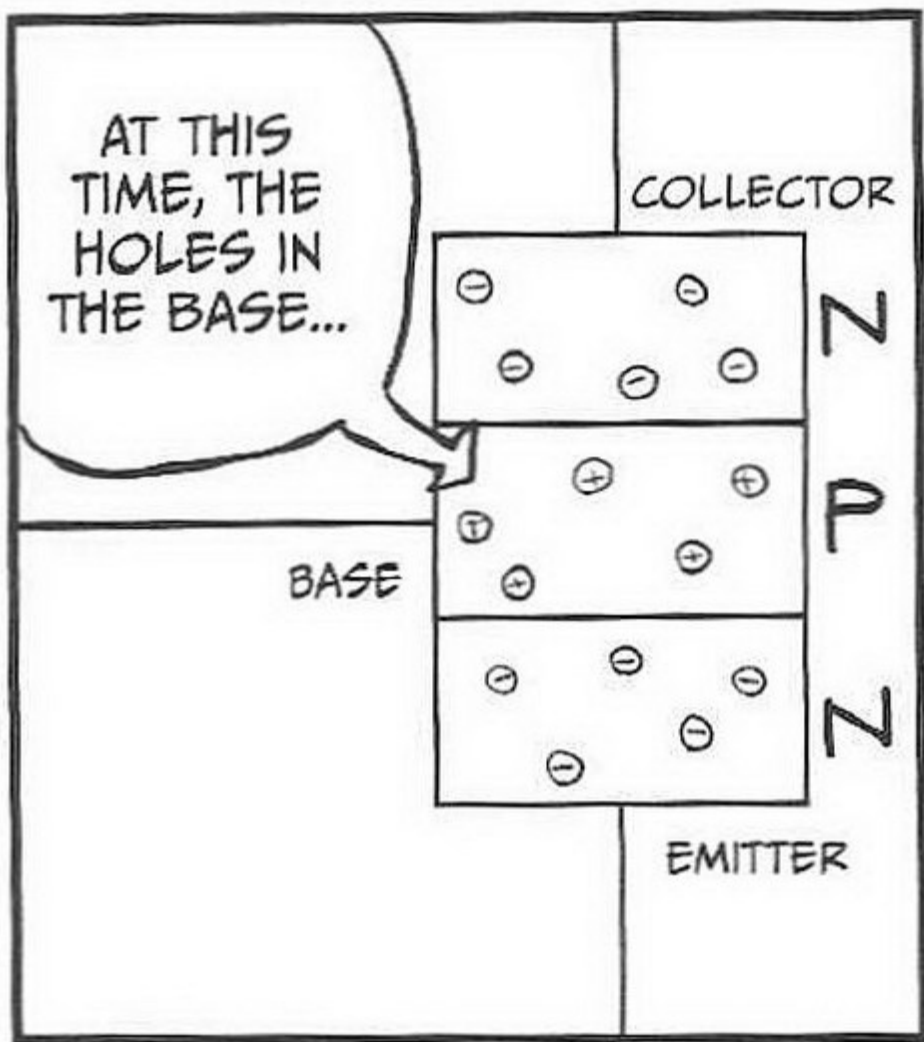

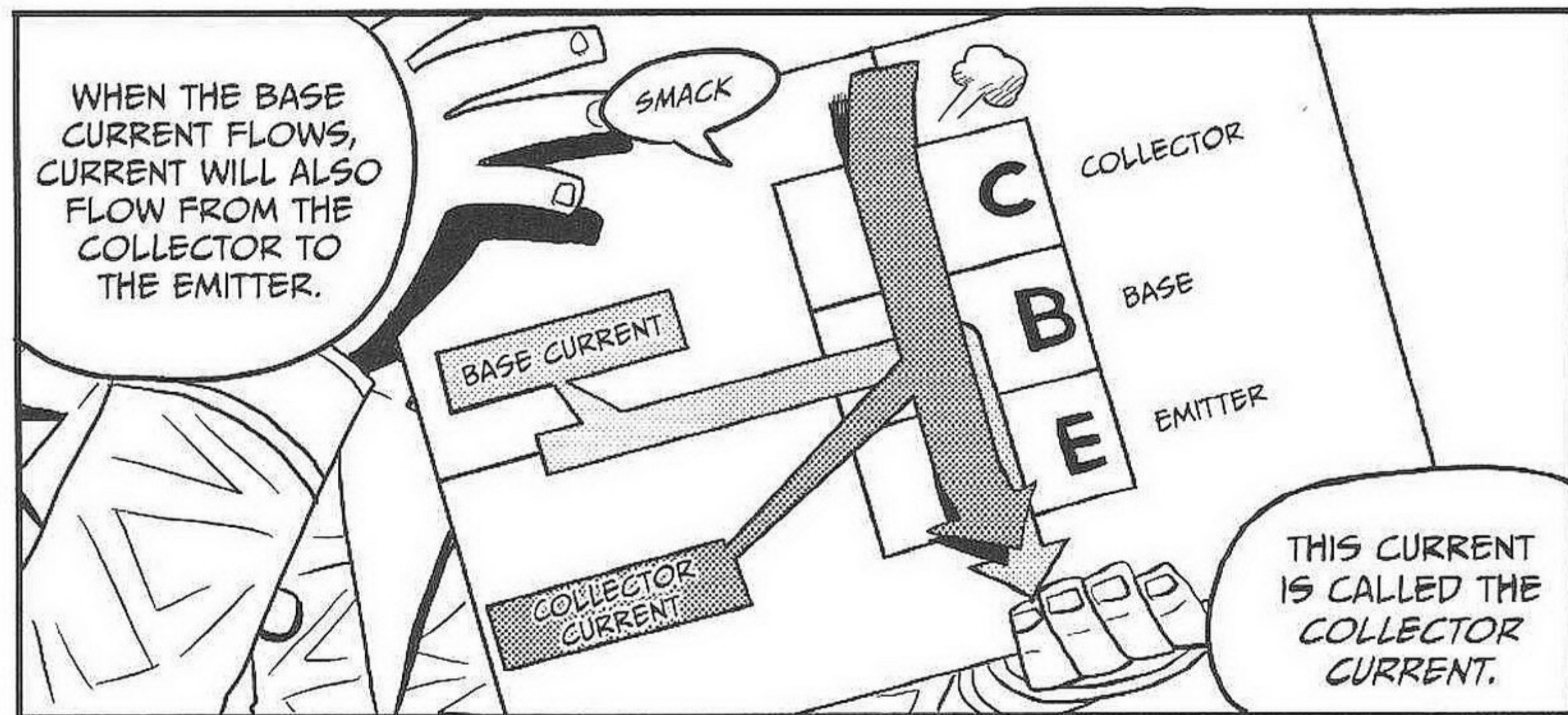
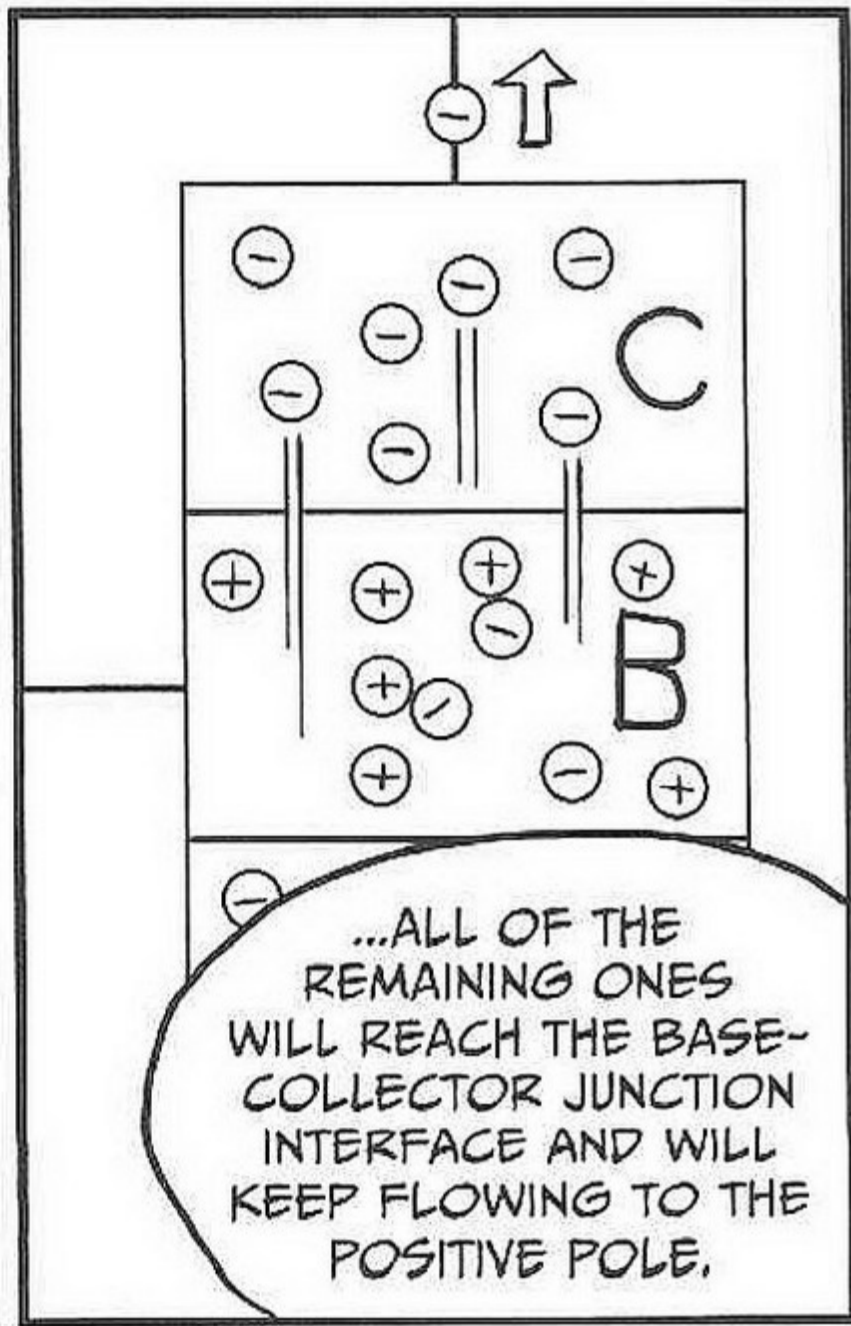
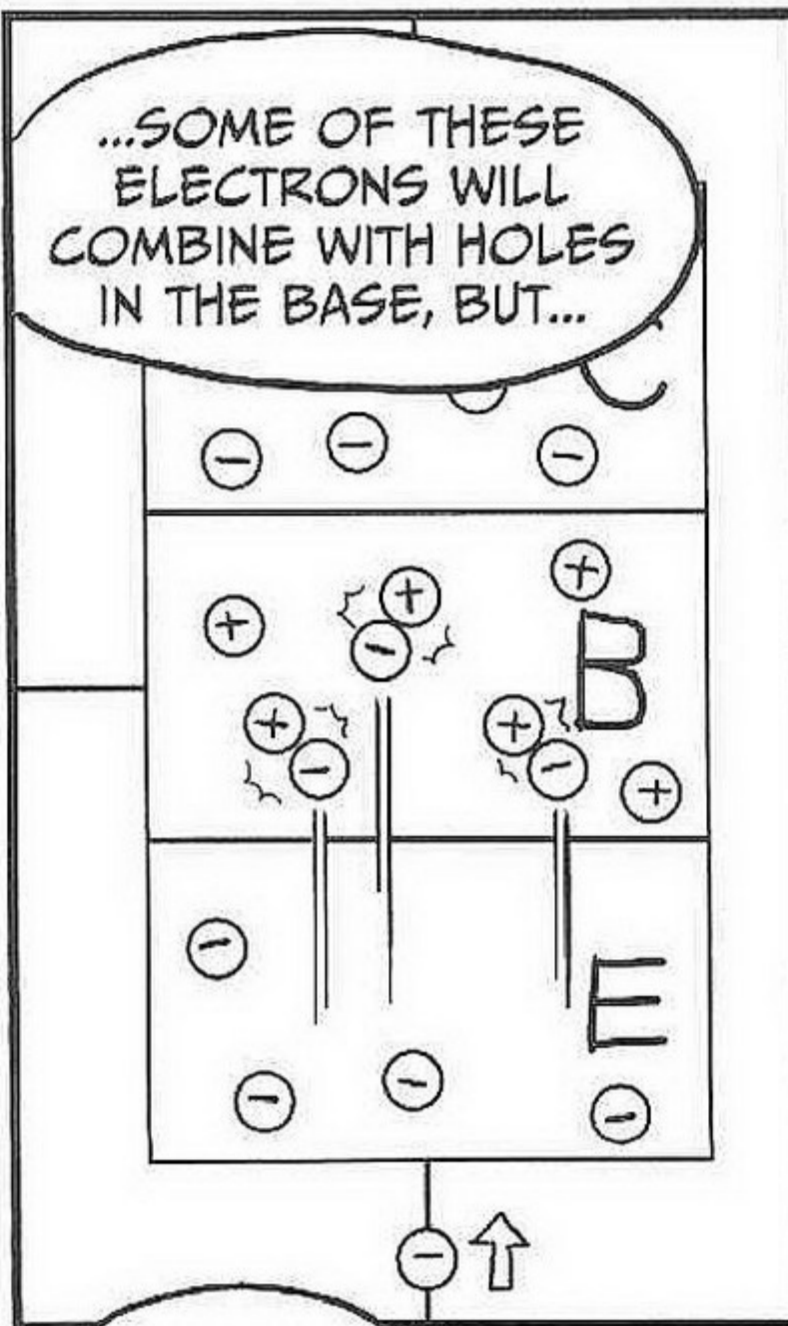
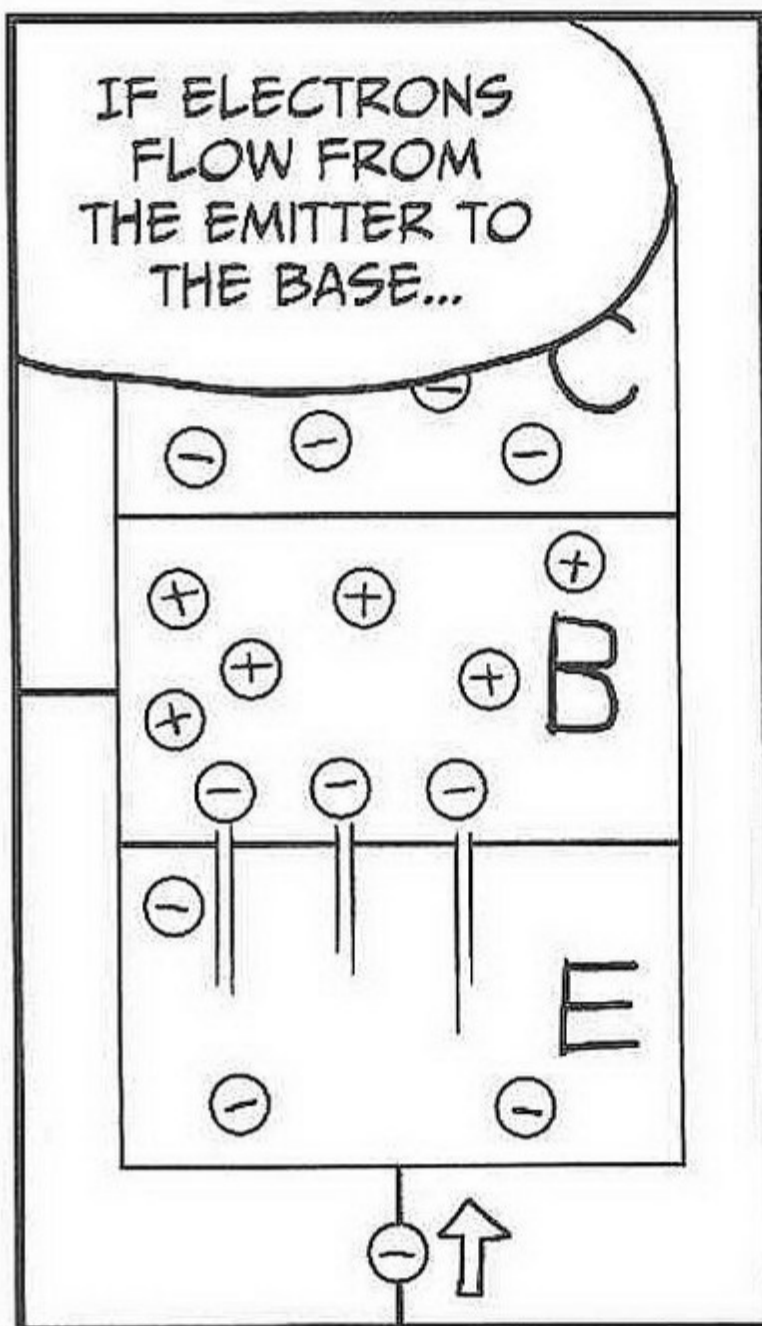

BASE CURRENT

COLLECTOR CURRENT

C COLLECTOR

B BASE

E EMITTER

WHEN THE BASE CURRENT FLOWS, THE COLLECTOR CURRENT WILL ALSO FLOW, RIGHT?

THAT'S RIGHT!

TRANSISTORS ENABLE THE COLLECTOR CURRENT TO BECOME MUCH GREATER THAN THE BASE CURRENT.

IS THAT SO?

BASE CURRENT

COLLECTOR CURRENT

AS A RESULT, THE COLLECTOR CURRENT WILL CHANGE SIGNIFICANTLY IN RESPONSE TO A SLIGHT CHANGE IN THE BASE CURRENT.

SO THE BASE CURRENT CAN BE USED TO ADJUST THE COLLECTOR CURRENT?

EXACTLY.

TANK (SMALL)

TANK (LARGE)

FAUCET

RECEPTACLE

VALVE

WATER WHEEL

WE CAN ILLUSTRATE THIS CONCEPT IN TERMS OF WATER LIKE THIS.

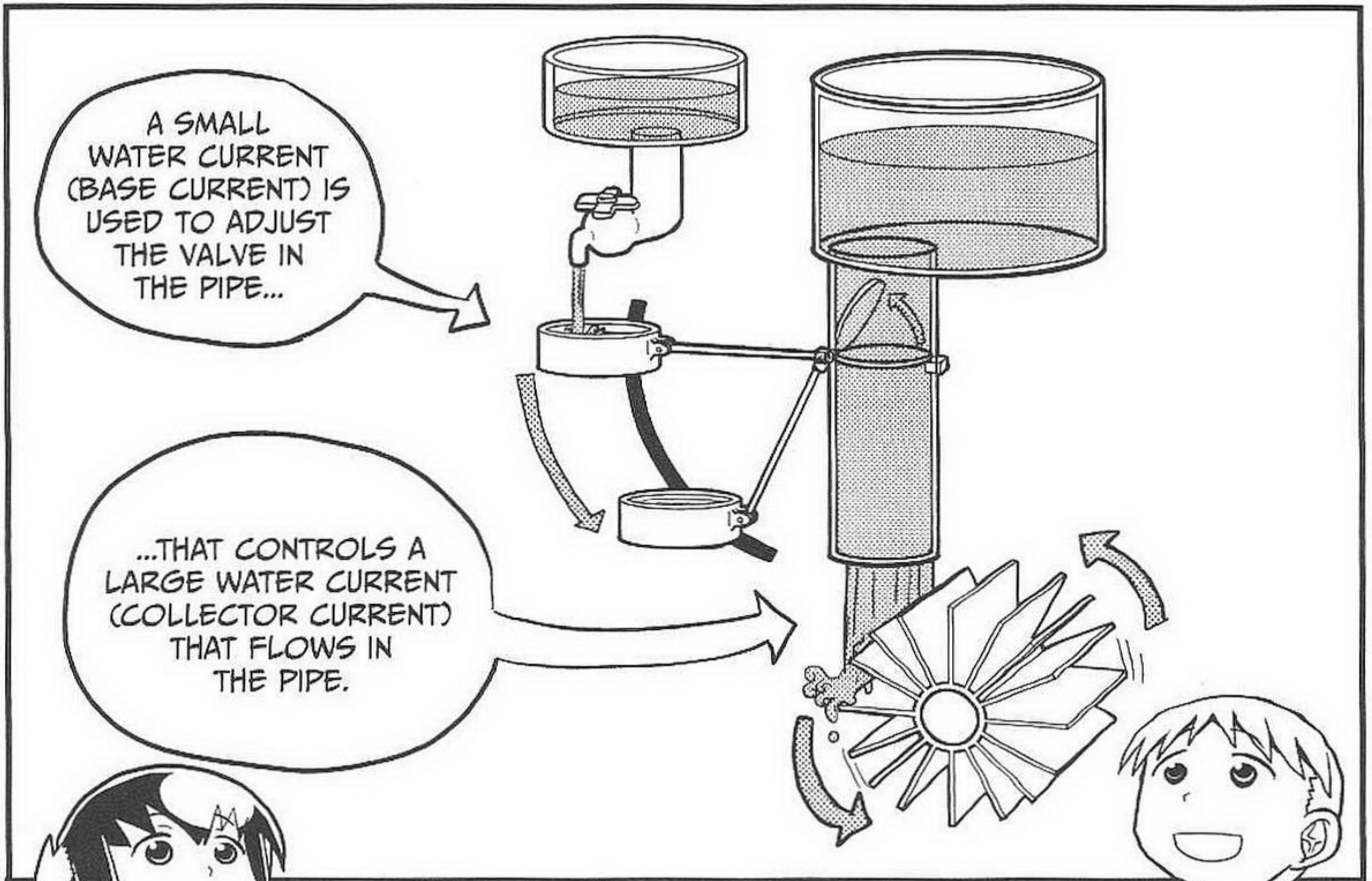

I SEE!

THIS IS HOW TRANSISTOR AMPLIFICATION WORKS.

ALTHOUGH THE FLOW OF ELECTRICAL CURRENT IS THE OPPOSITE IN A PNP TRANSISTOR, THE BASIC OPERATION IS THE SAME.

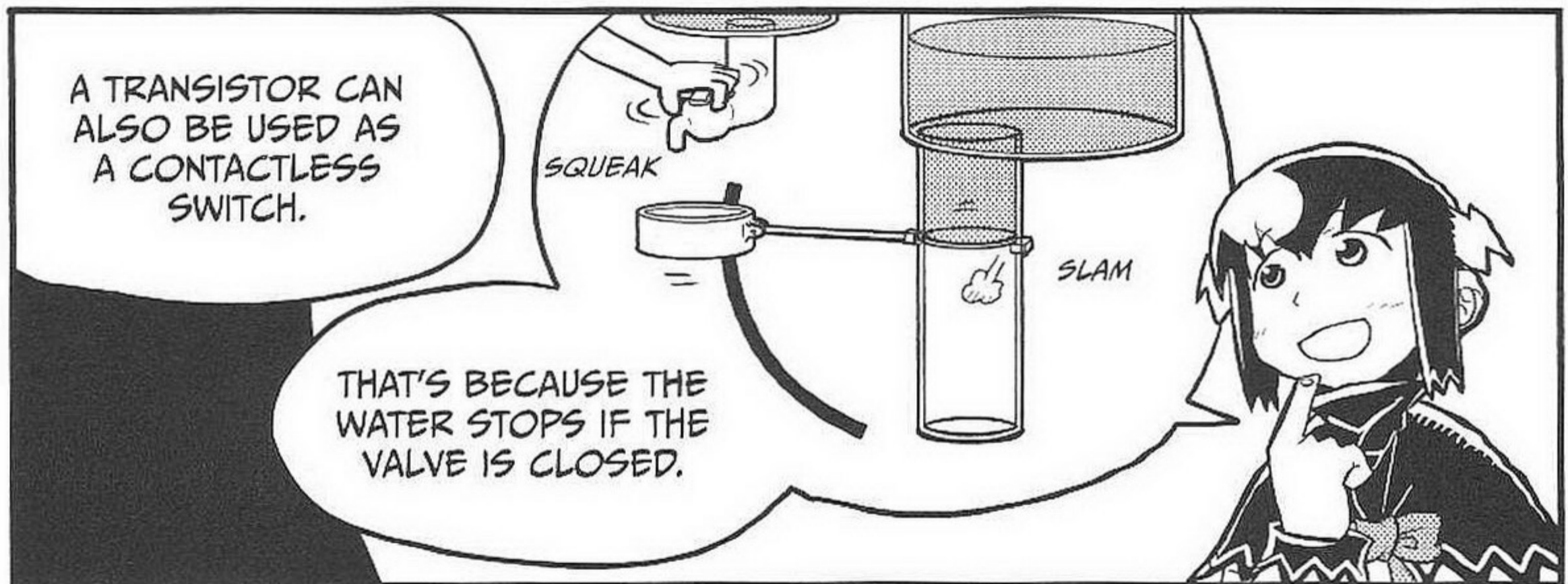

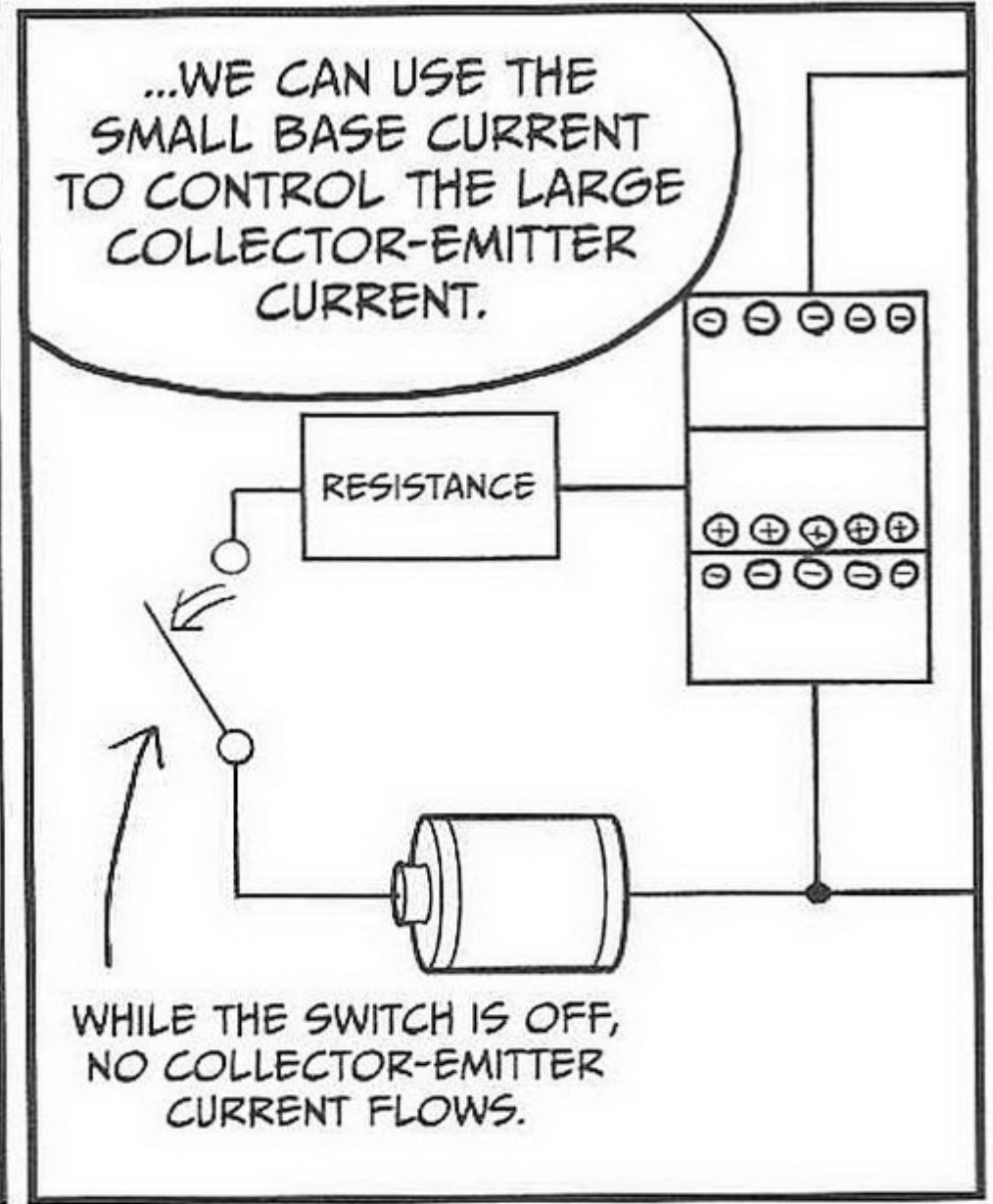
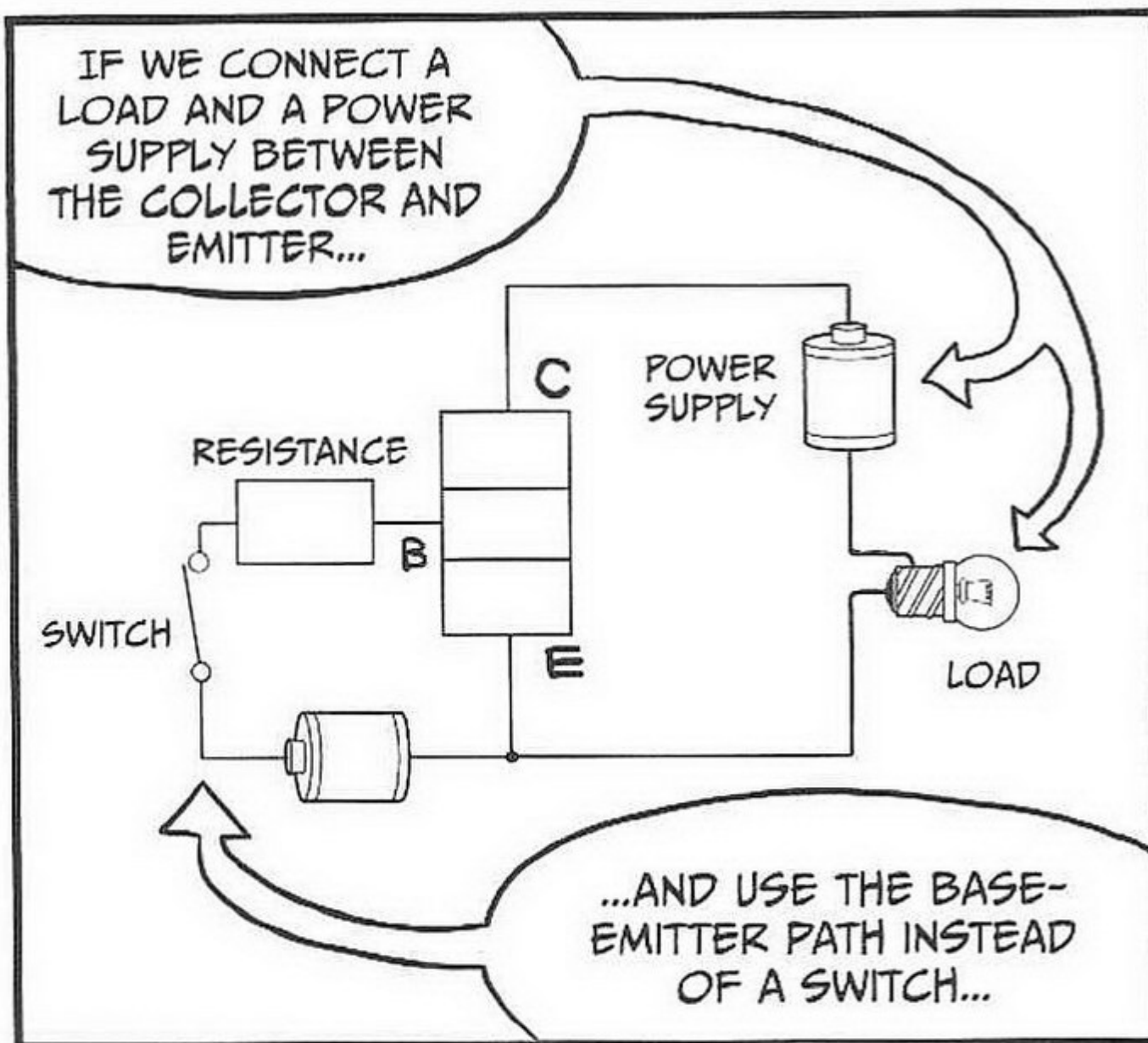

COMPONENTS CALLED INTEGRATED CIRCUITS (ICs) ARE ALSO USED IN ELECTRONIC DEVICES SUCH AS TVs OR COMPUTERS.

AN IC CONTAINS AN EXTREMELY LARGE NUMBER OF ELEMENTS SUCH AS TRANSISTORS, DIODES, RESISTORS, AND CAPACITORS—THESE COMPLICATED CIRCUITS CAN PERFORM DIGITAL LOGIC.

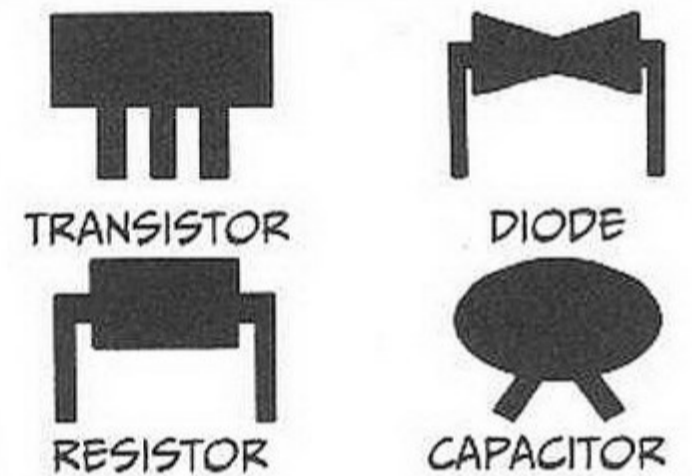

HMMMM...

WELL, THIS COMPLETES OUR DISCUSSION OF THE BASICS OF SEMICONDUCTOR DEVICES...

CLAP CLAP

...WHICH MEANS...

YOUR STUDIES ARE OVER! THANK YOU FOR ALL YOUR HARD WORK!

NO WAY!
IT'S YOU WHO DESERVES ALL THE THANKS. THANK YOU VERY, VERY MUCH!!

SINCE THE CALL FOR PICKING YOU UP HASN'T COME YET, LET'S GO FOR A LITTLE STROLL!

REALLY!?
THAT WOULD BE AWESOME!!



WHERE SHOULD WE GO...??

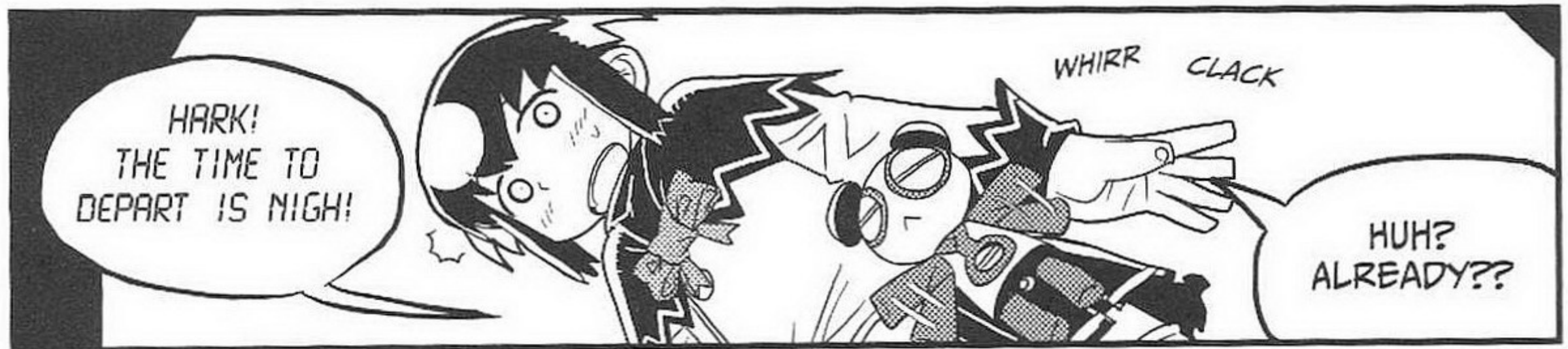

HARK!
THE TIME TO
DEPART IS NIGH!

WHIRR CLACK

HUH?
ALREADY??



BUT IT'S...
IT'S TOO...

YOU DON'T HAVE A
CHOICE, RIGHT...?

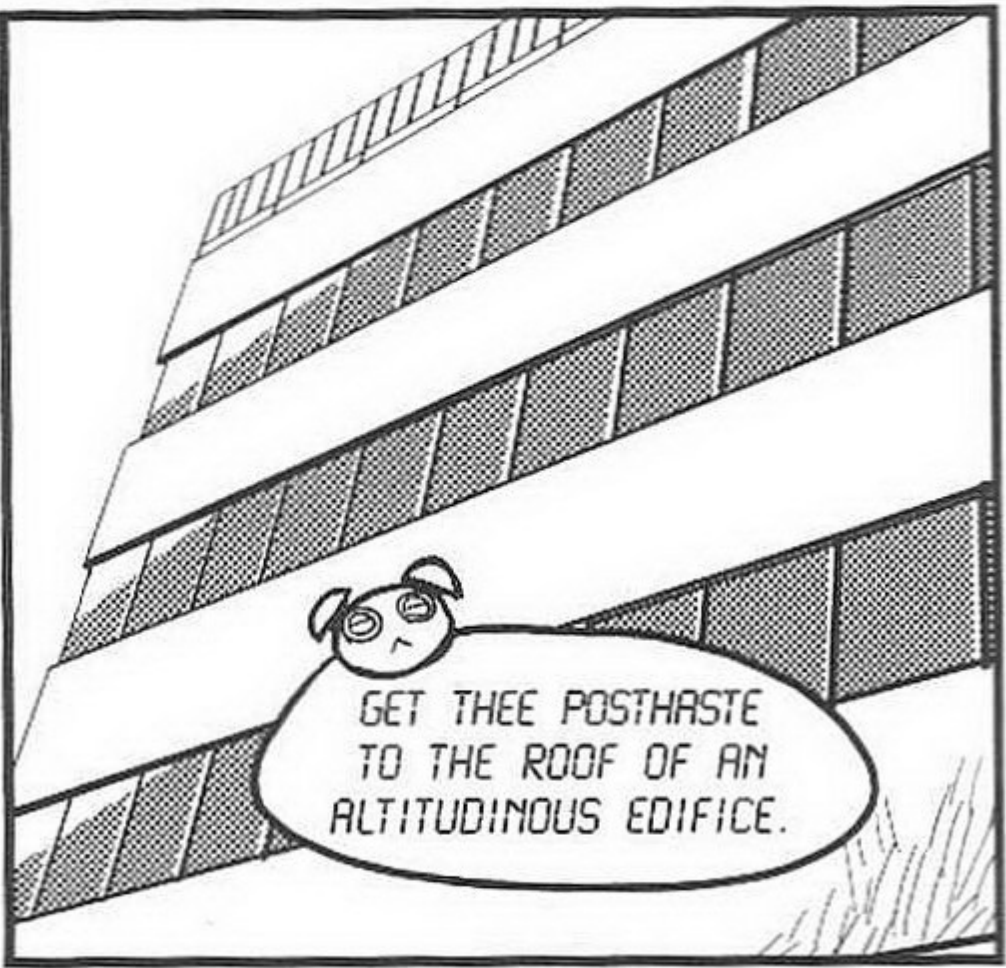

GET THEE POSTHASTE
TO THE ROOF OF AN
ALTITUDINOUS EDIFICE.

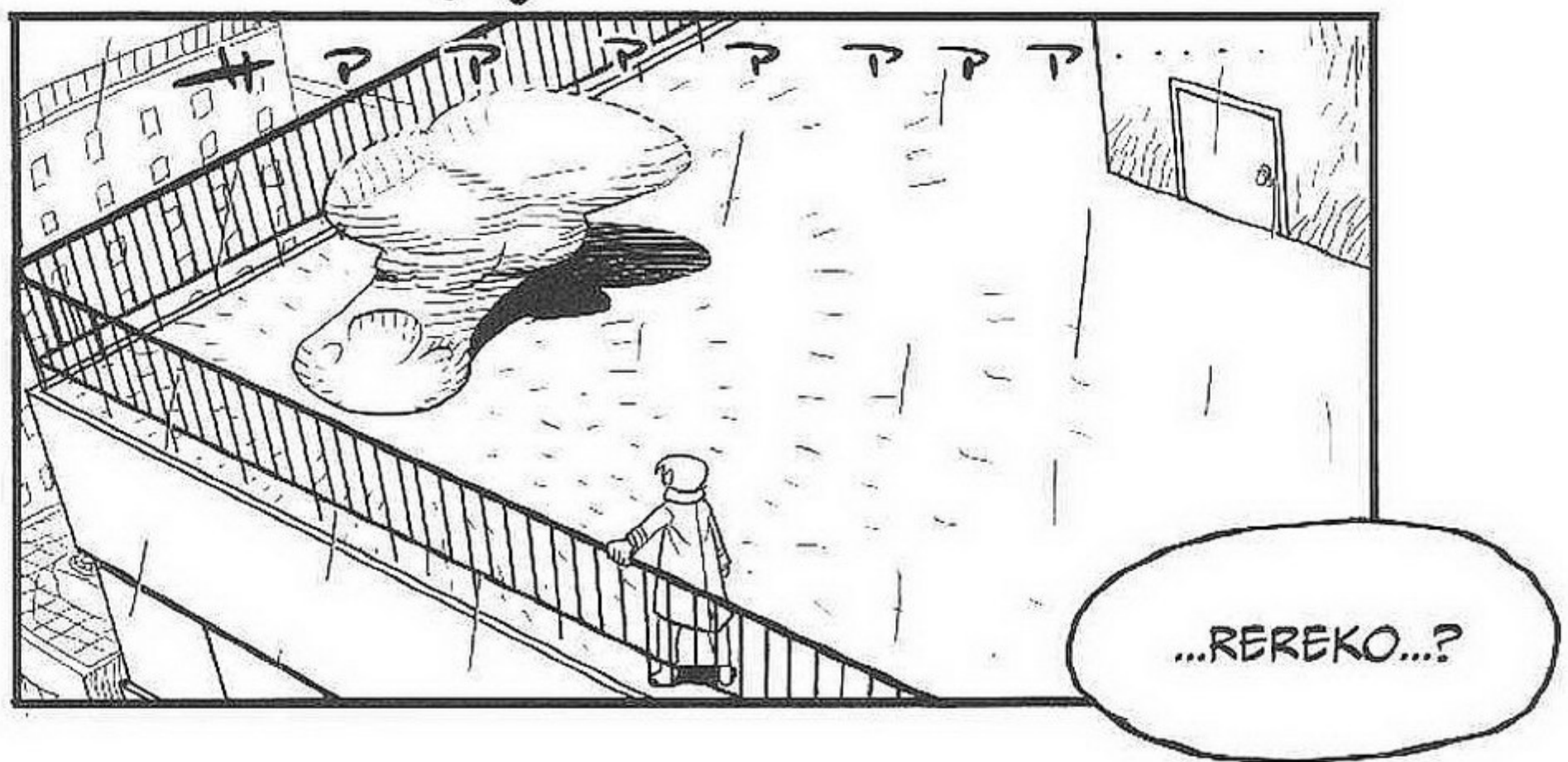
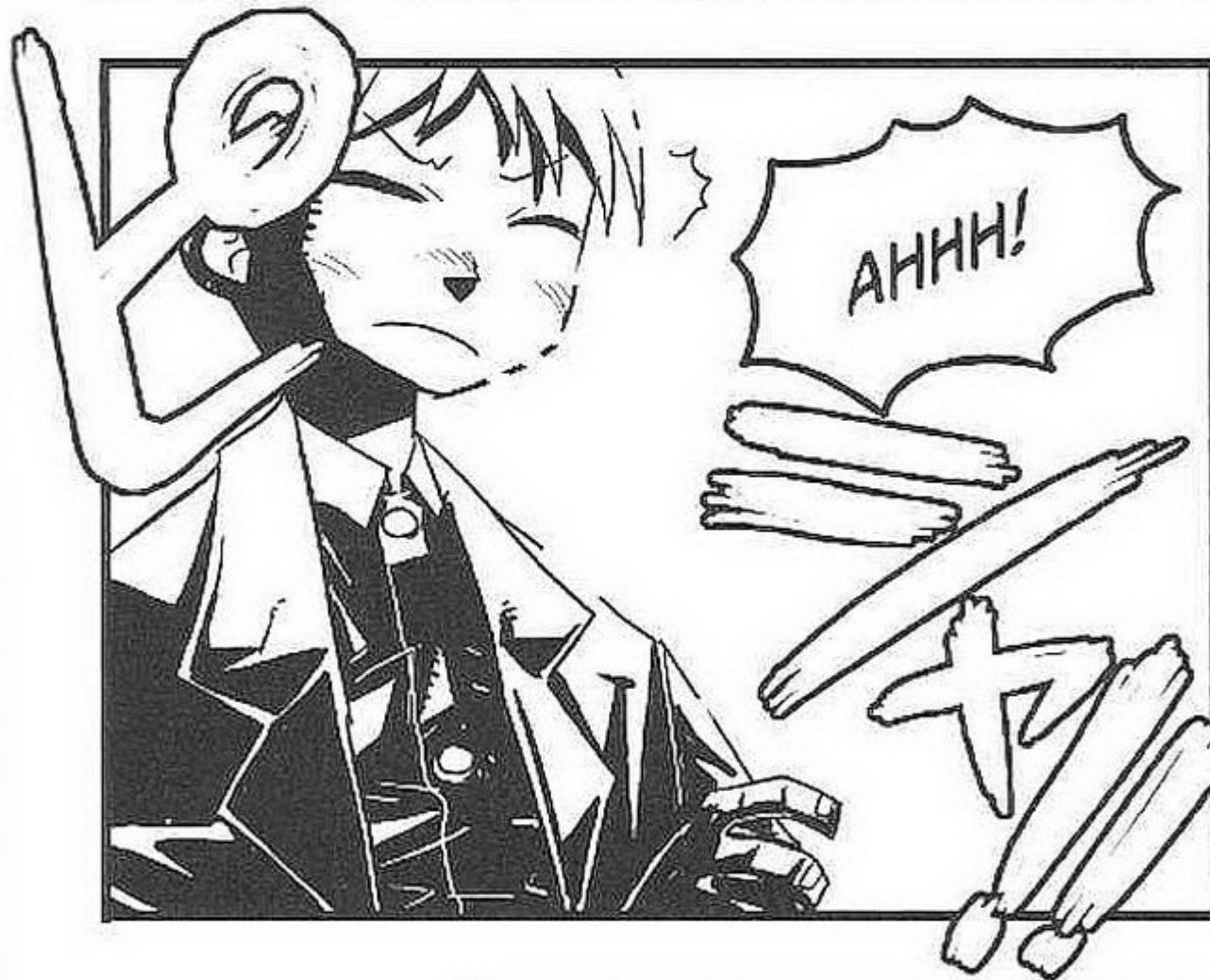
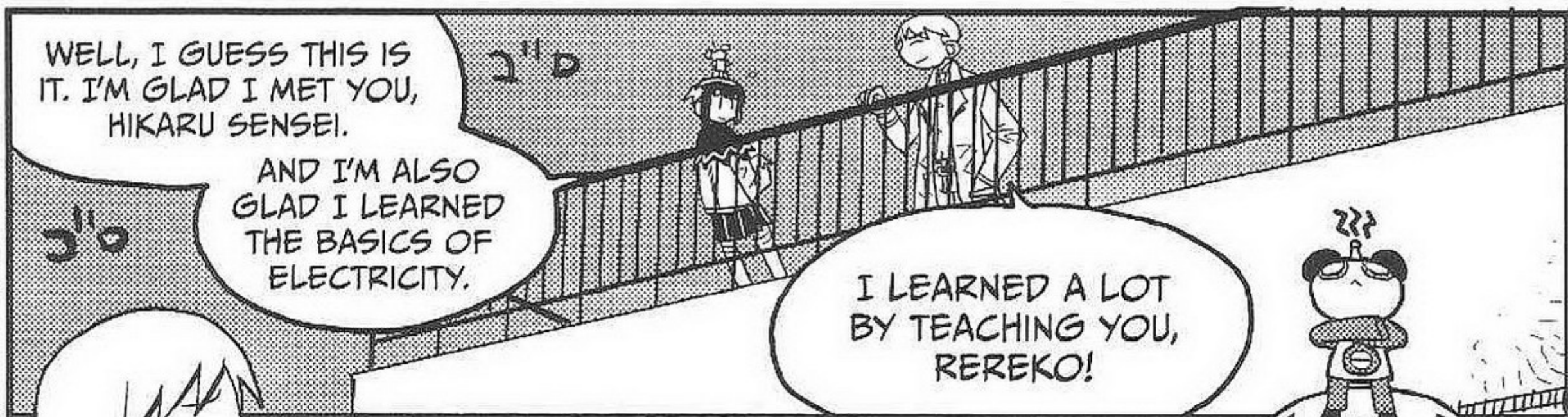

DIODES

When a single diode is connected to an AC power supply, current flows to the load for only one direction of the AC power supply due to rectification. Rectification that only allows a half-cycle of the alternating current to flow is called *half-wave rectification*, and the current that flows to the load in this process flows in only one direction, just like a direct current power supply. But since only a half-cycle of the AC waveform flows, this kind of rectification is inefficient.

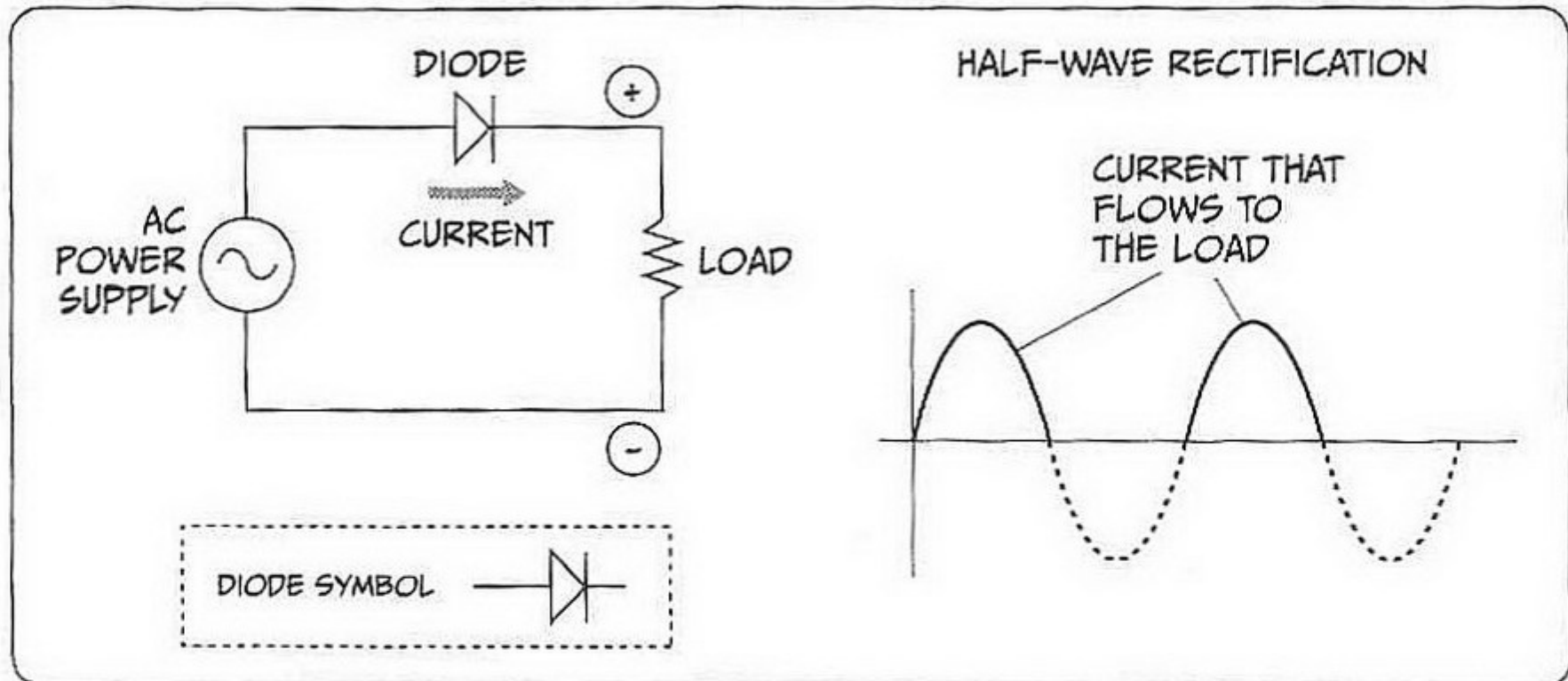

Half-wave rectification

When four diodes are arranged in a bridge configuration and an AC power supply is connected, the current of the entire cycle becomes positive and flows to the load. This kind of rectification is called *full-wave rectification*, and diodes that are connected in this way are called a *diode bridge*. Full-wave rectification enables current from the entire cycle of the AC power supply to be used as direct current.

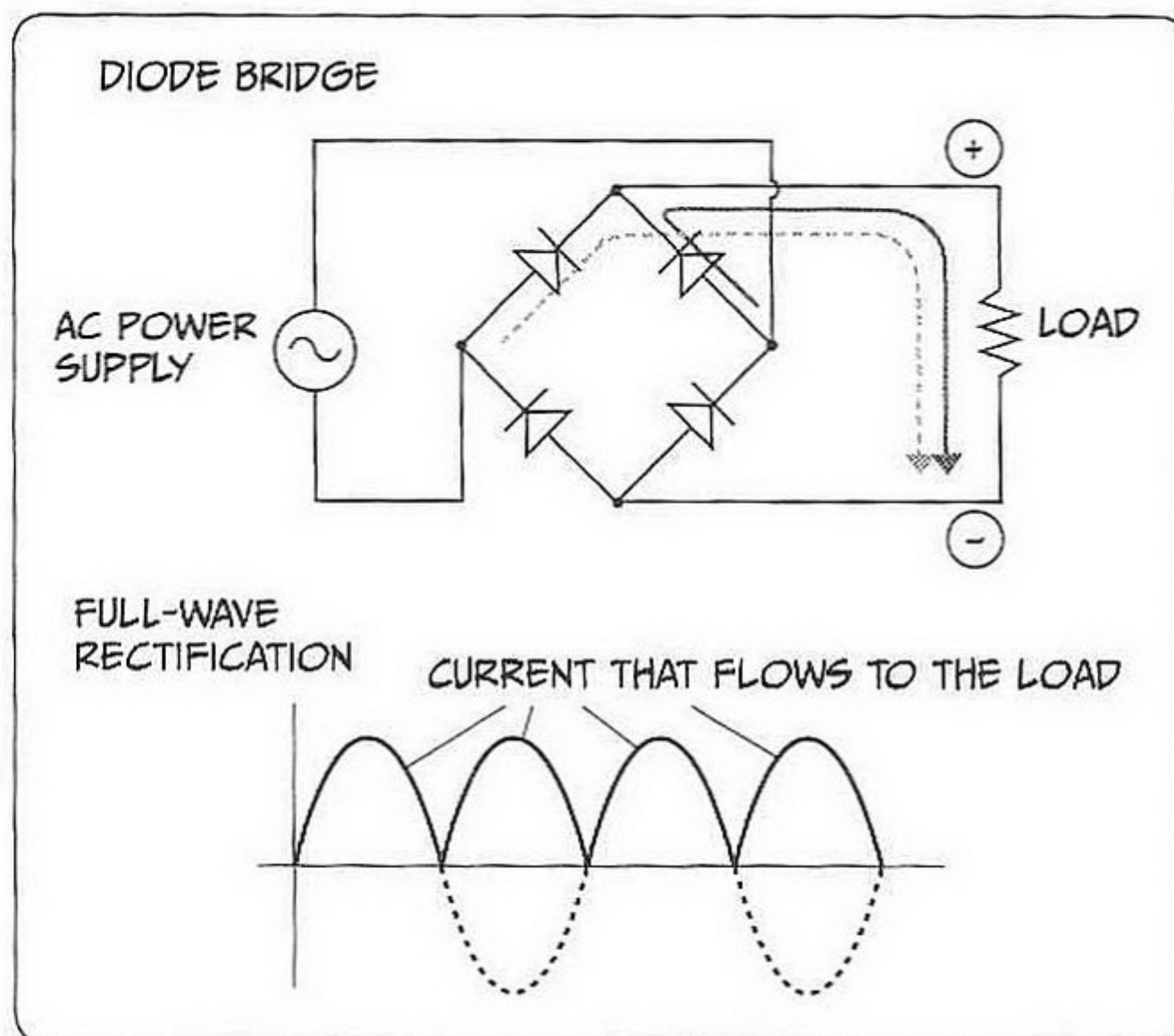

Full-wave rectification

Although this kind of full-wave rectification is more efficient than half-wave rectification, the waveform exhibits large pulsations. However, if an electrolytic capacitor is connected to the output, the charging and discharging of the capacitor can change the pulsations in the waveform into a flat, smooth direct current. A capacitor that is used to change a pulsating flow to a flat waveform in this way is called a *smoothing capacitor*.

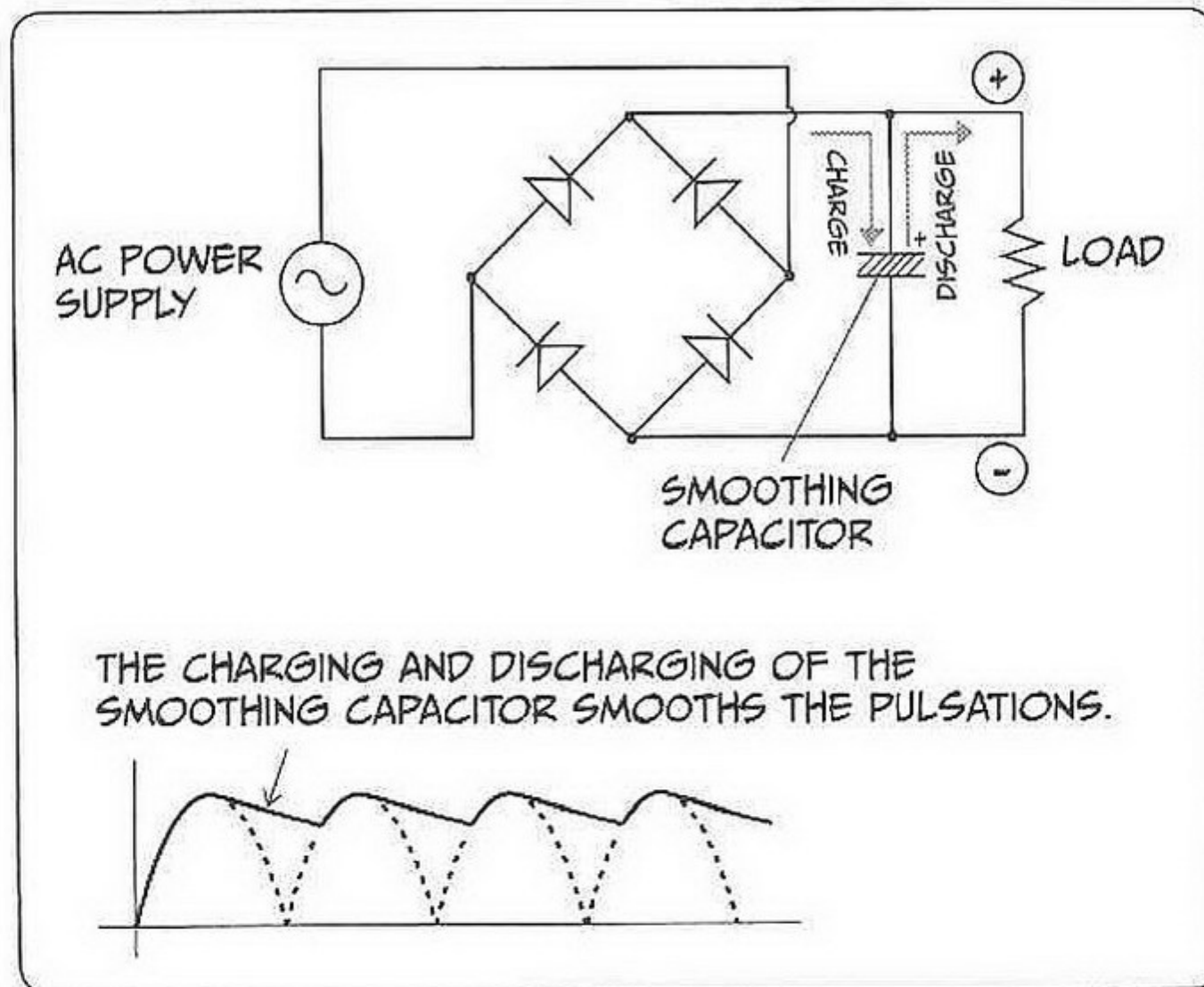

Smoothing capacitor

If a reverse-direction voltage is applied to a *Zener diode* (or *constant-voltage diode*) and the value of the voltage is steadily increased, current will flow once a certain voltage is reached. This phenomenon is called *breakdown*, and when the circuit voltage rises more than necessary, current can flow from the cathode to the anode to suppress the rise in voltage. This characteristic of a Zener diode is used in a constant voltage circuit that maintains a fixed voltage.

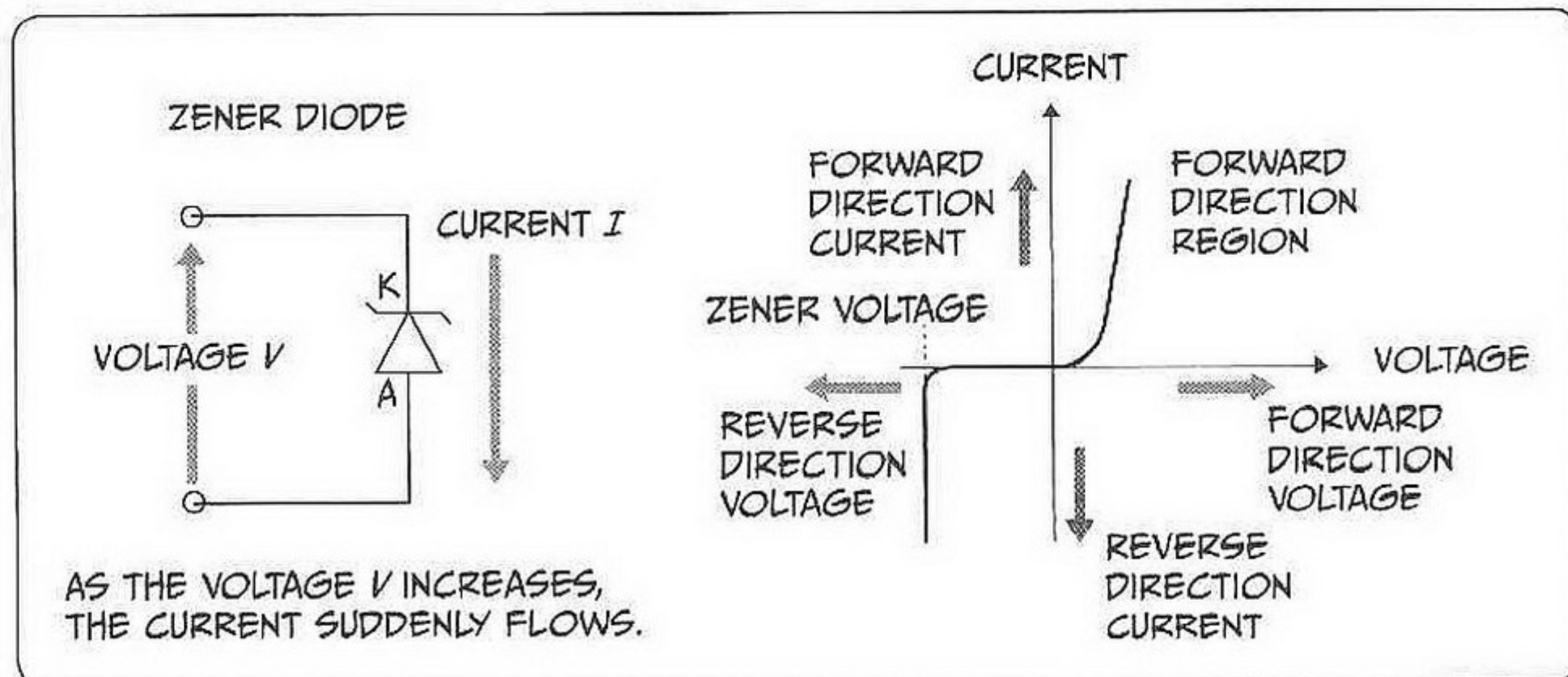

Characteristics of a Zener diode

If an ordinary diode is used as a Zener diode, it will be damaged because breakdown and the Zener current will be concentrated locally within the diode.

TRANSISTORS

A *transistor* is a semiconductor device that amplifies signals or acts as a switch by controlling the current or the voltage that is applied to an electrode.

When a large amount of electric power is controlled by a transistor that is used as a switch, the transistor is called a *power transistor*. Generally, an NPN-type transistor is used in this way.

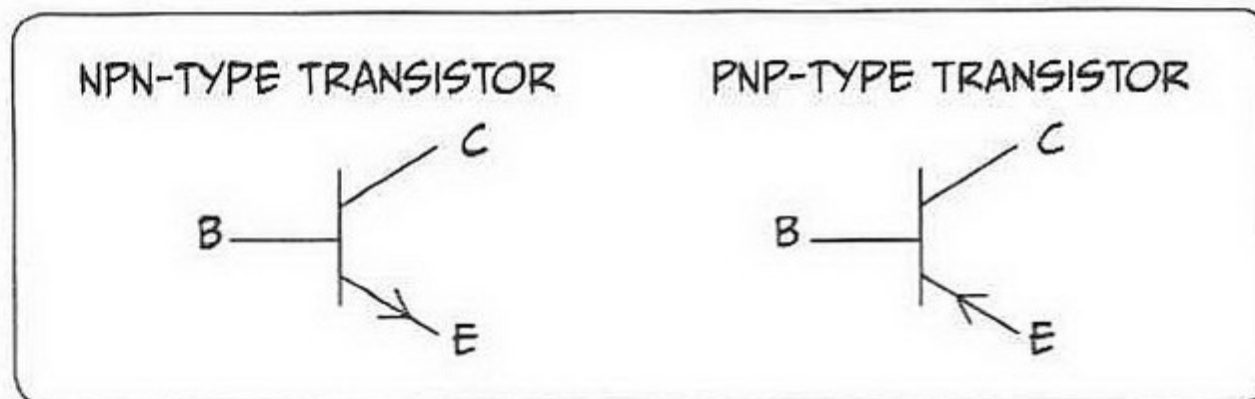

Transistor symbols

A switch that uses a transistor has no contact that will wear out, reducing the occurrence of failures, allowing it to be turned on and off rapidly, and allowing users to finely tune control of the device.

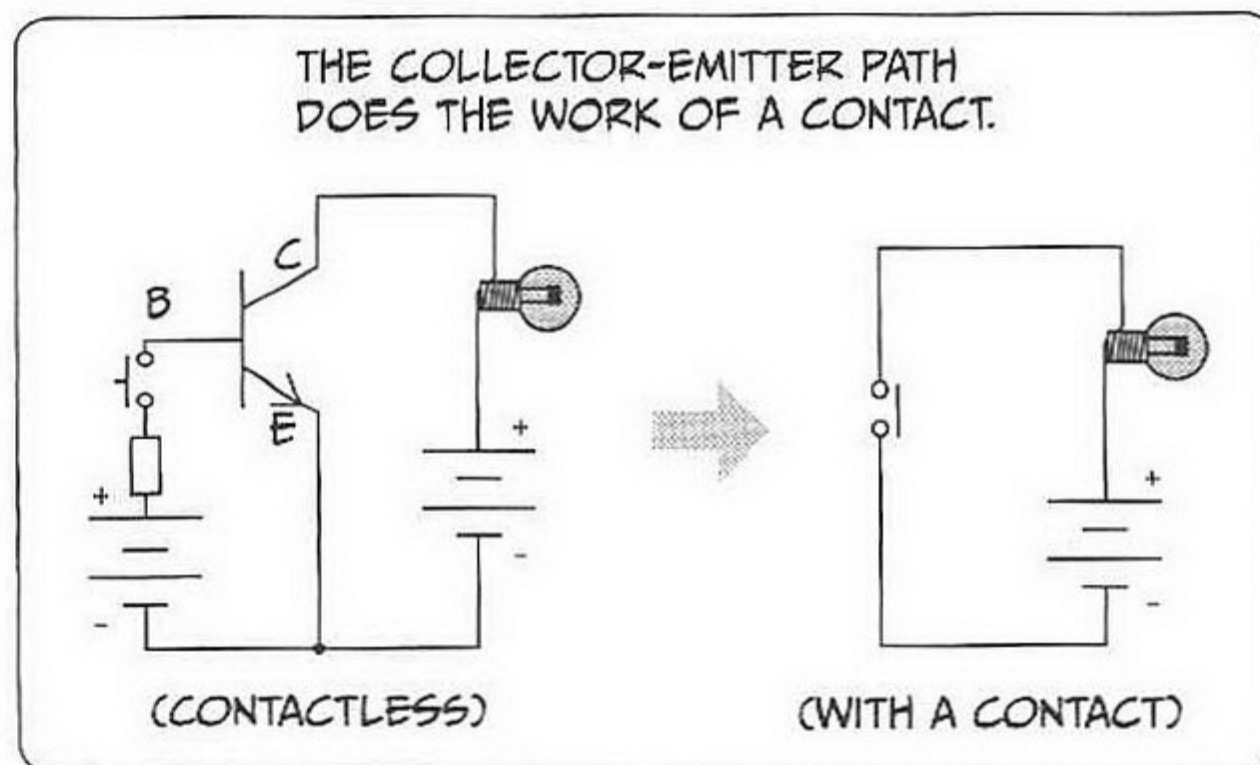

Transistor that does the work of a contact

FIELD-EFFECT TRANSISTOR

A transistor in which the collector current is controlled by the change of current that is input to the base is called a *bipolar transistor (junction transistor)*. In contrast, a transistor that is controlled by changing the voltage that is input, rather than the current, is called a *field-effect transistor (FET)*.

The merits of a field-effect transistor are that power consumption is low and response speed is extremely fast because current does not flow to the input. A field-effect transistor has three terminals that are referred to as *G* (*gate*), *D* (*drain*), and *S* (*source*), which correspond to the base, collector, and emitter of a bipolar transistor, respectively. A field-effect transistor controls the drain current according to changes in the voltage that is input to the gate.

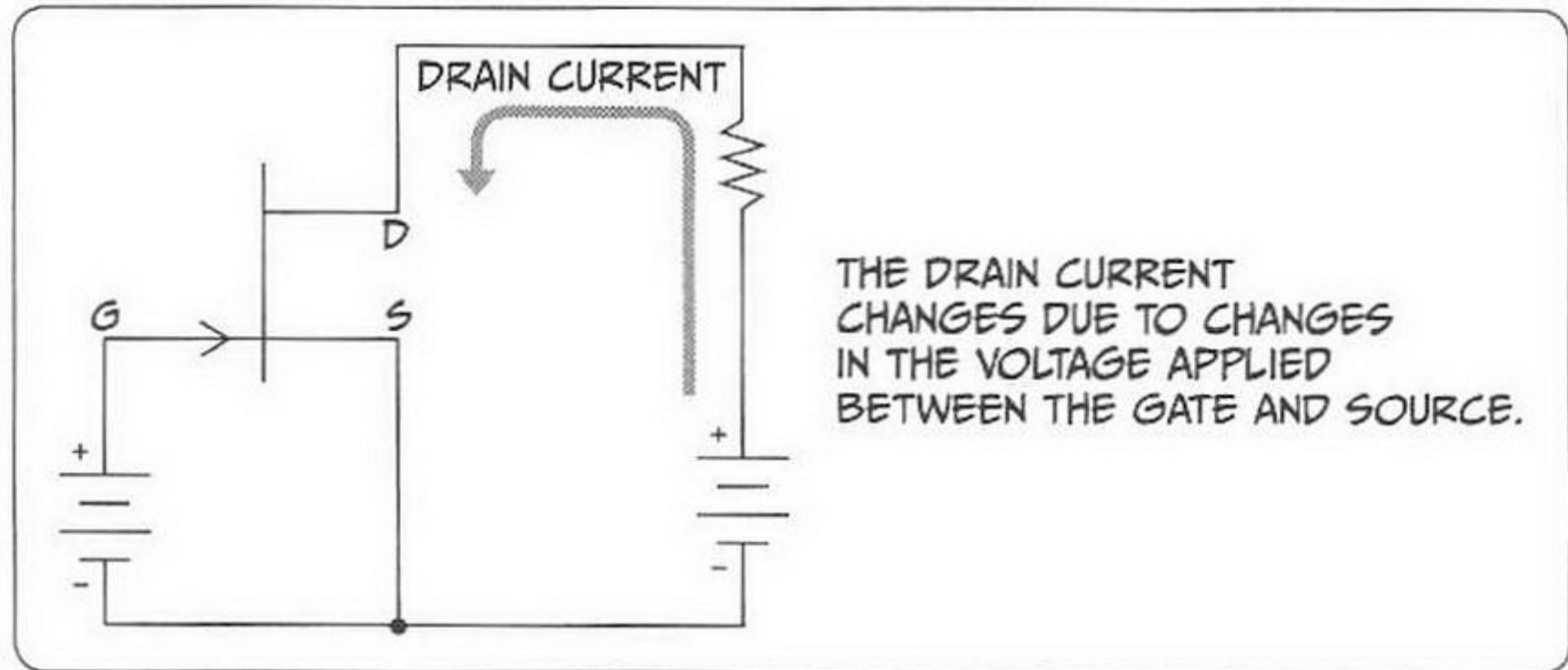

Field-effect transistor (N-channel type)

An *integrated circuit (IC)* is a device in which an extremely large number of elements such as transistors or resistors are placed on one component; ICs are used in more complex electronic devices such as TVs and computers. An amplifier called a *MOSFET (metal-oxide semiconductor field-effect transistor)*, in which the input gate is insulated by a thin film of silicon dioxide, is used in ICs.

CONVERTERS AND INVERTERS

A device that uses a diode to convert alternating current to direct current is called a *converter*, and a device that converts direct current to alternating current is called an *inverter*.

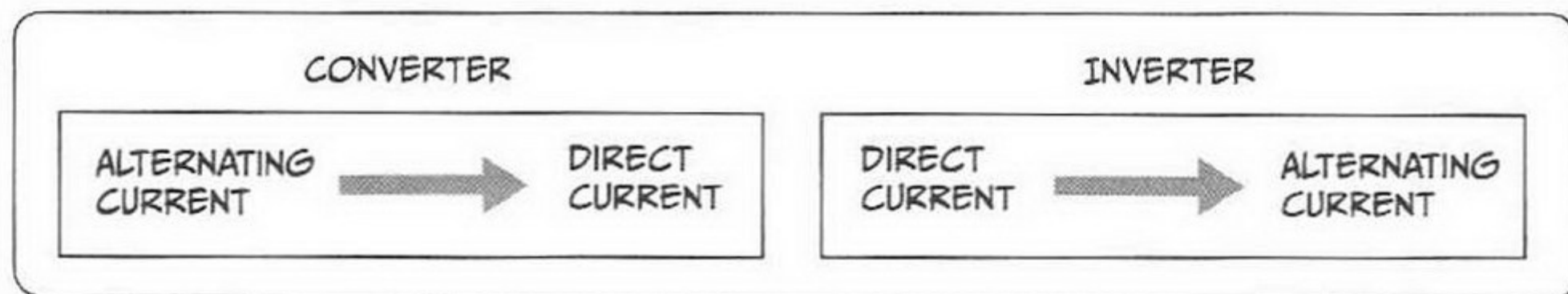

Converter and inverter

An inverter uses a semiconductor switching device such as a transistor to do the work of a switch. Single-phase alternating current can be produced by connecting four semiconductor switching devices and alternately turning on and off A, D, B, and C, as shown in the next figure. The frequency of the single-phase alternating current can be changed at will by varying the switching speed of the semiconductor switching devices.

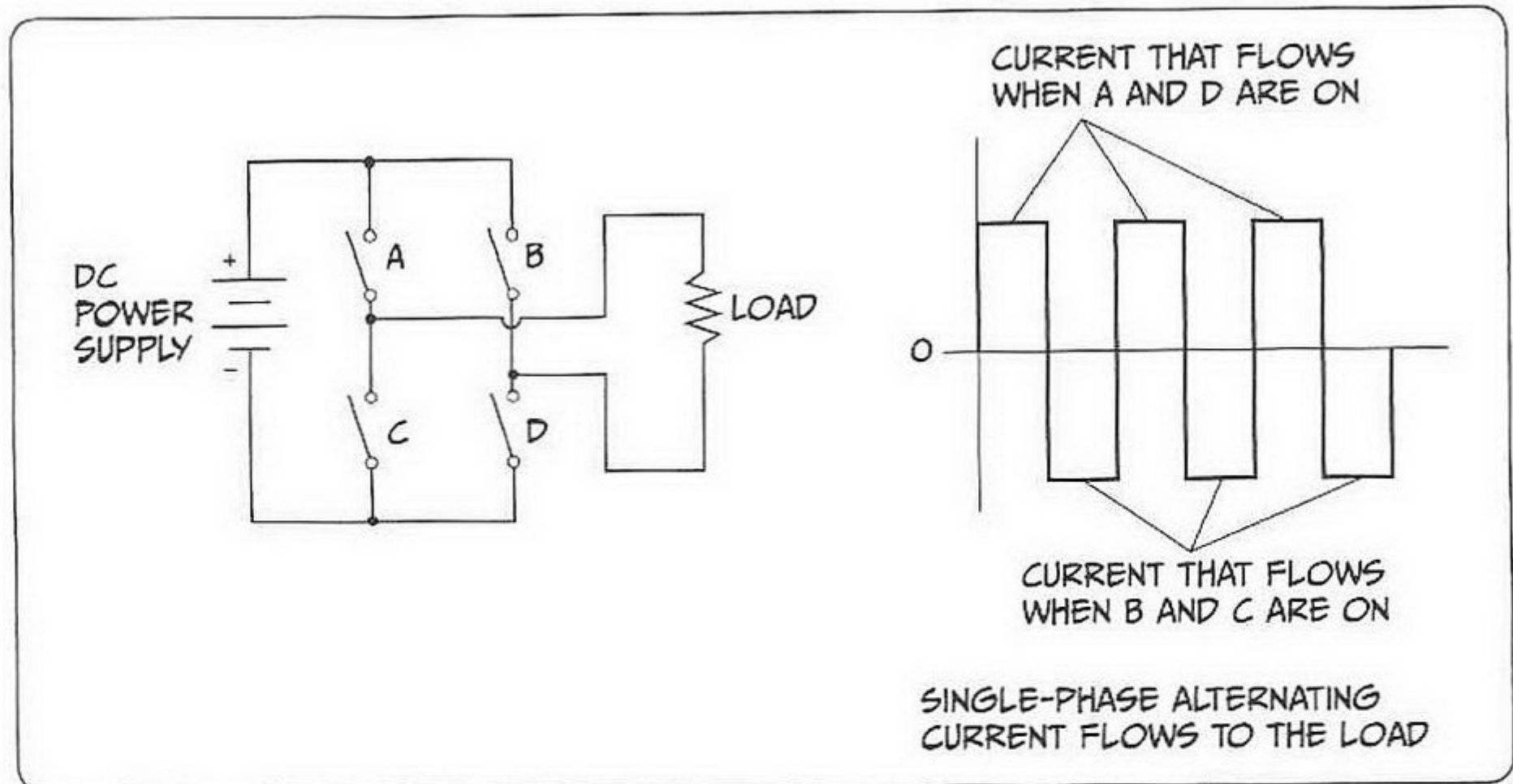

Single-phase alternating current created by an inverter

The rotational speed of an *induction motor* is directly proportional to the power supply frequency. If the supply frequency is constant, the rotational speed will also be constant.

For an air conditioner to cool the air, a motor must turn a compressor to compress the refrigerant gas. If the rotational speed of the motor is constant, a large capacity will be output even when a small capacity is required, and electrical power will be wasted.

Therefore, energy-saving operation with no waste can be achieved by using an inverter to create alternating current with the frequency required to continuously vary the rotational speed of the motor according to the required capacity.

A DC motor that is rotated by a DC power supply is used in the newest inverter air conditioners. In order to vary the rotational speed of the DC motor, the voltage must also vary, so a semiconductor switching device is used for this purpose.

In addition to air conditioners, inverters are also widely used in other familiar electrical appliances such as lighting or refrigerators and even in railroad cars.

SENSORS

Various sensors are used in electrical appliances in place of the perceptions of our eyes or skin. For example, an electric thermostat uses a temperature sensor to detect the temperature and turn a heater on and off, so we need not repeatedly turn the switch on and off ourselves.

Since sensors convert physical information such as light or heat to electrical information, if they are incorporated into an electric circuit, they can allow an electrical appliance to operate automatically. There are also sensors that can detect magnetism, which cannot be perceived by humans, or infrared rays, which cannot be seen by the naked eye.

TEMPERATURE SENSORS

A *temperature sensor* is a device that opens or closes a contact or varies electrical resistance according to the temperature it detects. Temperature sensors include contact-type sensors, which perceive the temperature by directly touching the substance whose

temperature they are trying to measure, and non-contact-type sensors, which perceive emitted thermal energy without directly touching the substance whose temperature they are trying to measure.

There are many types of contact-type temperature sensors such as thermostats, thermistors, and thermocouples. Non-contact-type temperature sensors include infrared sensors.

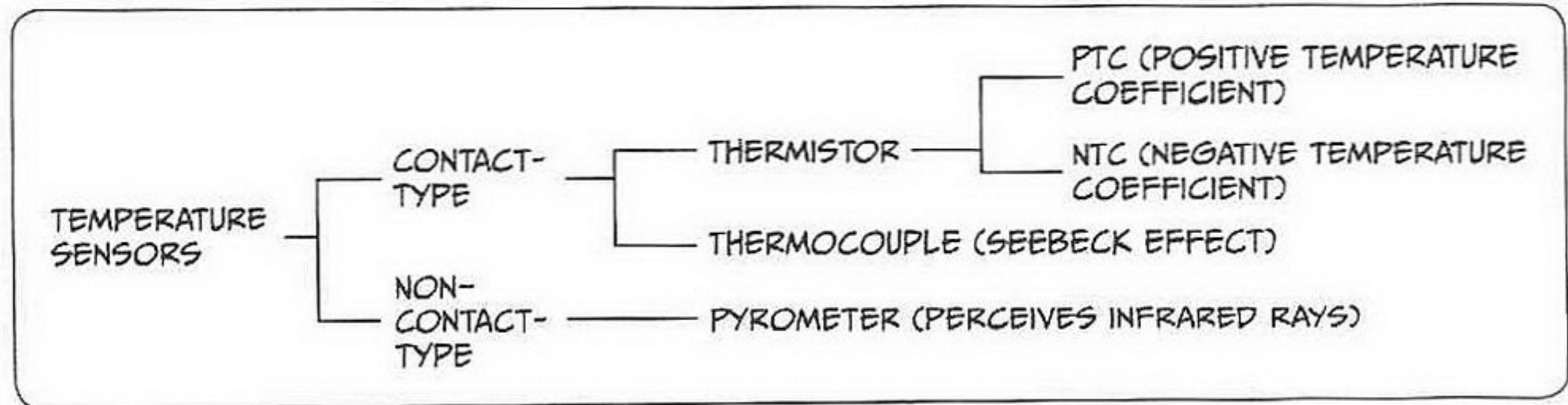

Classification of temperature sensors

A bi-metal thermostat is the simplest temperature sensor. It uses a bi-metal strip consisting of two types of metal with different thermal expansion rates, which curves in response to a temperature change. Although a thermostat is used in an appliance like an electric blanket, since the heater is turned on and off directly by a contact, the thermostat can only control large temperature fluctuations. A temperature sensor using a bi-metal strip is also used for the overcurrent action of a circuit breaker.

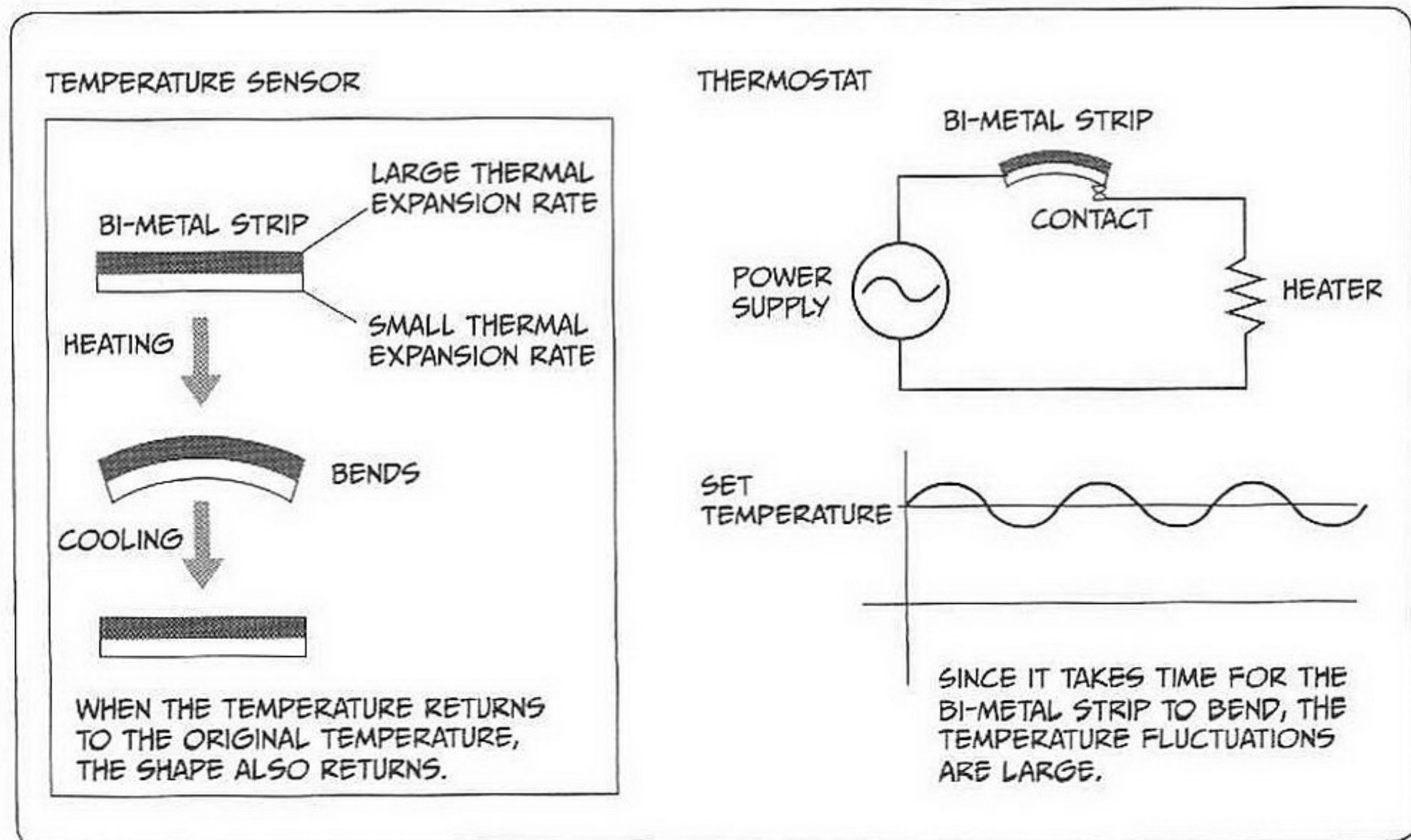

Temperature control by a bi-metal thermostat

A *thermistor* is a temperature sensor whose electrical resistance varies according to a temperature change. Generally speaking, electrical resistance also varies with temperature

for any metal. However, thermistors' resistance changes significantly, even in response to a small temperature change. Since a large current does not flow directly to a thermistor, it is used in combination with an electrical circuit to control temperature.

Thermistors are classified into *positive temperature coefficient (PTC) thermistors*, those whose resistance value rises when the temperature rises, and *negative temperature coefficient (NTC) thermistors*, those whose resistance value falls when the temperature rises.

The newest air conditioners and electric refrigerators use thermistors for temperature sensors, combined with electrical circuits that use semiconductor devices to enable temperature control to be finely tuned.

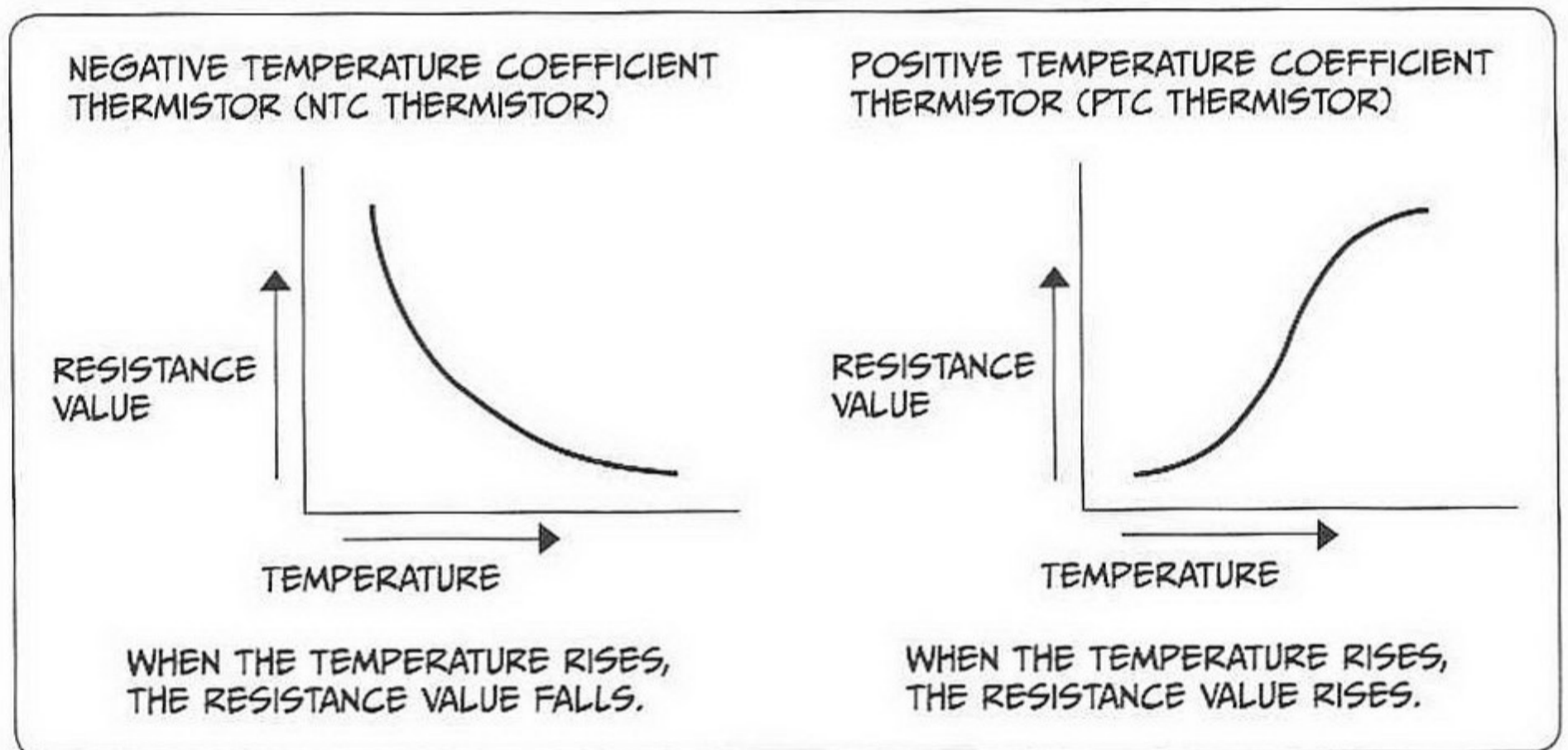

Temperature characteristics of thermistors

OPTICAL SENSORS

An *optical sensor* perceives light like our eyes do. These sensors are frequently used to automatically turn on street lights when it gets dark, and they function as the receiver of an infrared remote controller on an electrical appliance.

An optical sensor converts light energy to electrical signals. The phenomenon in which a substance such as a metal absorbs light energy and emits electrons as a result is called the *photoelectric effect*.

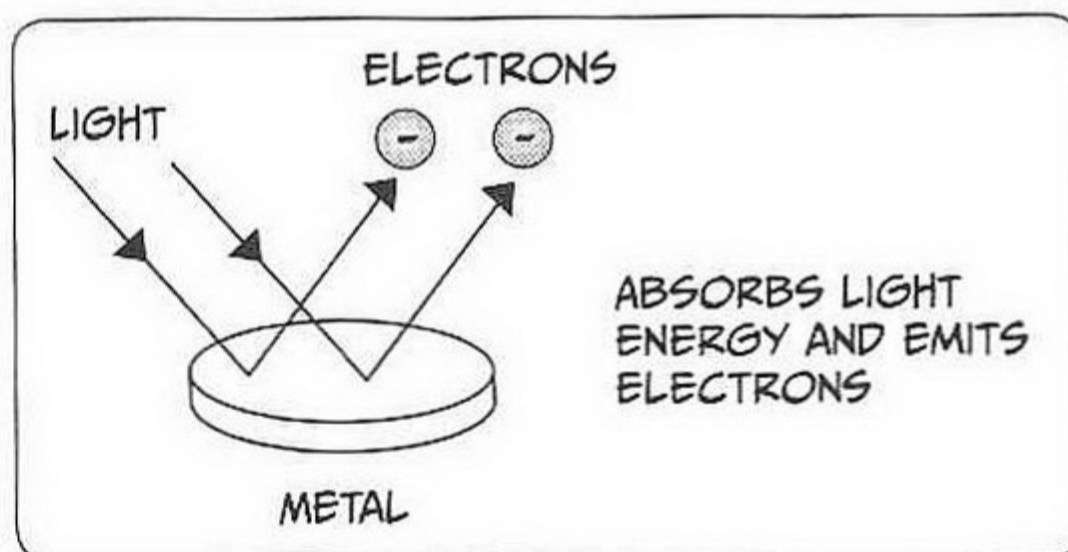

Photoelectric effect

The phenomenon that describes how voltage appears at the junction of a semiconductor due to the photoelectric effect is called the *photovoltaic effect*. Optical sensors that use the photovoltaic effect include *photodiodes* and *phototransistors*. A solar cell that is used for photovoltaic power generation also uses the photovoltaic effect to create electricity.

A *solar cell* generates an electromotive force when light energy strikes the p-n junction surface, causing the electrons and holes to move to the negative and positive poles, respectively. When a load is connected to a solar cell, current flows.

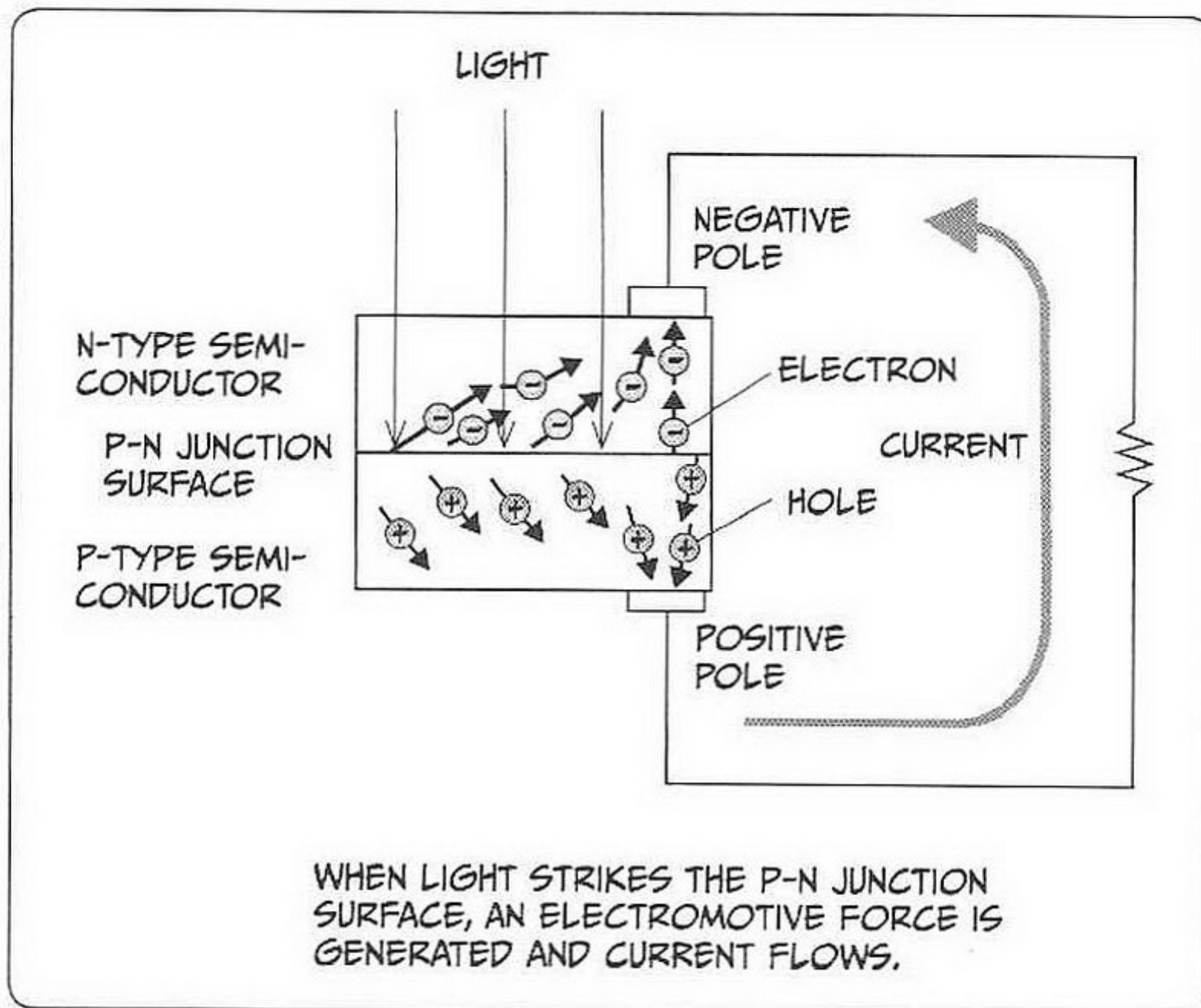

Photovoltaic effect of a solar cell

The effect in which a carrier of electricity such as an electron is generated by the photoelectric effect, thus causing the internal resistance value of a substance to change, is called *photoconductivity*. A *cadmium sulphide (CdS) cell* is a solar cell that functions using photoconductivity.

A *photodiode* is a semiconductor device in which current flows from the cathode to the anode due to the photovoltaic effect when light or infrared rays are received. The current that flows at this time varies according to the intensity of the light, and the photodiode measures this current.

The current when the light is received is extremely small. It is generally used by applying a reverse-bias voltage.

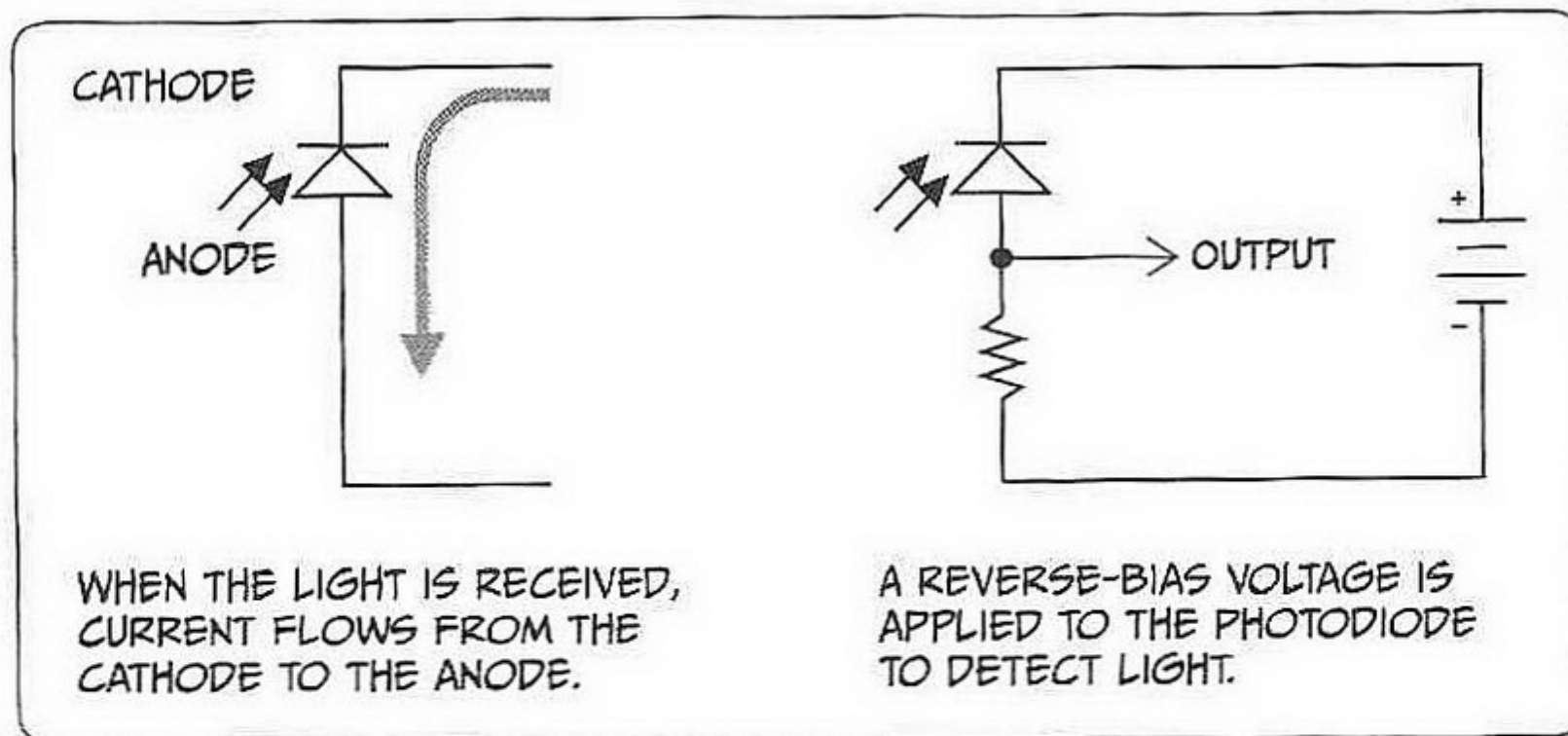

Photodiode

A photodiode combined with a transistor is called a *phototransistor*. Although a phototransistor has no base, a collector current flows when light is received in a manner similar to how base current flows in a transistor. The current in the collector varies according to the intensity of the light.

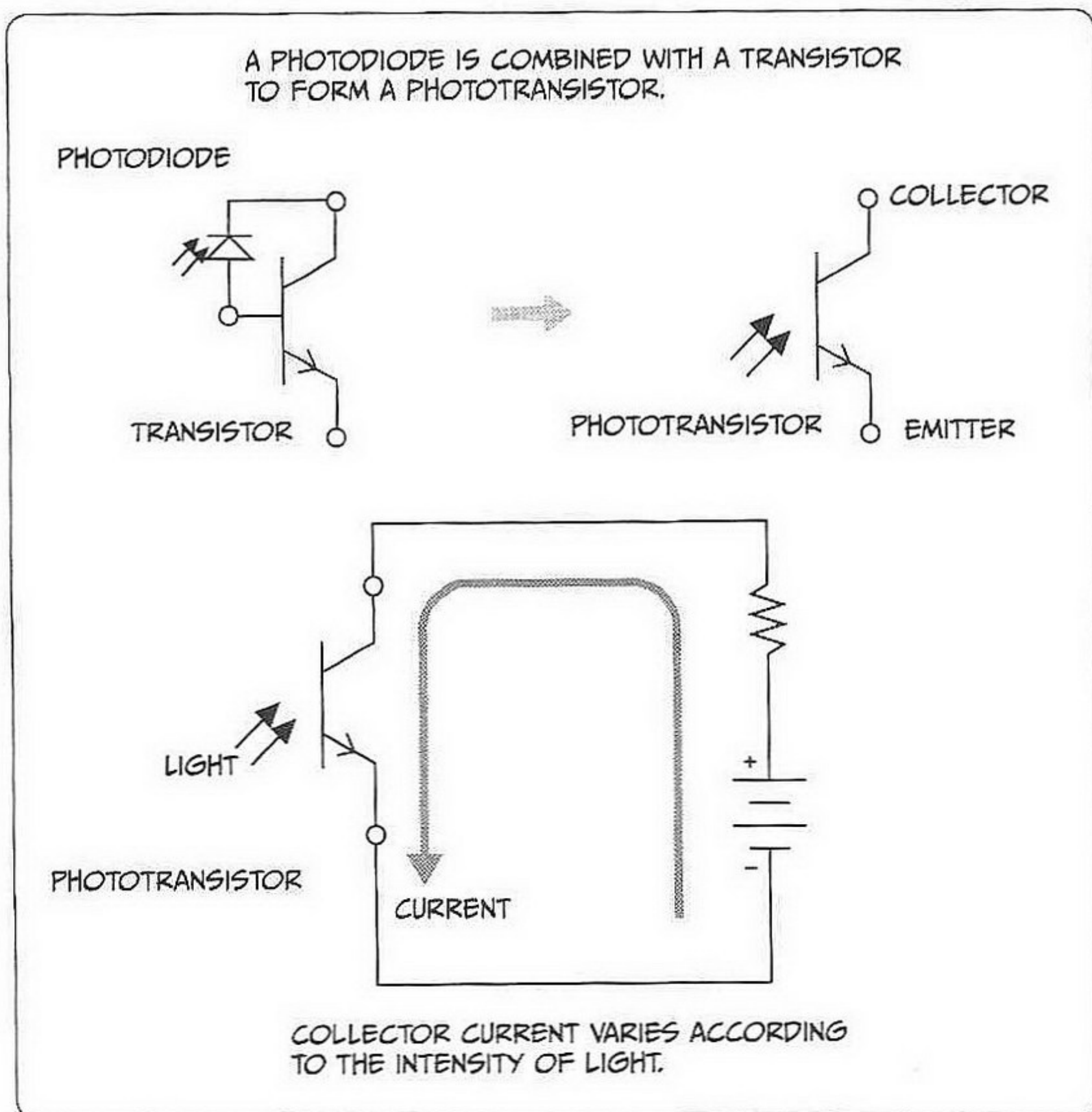

Phototransistor

An optical sensor like a phototransistor can be used to determine the position or existence of a target object without touching it.

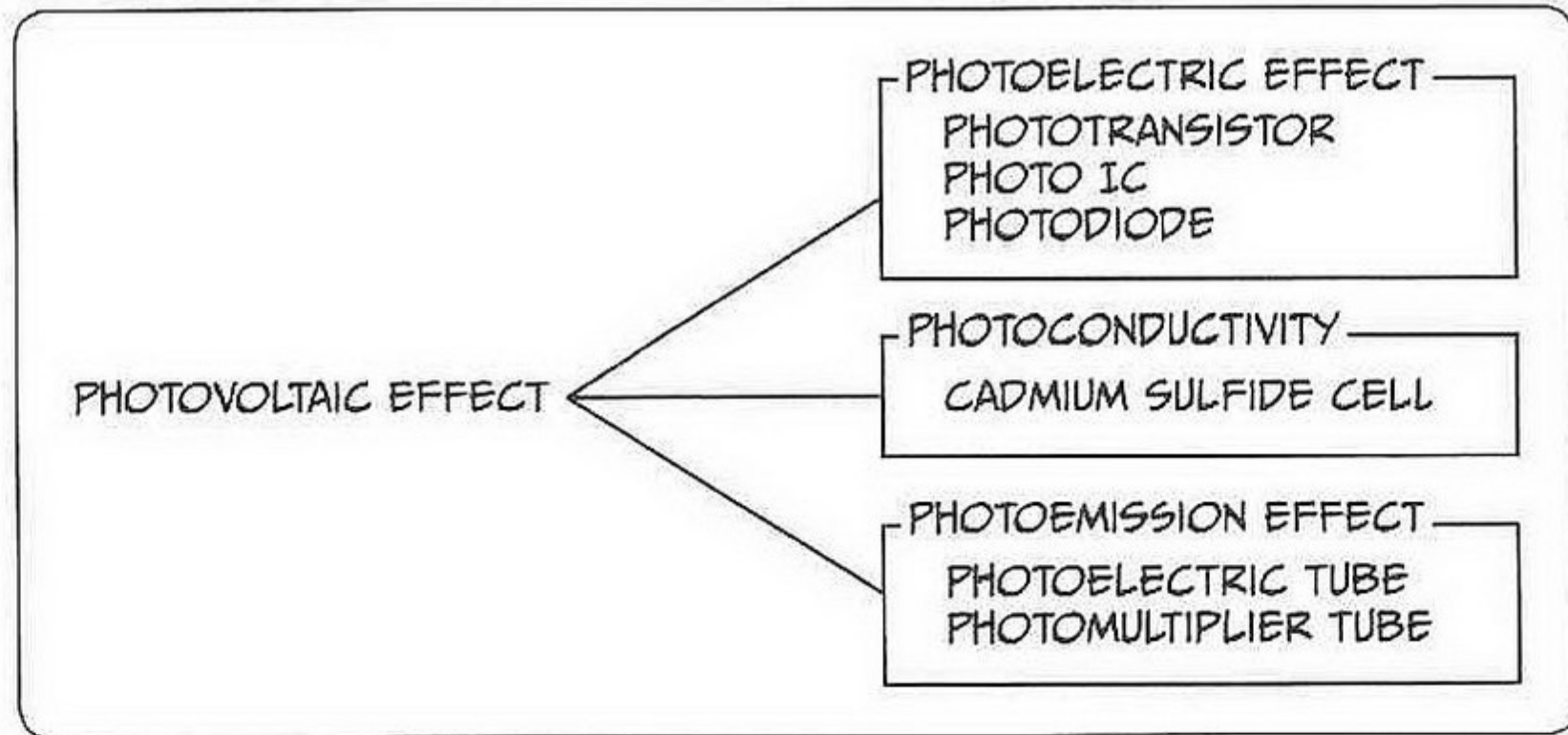

Photoelectric effect and optical sensors

Optical sensors are widely used for various purposes such as detecting brightness and turning on or dimming lights; an optical sensor can also be used in a security system as a photoelectric eye that detects the changes in light—that is, movement.

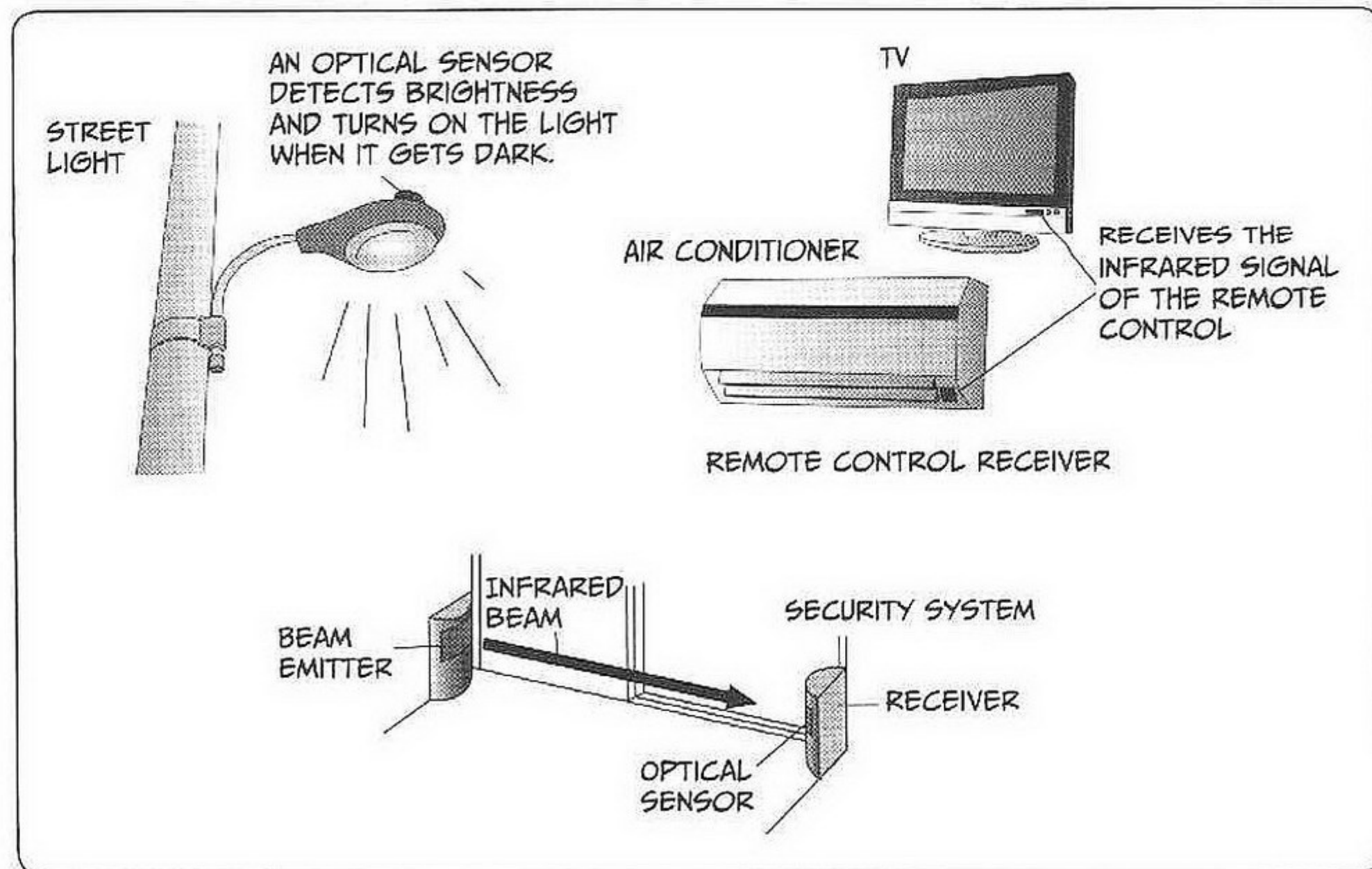

Uses of optical sensor

WITHOUT REREKO AROUND,
I RETURNED TO REGULAR
LIFE—SPENDING ALL MY
TIME IN THE LAB.

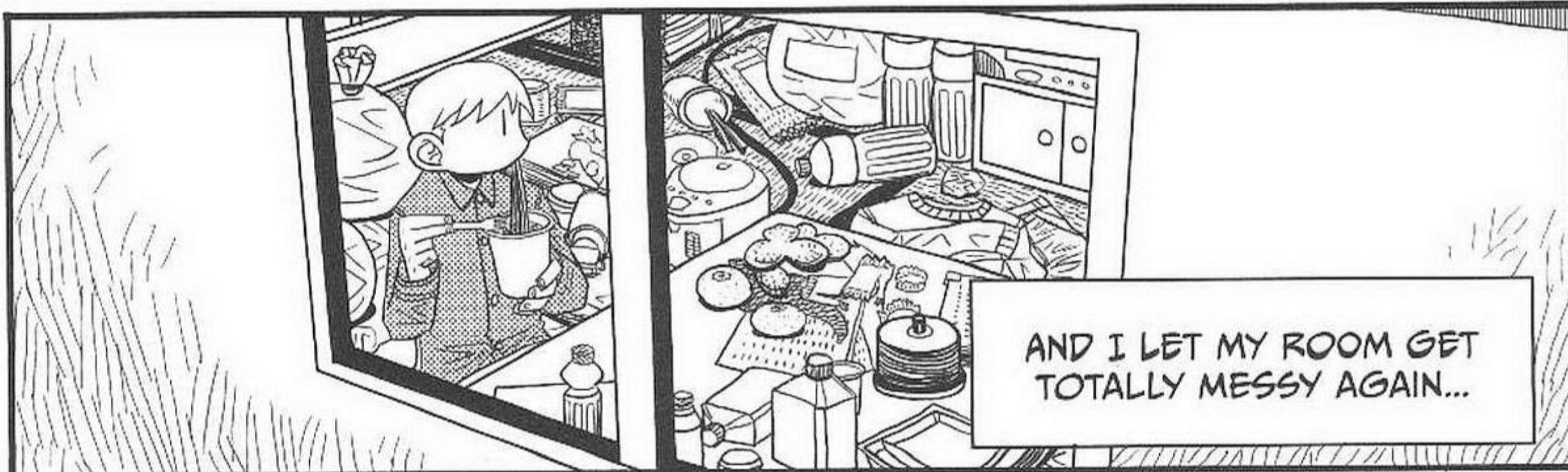

AND I LET MY ROOM GET
TOTALLY MESSY AGAIN...

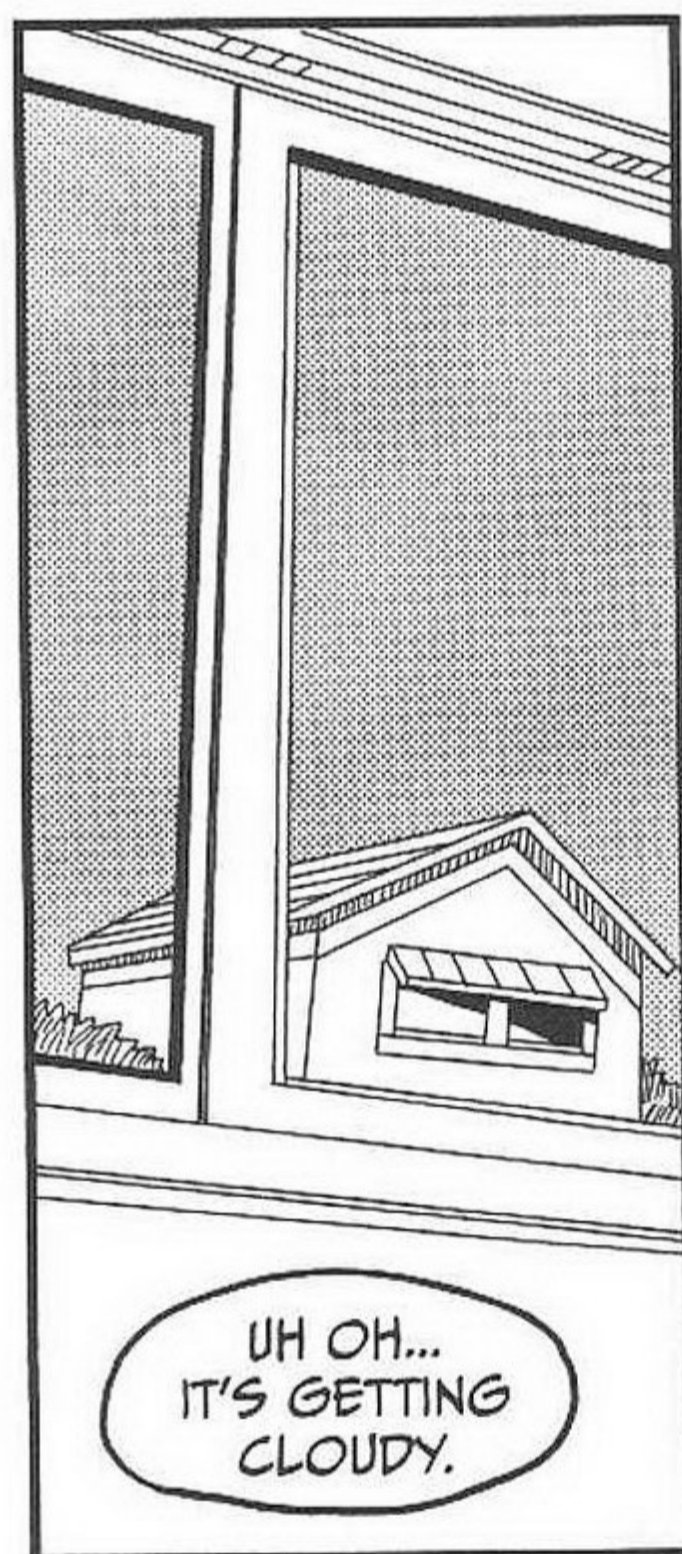

UH OH...
IT'S GETTING
CLOUDY.



IT'S BEEN A
WHOLE YEAR...
I REMEMBER THE
WEATHER THAT
DAY WAS LIKE IT
IS NOW.

I GUESS I'LL
TRY TO BEAT
THE RAIN!

UMPH.

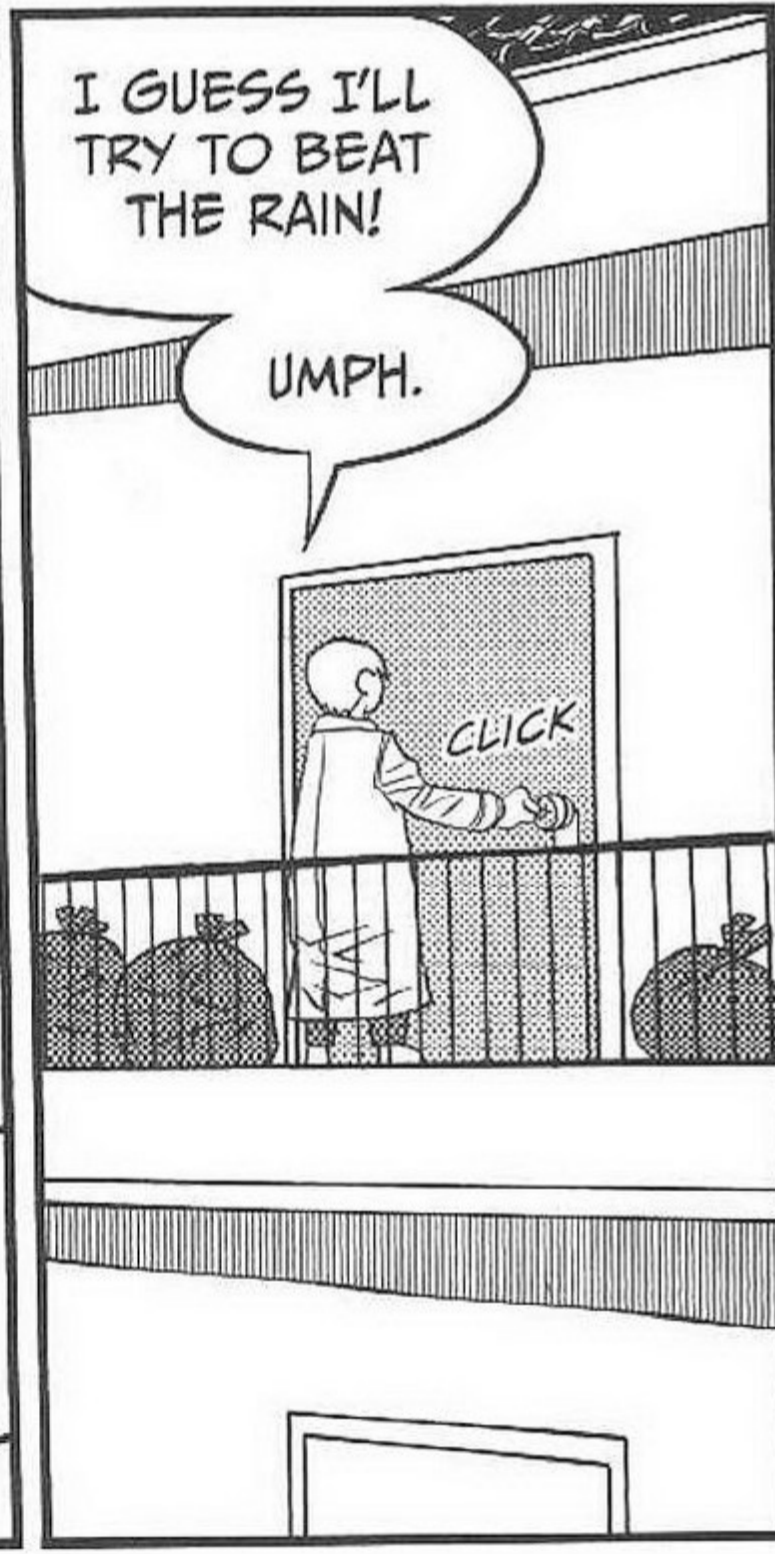

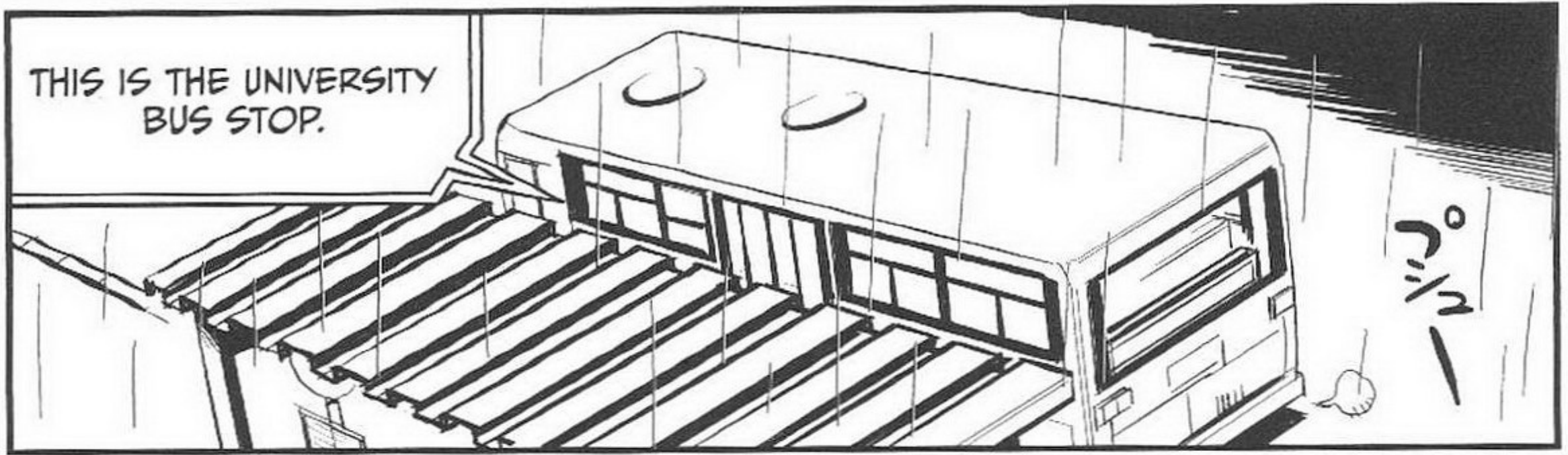

THIS IS THE UNIVERSITY
BUS STOP.



JEEZ!! WHAT
A SUDDEN
DOWNPOUR...



I'M GOING TO
GET SOAKED!
I WISH I'D
BROUGHT AN
UMBRELLA...

??



I REMEMBER
SAYING THAT ON
THAT DAY A YEAR
AGO, TOO...



WHAT
THE...????

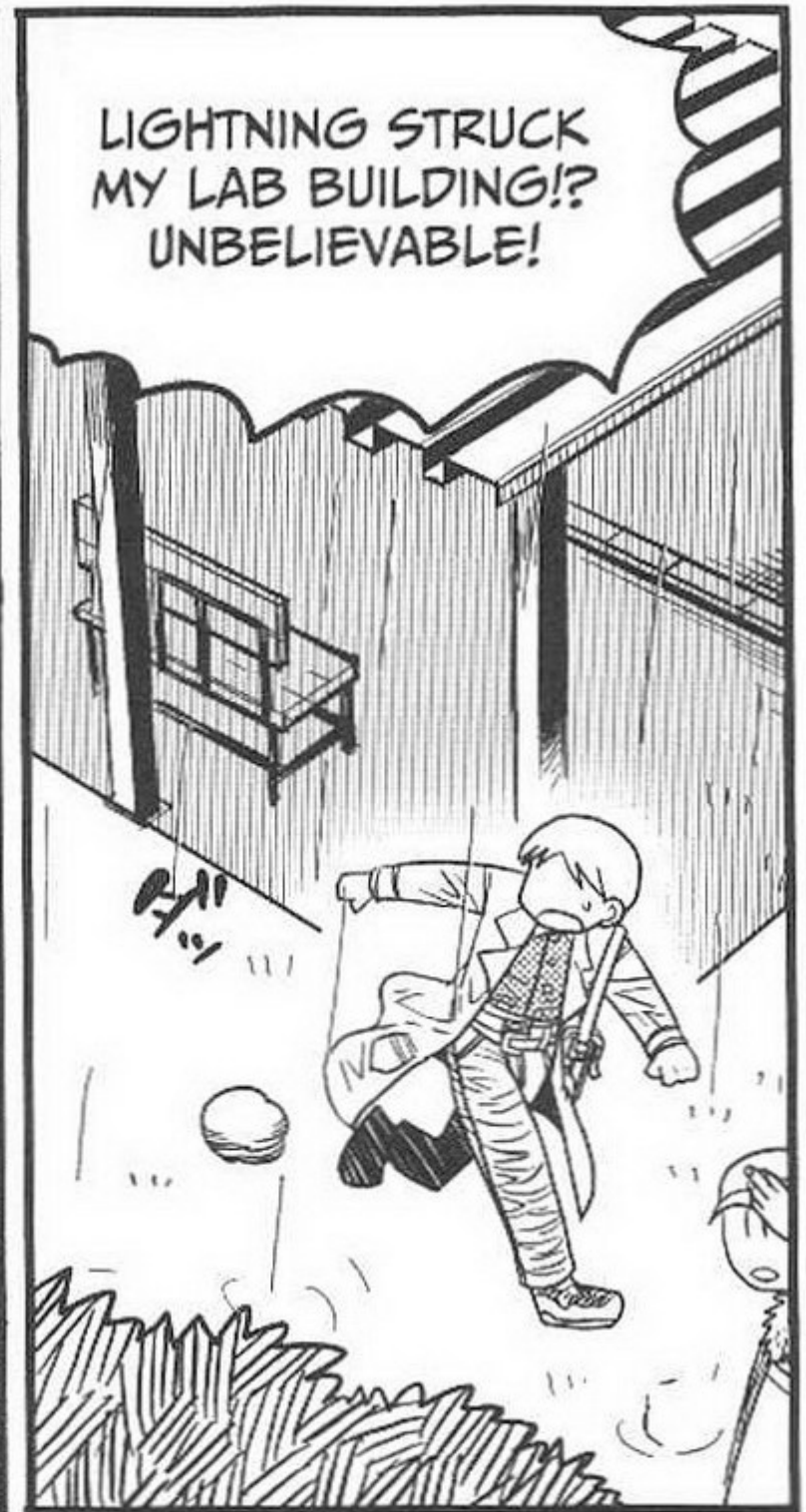

LIGHTNING STRUCK
MY LAB BUILDING!?
UNBELIEVABLE!

LABORATORY

SWOOSH!

I WONDER IF MY DATA IS OKAY...!?

HIKARU SENSEI!?

AHHHH!

ZZZUUUH?

RE...REREKO!?

YEP, IT'S ME!!
IT'S NICE TO SEE
YOU AGAIN!

WHY ARE YOU BACK?
MORE MAKEUP
CLASSES!?

NOPE!
THANKS TO YOU,
I HAD NO PROBLEM
GRADUATING.



INDEX

- A**
absolute zero, 87, 88, 104-105
AC. See alternating current (AC)
active material, 132
air conditioners, 192
alkaline dry cell batteries, 125, 133-134
alternating current (AC), 64-66, 75-76, 113-116, 121, 123, 149, 173, 189-190
circuits, 75-76
power supply, 114, 121, 123, 186
amber, 25
ammeter, 143
Ampère, André Marie, 45
amperes/amps (A), 16, 45, 68
Ampère's law, 96, 107-108
anemometer/anemoscope, 154
anions, 127
anodes, 136-139, 169, 171, 193
appliances, electrical, 19, 24, 45, 46, 56-58, 71-72, 96, 123, 190
atomic numbers, 34
atomic structures, 34-35
atoms, 26-28, 34-35, 47, 127, 165
attraction, force of, 25, 49-50, 97, 108
- B**
base-collector junction, 179
base current, 178, 179-181, 182
base-emitter junction, 177-178
batteries, 45, 59-60
AA, 46-47, 74
chemical reactions and, 120
coils and, 112
coin, 140-141, 174
creating your own, 140-141
dry cell, 125, 130, 131, 132-134, 171-172, 178
in flashlights, 59, 73
lithium, 125
as power supplies, 63-64, 124-125
solar, 125
supply voltage, 46-47
types of, 125
voltage of stacked, 47
bi-metal thermostats, 191
bipolar transistors, 188
boilers, 147
boiling water reactors, 151-152
boron, 167, 168
breakdowns, 187
breakers, 19, 21-23
circuit, 19, 21
- C**
cadmium sulphide (CdS) cells, 193
calories, 85, 86, 104
capacitance, 115
capacitive reactance, 116
capacitors, 115-116, 187
cathodes, 136-139, 169, 171, 193
cations, 127, 128
CdS (cadmium sulphide cells), 193
cells, 124-132
cadmium sulphide, 193
chemical, 124-132
fuel, 124-125, 135-138
galvanic, 126, 130
physical, 124-125
solar, 125, 193
voltaic, 125
water, 135-137
charges, 29
attraction and repulsion, 25, 49-50, 97, 108
electrical discharges, 31-33, 51
measuring, 49
negative/positive, 29, 30-33, 36-39, 42, 47-48, 50-52
polarity of, 41
stored on capacitors, 115
chemical cells/reactions, 124-132, 137, 138
circuits
alternating current, 75-76
in appliances, 56-58
breakers, 19, 21
closed, 61, 73
connection methods used in, 69-72, 78-80
creating your own, 141, 142
diodes in, 171
direct current, 64, 74-75
drawings of, 73, 74
electrical parts of, 61-66, 73
in flashlights, 58-61, 73
integrated (ICs), 183
parallel, 79
closed current, 61
coal (as fuel), 147, 149
coils, 108, 111-115
coin batteries, 140-141, 174
collector current, 179-181
collector-emitter current, 182, 183
collectors, 177-180, 182
combined cycle generation, 149, 150-151
compasses, 95
compound semiconductors, 163
condensers, 149, 151
conductance (G), 77
conductivity, 34-35, 77, 135, 166, 168
photoconductivity, 193, 195
superconductivity, 88, 105
conductors, 30-31, 98-100, 108-110, 127, 148, 161, 162
connections, electrical, 69-72, 78-80
constant-voltage diodes, 187
consumed power, 17-18
consumer electric products, 20-24. See also electrical appliances

contactless switches, 181-182
 contacts, switch, 60, 61, 73, 188
 contact-type sensors, 191
 control rods, 151
 converters, 189-190
 copper
 atoms, 35
 plate, 126, 127, 128, 130, 140
 wires, 31, 104, 128
 copy machines, 43
 cotton, 41-42, 51
 Coulomb, Charles Augustine, 49
 Coulomb's force, 29, 43, 49-50
 coulombs (Q), 45, 49-50, 104
 counter-electromotive force, 112
 current (*I*)
 alternating, 64-66, 75-76,
 113-116, 121, 123, 149,
 173, 189-190
 base, 178, 179-181, 182
 closed, 61
 collector, 179-181
 collector-emitter, 182, 188
 defined, 16, 45, 51, 128
 direct, 64, 66, 74-75, 123,
 149, 173, 189-190
 direction of, 33, 51-52, 63-66,
 75, 96-97, 98-101
 drain, 189
 fixed, 63, 74
 flow of, 15-17, 20-24, 58,
 61, 63-68, 73-78, 96,
 108-109, 128
 forward direction, 187
 induced, 111
 lagging, 113
 leading, 116
 limiters, 21
 measuring, 16, 143
 rated, 23
 size of, 52
 speed of, 53
 temperature differences,
 142-143
 water, 181

D

dam-type power generation,
 152-153
 DC. See direct current (DC)
 depolarizers, 131
 digital cameras, 175
 diodes, 163, 169-171, 173, 177,
 183, 186-188, 189
 bridges, 186
 constant-voltage, 187
 light-emitting, 141, 174-175
 photodiodes, 193-194
 Zener, 187-188
 direct current (DC), 64, 66, 74-75,
 123, 149, 173, 189-190
 circuits, 64, 74-75
 power supply, 74
 direction, current, 33, 51-52,
 63-66, 75, 96-97, 98-101
 discharges, electrical, 31-33, 51
 doping, 164
 drain, 189
 current, 189
 dry cell batteries, 125, 130, 131,
 132-134, 171-172, 178

E

effective resistance, 69-72, 78-80
 effective voltage, 75-76, 123, 149
 electric
 current. See current
 generators, 101, 110,
 120-123, 147-149,
 152-154
 heaters, 62, 74
 outlets, 23-24, 63-64,
 123, 149
 power, 17-18, 19, 45, 46
 resistance. See resistance (*R*)
 shocks, 40, 66
 wires, 74, 77, 88, 96, 107,
 108, 148. See also coils
 electrical
 appliances, 19, 24, 45, 46,
 56-58, 71-72, 96, 123, 190

 charges. See charges
 connections, 69-72, 78-80
 discharges, 31-33, 51
 potential, 46-47
 electricity, nature of, 25-29
 electrochemical reactions, 132
 electrodes, 127, 136, 169, 177
 electrolytes, 126, 130, 132, 140
 electromagnetic
 force, 109, 111
 induction, 111-112
 waves, 91, 106-107
 electromotive force, 61, 73,
 100, 110, 111, 112,
 122, 130
 electrons, 26-29, 34-35, 47-48
 in chemical reactions, 128-129,
 137, 138
 collisions of, 89-90, 93, 105
 free, 27-28, 35, 47-48, 166,
 167, 170, 171
 holes, 167, 170, 174, 177-178
 movement and electric charges,
 49, 51-53
 single, 48
 speed of, 53
 valence, 34-35, 48,
 165-166, 167
 electron shells, 34-35, 47-48, 165
 electrostatic force, 29, 43, 49-50
 electrostatic induction, 40, 50
 emitter, 177-180, 182
 energy
 defined, 46
 heat, 61, 62
 light, 61, 62
 measuring, 46
 solar, 124-125
 thermal, 106, 124
 environmentally friendly
 power, 154
 escaped electrons. See free
 electrons
 Europe, voltage in, 45
 extrinsic semiconductors, 164, 168

F

farads, 115
field-effect transistor (FET), 188-189
fixed current, 63, 74
flashlights, 58-61, 73
Fleming, John Ambrose, 109
Fleming's left-hand rule, 98-99, 109
Fleming's right-hand rule, 100-101, 110, 121, 148
flow, current, 15-17, 20-24, 58, 61, 67-68, 73-78, 96, 108-109, 128
fluorescent lights, 92-93, 106-107
force of attraction, 25, 49-50, 97, 108
force of repulsion, 49-50, 97
forward bias voltage, 173, 174
forward direction current, 187
Francis turbine, 153
free electrons, 27-28, 35, 47-48, 166, 167, 170, 171
frequency, 65, 75, 122
frictional electricity, 38, 49. *See also* static electricity
fuel (oil, coal, and gas), 147, 149, 150
fuel cells, 124-125, 135-138
fuel reformers, 139
full-wave rectification, 186-187
fuses, 19

G

gallium arsenide, 163
galvanic cells, 126, 130
gamma rays, 91
gas (as fuel), 147, 149, 150
gas turbine generation, 149, 150
gate, 189
generators, 101, 110, 120-123, 147-149, 152-154
geomagnetism, 95
germanium, 163-164
giga-, 46
glass, 41-42, 51
graphical symbols, 73-74

H

hair, 41-42, 51
half-wave rectification, 186-187
heat energy, 61, 62
heaters, electric, 62, 74
heat generation, 85-93, 104-105, 123, 143-144
heat rays. *See* infrared rays
hertz (Hz), 65, 75, 122, 149
high potential electricity flow, 16, 46-47
high-temperature resistance, 89
high-temperature superconductors, 105
holes, 167, 170, 174, 177-178
home distribution boards, 20-21
hydroelectric generator, 110, 152-154
power generation, 120, 147
hydrogen gas, 129, 130, 131
ions, 129, 137, 138, 139
Hz (hertz), 65, 75, 122, 149

I

ICs (integrated circuits), 183
impedance, 116
induced current, 111
induced electromotive force, 111, 114
inductance, 112
induction
electromagnetic, 111-112
electrostatic, 40, 50
motors, 190
mutual, 114
inductive reactance, 113
infrared rays, 90-91, 106
innermost shells, 47
instantaneous voltage, 75-76
insulators, 30, 32, 161, 162
integrated circuits (ICs), 183
intensity of electricity, 45
internal combustion generation, 149, 150
International System of Units (SI units), 46

intrinsic semiconductors, 164
inverse ohms, 77
inverters, 189-190
ionization, 129
ions, 127, 129

J

Japan, 45, 65, 153, 154
Joule, James Prescott, 104
joule heat, 86, 104
joules (J), 45, 46, 104
junction transistors, 188

K

Kaplan turbine, 154
kilo-, 46
kilowatt hours (kWh), 18-19, 46

L

lagging current, 113
leading current, 116
LED (light-emitting diode), 141, 174-175
Lenz, Heinrich Freidrich Emil, 111
Lenz's law, 111
light bulbs, 59, 60-62, 71-72, 73
light emission, 92-93, 106-107
series connection of, 79, 80
light emission, 91-93, 106-107, 174-175
light-emitting diode (LED), 141, 174-175
light energy, 61, 62
light water reactors, 151
lighting, electric, 175, 190
lightning, 32-33, 51, 198
lights, fluorescent, 92-93, 106-107
liquefied natural gas (LNG), 149
lithium batteries, 125
LNG (liquefied natural gas), 149
loads, 61, 62, 73, 136, 182, 187
loops, 99, 121, 122, 148
low potential electricity flow, 16, 46-47
low power factor, 113

- low-temperature resistance, 89, 104
- luminescence, 90-93, 106-107, 175
- M**
- magnetic fields, 94-98, 100, 107-109, 111, 114, 121, 148
- magnetism, 94-97, 107-108, 110, 111
- magnets, 94, 107, 110, 111
- manganese dioxide, 132, 134
- manganese dry cell batteries, 125, 131, 132, 134
- mega-, 46
- metal-oxide semiconductor field-effect transistors (MOSFETs), 189
- metals
- aluminum, 88-89, 140
 - bi-metal thermostats, 191
 - copper, 34-35, 41-42, 47-48, 51
 - properties of, 35
 - steel, 41-42, 51
- mho. See siemens per meter (S/m)
- micro-, 46
- microwaves, 91
- milli-, 46
- mobile phones, 175
- moderators, 151
- MOSFETs (metal-oxide semiconductor field-effect transistors), 189
- motion, 73
- motors, 98-99, 101, 109, 110, 190
- mutual induction, 114
- N**
- negative electrical properties, 27-28, 31, 166
- negative ions, 127
- negative poles, 46-47, 73, 132, 140, 171, 177-178
- negative temperature coefficient (NTC) thermistors, 192
- neutrons, 27, 47-48
- newtons (N), 49
- non-contact type sensors, 191
- north magnetic pole, 94-95, 99, 100-101, 107, 110, 111, 121-122
- NPN-type transistors, 177-178, 188
- NTC (negative temperature coefficient) thermistors, 192
- N-type semiconductors, 166, 169-171, 172
- nuclear
- fission, 147, 151
 - power generation, 120, 147, 151-152
 - reactors, 147, 151
- nucleus, 26-27, 34-35, 47-48
- nylon, 41-42, 51
- O**
- Ohm, Georg Simon, 73
- ohms (Ω), 62, 73, 77, 162
- Ohm's law, 67-68, 76
- oil (as fuel), 147, 149, 150
- optical sensors, 192-195
- outermost shells, 35, 47, 48, 165
- outlets, 23-24, 63-64, 123, 149
- oxidizing agents, 131
- P**
- paper, 41-42, 51
- parallel circuits, 79
- parallel connections, 69-72, 79-80
- peak voltage, 75-76, 123, 149
- Peltier device/effect, 144
- Pelton wheel, 153
- phase difference, 113
- phosphorus, 168
- photoconductivity, 193, 195
- photodiodes, 193-194
- photoelectric effect, 192, 195
- photoemission effect, 195
- phototransistors, 193, 195-196
- photovoltaic effect, 193
- physical cells, 124-125
- pico-, 46
- plugs, 24, 63-64
- P-N junction, 169, 170, 174, 193
- PNP-type transistors, 177-178, 181, 188
- polarization, 41, 131
- polyester, 41-42, 51
- polyethylene, 41-42, 51
- positive electrical properties, 27-28, 168
- positive ions, 127
- positive poles, 46-47, 61, 73, 132, 171, 177-178, 179
- positive temperature coefficient (PTC) thermistors, 192
- potential barriers, 170-171
- potential difference, 15-16
- power generation
- dam-type, 152-153
 - hydroelectric, 120, 147
 - nuclear, 120, 147, 151-152
 - thermal, 120, 147, 149-152
 - wind, 154
- power lines, 20
- power (P), 17-18, 19, 45, 46
- power plants, 20, 120, 147-154
- power supplies, 63-64, 72, 182
- alternating current, 114, 121, 123, 186
 - batteries, 63-64, 124-125
 - direct current, 74
 - voltage, 60-61, 62, 73-74, 78, 115
- power transistors, 188
- pressurized water reactors, 151-152
- primary cells, 124-125
- primary sides, 114
- primary voltage, 115
- propeller wind turbine, 154
- protons, 27, 29, 34, 47-48
- PTC (positive temperature coefficient) thermistors, 192
- P-type semiconductors, 168, 169-171, 172
- PVC (vinyl), 37, 39, 41-42, 51
- R**
- radio waves, 91, 106
- rated current, 23

- reactors
 - boiling water, 151-152
 - light water, 151
 - nuclear, 147, 151
 - pressurized water, 151-152
- rectification, 170, 173
- red light, 91, 106
- reduction-oxidation (redox), 132
- refrigerators, 190, 192
- repulsion, force of, 49-50, 97
- resistance (R), 61-62, 67-74, 76, 77, 79-80, 85, 88-89, 104, 105, 182
- resistancies, connecting, 69-72, 78-80
- resistivity (ρ), 77, 162
- resistors, 183
- reverse-bias voltage, 171, 193
- reverse-direction voltage, 187
- reverse electromotive force, 130
- rice cookers, 22
- rubber, 41-42, 51

- S**
- safety breakers, 21-23
- secondary cells, 124-125
- secondary sides, 114
- Seebeck effect, 142-144
- self-inductance, 112
- semiconductors, 30, 163, 166-171, 172
 - devices, 160-164, 161, 163, 169, 176, 183, 188-189
- sensors
 - contact-type, 191
 - defined, 190
 - non-contact-type, 191
 - optical, 192-195
 - temperature, 190-192
- series connections, 69-72, 78-80
- shocks, electric, 40, 66
- Siemens, Ernst Werner von, 77
- siemens per meter (S/m), 77
- silicon, 163-166, 167
 - crystals, 165, 168
 - dioxide, 164
- silk, 41-42, 51
- single electrons, 48
- single-phase alternating current, 189-190
- SI prefixes and units, 46
- size, current, 52
- smoothing capacitors, 187
- sodium hydroxide, 135-136
- solar
 - batteries, 125
 - cells, 125, 193
 - energy, 124-125
- sound, 73
- source, 189
- south magnetic pole, 94-95, 99, 100-101, 107, 110, 121-122
- speed, current/electron, 53
- static electricity, 25, 29, 32, 36-40, 49-53
 - electrostatic force, 29, 43, 49-50
 - triboelectric series, 51-53
 - uses of, 43-44
- steam engines, 45
- steam generation, 149, 150
- steel, 41-42, 51
- sulfuric acid, 127, 129
- sum of reciprocals, 70-71
- superconductivity, 88, 105
- supply voltage, 46-47
- switches, 59, 60-61, 73, 74, 176, 181-182
- symbols
 - amperes/amps (A), 16, 45, 68
 - charges (Q), 49
 - conductance (G), 77
 - coulombs (C), 45, 49-50, 104
 - current (I), 16, 143
 - farads (F), 115
 - giga- (G), 46
 - hertz (Hz), 65, 75, 122, 149
 - joules (J), 45, 46, 104
 - kilo- (k), 46
 - kilowatt hours (kWh), 18-19, 46
 - micro- (μ), 46
 - milli- (m), 46
 - mega- (M), 46
 - newtons (N), 49
- ohms (Ω), 68, 73, 77, 162
- pico- (p), 46
- power (P), 17-18, 19, 45, 46
- resistance (R).
 - See resistance (R)
- resistivity (ρ), 77, 162
- siemens per meter (S/m), 77
- tera- (T), 46
- time (t), 52
- units and SI prefixes, 46
- voltage (V). See voltage (V)
- volts (V), 15, 17-18, 45, 68
- watt seconds (Ws), 46, 104
- watts (W), 17, 45

- T**
- tags, consumer electronic, 45
- tea kettles, 14, 18, 22
- temperature sensors, 190-192
- tera-. 46
- Thales (philosopher), 25
- thermal
 - emission, 90-93, 106
 - energy, 106, 124
 - power generation, 120, 147, 149-152, 149-154
 - vibration, 87-90, 104-105
- thermistors, 191-192
- thermocouples, 143
- thermoelectric phenomena, 144
- thermopiles, 125, 141-143
- thermostats, 191
- time (t), 52
- toasters, 74
- traffic signals, 175
- transformation ratio, 115
- transformers, 20, 114-115
 - stations, 20
- transistors, 163, 176-183, 183, 188-189
 - amplification, 181
 - bipolar, 188
 - field-effect, 188-189
 - junction, 188
 - MOSFET, 189
 - phototransistors, 193, 195-196
 - PNP-type, 177-178, 181, 188
 - power, 188

triboelectricity, 38
triboelectric series, 40-43, 51-53
turbine engines, 147, 149,
152, 153

U

UHF waves, 91
ultraviolet rays, 91, 93, 106, 107
United States, voltage in, 45
utility pole transformers, 20

V

valence electrons, 34-35, 48,
165-166, 167
valence shells, 48
VHF waves, 91
vinyl (PVC), 37, 39, 41-42, 51
violet light, 91, 106
visible light, 91, 93, 106
Volta, Alessandro, 45, 126
voltage (V)
100V, 14, 45
120V, 22, 45, 72, 75, 76, 80,
123, 149
170V, 75, 76, 149
240V, 45
changes in, 20
defined, 15, 45, 46-47
effective, 75-76, 123, 149
in electrical appliances, 19,
24, 45, 46, 71-72, 96,
123, 190
forward bias, 173, 174
instantaneous, 75-76
international differences, 45
peak, 75-76, 123, 149
positive and negative poles,
46-47, 61, 73, 132, 171,
177-178, 179
potential and, 46-47
power supply, 60-61, 62,
73-74, 78, 115
reverse-bias, 171, 193

reverse-direction, 187
supply, 46-47
voltaic cells, 125
volts (V), 15, 17-18, 45, 68

W

water
cells, 135-137
current, 181
levels, 15-16
turbine, 147, 152, 153-154
wheels, 17, 59-60
Watt, James, 45
watt seconds (Ws), 46, 104
watts (W), 14, 17, 19, 45
waveforms, 187
wavelength, 91, 106
waves
electromagnetic, 91, 106-107
radio, 91, 106
UHF, 91
VHF, 91
wind power generation, 154
wires
coils, 108, 111-115
copper, 31, 104, 128
electric, 74, 77, 88, 96, 107,
108, 148
wood, 41-42, 51
wool, 41-42, 51

X

X rays, 91

Z

Zener diodes, 187-188
zinc
chloride, 132
ions, 129
plate, 126, 127, 128
powder, 133

