

# Water from Small Dams

**A handbook for technicians, farmers and others on site investigations, designs, cost estimates, construction and maintenance of small earth dams**



An oval-shaped charco dam on the flat plain west of the Usambara Mountains in Tanzania.



A circular hillside dam in the hilly land of Machakos in Eastern Kenya.



A spillway is being excavated for the manual construction of a valley dam with a straight embankment in a narrow part of a valley near Lake Victoria in Western Kenya.

**Erik Nissen-Petersen**  
for  
**Danish International Development Assistance (Danida)**  
2006

## Technical handbooks in this series:

### Titles

- 1 **Water for rural communities**
- 2 **Water supply by rural builders**
- 3 **Water surveys and designs**
- 4 **Water from rock outcrops**
- 5 **Water from dry riverbeds**
- 6 **Water from roads**
- 7 **Water from small dams**
- 8 **Water from roofs**

### Contents

Lessons learnt from Kitui pilot projects  
Procedures for being rural contractors  
Survey, design and cost of water projects  
Rock catchment tanks, masonry and earth dams  
Wells, subsurface dams, weirs and sand dams  
Rainwater harvesting from roads  
Ponds and small earth dams built manually  
Various types of roof catchments for domestic use

These handbooks can be obtained free of charge by either collecting them from the office of ASAL Consultants Ltd., or by paying through bank transfer the cost of sending the manuals by courier. For further details, please contact: [asal@wananchi.com](mailto:asal@wananchi.com) with copy to [asalconsultants@yahoo.com](mailto:asalconsultants@yahoo.com)

**Published by**  
**ASAL Consultants Ltd. for**  
**the Danish International Development Assistance (Danida) in Kenya**

**Text, drawings, photos by**  
**Erik Nissen-Petersen**

**Computer drawings and tracing by**  
**Catherine W. Wanjihia**

**Proofs and editing by**  
**Prof. Elijah K. Biamah, Amin Verjee and Steen S. Larsen**

**Printer**  
**Modern Lithographic (K) Ltd., P.O. Box 52810-00200, Nairobi, Kenya**

**Website by**  
**Edwin Ondako**

**Distribution by**  
**ASAL Consultants Ltd., P.O. Box 739, Sarit 00606, Nairobi, Kenya**  
[asal@wananchi.com](mailto:asal@wananchi.com) [asalconsultants@yahoo.com](mailto:asalconsultants@yahoo.com)  
**Fax/Tel : 254 020 2710296 Mobiles: 0733 619 066 and 0722 599 165**  
**Website : [www.waterforaridland.com](http://www.waterforaridland.com)**

© Copyright.

The copyright of the handbooks in this series is the property of the Royal Danish Embassy in Kenya. Downloading from the Internet and photocopying of the handbooks is permitted provided the source is acknowledged.

## Contents

<b>Acknowledgement</b> .....	vii
<b>Disclaimer</b> .....	vii
<b>Foreword</b> .....	viii
<b>Technical vocabulary</b> .....	ix
<b>Illustrations of technical terms</b> .....	x
<b>Measurements and conversions</b> .....	x
<b>Chapter 1. Introduction to small dams</b> .....	1
1.1 Purpose and Scope of this handbook .....	1
1.2 Types of small dams .....	1
1.3 Constraints and limitations .....	6
1.4 Other considerations .....	6
<b>Chapter 2. Considerations before construction</b> .....	7
2.1 Feasibility and planning for small earth dams .....	7
2.2 Considerations before building small earth dams .....	7
2.3 Water quality and health .....	7
2.4 Water requirements .....	8
2.5 Total water storage requirement .....	10
2.6 Economic feasibility .....	10
2.7 Estimating the benefits of dams .....	11
2.8 Determining the most cost-effective option .....	12
2.9 Determining the cost and benefit of a hand-dug well .....	12
2.10 Other considerations .....	13
2.11 Environmental impact .....	14
<b>Chapter 3. Community participation and management</b> .....	14
3.1 Community involvement .....	14
3.2 Gender issues .....	14
3.3 Ownership .....	15
3.4 Legal requirements .....	15
3.5 Specific local issues .....	16
<b>Chapter 4. Charco dams</b> .....	17
4.1 Site selection .....	17
4.2 Design .....	18
4.3 Marking out a charco dam .....	20
4.4 Construction .....	21
4.5 Constraints .....	21
<b>Chapter 5. Hillside dams</b> .....	22
5.1 Site selection .....	22
5.2 Design .....	22
5.3 Construction .....	26

<b>Chapter 6. Valley dams</b> .....	30
6.1 Legal requirements .....	30
6.2 Financial viability .....	30
6.3 Site criteria .....	32
6.4 Measurements to be taken of a dam site .....	33
6.5 Design .....	34
6.6 Soil for dam walls .....	36
6.7 Data for designing valley dams .....	39
6.8 Bill of Quantities (BQ) and costs .....	40
6.9 An example of a complete design .....	44
<b>Chapter 7. Construction of a valley dam</b> .....	45
7.1 Check list before starting construction work .....	45
7.2 The key .....	45
7.3 Foundation .....	46
7.4 Draw-off pipe .....	47
7.5 Spillways .....	48
7.6 Borrow pit .....	49
7.7 Building the dam wall .....	49
7.8 Completing the construction of an earth dam .....	50
<b>Chapter 8. Protection of reservoir and catchment area</b> .....	51
8.1 Reservoir protection .....	51
8.2 Catchment protection .....	52
<b>Chapter 9. Repair and maintenance</b> .....	55
9.1 Leaking dam reservoirs .....	55
9.2 Washed-out dam walls .....	56
9.3 Washed-out spillways .....	57
9.4 Silted-up dam reservoirs .....	57
<b>References</b> .....	58

## Acknowledgments

Much gratitude is due to Birgit Madsen of the Royal Danish Embassy in Nairobi for having taken a leading role in documenting the experiences of various techniques of creating low-cost water supply structures in the semi-desert, arid and semi-arid regions of the world.

Many thanks are also due to Prof. Elijah Biamah, John Gould, Steen Larsen and Amin Verje, who assisted with the text and editing, to Edwin Ondako who created the website and loaded this handbook and others onto it, and to Oliver D’Cunha, who managed the printing at Modern Lithographic.

Thanks are also due to the many engineers, technicians, artisans and self-help groups who participated in several training courses and other assignments on small earth dams implemented by ASAL Consultants Ltd. for Danida, SIDA, UNDP, EU and other organisations in a dozen countries over the last three decades.

This handbook, *Water from Small Dams*, is one of a series of 8 publications on *Water in Arid Land*, financed by the Danish International Development Assistance (Danida).

To promote the simple technologies described in the handbooks, they can be read, or downloaded free of charge, from our website [www.waterforaridland.com](http://www.waterforaridland.com).

Erik Nissen-Petersen  
Managing Director  
ASAL Consultants Ltd.  
P.O. Box 739, 00606, Nairobi, Kenya  
Tel/fax 254 (0)20 2710296  
Mobile 0733 619066 / 0722 599144  
[asal@wananchi.com](mailto:asal@wananchi.com) [asalconsultants@yahoo.com](mailto:asalconsultants@yahoo.com)

## Disclaimer

The designs and construction procedures described in this handbook are based on the author’s experiences and observations over 30 years. The earth dams described herein, when properly constructed and maintained, have performed exceptionally well. However, local climatic, geological, seismic and soil conditions vary widely, as does the quality of materials and workmanship, and while the author and Danida are keen to encourage the replication of the ponds and dams described in this handbook, they cannot accept liability for the failure of a water harvesting system based on the designs and construction procedures described here.

## **Foreword**

This handbook on water from small dams by Danida in Kenya has been produced at a time when Kenya through the newly restructured Ministry of Water and Irrigation has established Regional Water Services Boards whose mandate now includes that of designing and constructing small dams for rural water supply. Indeed small earth dams as water sources are needed most in arid and semi arid lands where fresh water supply is a priority for vulnerable pastoralist communities. Besides the provision of water for domestic needs, small earth dams otherwise also referred to as water pans are good water sources for livestock.

Water from Small Dams is a handbook that is expected to serve as a guide for technicians and water users who are contemplating to design and construct small earth dams. It emphasizes the need for feasibility studies during the planning stage and also delves into other considerations before construction. Options for water supply are provided by some descriptions of various types of dams such as charco dams, hillside dams and valley dams. The issues of concern in planning for small earth dams such as design, construction and maintenance, bill of quantities and constraints/limitations have been discussed as well.

This handbook provides insights into site investigations, designs, cost estimates, legal aspects and construction and maintenance of small dams. This information is required by local technicians for planning and constructing small dams. Conditions of ownership and other water related legal issues and the significance of environmental impact assessments are discussed in the handbook. Photo illustrations and diagrams make the information more comprehensive and easily understood by any reader.

It is with the understanding of the information contained herein that wise decisions can be reached when choosing the right type and size of small dams for given local environmental conditions. Finally, this handbook does underscore the importance of water sanitation through catchment and reservoir protection. This would ensure that there is quality and quantity in constructed small earth dams.

Julius Kiptarus  
Director of Livestock Development  
Ministry of Livestock and Fisheries Development

## TECHNICAL VOCABULARY

ASAL	=	Arid and Semi-Arid Lands
ASALCON	=	ASAL Consultants Ltd.
Batter	=	Gradient of a dam wall
Bench mark (BM)	=	A fixed point for taken measurements
Berm	=	Area between a reservoir borrow pit and dam wall
Base	=	Foundation for a dam wall
Borrow pit	=	An excavation from where soil is taken
Bill of Quantities (BQ)	=	List of materials and labour, with costing
Catchment	=	Area draining rainwater run-off to a common point
Centre line	=	An imaginary line through the centre of a crest at the upper level of the freeboard
Contour line	=	Horizontal line connecting points of equal altitude
Crawler	=	Bulldozer
Crest	=	Top of dam wall
Danida	=	Danish International Development Assistance
Diaphragm	=	Blanket of soil on upstream side of embankment
Downstream batter	=	Downstream slope of a dam wall
Downstream toe	=	Downstream edge of a dam wall
Draw-off pipe	=	Pipe draining water by gravity
Embankment	=	Dam wall
Evaporation	=	Water lost as vapour from a water surface
EU	=	European Union
Freeboard	=	Safety height of dam wall from maximum water level
Gradient	=	Slope
Hafir (Arabic term)	=	A type of earth dam for livestock and people
Inselberg	=	A massive bare rock outcrop common in the tropics
Impervious	=	Not letting water through
Key (Cut-off trench)	=	Trench of clayey soil to prevent seepage
Live fencing	=	Fence of vegetation, preferably thorny
Murram	=	A clayey soil packed with stones found under laterite soil
Seepage	=	Water seeping through soil
Sediment	=	Soil deposited in reservoir
Settlement	=	Soil compacting and shrinking in height due to weight
SIDA	=	Swedish International Development Assistance
Sill	=	Low concrete wall across spillway
Siltation	=	Dam reservoirs being filled with silt
Siphon	=	Pipe lifting water over a high point to a lower level
SODIS	=	SOLar DISinfection (of water)
Spillway	=	Overflow channel discharging excess floodwater
Storage ratio	=	Volume of water in relation to volume of soil
Turbid	=	Muddy, unclear water carrying sediment
Throw-back	=	Length of a reservoir full of water
Topographical	=	Relating to the shape and height of the land
UNDP	=	United Nations Development Programme
Upstream batter	=	Upstream slope of a dam wall
Upstream toe	=	Upstream edge of a dam wall
Valley dam	=	Dam constructed in a valley with a straight embankment
Washout	=	Section of a dam wall washed out by water

## ILLUSTRATION OF TECHNICAL TERMS

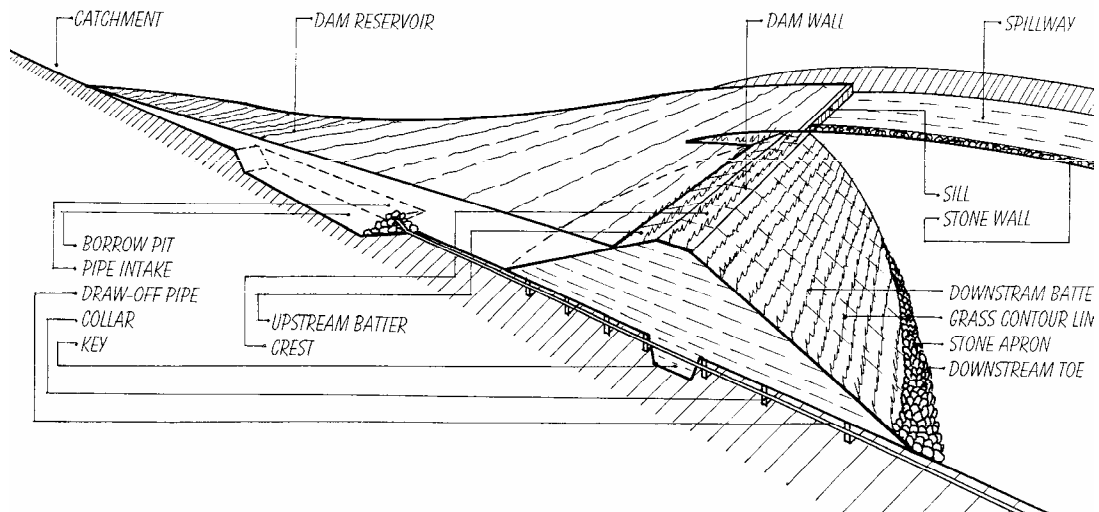

Cut-through section of a three-dimensional sketch of a dam wall.

## MEASUREMENTS AND CONVERSIONS

**Length**      1 metre = 3.28 feet  
                   1 km     = 0.62 miles

**Area**            1 acre = 4,047 m<sup>2</sup>                    = 0.4047 hectares (ha)  
                   1 ha     = 10,000 m<sup>2</sup>                   = 2.471 acres  
                   1km<sup>2</sup> = 100 ha                            = 247.1 acres

**Volume**        1 litre = 1.75 pints                   = 0.22 Imp gallons (or 0.26 US galls)  
                   1 m<sup>3</sup> = 1,000 litres (l)           = 220 Imp gallons (or 260 US gallons)  
                   1 Imperial gallon                   = 4.550 l  
                   1 US gallon                            = 3.785 l

**Weight**         1 tonne                                 = 1,000 kg  
                   1 British ton                           = 1,016 kg  
                   1 US ton                                = 907 kg

### Volumes and weight of materials

1 m<sup>3</sup> water                               = 1,000 kg  
 1 m<sup>3</sup> dry soil                           = 1,230 to 2,000 kg  
 1 m<sup>3</sup> compacted soil                 = 2,180 kg, approximately  
 1 m<sup>3</sup> loose gravel                      = 1,745 kg, approximately  
 1 m<sup>3</sup> stones                              = 2,400 kg to 2,900 kg

### Exchange Rate Used in the Manual

Ksh                 = Kenya Shillings  
                   Ksh 73            = US\$ 1.00 (August 2006)



# Chapter 1. Introduction to small dams

## 1.1 Purpose and scope of this handbook

The purpose of this handbook is to provide a guide to communities, technicians, farmers and others who are considering developing a water source for agricultural, livestock watering or domestic purposes. Various options are discussed and the development of ponds and small earth dams covered in detail. Guidance is provided on site investigation, design, construction, maintenance and repair.

The handbook also deals with other important aspects of these water projects including environmental impact (the effect on nature), community participation and management, legal requirements, ownership and gender issues.

Since site investigations, design and construction of medium and large size earth dams require experienced engineers and should not be constructed by field technicians and farmers, they are not included in this handbook.

***A word of warning: It must be remembered that the construction of any dam does carry with it a small risk of failure. If the possible collapse of any dam threatens either property or life then experienced technical advice should be sought.***

## 1.2 Types of small dams

Small earth dams are the subject of this handbook which covers the design and construction of small earth dams with storage capacities up to about 10,000 cubic metres and having embankments up to a height of about 5 metres. Small earth dams can be built manually, using animal draught, a farm tractor, a crawler or bulldozer.

The three types of small earth dams seen on the front page are covered in the following chapters of this handbook:

- 1) ***Charco dams*** for almost flat land, are described in Chapter 4.
- 2) ***Hillside dams*** for rolling and hilly land, are described in Chapter 5.
- 3) ***Valley dams*** for seasonal water courses and valleys are described in Chapter 6.

However, since the word ***dam*** is often used for almost any type of water reservoir built of soil, it might to advantageous to have a look at the various types of dams.

***Small earth dams*** are often called ***ponds***. Their water reservoirs are constructed by excavating a depression for the water reservoir and depositing the excavated soil on the lower side of the water reservoir as an embankment that will increase the storage volume of the excavated water reservoir.

In addition to the three types of small earth dams described in detail in this

handbook, there are also other types of so-called dams which can be classified as pans.

**Pans** are natural depressions in the ground where rainwater gathers. Pans do not rely on excavations or embankments to trap runoff. Pans form in natural depressions in which rainwater accumulates during rainy seasons. Wildlife, livestock and man have shared this water source since the beginning of life on this earth.



In the Kalahari Desert large natural **salt pans** are found. They have been formed by wind action and usually only hold water for a few months a year.

The square hole with water seen in the photo has been excavated into the salt pan for extraction of salt.



Smaller natural pans including the **Silanka ya Ndovu** (elephant dam) are common in arid and semi-arid lands (ASAL) where they have been scooped out by elephants. The floors of pans are almost watertight, as animals trample and compact the soil and droppings, when they enter the pans to drink.

Pans are used for watering livestock during rains and a few months thereafter. Some people also use them for domestic water supply, even though the water is dirty and not suitable for drinking water or washing.



Although it may not always be worthwhile to build new pans, it is sometimes worthwhile deepening or enlarging existing natural pans or creating artificial ones. Farmers in particular appreciate the benefits that natural pans can bring, even though most are seasonal and cannot store water throughout the year.

**Borrow pits**, also called **murram pits**, are found along roads. They are made when murram is dug up for road construction. These pits fill with runoff from the road during rains. While borrow pits usually seem unattractive and unproductive, they can be converted into useful small dams for livestock, irrigation and fish ponds. This is because:



- Most borrow pits are dug in firm laterite soil, with little seepage, and are capable of storing water for long periods.
- Even small rain showers can fill borrow pits with water, because the road next to the pit typically has a large surface from which runoff can easily be diverted into the pits, by digging a trench sloping from the road into the pit.

Since rainwater run-off from roads may contain tar, animal manure and other pollutants, water taken from borrow pits should not be used for human consumption.

Watering livestock in borrow pits might be a hazard to traffic. It is therefore appropriate to fence off the water reservoir with thorny vegetation. It might be necessary to seek permission from the relevant authorities, if borrow pits are planned to be converted into ponds for irrigation and other commercial activities.

**Ground tanks** are excavated near homesteads for growing fruit trees and irrigating gardens. Ground tanks may be square, as this one in Tanzania pictured on the right, although the most efficient shape is a bowl-shape, because it is a stable form that distributes internal and external pressure equally on the tank wall. In addition, the shape has the advantage of giving maximum water volume for a minimum excavation of soil.



Where soils are sandy, tanks have to be plastered to prevent seepage. A cheap plaster can be made by mixing cement with powdered ant-hill, lime and sand in the ratio of 1:8:2:8 and reinforced with chicken mesh and coated with bitumen. Ground tanks can also be lined with burnt bricks or ferro-cement, but these cost more.



**Berkads** are ground tanks that are excavated and lined with concrete blocks or ferro-cement in the semi-desert regions of Somaliland. Rainwater is diverted into the berkads by soil or stone bunds sloping upwards from berkads on hillsides.



Silt traps, as seen in the lower photo, are made as small berkads before water flows into the water reservoir.

Strangely, the standard design of most berkads is rectangular with vertical walls that crack due to external pressure of the soil when the berkads dry up. The much stronger circular and oval-shaped design was only observed in a few places. The construction of new berkads in Somaliland is said to have been banned, as over-grazing by the livestock that are watered at the berkads causes desertification.



**Hafirs** are ponds dug into natural depressions in some parts of Sudan's plains. Soil removed from the hafirs can be used to form banks surrounding the reservoir to increase its volume. Hafirs typically range in size from 500 to 10,000 cubic metres and provide water for both livestock and domestic purposes. In the past most hafirs were dug by hand, but today heavy machinery is used when building larger hafirs.

**Charco dams**, also known as Milambo in Kiswahili, are explained in Chapter 4 of this handbook and shall therefore not be described in this chapter.

**Check dams** are built across gullies to check, or impede, the enlargement of the gullies by trapping sediment, which helps to reduce or even reverse soil erosion. The sediment gradually refills gullies and can be used to help improve soil fertility on adjacent farmland. Check dams can be constructed using either stones packed in gabions or sacks filled with soil and placed across a gully.



Rain-water trapped behind the dam in 'gully ponds' also creates a small temporary water source. Usually, such ponds have a short life-span as a water source, if the check dam is effective at refilling the gully.

**Rock catchment dams** can either be built on a rock surface with a masonry wall, or be an earth dam built at the foot of a rock outcrop, as seen in this photo. More details can be found in *Water from Rock Outcrops*.



**Sub-surface dams** are built in riverbeds and have dam walls built of soil that stretch across the riverbed in seasonal water courses with sand, also called sand rivers, dry riverbeds, luggahs, wadis, etc.

Sub-surface dams block floodwater that has infiltrated into the voids between the sand particles. Up to 35% of water can be extracted from the voids in coarse sand, but much less from fine structured sand. This form of water storage has the advantage of protecting the water from evaporation as well as helping to protect it from contamination.



**Weirs**, built of stone masonry or concrete function as subsurface dams, but can store more water because they can be built up to 50 cm above the surface of the surrounding sand. The higher capacity of water supply does, however, come at a higher cost due to the cement required for the masonry work.



**Sand dams** are structures larger than weirs, which can be raised to several metres above the sand surface of seasonal water courses and gullies. Although sand dams can produce much more water than sub-surface dams and weirs, most of them do not function well, due to their complicated design, construction and maintenance.



The above three types of dams in riverbeds are described in *Water from Dry Riverbeds*.

### 1.3 Constraints and limitations

Although the dam designs in this handbook are appropriate in ASAL areas, they suffer from a number of constraints common to this environment. These include:

- 1) Low and erratic rainfall and prolonged droughts over several years of below average rainfall may lead to reservoirs failing to fill.
- 2) High evaporation rates leading to significant losses from any water stored in open reservoirs or ponds.
- 3) Siltation due to large amounts of sediment washed into reservoirs during severe storms, especially at the end of the dry season, which also make the water turbid. Siltation can be avoided by trapping inflowing silt in silt traps and utilizing it for fertilising garden plots.
- 4) Contamination of water in open reservoirs can be caused by livestock entering reservoirs resulting in poor water quality. Livestock should therefore be watered downstream of dam reservoirs, where water can be drawn from a hand-dug well sunk in an area with seepage from the dam reservoir. Clean water for domestic use can also be drawn from such a well.
- 5) The risk of small children and livestock falling into ponds or reservoirs. *Small water reservoirs should therefore always be fenced.*

### 1.4 Other considerations

All types of pits, tanks, ponds and dams should be situated at the lowest point in the locality, so rainwater runoff flows naturally towards the water reservoir by gravity.

The catchment area, that collects rainwater, can consist of any compacted soil surface such as the compounds around homesteads or school playgrounds. Road surfaces, or rock outcrops, may also make suitable catchments. Rainwater run-off can also be diverted from a nearby gully, provided the reservoir is situated at a lower elevation than the gully.

Water reservoirs should be covered, or fenced to prevent people and livestock from falling into the water.

Small water reservoirs can be roofed to reduce evaporation by roofs made of sisal poles. Useful creepers, such as Passion fruit and Luper, can be grown on the roof to further reduce water loss by evaporation.

Uncovered tanks should have in-built steps that can be used for drawing water, and to minimize the risk of children or adults falling into the tanks and not being able to get out again.

A fish, *Tilapia Nilotica*, that feeds on mosquito larvae, can be raised in borrow pits to reduce the risk of malaria. Mudfish, which can survive even when small dams dry up, can also be raised to increase food supply and cash income.

## **Chapter 2. Considerations before construction**

### **2.1 Feasibility and planning for small earth dams**

Before proceeding with any water project, however small, it is important to first determine whether it is feasible. This not only involves determining its' technical and economic viability, but also its' environmental and social impacts. It is important that these can be shown to be generally positive.

Further, any project that involves the community needs their full support. When considering the feasibility for any project it is important to establish that the community has the motivation and capacity to plan, implement, operate and maintain it. The best projects are usually those identified by community groups and implemented by community members. This instils a greater sense of ownership by the community, who are then more likely to engage in the active maintenance of the dam, reservoir and catchment area.

### **2.2 Considerations before building small earth dams**

Before constructing a small earth dam, or any type of communal water source, it is vital to confirm that the project is viable. To determine this it is helpful to ask a few key questions at the outset, such as:

- Will the water be clean enough, and if not, can the quality be improved?
- How much water is needed?
- How much water will the new source provide?
- What will the project cost and is this affordable?

### **2.3 Water quality and health**

The rainwater runoff which fills small water reservoirs usually flows over the ground that is contaminated. Catchment areas are often covered with animal droppings, human excreta and other debris that can pollute the water.

While this water is suitable for watering livestock, or for small scale irrigation, and construction work, it is not safe for drinking. If the purpose of a small dam is to get clean water for domestic purposes, then the water should be drawn from a hand-dug well sunk in a seepage line downstream of the dam wall.

Drinking untreated water from open water sources is not recommended, unless it has first been boiled, or sterilized by the sun's ultraviolet rays in a transparent bottle for 6 hours of sunshine. This technique is called SODIS (= SOLar DISinfection of water).

Drinking water that has not been treated by either boiling or SODIS may lead to waterborne diseases such as dysentery, diarrhoea or typhoid. If waterborne diseases, such as Schistosomiasis (Bilharzia) carried by water snails is present in the area, people should be discouraged from entering the water.

## 2.4 Water requirements

To estimate how much water is required and for how long, some simple calculations are required. The demand for water for domestic purposes, livestock and irrigation can be estimated as shown below.

In this case we assume that the stored water will be needed for a dry season of 180 days in an ASAL region, although this figure will vary in different localities. The following tables are examples of water use based on a family of 8 people, with 2 milk cows, 10 Zebu cattle, 14 sheep, 10 goats, 3 pigs and ¼ acre of land under drip irrigation.

In practice, to determine the water requirement for any particular household, or community, information on the number of people, livestock and any irrigation requirements need to be gathered. In many cases, due to the availability of better quality alternative water sources for domestic consumption from a hand-dug well, or rainwater tank, water from a dam or pond will only be required for livestock

### 2.4.1 Water for domestic use

In this example, the daily water use of a typical African household in a semi-arid location is taken as 14 litres/person/day, which is equivalent to 112 litres for a household of eight, or half an oil drum of water for each day. This volume is much higher than the actual 5 litres/person/day, commonly used for drinking and cooking in ASAL regions.

**Table 1. Example of water needed for a household in ASAL**

Number of persons	Daily consumption per person	Number of days without rain	Total water requirement
8	x 14 litres	x 180 days	= 20,160 litres

### 2.4.2 Water for livestock

The amount of water required by livestock will vary greatly depending on the season, temperature, moisture content of animal forage and type of animals. Table 2 shows the dry season requirements for various common types of livestock.

**Table 2. Example of water requirements for livestock in ASAL**

Type and number of livestock	Daily consumption per animal	Number of days without rain	Total water requirement
Milk cows 2	x 50 litres	x 180 days	= 18,000 litres
Zebu cows 10	x 27 litres	x 180 days	= 48,600 litres
Sheep 14	x 5 litres	x 180 days	= 12,600 litres
Goats 10	x 3 litres	x 180 days	= 5,400 litres
Pigs 3	x 10 litres	x 180 days	= 5,400 litres
<b>Total requirement for watering livestock</b>			<b>= 90,000 litres</b>

*Source of data:* Rain Catchment and Water Supply in Rural Africa, Nissen-Petersen, E. 1982 & Finkel and Segerros 1995 (RELMA Technical Handbook No. 22).

### 2.4.3 Water for irrigation



It is difficult to estimate the water requirement for irrigation because it depends on the type of irrigation method used, the soil type, climate, crop type and its growing period. For example, bucket irrigation of vegetables requires about double the volume of water required for drip irrigation. Table 3 illustrates the water requirement for tomato/kale production using drip irrigation on a 1/4 acre.

**Table 3. Example of water requirements for drip irrigation**

Type of irrigation	Type of crop	Daily Water requirement for 90 days on a 1/4 acre (approx. 1000 m <sup>2</sup> )	Total water requirement
Drip irrigation	Tomatoes/kale	1,000 x 90 =	90,000 litres
<b>Total requirements for drip irrigation of 1/4 acre is 90,000 litres</b>			

Source: Drip Irrigation Project, Kenya Agricultural Research Institute (KARI).

#### 2.4.4 Total water requirement

A reasonable estimate of the water demand that a pond or small earth dam may be expected to meet can now be worked out by simply adding together the total water requirements for domestic, livestock and irrigation in tables 1, 2 and 3.

**Table 4. Example of total water requirement for domestic, livestock and irrigation**

Domestic water for a household for 180 days	20,160 litres
Watering 35 animals for 180 days	90,000 litres
Drip irrigation of 1/4 acre for one growing season	90,000 litres
<b>Total water requirement</b>	<b>200,160 litres</b>

The total water requirement is estimated as 200,160 litres which can be converted into cubic metres by dividing the figure by 1,000 as follows; 200,160 litres / 1,000 = 200.16 cubic metres, say 200 m<sup>3</sup>.

#### 2.5 Total water storage requirement

To determine the total water storage requirement needed to meet a demand of 200 m<sup>3</sup> for ¼ acre per year two other factors, evaporation and seepage causing natural losses from any open reservoir need to be taken into account.

- Evaporation loss can remove up 2.5 metres depth of water per year from an open dam reservoir in a hot climate, although for a good estimate of this loss the evaporation rate in the specific location and the surface area of water must be known. A useful rule of thumb, is that about 50% of the water in a reservoir is lost each year to evaporation.
- Seepage loss is also difficult to estimate because dam reservoirs are built of various soil types which result in varying degrees of seepage. Nevertheless, another common rule of thumb states that seepage may account for about half that of evaporation (or 25% of the water in a reservoir).

On the basis of the above rules of thumb, it can be concluded that if 200 m<sup>3</sup> of water is required, then the water reservoir should have a storage capacity of 800 m<sup>3</sup> to cater for an evaporation loss of 400 m<sup>3</sup> and seepage loss of 200 m<sup>3</sup>.

**Table 5. Total estimated water storage requirement for the reservoir**

<b>Domestic, livestock and irrigation water usage</b>	<b>200 m<sup>3</sup></b>
<b>Estimated evaporation loss (50%)</b>	<b>400 m<sup>3</sup></b>
<b>Estimated seepage loss (25%)</b>	<b>200 m<sup>3</sup></b>
<b>Required storage capacity of water reservoir (100%)</b>	<b>800 m<sup>3</sup></b>

The data from table 5 shows that a reservoir needs to be four times as large as the estimated total water requirement to allow for evaporation and seepage losses.

## **2.6 Economic feasibility**

There is no point constructing an earth dam unless the benefits exceed the cost. Table 6 shows an example of the typical costs of constructing different types of water storage reservoirs of volumes ranging from 100 m<sup>3</sup> to 5000 m<sup>3</sup> using four methods of excavation, namely: a) manual by hand using only shovels and wheelbarrows, b) oxen to pull ox scoops, ploughs and carts, c) tractor with plough, scoop and trailer, and d) crawler or bulldozer. It can be seen from the table that larger dams and ponds work out much cheaper per cubic metre of water stored than smaller structures, especially when excavation is done using oxen.

**Table 6. Construction costs of excavated tanks, ponds and dams**

Type of Dam	Construction Method *	Reservoir volume m <sup>3</sup>	Water to Soil Ratio	Excavated Soil m <sup>3</sup>	Cost per m <sup>3</sup>	Total Cost Ksh.	Cost per m <sup>3</sup> of water storage Ksh.
Excavated tank	Manual	100	1:1	100	x 100	= 10,000	<b>100</b>
Charco dams	Manual	500	1:1	500	x 100	= 50,000	<b>100</b>
	Tractor	500	1:1	500	x 80	= 40,000	<b>80</b>
	Oxen	500	1:1	500	x 60	= 30,000	<b>60</b>
½							
Hillside dams	Manual	500	1.5:1	333	x 100	= 33,300	<b>66</b>
	Tractor	500	1.5:1	333	x 80	= 26,640	<b>53</b>
	Oxen	500	1.5:1	333	x 60	= 19,980	<b>40</b>
Valley dams	Crawler	5,000	3:1	1,670	x 300	=501,000	<b>100</b>
	Manual	5,000	3:1	1,670	x 100	=167,000	<b>33</b>
	Tractor	5,000	3:1	1,670	x 80	=133,600	<b>27</b>
	Oxen	5,000	3:1	1,670	x 60	=100,200	<b>20</b>

\* The construction method relates to whether the excavation is done: a) manually with shovels and wheelbarrows, or b) using draught animals with ox-scoops, ploughs and carts, or c) by hiring a crawler (bulldozer).

## 2.7 Estimating the benefits of dams

The main cost for a dam is paid at the time of construction, but the benefits can be calculated over the life of the reservoir of at least 10 years or more, assuming that it will eventually fill with silt.

Economic benefits will include the value of labour and time saved fetching water and watering livestock. Benefits may also result from improvements in the condition of livestock and small stock, cash from sale of irrigated farm produce and value of food grown for the household.

To estimate the economic feasibility of constructing a pond or dam it is helpful to estimate the value of the benefits, such as additional income, time and labour saved, and comparing these with the cost.

## 2.8 Determining the most cost-effective options

Table 6 shows that if suitable sites exist, the construction of valley dams is much cheaper than the construction of excavated tanks and ponds. This is because the least amount of material needs to be moved for each cubic metre of storage capacity created. The most expensive option is the manual excavation of tanks and ponds, because only one cubic metre of water storage capacity is created for each cubic metre of soil excavated. The cheapest construction method is to use oxen, with the cost being as low as Ksh 20 per cubic metre of storage capacity created, in the case of valley dams. This type of dam is, however, the most difficult for a community, farmer and/or water technician to construct.

Where technically feasible, the best option is a small hillside dam constructed with a reservoir volume of 500 m<sup>3</sup>. Although not the cheapest option for each cubic metre of

water storage capacity created, it is the most affordable. It will only cost Ksh19,980 if oxen are used. In one good rainy season it could potentially fill up with water, and could produce savings and cash income worth about Ksh 10,000. Thus it could pay for itself in just over two years, thus being a good investment of time and resources.

**Table 7. Annual value of benefits from a 500 m<sup>3</sup> water reservoir**

<b>Examples of Annual Income and Savings</b>	<b>Value in Ksh</b>
<b>Labour saved on fetching water ( Ksh 500 x 3 months )</b>	1,500
<b>Labour saved on watering livestock ( Ksh 500 x 3 months )</b>	1,500
<b>Income from sale of tomatoes and kale from ¼ irrigated acre</b>	6,500
<b>Value of household consumption of tomatoes and kale from ¼ acre</b>	500
<b>Total Income from a 500 m<sup>3</sup> water reservoir after a rainy season</b>	<b>10,000</b>

## 2.9 Determining the cost and benefit of a hand-dug well

Where water from a dam or a pond is to be used for domestic water, it should be drawn from a hand-dug well sunk in a seepage line downstream of a dam wall. This way contaminated water from the reservoir is filtered as it seeps through the soil. If this water is to be used for drinking it should always be boiled, or SODIS treated. An example of the estimated cost-benefit of a 6 metre deep hand-dug well is shown below

**Table 8. Cost-benefit of a hand-dug well**

<b>Expenditure</b>	<b>Ksh</b>
<b>Construction cost of a 6 metre well shaft equipped with windlass</b>	<b>30,000</b>
Sale of 20 jerrycans (20 litres) of water/day @ Ksh 5 x 20 x 216 days	<b>21,600</b>
Own consumption of 100 litres of water/ day @ Ksh 5 x 5 x 180 days	<b>4,500</b>
Less sick days by having clean water; Salary Ksh 100/day x 20 days	<b>2,000</b>
Saved medical expenses by having clean water; Ksh 50/day x 20 days	<b>1,000</b>
<b>Income from a hand dug well in 180 days</b>	<b>29,100</b>

The above example shows how to work out the pay back time for the one-time cost of building a 6 metre deep hand-dug well equipped with a windlass. In this case the cost is recovered in just 216 days. Thereafter the owner of the hand-dug well will be generating a daily income from selling water to neighbours. In addition, the owner as well as his neighbours will save working time on fetching water and suffer fewer sick days caused by water-borne diseases.

## 2.10 Other considerations

If the answers to the questions listed in section 2.2 suggest that the building of a dam may be technically and economically feasible, then the next questions are:

- Will the project have any major impact on the environment?
- What will the impact of the project be on local people and how are they involved in its planning and management?
- Does the project address issues which affect the roles and work of men and women in the community (gender issues)?
- Are there any laws, cultural or ownership issues associated with the project which need to be addressed?

## 2.11 Environmental impact

Before constructing a dam, the environmental impact must be evaluated. Small earth dams do not have a major impact, except if many small dams are constructed in the same catchment, in which case their combined effect could be significant. The impact can be both negative and positive. If the negative impacts exceed the positive impacts, the dam should not be constructed. The list below can be used as a checklist.

Positive impacts of earth dams and ponds	Negative impacts of earth dams and ponds
1. Irrigating fields and tree nurseries for generating income and re-planting forests	1. Loss of some land taken up by the dam reservoir and its spillway(s).
2. Watering livestock near villages saves time and reduces erosion caused by cattle.	2. Risk of increased cases of malaria (this can be reduced by fish such as <i>Tilapia Nilotica</i> ).
3. Providing domestic water from a hand-dug well generates income and can lead to health improvements.	3. Risk of increased cases of bilharzia, cholera, dysentery and typhoid (this can be reduced if the reservoir is fenced and the water is drawn from hand-dug wells or draw-off pipes situated downstream of dam walls, if drinking water is boiled and if people do not bathe in, and wash clothes in the reservoirs).
4. Raising ducks, geese and fish farming for food and income.	4. Increased soil erosion along roads due to people and animals coming for water at the dam.
5. Making bricks and construction works for income generation.	5. Risk of dam wall collapse if poorly designed or constructed incorrectly, thereby releasing a violent flash-flood damaging everything in its path.
6. Reducing water-borne diseases by providing improved water supply for domestic use.	6. Siltation of dam reservoirs will shorten the lifetime of dams unless proper soil conservation is implemented in the catchment areas.
7. Saving peoples' time by reduced walking distances to fetch water.	7. Risk of people and animals drowning if they try to bathe in or swim across a dam reservoir.
8. Reduced impact of floods by storing initial floodwaters thus lessening erosion.	8. Impact on downstream users who may be deprived of water or subject to pollution
9. Raising the water table downstream of ponds and dams which benefit well levels for hand-dug wells and trees.	
10. Increasing the value of land near an earth dam, because of all the above benefits.	
11. Reducing poverty levels through the income-generating activities	

## **Chapter 3. Community participation and management**

### **3.1 Community involvement**

If a small dam is being constructed for a community, the whole community must be involved in the location, design, construction and maintenance of the dam for several reasons, such as:

- 1) Common ownership of the water source will help to ensure that it is operated and maintained properly. It will also increase the likelihood that any communal benefits are shared in a fair way.
- 2) Community members are more likely to support any future calls to assist in repair or maintenance work, such as removal of sediment from the reservoir.
- 3) Even where the construction of dams is for single households, the inclusion of the nearby community members will encourage householders to assist each other in the heavy and tiring construction work.
- 4) Another benefit of involving the whole community from the start is that any potential issues or obstacles can be identified from the outset and appropriate action taken. This will help to avoid potential future problems.
- 5) Community members who will use a new dam should be involved in all aspects of planning and management in a participatory way. Important decisions such as the site of the dam should be taken at a village meeting. At such public meetings the community should be encouraged to elect a small committee to represent them and keep them informed.

### **3.2 Gender issues**

In most of the developing world the burden of carrying domestic water from the source (e.g. river, spring or hand-pump) to the home usually falls on women. The construction of small earth dams is therefore likely to have a positive impact on women, which may include a reduction in time and effort spent collecting water from distant sources.

If water from an earth dam reservoir is used for irrigating vegetables, or other crops that the women tend, there may be increased demands on their labour. It is therefore very important that women, as well as men, are included in all discussions relating to the project, right from the planning stage. It is also essential that women should be well represented on any water management committee set up to oversee the operation and maintenance of the scheme on a long-term basis.

### 3.3 Ownership

**Valley dams** are normally built across valleys and small seasonal water courses, which are often boundaries between two or more landowners. It is therefore important that the landowners sign a written agreement on sharing the ownership of the dam. This agreement should also include sharing of the construction cost, usage of water and maintenance of the dam. The agreement must be finalised before any survey and construction works take place.

Valley dams may interfere with people's water supply downstream. Since valley dams can collapse during exceptionally heavy rainfall due to poor maintenance, incorrect design or poor construction work, this could endanger people and structures downstream. For these reasons, approval for the design and permission for the construction works must be obtained from the authorities.

**Unhindered access** to a community valley dam must also be agreed upon in writing by the landowners concerned.

Usually, it is sufficient that landowners declare the land for a dam, and its access road, as "public land" during an official meeting with their Chief. However, a verbal declaration should be recorded in the Minutes of the meeting along with a supporting letter from the land-owners. This is necessary, because although the existing owners may agree, their sons and daughters, or future land-owners may disagree without such a written consent. In any case, it is wise to consult the office of the District Water Officer (DWO) or similar authority on the legal issues relating to ownership of water sources.

**Hillside dams and Charco dams** are less complicated because they are built on hillsides and flat land that is usually owned by just one person or family. Another advantage with these two types of earth dams is that they are not situated in seasonal watercourses and do not therefore affect people living downstream.

**Catchment protection** is also required to reduce soil erosion and siltation of dam reservoirs. The protection can consist of digging trenches, making terraces and planting of grasses or trees in rows along the contours. It also includes the building of check dams and silt traps in gullies. All land-users in a catchment area should be encouraged to participate in all the soil conservation activities, including the maintenance of structures and vegetation cover.

### 3.4 Legal requirements

Legal requirements vary from one country to another. It is always advisable to ask the authorities before starting any construction works in order to avoid disappointment and legal cases.

Generally, it is understood that farmers may construct ponds and small earth dams on their land without asking permission from anyone, provided they do not block water runoff to people living downstream.

**Borrow pits** along roads can be turned into water reservoirs by digging a trench or two for diverting run-off from a road into a borrow pit. Whether this is allowed depends on the local authorities in that region. Therefore it is better to ask before digging that trench, instead of being confronted by the authorities or fined afterwards.

**Subsurface dams, weirs and sand dams** built across small streams and dry riverbeds can easily be built using soil, sandbags or rubble stone masonry, thus damming and diverting water for various purposes. However care should be taken as plans for building such structures require approvals by the relevant authorities in most countries, because weirs may reduce the water supply for people living downstream.

### 3.5 Specific local issues

Past experience has shown that many projects fail for social rather than technical reasons. Failure may be because projects were poorly managed and lacked proper maintenance. This often occurs when it is unclear who is responsible to ensure routine inspection and maintenance as and when required. Local disputes over access or ownership of water systems are also a common problem.

To avoid this, the local community should be involved from the start of any project, both to plan and later to manage it. This ensures a sense of ownership by everyone involved. It also gives the community the opportunity to sort out any issues which could threaten the future of the project.

The small valley dam shown below was built manually by the author on his farm in the semi-arid Kibwezi area during two weeks in 1976. For the last 30 years, domestic water has been drawn from lined and unlined hand-dug wells downstream of the dam. An orchard and a small forest benefit from seepage from the dam reservoir, despite the surface water drying up in the water reservoir during long dry periods



Thousands of small valleys, as this one, could be turned into evergreen orchards and forests, while also supplying water all year round for domestic use, watering livestock and small-scale irrigation.



## Chapter 4. Charco dams

Farmers and cattle owners in semi-arid parts of Tanzania build small earth dams known as Charco, or Milambo in Kiswahili. These dams are built in a way which tries to reduce evaporation losses by deepening the water reservoirs and minimising their surface area. Trees and scrubs are grown on the windy site of the charco dams to function as windbreaks that also reduce evaporation.



A Tanzanian farmer (with cap) explains the benefits of his charco dam.

### 4.1 Site selection

The best sites for constructing charco dams are in natural depressions where rainwater either flows or accumulates during the rainy season. The soil should, preferably, be deep clay, silt or Black Cotton soil. Coarse textured sandy soils should be avoided as these are highly permeable and water will drain through them. If seepage is high in charco dams, they can be plastered with clayey soil and compacted using compactors made of tree trunks. The most suitable types of soil for dams are shown in Chapter 6.

Sites with underlying strata of sand, gravel, limestone or fractured rock at a shallow depth may also result in high seepage losses, unless they are sealed with clayey soil.

Ideally, a charco dam should be located near to a gully or a natural waterway, which carries water during and after rainfalls, as this water can easily be diverted into the dam. Avoid building dams near or downstream from livestock enclosures to avoid organic and/or chemical pollution.

Charco dams are usually excavated manually by individuals near their homesteads for watering livestock. The water may also be used for some domestic purposes, if it is boiled or treated by the sun's UV rays in transparent bottles (SODIS).

Farmers dig their ponds during dry seasons and enlarge them every year, until the owner is satisfied with the capacity of the dam.



A farmer is building his charco dam on the flat plain west of the Usambara Mountains in Tanzania.



Unfortunately, this farmer has only one shovel and 3 old jerrycans to excavate and transport soil.

## 4.2 Design

The most economical and perfect shape for a charco dam is that of a calabash cut in half and used for scooping water. The "handle" is used for the inflow channel and for giving access to people and livestock, while the "bowl" is the water reservoir.



The photo shows the inflow channel to a charco dam seen in the background. Usually, inflow channels have some logs laid across the floor of the inflow channel that function as steps and silt traps to prevent the water reservoir from being silted up.

Since there are no documented guidelines or training on constructing charco dams, the Tanzanian farmers build their dams in any shape, although circular and oval designs are preferred, because:

- 1) They give maximum storage volume for a minimum of work.
- 2) The internal and external pressures are evenly distributed and this prevents cave-in of the soil in the walls of the water reservoir.
- 3) In sandy soils, they can be lined successfully with clayey soil, because the shapes do not have any corners.

The size of a charco dam depends on the following factors:

- 1) A farmer's financial capacity to hire labourers to assist him with excavation.
- 2) The expected volume of run-off water from the catchment.
- 3) The area available for constructing the pond.
- 4) The soil type.

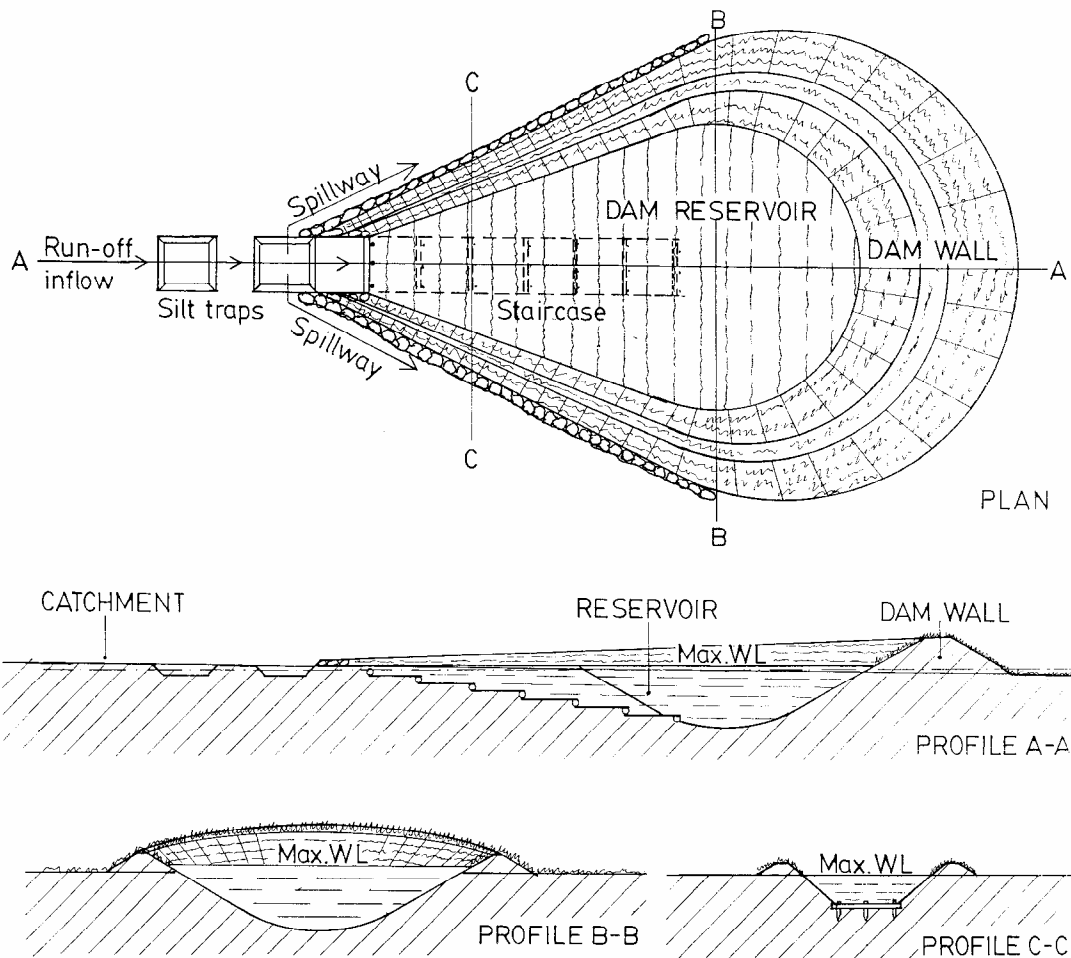

Recommended plan and profiles for a standard design of charco dams.

### 4.3 Marking out a charco dam

Before the excavation work of a charco dam can be started, the outline of the various parts of the structure has to be marked with wooden pegs. A standard lay out of a charco dam is shown below.

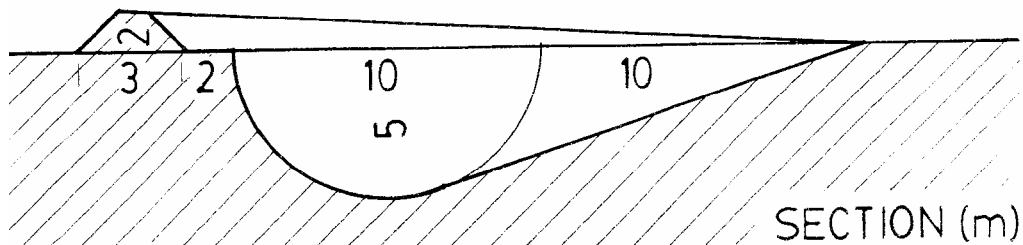
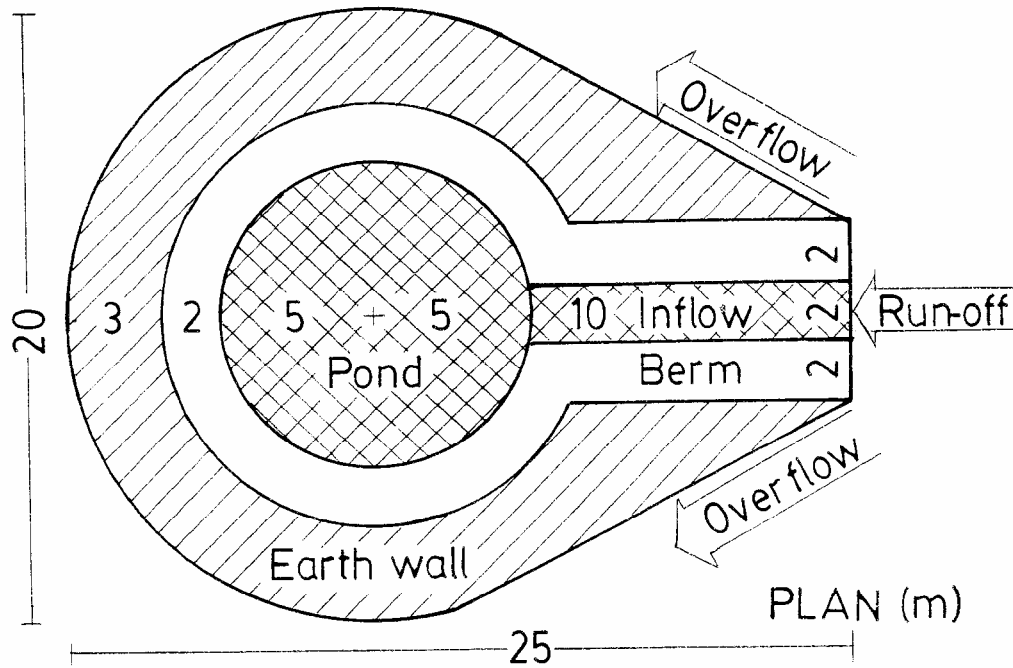

When pegging out a charco dam, always remember that the inflow must be situated where rainwater run-off either accumulates in a shallow pan, or passes by as a small stream during rains. The volume of rainwater running into a dam can be increased by either extending the catchment area or diverting a small stream by means of a soil bund stretching upwards with a gradient of 3 cm per 100 cm from the inflow.

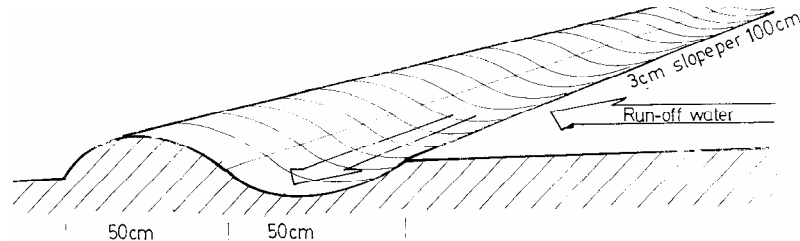

A soil bund that slopes upwards from the inflow of a dam will increase the volume of rainwater flowing into the dam.

#### **4.4 Construction**

The construction site should be cleared of all vegetation, including the semi-circular area where the excavated soil will be placed as the dam wall on the lowest side of the water reservoir.

Then the outlines of the dam reservoir and the half-circular dam wall are drawn and pegged out using a long string tied to the centre of the dam reservoir. A two metre wide space, called a berm, should be left untouched between the dam reservoir and the dam wall. Its purpose is to facilitate transportation of soil, while also preventing soil from the dam wall to slide back into the excavated reservoir. The excavated soil should form a semi-circular dam wall (embankment) all around the water reservoir, except at the inflow channel, to reduce wind speed and evaporation. The slopes of the dam wall should be flatter than 1:1 (45 degrees). The top of the dam wall, called the crest, must be highest opposite the inflow channel to prevent wash-out of the dam wall.

Rainwater must not be allowed to wash any soil back into the pond. Therefore, trees and grass should be planted on the dam wall to protect it from erosion and create a windbreak. More trees should be planted outside the embankment on the side towards the prevailing wind to form a windbreak, which will reduce evaporation losses and provide firewood, poles and timber.

Another way to reduce evaporation and conserve water towards the end of the dry season is to deepen one end of the dam reservoir. As the pond dries out, the remaining water will accumulate in the deeper section and minimise the area of water exposed to evaporation.

A spillway should be built at each end of the curved dam wall that reaches the inflow channel. These two spillways will facilitate excess water to spill over the water reservoir safely. Large stones should be placed along the lower side of the two spillways to prevent erosion of the dam wall.

A series of silt traps also need to be constructed to reduce the volume of sediment entering the dam reservoir. These can be made by excavating depressions in the flat land before the inflow channel. Sediment trapped in the silt traps should be removed after rain showers, so the silt traps do not get filled up with silt. The removed silt is rich in nutrient and therefore an excellent fertiliser for a vegetable garden.

#### **4.5 Constraints**

There are a few constraints to the increased adoption of charco dams, such as:

- 1) Lack of technical knowledge for design, construction and maintenance - until this handbook is published.
- 2) The volume of the water reservoirs is reduced if silt is not removed from the silt traps after rain showers.
- 3) Seepage losses where dams in sandy soils have not been lined.
- 4) Evaporation losses where dams have insufficient wind breaks.

## Chapter 5. Hillside dams

Small earth dams with curved walls built on hillsides and sloping land are the simplest and cheapest earth dams to locate, design, construct and maintain. It is therefore surprising that these dams, known as *hillside dams*, are not promoted more widely.

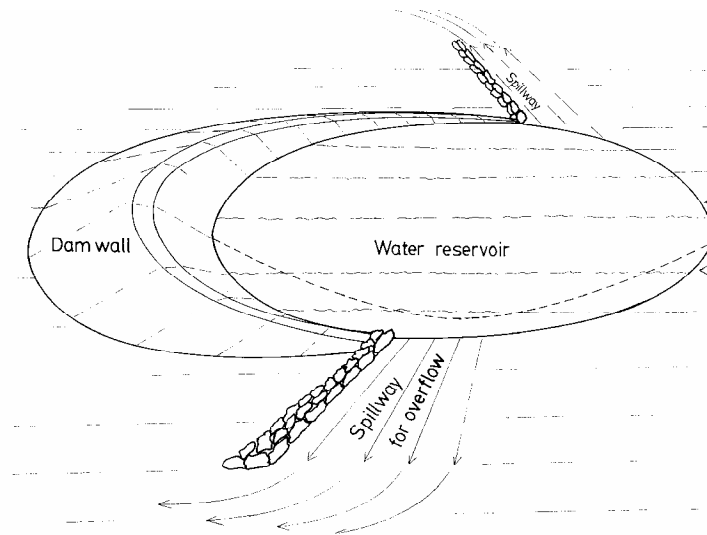

A bird's-eye view of a hillside dam.

### 5.1 Site selection

Suitable sites for hillside dams can be found on almost any sloping land that produces rainwater runoff. The catchment can include roads, compounds, roofs, agricultural land and rock outcrops. To avoid contamination of the water, there should not be any pollution sources, such as drainage from villages, slaughter houses, latrines, rubbish pits, cattle dips etc., in the catchment area.

Naturally, the best soil type for constructing a water reservoir should have a high content of clay. However, soil types other than the clayey type can also be used, although some seepage may occur downstream. For more details on soil types, please see Chapter 7.

Despite seepage being considered as wasted water, the water can still be utilised constructively if it was extracted from a hand-dug well, thereby providing safe and clean water for e.g. domestic use, watering livestock, garden irrigation, making burnt bricks, a wood lot, etc.

### 5.2 Design

The design of hillside dams consists of a semi-circular dam wall, shaped like a new moon. The curved dam wall is made of compacted earth, which must be higher at the middle than at both ends to prevent any water spilling over the middle of the dam wall.

Each of the two ends of the curved dam wall function as spillways and should therefore be at the same level. The lower sides of the two spillways are strengthened with rocks to prevent the water from spilling over and eroding the ends of the dam wall.

## Simple equipment for measuring levels and gradients

A levelling instrument, called a dumpy level, is expensive to buy and difficult to borrow. A much simpler levelling instrument can be made from a one metre long length of transparent hosepipe that is bent into a circle and filled halfway with water.

When sighting along the two water levels in the hosepipe an exact horizontal line is projected forward.

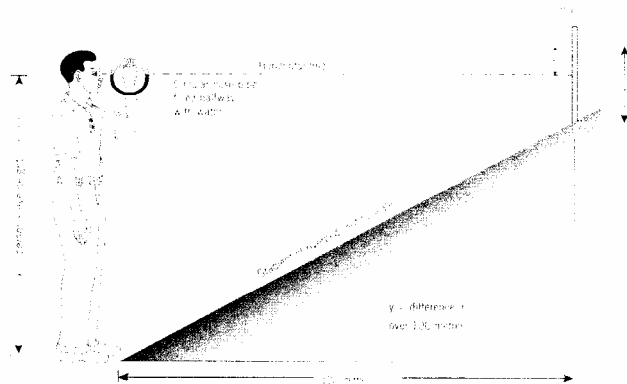
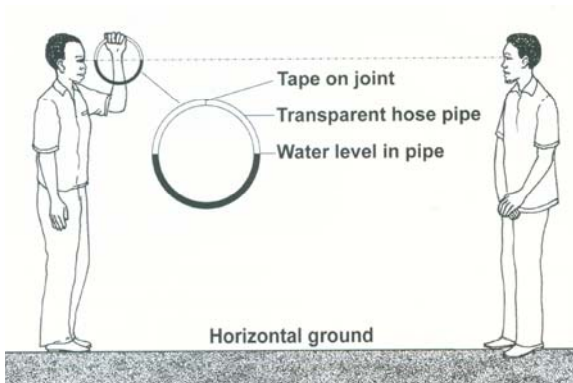

Horizontal contour lines are found by two persons having the same eye height. The person who is sighting, tells the other move up or down until his eye is at the same level.

Source: *Water from Dry Riverbeds and Water Surveys and Designs* of this series.

Gradients are found by sighting onto a stick with measurements and measuring the distance between the stick and the person.

A simple tool made of 3 sticks can be used for measuring out levels, gradients and distances. A mark is made at the exact middle of the horizontal stick and a small stone is tied with a string to the top of the other two sticks. To measure a horizontal line, the two legs must have exactly the same length and the string with the stone must be perfectly aligned with the mark. The tool seen to the left is made in such a way that it will measure a gradient of 3:100 for the floor of spillways.

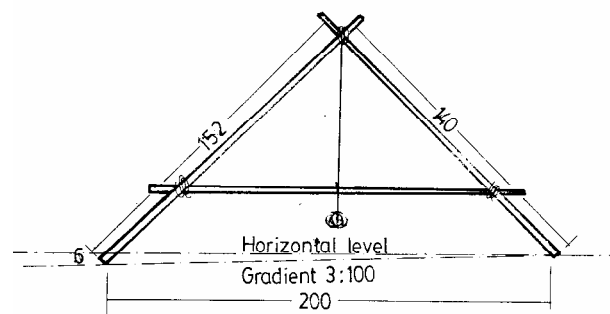

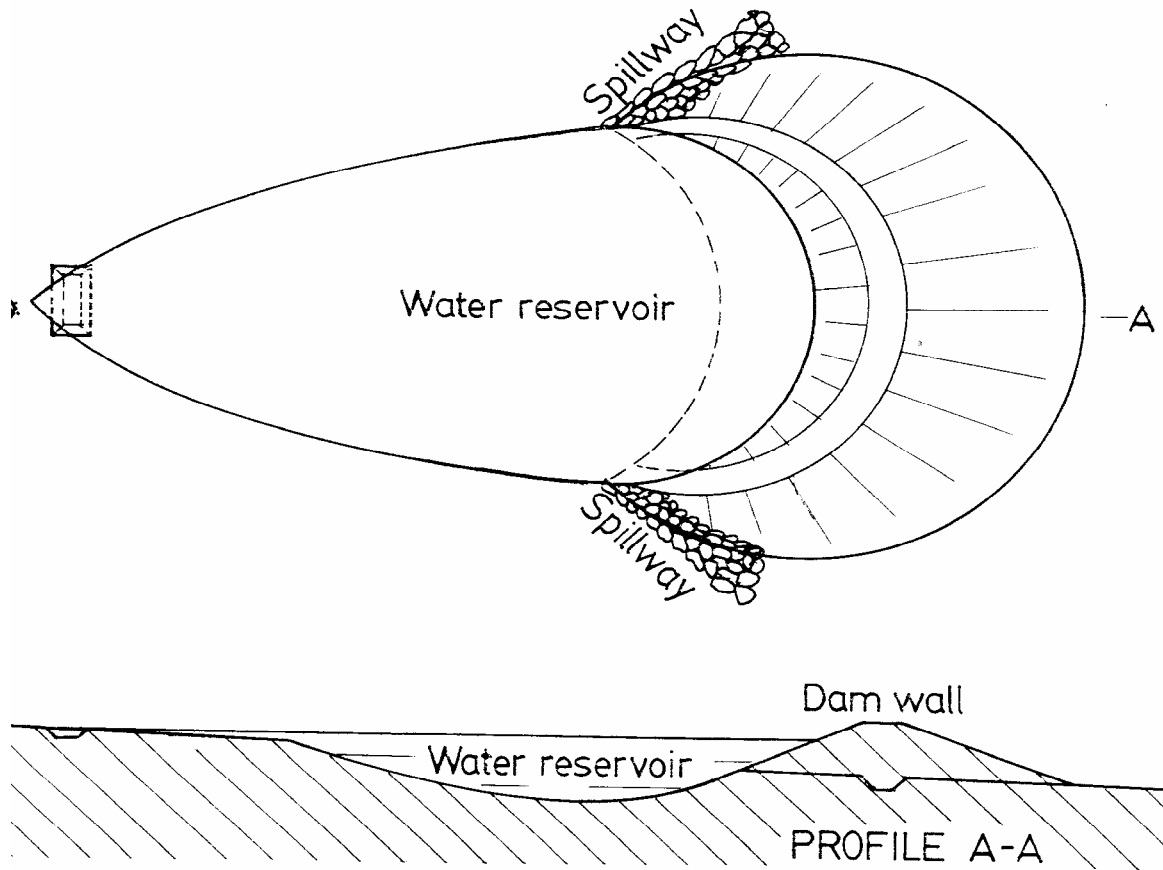

Plan and profile of a hillside dam.

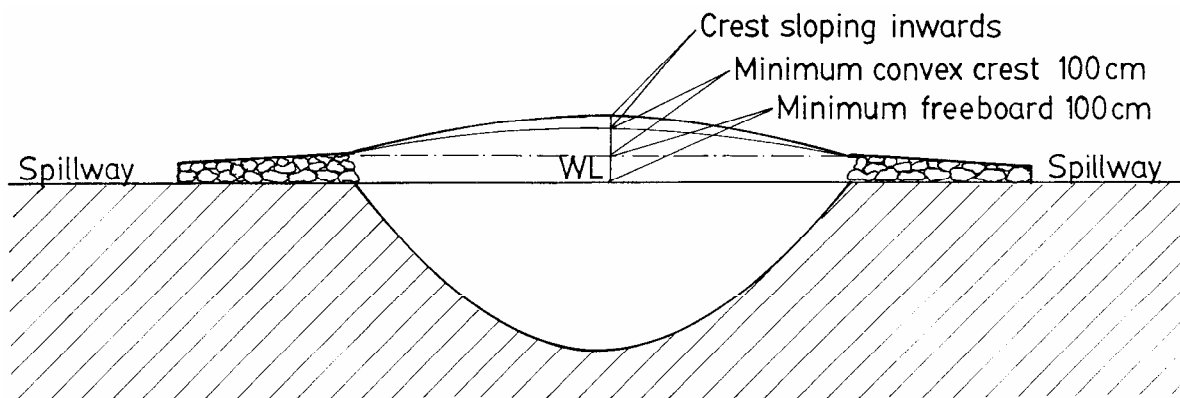

This cross profile of a hillside dam shows that the dam wall should be at least 100 cm higher in the middle than the two ends that function as spillways. The two ends of the dam wall must be at least 100 cm higher than the level of the spillways.

It is not essential to know the runoff volume of rainwater from the catchment for hillside dams, because when the reservoir is filled with water, surplus water will simply spill over the ends of the dam wall, which are the spillways, and continue its downhill course.



Another very positive feature of hillside dams is that it is possible to start by constructing a relatively small dam for storing water from the first rainy season, and then enlarging it during the following dry seasons. This can be done a number of times until the reservoir has been significantly enlarged to the desired capacity as shown below.

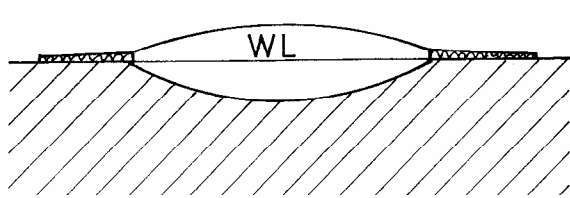

During the first dry season, it is possible to excavate a shallow water reservoir and use the excavated soil to build a low dam wall.

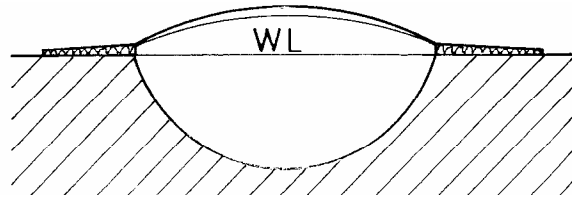

Result after deepening the water reservoir and heightening the dam wall with excavated soil from several dry seasons.

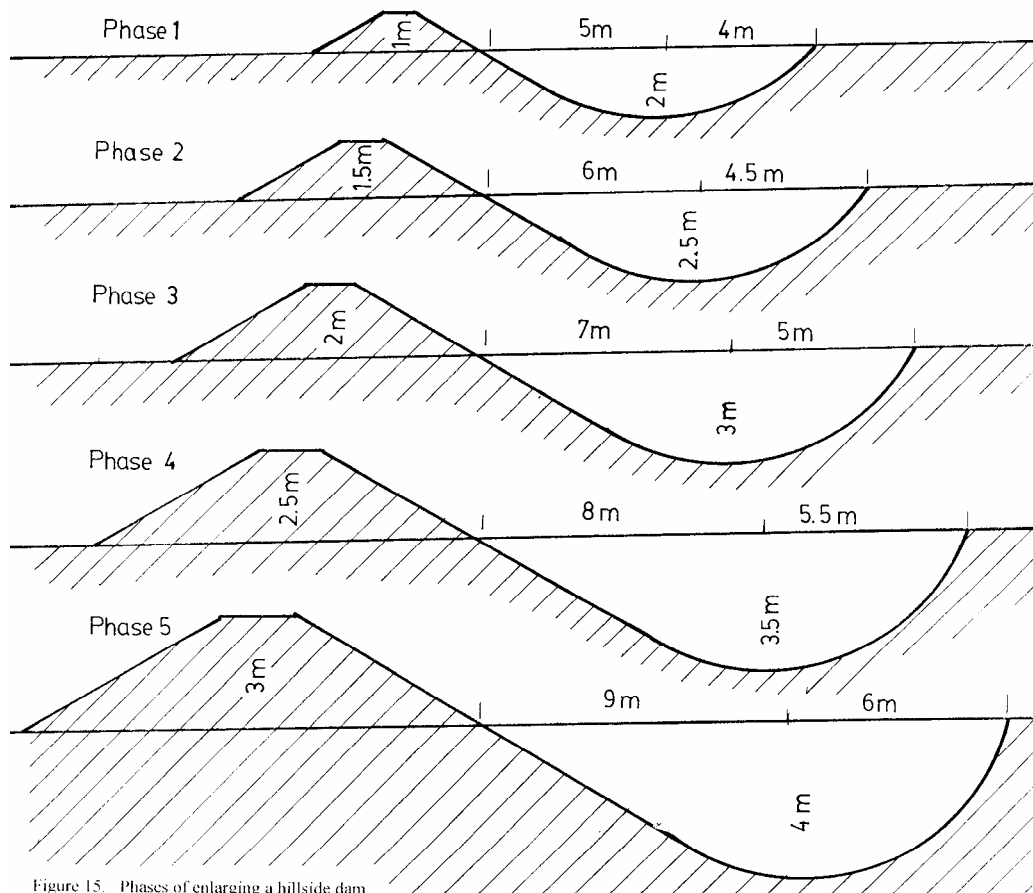
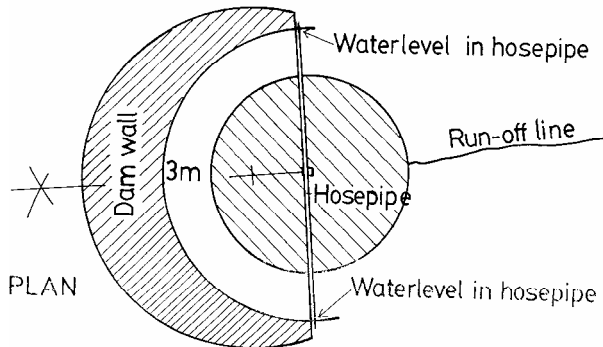

Figure 15. Phases of enlarging a hillside dam

The enlargement process of hillside dams can also be illustrated as above.  
Source: Water from ponds, pans and dams by Erik Nissen-Petersen, RELMA/Sida 2004.

### 5.3 Construction

**Pegging out** the outline of a hillside dam is done by hammering a peg into the run-off line of the rainwater. Preferably, the peg should be placed in a depression in the run-off line, because that will provide free storage capacity.



A plan and a photo of a hillside dam that is placed correctly across a run-off line of rainwater. The two ends of the dam wall must be horizontal to function as spillways. A horizontal line can be found by either a transparent hosepipe filled with water or a circular transparent hosepipe filled halfway with water. Please, see Chapter 8 for details.

#### Excavation work

The excavation and soil works for a small earth dam on a hillside site can be done manually, with oxen, a plough mounted on a farm tractor, or a crawler. The construction work involves excavating soil from the central pit and placing it in a semi-circular line along the downstream side of the excavation as shown below.



The curved heap of soil will become the dam wall, while the excavated pit will be the water reservoir. The size of the dam wall and its reservoir depends on the capacity for removing soil from the reservoir and placing it on the dam wall. The gradient (slope) of the sides of the dam wall should be 2:1, which is 2m of width for every 1m of height.

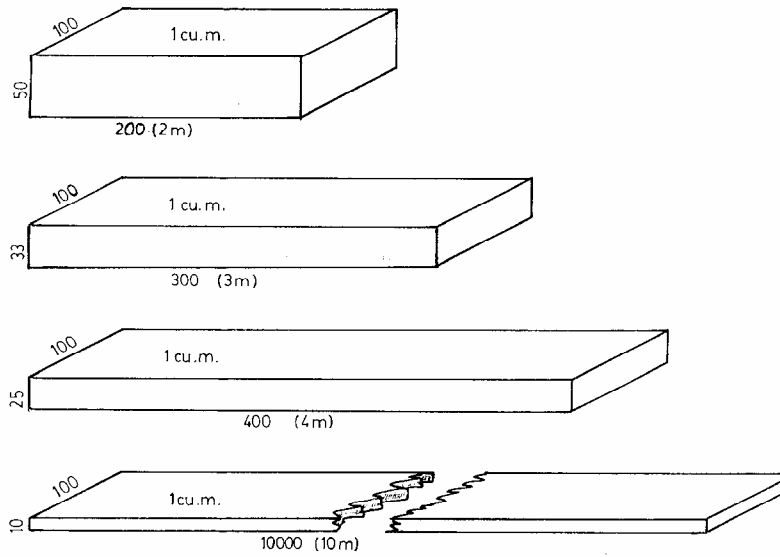

For manual excavation, divide the area to be excavated into “plots”, each plot being exactly 1 cubic metre as shown above. Each plot is numbered and given to an “owner”.



Plots are being marked out with wooden pegs.



Excavation work is halfway completed

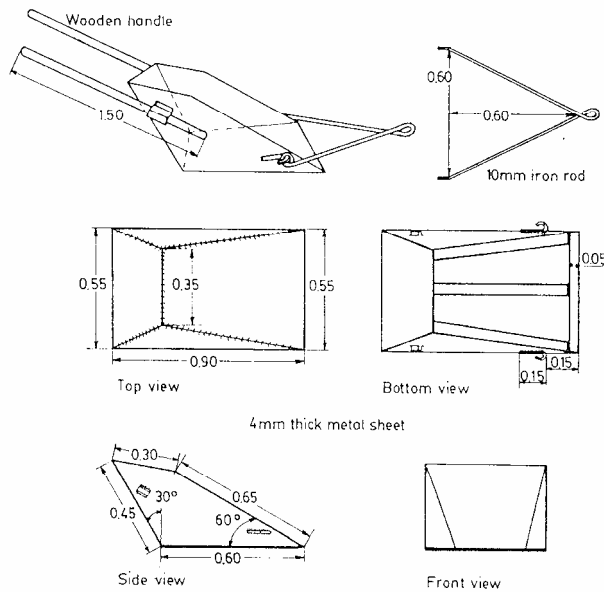

An ox-scoop with two men and oxen can excavate and move more soil than 12 men.

**The crest** (top of dam wall) must always be at least one metre higher at the middle than at the ends to prevent a wash-out of the middle section by a heavy thunderstorm.

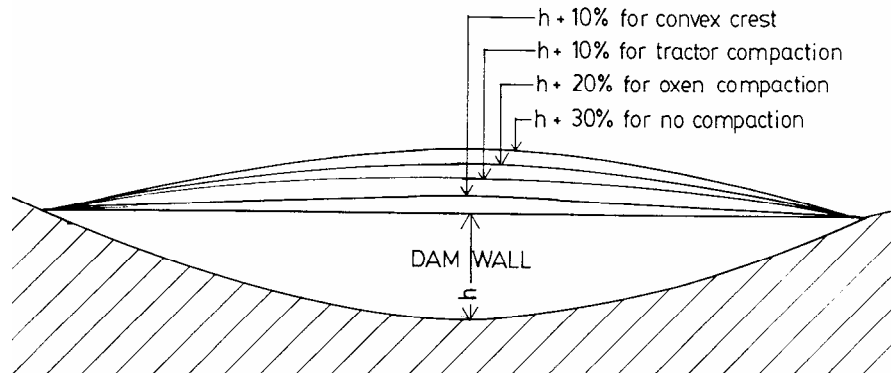

In addition, height must be increased by 10% if the soil is compacted by a tractor. This must be increased by 20% if compacted by oxen and by 30% if the dam wall is not compacted at all. These increased heights are called the settlement allowance, because when the reservoir of a newly built dam gets filled with water, the soil in the dam wall will settle and lower the middle of the dam wall, which endangers the safety of the dam.

### **Spillways**

The two ends of the curved wall of hillside dams function as spillways to allow surplus water from the reservoir to flow safely out of the dam. Heavy rain-showers on large catchments produce huge volumes of run-off water that must pass over the spillways without eroding the ends of the dam wall otherwise water might destroy the whole dam wall.

Spillways should therefore be reinforced by placing large stones against the ends of the dam walls. Long-rooted grass with runners should be planted between the stones to prevent overflowing water from eroding the stones. The floor of the spillways should also be covered with stones interplanted with grass to prevent erosion. If the floor of the spillways is steep a concreted stone-masonry structure may be needed.

### **Enlarging a catchment**

Should the volume of run-off water not be sufficient to fill a pond, then a catchment can be enlarged by diverting run-off water from another catchment into the pond by means of soil bunds as explained in the former chapter.

### **Enlarging a water reservoir**

Dams having catchments with sufficient run-off can be enlarged to hold much more water by deepening the reservoir and using the excavated soil to increase the height of the dam wall. Labour for enlargement of dams might be obtained by:

- Allowing neighbours to collect water free of charge, if they will excavate and transport one wheelbarrow of soil for every one jerrycan of water they fetch.
- Charging people a fixed amount for every jerrycan of water they fetch and using the money raised to hire people for further excavation work.



A hillside dam built by a tractor ploughing in circles against the dam wall in Zambia. It took the farmer two weeks to complete the construction works.



A hillside dam built manually at the foot of a rock outcrop in Kitui, Kenya, some 40 years ago. The dam is still providing clean water for domestic use from a hand-dug well sunk into a seepage line downstream of the dam wall.



An example of a hillside dam harvesting rainwater run off the Machakos-Kitui road.

## **Chapter 6. Valley dams**

An earth dams built in a valley is the cheapest way to create a water storage, because the excavation work is less than for Charco dams and hillside dams. However, the gain in cost per volume can be lost overnight by flooding from one heavy thunderstorm or shower, which, unfortunately seem to be bigger every year. The wash-out of a dam wall can be very serious and endanger both lives and property. For this reason experienced technical help should always be sought for the design and construction of valley dams which might present a possible threat to downstream households.

The series of photos for this chapter on valley dams were taken during a training course on manual construction of valley dams. A team of 25 engineers and technicians surveyed, designed and supervised the construction of *Kimuu* dam at Kibwezi in 1998. In spite of all precautions taken and all design criteria being followed, the dam was washed away after 72 hours of a continuous and heavy downpour. The rains were so exceptionally heavy that a nearby valley dam, *Kamuti*, which was built in 1956 and had survived El Nino, was also washed away that night.

The lesson of these two disasters is that the width of spillways and the height of freeboards should no longer be calculated on the basis of the maximum rainfall per hour for the last 50 years. A bigger safety margin, of say 25%, has to be added.

### **6.1 Legal requirements**

As mentioned earlier, there are more legal requirements for valley dams than for charco and hillside dams. The reason being that valleys often have seasonal, or even perennial streams of water on which people living downstream depend for their livelihood. A permit for building a dam and extraction of water is therefore required from the local authorities, such as a District Water Bailiff.

Another requirement is a professional design with BQ and cost, and an environmental assessment report might have to be produced and approved by the local authorities.

A third legal aspect is that the floors of valleys are often boundaries between different landowners. Their permission and cooperation is required for, among other things, the dam construction, the usage of the water, and the protection of the catchment area. This can be a time-consuming task if the landowners live far away, or are perhaps never seen.

Nevertheless, if the construction of a valley dam is still desirable, the next issue is to evaluate the financial viability in order to avoid potential losses.

### **6.2 Financial viability**

It is always worthwhile to make a rough estimate of whether it is economically viable to construct a dam, before spending a lot of time and money for labour on it. The first criteria should therefore be whether a dam can supply sufficient water to pay back the investment over some 10 years.

The rainwater runoff from the catchment area must therefore be sufficient to fill the proposed water reservoir during a rainy season. On the other hand, if the catchment is too large, the volume of run-off water might be so voluminous that the dam risks being washed away, even if spillways are extra large.

Since it is very difficult to obtain precise rainfall data, a simple and reliable method on estimating the volume of run-off can be applied as shown below.

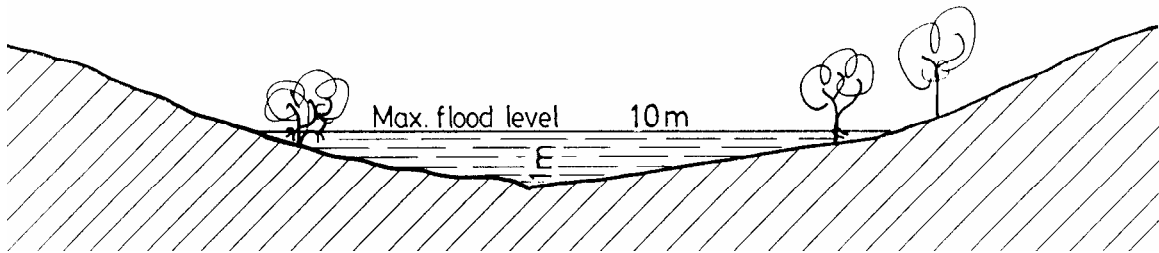

Long-time residents' knowledge about the biggest flood ever experienced can be used as the basis for calculating the size of spillways, as follows: Multiply the width of the flood with its depth and divide by 2. In this example:  $10 \times 1 \text{ m} / 2 = 5$  square metres of flood. If the flood moves with a velocity of 1 metre per second, and if the valley is flooded for an average of 3 hours, the volume of rainwater run-off will be:

**5 sq.m. x 1 m x 60 seconds x 60 minutes x 3 hours = 9,000 cubic metres of water.**

Now the question is: What are the approximate dimensions of a water reservoir for a valley dam that should be able to store 9,000 cubic metres of water?

The question can be answered by the formula for estimating the volume of a reservoir for a valley dam, which is:

**Maximum width x maximum depth x maximum throw-back (length) / 6 = Volume.**

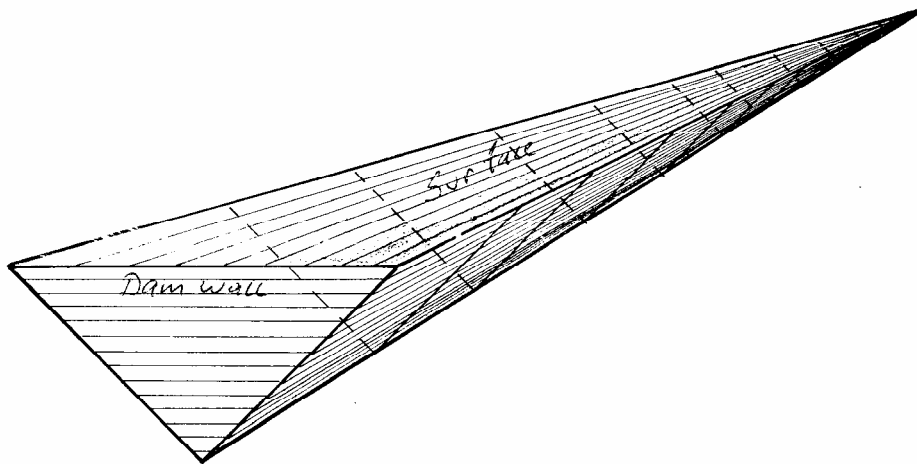

For example:  $50 \text{ m max. width} \times 5 \text{ m max. depth} \times 220 \text{ m max length} / 6 = 9,167$  cubic metres storage volume, which can store the required 9,000 cu.m. run-off.

The next question is: How much soil work will it take to construct a dam wall capable of storing the 9,000 cu.m. water? A rule of thumb states the following:

Since the dam wall has to be about 2 metres higher than the water level, it will have a maximum height of 7 m. The maximum width of its base, with a batter gradient of 2.5:1, will be 7 m x 2.5 x 2 sides = 35 m, plus 2 m crest = 37 m width at the highest part.

The soil work will therefore be approximately:

7 m height x 37 m width x 50 m length / 4 = 3,238 cubic metres of soil, which is to be excavated from the two spillways, situated at either each end of the dam wall.

The cost of excavating, transporting and compacting 3,238 cu.m. of soil depends on whether it will be carried out by manual labour, animal draft, a farm tractor with a scoop or a crawler. Naturally, the cost of these means of soil works varies locally and country-wise. Nevertheless, the following estimates can be used as guidelines.

Method of soil works	Ksh
Animal draught of 3,238 cu.m. of soil @ Ksh 60/cu.m =	194,280
Manual labour of 3,238 cu.m. of soil @ Ksh 75/cu.m. =	242,850
Farm tractor of 3,238 cu.m. of soil @ Ksh 100/cu.m =	323,800
Crawler of 3,238 cu.m. of soil @ Ksh 200/cu.m =	647,600

If the legal aspects and the economical estimate seem reasonable, then look for a viable site that can fulfil the following site criteria:

### 6.3 Site criteria

- 1) The wall of the earth dam should be situated in a narrow part of the valley that widens just upstream to give additional free storage capacity for water.
- 2) The dam wall needs to be built in a part of the valley which provides an impervious (water tight) valley floor of clayey soil.
- 3) The valley floor should be flat, because it will give free storage volume.
- 4) The dam wall should be situated at least 100 m from any bends in the valley to prevent currents causing erosion when heavy runoff occurs.
- 5) Suitable clayey soils for building the dam wall should be available from a borrow pit in the reservoir and from excavating the spillways.
- 6) Reservoirs should not contain boulders or rock outcrops because they might cause leakages; this can be prevented if covered with clayey soil.
- 7) Natural depressions in the banks of a reservoir, when present, should be used for spillways in order to reduce construction costs.



## 6.4 Measurements to be taken of a dam site

When a suitable site has been found, the following measurements are required to draw a design and calculate the Bill of Quantities (BQ) and estimate construction costs:

### 1) Bench Mark (BM)

Make a bench mark (BM) on a tree or rock, or concrete a few stones together near one end of the proposed dam wall. Mark the BM point with white paint to make it visible from a distance. Plot the position of the bench mark onto a contour map of 1:50,000 if available, otherwise draw a sketch on graph millimetre paper to a scale of 1 centimetre being equal to 2 metres.

From now, all measurements, levels and heights will be taken from this BM and drawn in the sketch.

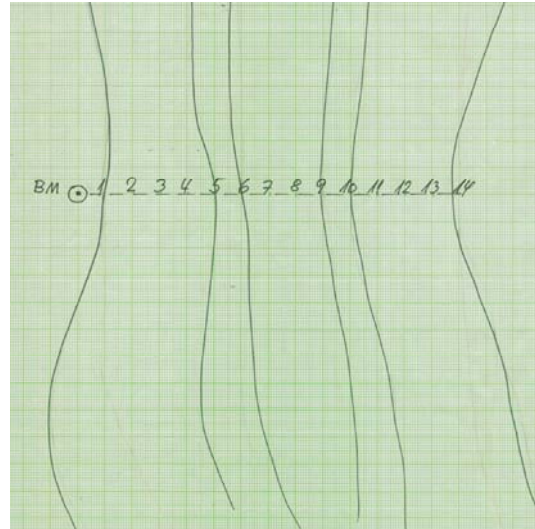

Plan of a dam site with a BM on the left side from where all measurements, levels and heights are taken.

### 2) Maximum water level (WL)

Draw a builder's line and a long tape measure across the valley from the BM to the opposite end of the dam wall as shown in the photo.

Insert the ring at the end of another long tape measure onto the builder's line in such a way that the tape measure can slide across the valley.

Then take the vertical measurements from the builder's line to the floor of the valley for every 2 metres, which is read on the tape measure hanging on the builder's line.

Also measure the length and depth of the maximum flood that has ever passed through the valley. This data shall be used for estimating the width and depth of the spillways.



The photo shows a builder's line and a long tape measure being drawn over a narrow point in the valley

## 6.5 Design

The measurements taken from the builder's line can be recorded as:

Measurement no.	1	2	3	4	5	6	7	8	9	10	11	12	13	14
Horizontal m	2	2	2	2	2	2	2	2	2	2	2	2	2	2
Vertical m	0	2	3	5	6	6	5	4	5	5	4	3	2	0
Max. flood level	0	0	0	1	2	2	1	0	1	1	0	0	0	0

These measurements were converted into a profile of the riverbed as shown below.

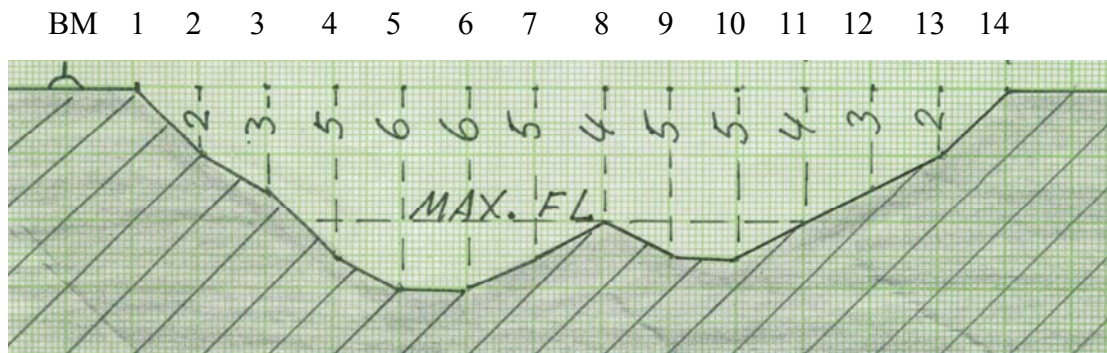

A profile drawn according to the measurements taken from the builder's line drawn across a narrow part of the valley where the dam wall will be constructed.

### Spillways

The maximum flood level (MAX. FL) is 15 m wide and 2 m at its deepest. That gives a cross section of:  $15 \text{ m} \times 2 \text{ m} / 2 = 15$  square metres. The size of the spillways should be the double of that, namely 30 m wide and 1 m deep = 30 square metres.

The maximum water level, and the depth and width of the spillways can now be drawn on the profile as seen below.

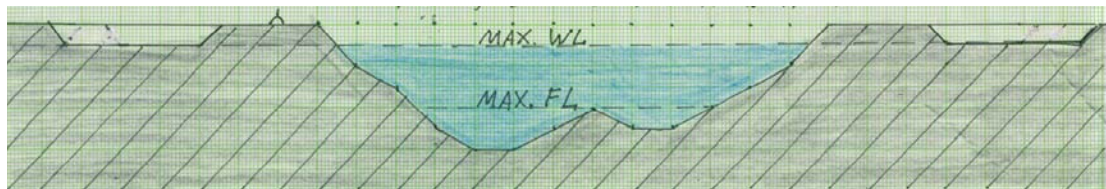

The sketch shows the maximum water level (MAX. WL), which is 1 m below the ground level, and the two spillways having a width of 30 m and depth of 1 m, equal to 30 square metres, below the ground level.

### Freeboard

The next sketch shows the 1.5 m high freeboard, which ensures that floodwater rising above the MAX. WL will spill over into the spillways without damaging the dam wall. The sketch also shows the crest (top of the dam wall) that must be higher in the middle than at its ends to cater for settling (sinking) of a new dam wall.

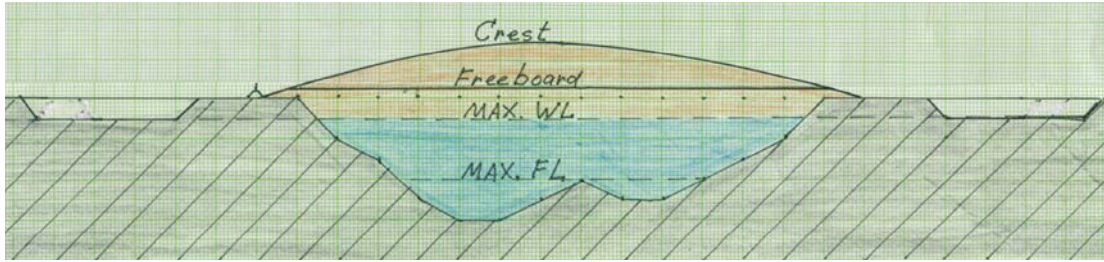

The sketch shows that a freeboard 1.5 m high has been added to the MAX WL, and that the dam wall has been raised above the freeboard with a convex (upward) crest to cater for settling of the soil in a new dam wall.

### **Convex crest**

The settling of soil in a new dam wall depends mainly on the method of compacting the soil when building the dam wall. Therefore the crest of an earth dam should always be highest at the middle and lowest at the ends (convex). This is to avoid a washout of the middle section of the dam wall in case the spillway is blocked, or cannot cope with the peak discharge in a heavy storm. Should a washout happen, it is easier to repair the end of a dam wall instead of repairing the deep middle section.

Soil used for building dams is excavated and transported to the site by baskets, wheelbarrows, ox-carts, donkey carts or tractor trailers, and off-loaded on the dam wall. During the process, soil is broken into small pieces with voids filled by air.

No matter whether the soil is compacted manually or by animals, tractors or even crawlers, the height of a newly built dam wall will settle when the reservoir is filled with water for the first time. This settling occurs because the soil, made pliable and heavy by water, will press air out of the voids in the soil.

Many new earth dams have been washed away by floods over-topping their crests which had become too low (concave) at their middle due to soil having settled more than expected. Dam walls must therefore always be made higher (convex) at their middle section.

The height of a convex crest above the freeboard depends on the height of the dam wall measured from the floor of the valley to the freeboard as follows:

- 10 % of the height of the dam wall when compacted dry by machinery.
- 20 % of the height of the dam wall when compacted dry by people and livestock.
- 30 % of the height of the dam wall when not compacted at all.

The width of the crest of a dam wall should be sufficient to allow traffic to use the crest as a road spanning across a valley. The minimum width of a crest should be 2 m for walking and 3 m for vehicles, if they want to pass over the dam wall.

### Key under dam walls

To prevent seepage passing under dam walls, it is necessary to build a key, also called a cut-off trench, or a core trench. The key consists of a trench dug immediately below the centre line or crest of the dam wall. The key must extend along the dam wall and include all sections that lie below the maximum water level.

The key must be excavated down through all layers of sand and gravel until it is at least 0.6 metres into watertight soil, like clay and murrum. The width of a key should be at least 2.5 metres with its sides sloping at 45 degrees. A key is back-filled and compacted with the most clayey soil found on or near the construction site.

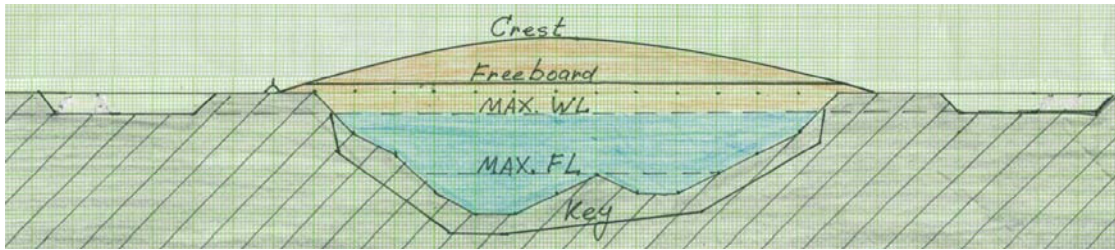

A sketch showing the key under a dam wall.

### 6.6 Soil for dam walls

Before the cross section of a dam wall can be drawn, it is necessary to analyse some soil samples taken on the site, because the type of soil available on the site determines the type of the dam wall to be constructed. Soil can be classified as follows:

Well graded gravel	=	GW	Inorganic silt with low liquid	=	ML
Poorly graded gravel	=	CL	Inorganic clays with low liquid	=	CL
Silty gravel	=	GM	Organic silts with low liquid	=	OL
Clayey gravel	=	GC	Inorganic silt with high liquid	=	MH
Well graded sand	=	SW	Inorganic clay with high liquid	=	CH
Poorly graded sand	=	SP	Organic clay with high liquid	=	OH
Silty sands	=	SM	Peat and highly organic soils	=	Pt
Clayey sand	=	SC			

Source: Nelson, K.D. 1985

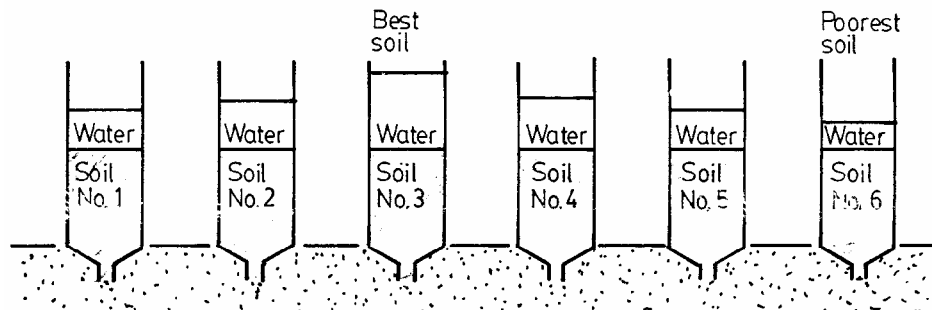

A simpler method is to remove the cap and bottom of some transparent plastic bottles. Place the bottles upside down in sand or between stones. Fill the bottles halfway with soil samples and top up with water. The soil with the slowest seepage is the best for building dam walls, because it has the highest clay content.

**Homogeneous dam walls** can be built of the soil types classified as GC, SC, CL and CH, and if the soil has a clay content of 20% to 30%. (See Chapter 7 for soil analysis).

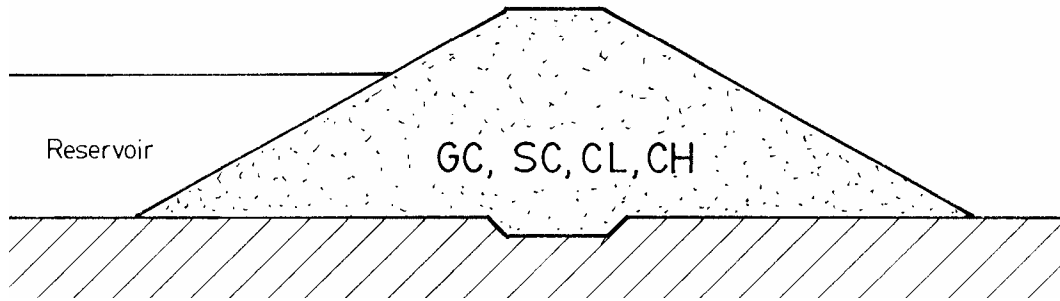

A homogeneous dam wall built of one type of soil. The letters refer to the soil types listed above.

**Zoned dam walls** consist of a core of clayey soil whose sides are supported with sandy soil. It is a more stable and economic design than a homogenous dam wall because it can be built with steeper slopes, thereby reducing the cost of earth works.

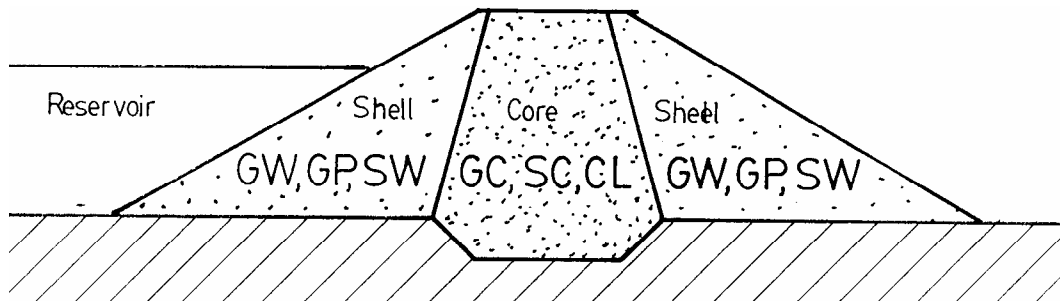

A zoned dam wall with a core of clayey soil supported by sandy soil.

**Diaphragm dam walls** are used where there are plenty of rocks and/or stones or gravel on a site. These pervious materials are covered on the upstream side with an impervious blanket (diaphragm) of soil with a clay content of 12% to 40%. The blanket must start below the front toe to prevent seepage under the dam wall.

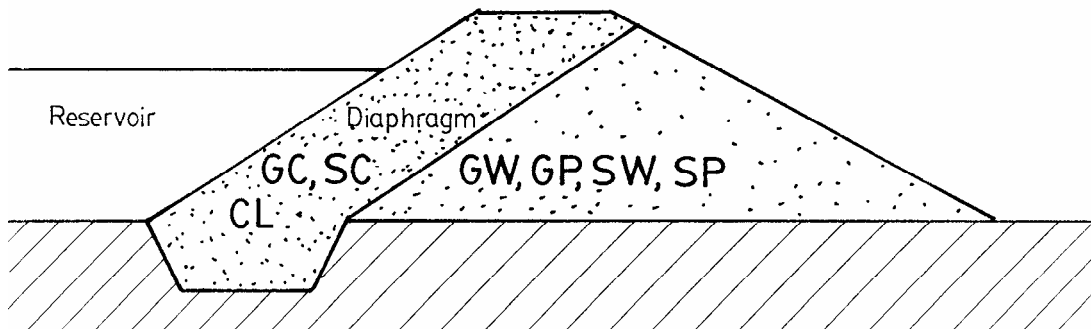

A diaphragm dam wall with a blanket of clay soil covering pervious materials.

### 1) Gradients of dam walls

The upstream and downstream gradients (slope) of dam walls depend on the type of soil to be used for the construction works. Unstable sandy soils require more gradient than stable clay soil.

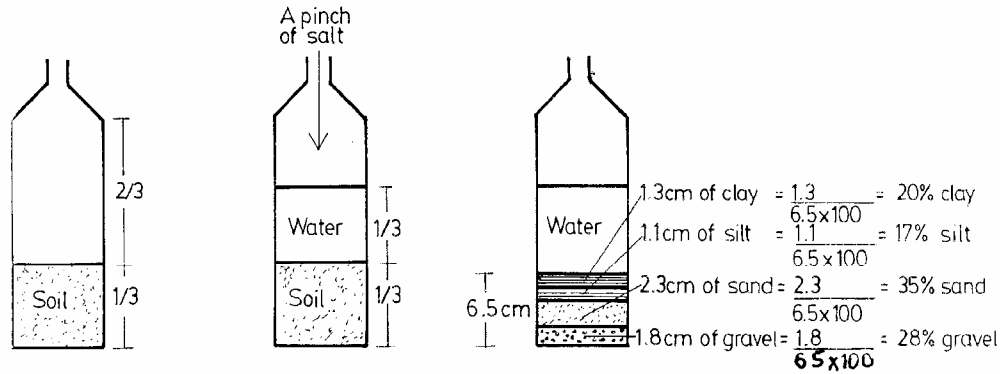

Soil texture can be measured in another simple way. Fill a transparent bottle one-third with a soil sample. Add a pinch of salt. Fill up the bottle with water and shake it vigorously for one minute. Leave it for 1 hour. Then shake it again and leave it for 4 hours to settle completely. Then measure the layers of soil. By dividing the thickness of each layer with the total thickness of the soil and multiplying with 100, the percentage of clay, silt, sand and gravel can be known.

Also high dam walls require more gradient than lower walls due to safety reasons. The table below shows the standard gradients of dam walls. The ratio 2.5:1 means that for every 1 metre height the horizontal length will be 2.5 metres.

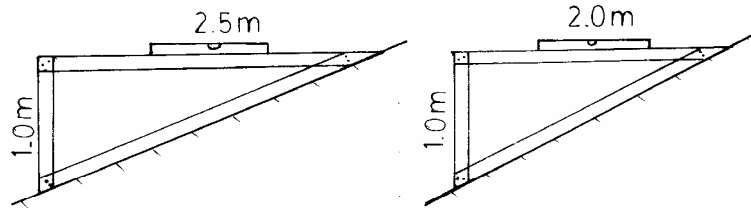

Nail three pieces of timber together and place the triangle on the upstream and downstream side with a spirit level horizontally on it to measure a gradient of 2.5:1 on the left and 2:1 on the right side of the sketch shown above.

	Soil type:-	Clayey gravel (GC)	Clayey sand (SC)
<b>Height of dam</b>	<b>Position</b>		
Below 3 metres	Upstream slope	2.5 : 1	2.5 : 1
	Downstream slope	2 : 1	2 : 1
3 m to 6m	Upstream slope	2.5 : 1	2.5 : 1
	Downstream slope	2.5 : 1	2.5 : 1
Above 6 metres	Upstream slope	3 : 1	3 : 1
	Downstream slope	2.5 : 1	3 : 1

Source: Nelson, K.D. 1985.



Sisal strings have been drawn to mark the gradient of a dam wall and sandy soil is being placed against the core of clayey soil on both the upstream and downstream side.

## 6.7 Data for designing valley dams

The table below shows the conditions required for designing a valley dam.

<b><u>Catchment</u></b>		
Area	-	150ha
Mean average rainfall	-	800mm
Coverage	-	Thick scrub
Length	-	2 km
Slope	-	Steep & hilly
Soil type	-	Fair permeability
Max. run-off volume	-	18,900 m <sup>3</sup> in 24 hours
<b><u>Dam wall</u></b>		
Volume of soil	-	3,345 m <sup>3</sup>
Height	-	6.05 m
Length	-	41.60 m
Width of crest	-	3 m
Convex crest	-	10% of height
Upstream batter	-	3:1
Downstream batter	-	2.5:1
<b><u>Spillway</u></b>		
Width	-	10m
Depth	-	1.5m
Floor gradient	-	3:100
Length	-	60m
Excavation volume	-	600m <sup>3</sup>
<b><u>Reservoir</u></b>		
Max. width	-	40 m
Max. depth	-	4.5 m
Throw-back	-	150 m
Soil excavated		
from borrow pit	-	2,745m <sup>3</sup>
Water Storage Volume	-	4,500m <sup>3</sup>

## 6.8 Bill of Quantities (BQ) and costs

In order to work out the cost of survey, design, tools, equipment, materials and labour which make up the overall Bill of Quantities it is first necessary to calculate the amount of material which needs to be excavated. The box shows how this can be calculated.

The formula for estimating the volume of soil works for a dam wall is:-

$$V = 0.216HL (2C + HS)$$

Where:-

V is the volume of soil in cubic metres.

H is the maximum height of the dam wall in metres - before settling = 7.7 m

L is the length of the crest in metres = 41.6 m

C is the width of the crest in metres = 3 m

S is the sum of the upstream and downstream slope = 5.5

(Upstream slope 3:1 + Downstream slope 2.5:1 = 5.5)

Therefore:-

V, the volume of soil needed for the dam wall, can be found as follows:

$$V = 0.216 H L x (2C + HS)$$

$$V = 0.216 x 7.70 x 41.6 x (2C + HS)$$

$$V = 69.19 x (2C + HS)$$

$$V = 69.19 x (2 x 3 + 7.7 x 5.5)$$

$$V = 69.19 x (6 + 42.35)$$

$$V = 69.19 x 48.35 = \underline{3,345 \text{ m}^3}$$

The soil for the dam wall will come from a borrow pit dug in the reservoir and the excavation of the spillway. The quantity from each source can now be worked out as shown below.

Soil to be excavated from a 1m deep, 10 m wide and 60m long spillway

Width x mean Depth x Length

$$10\text{m} x 1\text{m} x 60\text{m} = 600 \text{ m}^3$$

Soil to be excavated from a borrow pit =  $3,345\text{m}^3 - 600\text{m}^3 = 2,745\text{m}^3$



Where manual labour is being paid for, its cost obviously has to be calculated. Even if the labour is being provided voluntarily it is necessary to calculate how many person days are required. It is worth estimating the value of this local contribution so that the significance of this contribution is rightly recognised and shared with the community. The value of community labour in this example, which involves the manual excavation of 3,345m<sup>3</sup> of soil works, is shown below.

Clearing the site and road; 10 persons for 8 days @ Ksh 100	8,000
Survey and test pits; 10 persons for 3 days @ Ksh 100	3,000
Soil works, 3,345 cu.m. @ Ksh 100	334,500
<b>Total value of community labour</b>	<b>345,500</b>

The cost of surveying, designing and supervising the construction of the earth dam is shown in the table below. It should be noted that this figure does not include the cost of any external technical assistance, such as consultancy fees for assistance with survey and design work.

Fee for survey and design (excl. consultant's fee)	20,000
Fee for Construction Supervisor for 30 days @ Ksh 2,000	60,000
Fee for Water Permit	3,900
<b>Total cost of survey, design and supervision</b>	<b>83,900</b>

The table below shows all the tools, equipment and costs needed for constructing a small earth dam using manual labour.

<b>Item</b>	<b>Quantity</b>	<b>Ksh</b>
Compactors, short tree trunks for compacting soil	5	Self-made
Circular level (for measuring level & slopes)	1	100
Iron bar (for loosening large stones)	1	650
Adjustable spanner (for tightening nuts on wheelbarrows)	1	45
Flat files (for sharpening pangas)	2	500
Mattocks with handles (for excavating soil in spillway)	15	7,200
Nylon lines (for marking out dam wall)	4	400
Pangas (large knife for clearing dam site and road of bushes)	4	800
Wooden pegs (for outlining spillway and dam wall)	50	Self-made
Pick-axes with handles (for excavating soil in spillway)	15	5,700
Shovels (for loading soil onto wheelbarrows)	30	5,400
Sledge hammer (for breaking large stones)	1	395
Wheelbarrows (for transporting soil to dam wall)	30	54,000
Tape measures: 1 x 50 m and 1 x 30 m	2	5,000
<b>Total cost of tools and equipment</b>		<b>80,190</b>

**The cost of tools and materials for incorporating draw-off piping is shown below.**

Item	Quantity	Ksh
Pipe wrenches	2 units	924
Masonry tools	1 set	1,576
Galvanised iron pipes, 1" diameter	84 m	15,000
Cement	5 bags	2,500
Watertap, filter, fittings and lockable man-hole	1 unit	7,000
Total cost of tools and materials for draw-off piping		27,000

**Summary of costs**

The costs of all the different aspects involved in building an earth dam, namely survey, design, tools, materials and labour as outlined above in Tables 15, 16, 17 and 18 are summarised below in Table 19. By adding together all of these separate components of the work, the total cost for the earth dam can be calculated.

Item	Costs	Ksh
Cost of survey, design and supervision (excluding consultant)	83,900	
Cost of tools and equipment	80,190	
Cost of tools and materials for draw-off piping	27,000	
Sub-Total for tools and materials	191,090	
Value of free community labour		345,500
<b>Total cost of constructing an earth dam</b>		<b>536,590</b>

## 6.9 An example of a complete design

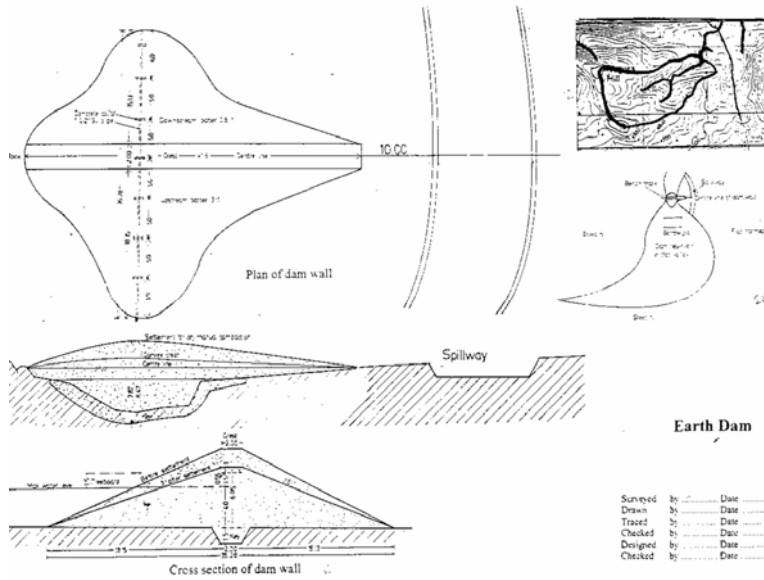

### Catchment area

Area	278 ha
Mean annual rainfall	800 mm
Coverage	Thick bush
Max. length	2 km
Average slope	Steep and hill
Estimated run-off	80,000 cu.m.

### Dam wall

Volume	2,600 cu.m. s
Max. height	6.05 m
Length at crest	41.6 m.
Width of crest	2 m.
Convex curve of crest	10 % of height
Upstream batter	3:1
Downstream batter	2.5:1
Drawn-off pipe	1 1/2" G.I.

### Spillway

Width	20.0 m.
Side slopes	1:1
Gradient on channel	6 %
Upstream length	50 m.
Downstream length	50 m.
Excavation volume	2,000 cu.m.

### Reservoir

Surface area	12,000 sq.m.
Max. depth	4.0 m.
Volume	20,000 cu.m



The Kimuu Valley Dam described in this handbook.

## Chapter 7. Construction of a valley dam

### 7.1 Check list before starting construction work

Before construction work begins it is important to check that the following criteria have been met and relevant procedures followed according to the sequence listed below:

- 1) A suitable site for the dam has been identified and its feasibility investigated in terms of the issues highlighted in Chapter 2.
- 2) A written agreement on the ownership of the dam site, an access road, usage of water from the dam and conservation of the catchment has been completed.
- 3) Design drawings and bill of quantities for the dam are ready.
- 4) A decision regarding the method of excavation of soil works whether manual labour, draught power or machinery. Quotations for purchases and hiring of labour or machinery or prior agreement with community regarding free labour inputs.
- 5) Any legal requirements have been addressed.
- 6) Funds for survey, design and construction of the dam have been secured.
- 7) Construction of valley dams should only be done during dry seasons where there is very little risk of heavy rainfall because a dam under construction can easily be swept away by a thunderstorm or heavy shower.

### 7.2 The key

The key under the dam wall prevents water from seeping through layers of sand or sandy soil under a dam wall. The two ends of a key should extend to the maximum level of water in a reservoir.

Place two pegs at both ends of the lower nylon string to show the width of the key, which should have a width of 2.5 metres. Attach a nylon string between these 4 pegs to mark the full extent of the key.

When a key has been excavated to a depth of 60 cm below any layer of sand or sandy soil, the vertical sides of the key are cut to a slope of 45 degrees for stabilising the excavation.

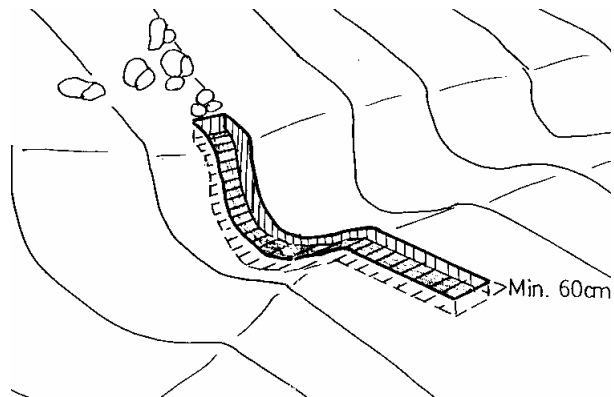

It is a good idea to have an experienced person to inspect an excavated key and to advise on selecting and compacting the best soil for building a water-tight key.

The best soil for a key is clayey soil which can be found using the seepage test in plastic bottles as described in Chapter 6. The soil is filled into an excavated key in layers of 15 cm depth all along the length of the key.

Where water is easily available it can be used to moisten the soil before it is compacted. Where water is scarce, the soil can be compacted without water if all clayey lumps are broken into dust.



The key has been excavated into solid soil with some test pits to prove that there are no layers of sand underneath the key.

The pipe seen on the photo drains a small stream of water through the dam wall. When the dam wall is near completion, the pipe will be closed and the stream will fill the water reservoir.

Preferably, the soil should be compacted in 15 cm thick horizontal layers using a short length of a tree trunk with a handle nailed onto its top as shown to the right.

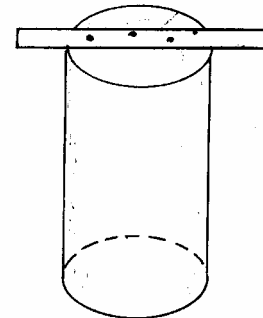

### 7.3 Foundation

Foundations of earth dams, as well as keys, should be made watertight to prevent seepage under the dam walls. This can be achieved by removing all vegetation together with its roots and all patches of sandy soil within the base of dam walls.

The outline of the foundation for a dam wall is determined by the depth from the line showing the maximum water level to the ground and the upstream and downstream slopes of a dam wall (gradients of batters).

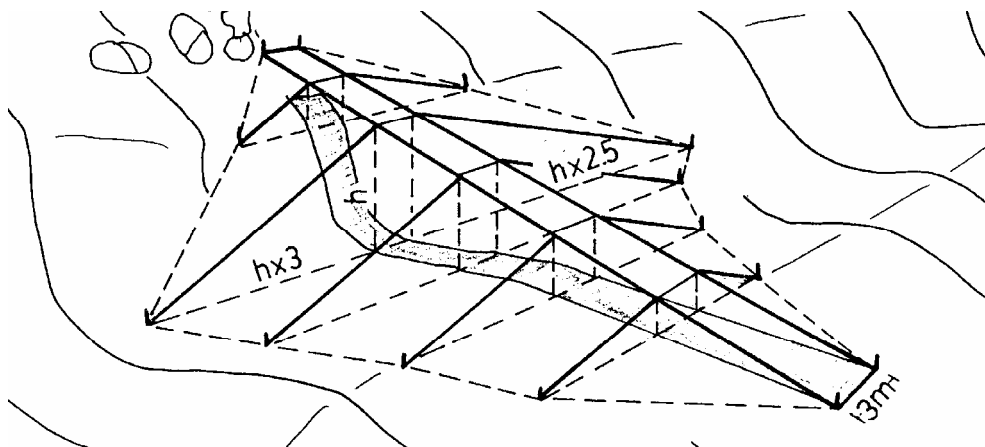

The outline of the base for a dam wall is determined by multiplying the vertical measurements from the maximum water line to the ground with the gradient of the upstream and downstream batter. The upstream measurements are taken from the upstream side of the key and the downstream measurements are taken from the downstream side of the key as shown in the table below.

Point	Depth from centre line to the ground (m)	Gradient of upstream batter 3:1			Upstream length of base from key (m)	Gradient of downstream batter 2.5:1			Downstream length of base from key (m)	
1	1.2	X	3	=	3.6	1.2	X	2.5	=	3.00
2	1.7	X	3	=	5.1	1.7	X	2.5	=	4.25
3	4.0	X	3	=	12.0	4.0	X	2.5	=	10.00
4	5.1	X	3	=	15.3	5.1	X	2.5	=	12.75
5	5.5	X	3	=	16.5	5.5	X	2.5	=	13.75
6	4.8	X	3	=	14.4	4.8	X	2.5	=	12.00
7	4.5	X	3	=	13.5	4.5	X	2.5	=	11.25
8	1.8	X	3	=	5.4	1.8	X	2.5	=	4.50
9	1.1	X	3	=	3.3	1.1	X	2.5	=	2.75

#### 7.4 Draw-off pipe

Where a draw-off pipe is required, it should be laid when the foundation has been excavated. To prevent seepage along the pipe, it is laid in blocks of concrete every 3 metres or so.

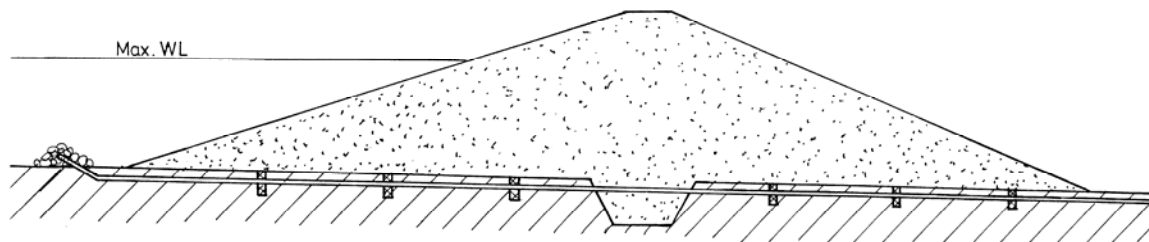

Alternatively, a siphon pipe can be laid over one of the two spillways as shown below.

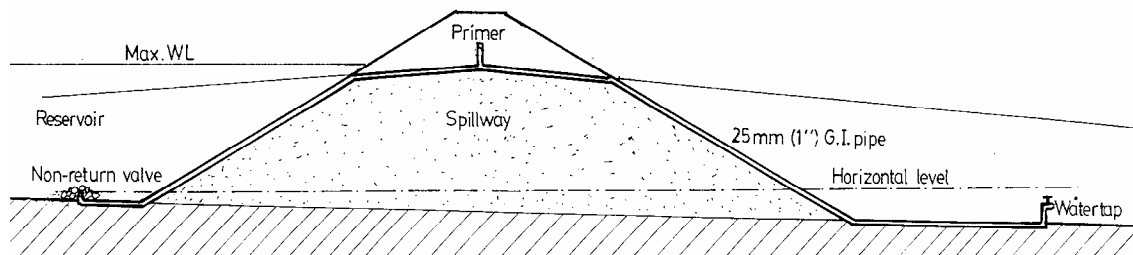

A siphon pipe laid over one of the two spillways. A non-return valve is fitted onto the intake and a watertap onto the outlet. The siphon is started by closing the watertap and filling the primer with water until all air is out. Then close the primer and open the tap.

Water drawn directly from a dam reservoir is not suitable for domestic use, unless the water is boiled, or sterilised by the sun's ultraviolet rays in a transparent bottle (the SODIS method). However, clean water can nearly always be drawn from a hand-dug well sunk into a seepage line somewhere downstream of an earth dam.

## 7.5 Spillways

A spillway should be sited at a distance of at least 10 metres from either end of a dam wall to avoid floodwater eroding the dam wall. The depth of the spillway is measured from the line of maximum water level, which is equal to the lower line of the freeboard.

The floor of a spillway is made level at the centre line. From there the floor should slope 3 cm for every 100 cm towards its upstream and downstream edge. The gradient can be found using a simple tool consisting of a spirit level placed on a 3 metre long timber that has a 9 cm long leg at one of its ends. When the spirit level shows it is horizontal, the leg will be situated 9 cm lower than the other end of the timber, thus marking the required slope of 3 cm per 100 cm. (as 3 cm per 100 cm = 9 cm per 300 cm.)

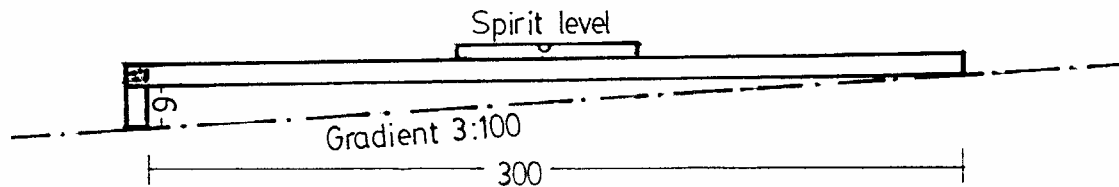

A spirit level placed horizontally on a 300 cm long piece of timber having a 9 cm long leg at one end gives a gradient of 3:100, which is required for the floor of spillways.

Where the floor of the spillway does not consist of weathered rock, then sills (small walls) of stone-masonry should be constructed across the width of the spillway to distribute an even flow of water in the spillway and prevent erosion.

Further protection from erosion can be achieved by building a low wall of large stones set in mortar along the side of the spillway next to the dam wall.

To minimise the risk of a thunderstorm flooding a reservoir and destroying an incomplete dam wall, it is important to excavate a part of the spillway to its final depth before major construction work on the dam wall begins, so that water has an outlet, if needed.

Soil taken from the spillways should be used for the construction of the dam wall. If the volume of soil is insufficient, soil has to be taken from either widening the spillway or from a borrow pit in the reservoir. For safety reasons it is wiser to widen the spillway than to enlarge the borrow pit.



## 7.6 Borrow pit

Analysis of soil samples will show whether a borrow pit in the floor of a reservoir can provide the most clayey soil for making a watertight key and foundation of the dam wall. The excavation of the borrow pit within the reservoir has the advantage of enlarging the reservoir volume and also not leaving any scar on the landscape as the borrow pit will be submerged when the reservoir fills. It is however important that the depth of a borrow pit is never deeper than the bottom of the key, because otherwise water might seep under the key emptying the reservoir. A borrow pit must be at least 10 metres upstream of the front toe of the dam wall to avoid seepage under the wall.

## 7.7 Building the dam wall

To reduce the need to transport soil, the key and the lower part of a dam wall should be built of soil excavated from a borrow pit dug in the floor of the reservoir. The upper part of a dam wall is built of soil excavated from its spillways. When a key has been compacted with clayey soil and the foundation has been cleared of vegetation, roots and sandy soil, the construction of a dam wall can begin as follows:

### The key under a dam wall

The top soil of a borrow pit and spillways is usually the most clayey soil and should therefore be used for building the watertight key under the dam wall.

### The core in the middle of a dam wall

A core is an extension of the key and its purpose is to prevent water seeping through dam walls made of sandy soils. A core is built in layers of about 20 cm thicknesses upon the key and compacted for each layer until the height of the maximum water level is reached without bothering about the final width of the dam wall. This is because it is important to reach the final height of the core before an unexpected thunderstorm may produce a flood that could wash away a dam wall that is too low.



The core of an earth dam is built of clayey soil, while sandy soil is used for the upstream and downstream sides of the dam wall.

Experience has shown that 30% height must be added to the core to compensate for the settling of soil during flooding of the water reservoir.

### The sides of a dam wall

When the core has reached its final height, the sides of the dam wall are built to their final gradients and height. Several nylon strings are drawn from the crest to the outline of the upstream and downstream foundation to show the gradients.

Usually, soil for building the sides is excavated from the borrow pit and off-loaded on the upstream side of the dam wall, while soil excavated from the spillway(s) is off-loaded on the downstream side of the dam wall. This helps reduce the distance soil needs to be moved.



The depth of spillways are measured from nylon strings drawn over the spillways.

The upward curved crest (top of the dam wall) should have its various heights marked out using sticks or poles inserted along the edges of the crest. Soil is thereafter added to the crest until the final correct height and curvature of the convex crest is achieved.

### 7.8 Completing the construction of an earth dam

Upon completion of a dam wall with its convex crest and with an allowance for settling, its sides and crest are made even and smooth using shovels. Trees and bushes in the reservoir are cut down and removed. Holes made by rodents in the floor of the reservoir are filled in with soil and the ground smoothed.

Larger stones should be placed along the side of the spillway that faces the dam wall to protect it from erosion. Smaller stones can be embedded in mortar between the larger stones to form a low stone masonry wall.

Medium-sized stones should be packed on the lower side of the downstream side of the dam wall to form a rock-toe (or backtoe) drain and grass planted between the stones.

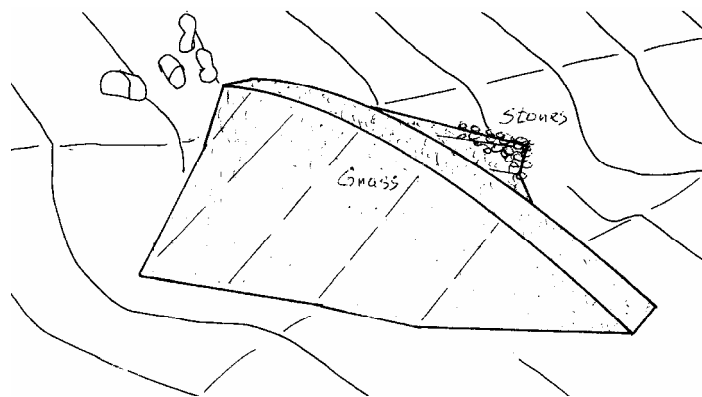

The stone apron will prevent erosion of the dam wall by water and soil seeping out through the back.

Grass with runners is planted on the upstream side of a dam wall, while stones are packed onto the downstream side.

## Chapter 8. Protection of reservoir and catchment area

### 8.1 Reservoir protection

#### Fencing the reservoir

Where feasible, it is often appropriate to fence off reservoirs to keep livestock out. This helps to maintain better quality water and avoids the problem of livestock getting stuck in the mud. Since fencing material is expensive and gets broken down by thirsty livestock, the planting of a live fence of cactus or similar thorny vegetation is much better.

#### Washing stands and bathing rooms

To prevent contamination of dam reservoirs by people washing clothes and bathing directly in the water reservoirs, it is advisable to build washing stands and bath rooms.

The waste water from washing clothes and from the hand-dug well should be diverted to irrigate a small vegetable garden. A watering trough for livestock, situated further downstream, should also be part of the water point.

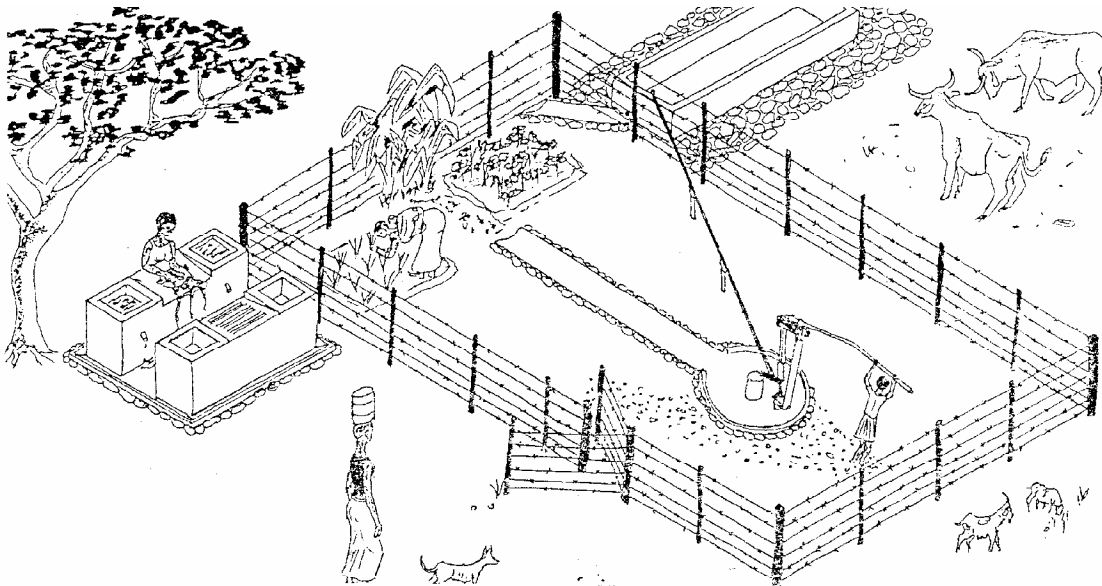

Washing stands and a watering trough at a hand-dug well downstream of a dam. (Source: DDF/Zimbabwe, 1990).

#### Latrines

Many rural people have a habit of relieving themselves behind a bush, instead of using latrines. During the rainy seasons, rainwater run-off washes the excrement into dam reservoirs where germs and pathogens can multiply and transmit human diseases. The use of pit latrines is therefore encouraged. Latrines must always be situated downstream of hand-dug wells.

The usual types of pit latrines with walls of burnt bricks and tin roofs are expensive and, due to poor craftsmanship, some latrines collapse during rainy seasons. Lack of ventilation pipes also give latrines bad smell and encourages flies.

A new type of latrine, the AborLoo, can be built for the cost of only one bag of cement, for making the slab. The walls and roof are made of locally available materials such as mats or sticks. The pit is dug to only 1 metre depth and covered with the slab. Dry soil mixed with wood ash is placed in a corner of the latrine and a handful of it dropped into the latrine after use, to avoid bad smells and facilitate the process of composting. When the pit is almost full, a new pit is dug nearby and the slab and walls are transferred to the new pit, and a tree is planted in the fertile soil of the old pit.

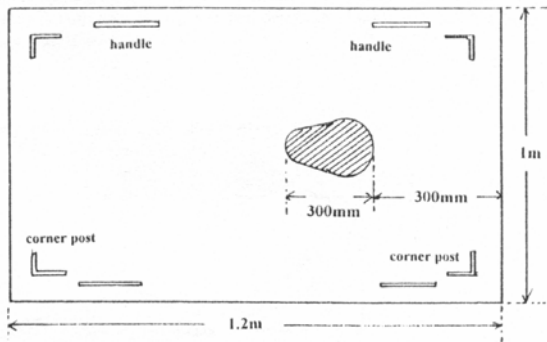

The removable slab for an Aborloo.

An Aborloo with walls of grass.

Source: Ecological Sanitation in Zimbabwe by Dr. Peter Morgan.

## 8.2 Catchment protection

It is important to implement catchment protection, also called soil conservation, on the land from where rainwater runs off into the dam reservoirs. Otherwise layer upon layer of silt and soil will fill up a dam reservoir, thus reducing the volume of water it can hold.

In the worst scenario, dam reservoirs will be filled to the brim with soil and cannot hold any water at all. Since de-silting of such reservoirs is more expensive than building new reservoirs, silted-up dams are often abandoned altogether. However, for dam reservoirs situated on sandy soils, a thin layer of siltation is beneficial because the silt seals the floor of a reservoir against seepage.

As soon as an earth dam has been built and is holding water, people will bring their livestock for watering and that is the beginning of siltation. Later on, if people start building houses near the dam and clearing land for agriculture without soil conservation, then siltation may reduce the lifetime of an earth dam to 8 years, or even less.

Catchment protection on farmland can be implemented in several ways such as:

**Maintaining the natural vegetation** cover within the catchment by avoiding over-grazing by livestock and cutting of trees for timber and charcoal

#### **Contour lines of fodder grasses**

Contour lines of fodder grasses, such as Napier Grass or the more drought-resistant Bana Grass, can be grown on contour banks, called Fanya Juu, to prevent a dam reservoir from silting up. The intervals between the banks depend on the gradient of the land. On land sloping about 3 cm per 100 cm, the distance should be about 20 metres. On steeper land the distance between the banks should be reduced.



Fodder grasses grow on the contour banks.

#### **Contour lines with multi-purpose trees**

Multi-purpose trees, such as Prosopis, Leucaena, Melia Volkensii and Azadirachta Indica (Neem), and bananas grow well in the ditches from where soil was taken to make the contour banks.

Contour lines of trees make windbreaks thereby reducing wind erosion of bare farmland. Windbreaks also reduce evaporation from water reservoirs by reducing the wind speed over surface water. Contour lines of trees improve rainwater infiltration for growing crops, and provide windbreaks, firewood, charcoal, fodder and timber.



Bananas planted in the ditch behind a contour bank, called a Fanya Juu.

### **Silt traps made of vegetation planted between stones**

Silt traps can be made of perennial vegetation planted between stones that are laid across the inflow channel to ponds and earth dams. The silt traps reduce the velocity of the in-flowing water thereby giving soil particles time to settle in and above the silt traps.

After flooding, most of the accumulated silt should be removed and used for fertilisation of adjacent farmland.



### **Check dams**

Check dams are almost similar to silt traps, but are usually made of large stones placed across inflow channels.

Perennial grasses are planted in soil packed in between the stones for "cementing" them together.



Without soil conservation, rainwater and wind will transport the top soil downstream where it silts up earth dams and riverbeds.

After the top soil has gone, the once fertile land will change to a lunar landscape with a stony surface cut by deep gullies, where nothing can grow.



## Chapter 9. Repair and maintenance

### 9.1 Leaking dam reservoirs

Newly built earth dams do not usually hold water for as long a period as expected during the first couple of years, due to leakages. The reasons and recommendations for curing leakages may be summarised as follows:

#### Leakage problems in reservoirs and recommended solutions

PROBLEM	REASON	SOLUTION
Water disappears through the floor of a dam reservoir.	The floor was not made water-tight, and holes made by rodents, rotten tree roots, old ant-hills, forgotten pits and trial pits, all drain water into the ground below.	<p>The holes must be sealed with clayey soil and compacted. Stones and boulders must be removed from the floor, as water can seep along them into the ground below. If some boulders are too large to remove, these should be covered with a thick layer of clayey soil to prevent seepage.</p> <p>Should a dam reservoir still leak after the floor has been prepared as described above, the floor should be compacted by either driving a tractor or a herd of cattle repeatedly over the floor of the reservoir until the soil has been compacted firmly.</p> <p>Should the floor of a reservoir still leak after compaction, it can be sealed (puddled) with a layer of water-resistant materials, such as clay, powdered ant-hills or lime, which are compacted onto the floor.</p>
Water seeps through a newly-built dam wall.	The soil in the dam wall contains air and water-filled voids.	The voids will be compressed and the seepage sealed by the weight of the soil in the dam wall itself. This process will be faster when the soil is moist and made flexible by water infiltrating from the reservoir, especially when it is full.
Water seeps under the key of a dam wall	The key does not seal a sandy layer situated deep under the key	The layer of sand can be sealed by placing a vertical and upstream-curved arch membrane made of thick plastic and/or ferro-cement along either the upstream or the downstream toe of the dam wall. An arched wall, made of plastic sheeting placed against ferro-cement and built along a raised stone apron at the downstream toe, has proved successful.

## 9.2 Washed-out dam walls

There are several reasons for a dam wall being washed-out, but the most common reason is that the spillways became blocked, or were made too small and therefore unable to discharge floodwater sufficiently quickly. The water level in a reservoir will therefore rise and flow over the dam wall at its lowest point and thereby create a wash-out.

Recommendations to prevent wash-outs of dam walls:

- Spillways must always be designed and built to their required width and depth.
- Any obstruction, including trees and bushes brought into a reservoir by floods, which block the spillway, should be cleared immediately.
- Dam walls must always be constructed and maintained, with their crests being at least 10% higher at the middle (convex) so that a wash-out will not take place at the middle of a dam wall, where it will require the greatest repair work, but at the end of a dam wall where it is easier to repair.
- The height of dam walls built without crawler compaction must be increased 30% to compensate for the settling of soil when the reservoir is flooded.
- The freeboard must be 1.5 metres on new dams. The freeboard may be reduced to 1.2 metres after a reservoir has been flooded several times and the soil in the dam wall has settled completely.



The wash-out of the Kimuu dam wall, which is described in this handbook, was due to heaviest rainfall in 72 hours for more than 50 years, and blockage of the spillways by trees that were uprooted by the rains.



### 9.3 Washed-out spillways

Spillways can be washed-out to such depths that they drain all floodwater out of their dam reservoirs either due to erosion caused by excessive floodwater, or because the floor of a spillway was not made to withstand erosion, as recommended below.

Recommendations to prevent washed-out spillways:

- A huge volume of rainwater runs off a large catchment during heavy rains. If a smaller dam is built with a large catchment, the reservoir will fill up with water quickly and a huge surplus of water will pass over the spillway, where it may cause erosion.
- It is therefore recommended that smaller valley dams (storage capacities below 10,000 m<sup>3</sup>.) should not be constructed in valleys with catchments larger than about 400 hectares (1,000 acres).
- Where the floors of spillways consist of sandy soil, they may be washed-out by surplus water from even small catchments. This can be prevented by either:
  - a) Planting drought-resistant and short perennial grasses with runners (Star Grass or Kikuyu Grass) in contour lines spaced about 30 cm across the floor of spillways.
  - b) Cover the floor of spillways with stones packed closely together and inter-planted with the type of grass mentioned above.
  - c) Construct low walls of stone-masonry as horizontal steps across the floor of spillways, where they will function as a staircase and reduce the speed of the overflowing water. The walls should be built in keys 30 cm deep and spaced about 2 metres apart.
  - d) The slope of the spillway floor should not exceed 3 cm in 100 cm.

### 9.4 Silted-up dam reservoirs

Rainwater transports topsoil and other light surface particles from a catchment to a dam reservoir where some of it settles to the floor of the reservoir as a layer of silt.

A layer of silt being only a few centimetres thick is beneficial to a dam reservoir because it reduces seepage, but thicker layers of silt decrease the storage capacity, reducing the volume of water and the lifespan of dam reservoir.

Catchments without soil conservation, and earth dams without silt traps, may result in dam reservoirs that cannot store any water at all within less than 10 years.

## References

- Brown, L.N. 1965. Small earth dams. University of California, USA.
- Gould, J. and Nissen-Petersen, E. 1999. Rainwater Catchment Systems for Domestic Supply. Intermediate Technology Publications, London, UK.
- Fowler, J. 1977 The Design and Construction of Small Earth Dams, Appropriate Technology Vol 3. No. 4, IT Publications, London.
- Hatibu, N. and Mahoo, H.F. 2000. Rainwater Harvesting for Natural Resource Management. RELMA/Sida.
- Hudson, N.W. 1975. Field Engineering for Agricultural Development. Clarendon Press, Oxford, UK.
- Kenya-Belgium Water Development Programme. 1992. Guidelines for the design, construction and rehabilitation of small earth dams and pans in Kenya.
- Mburu, C.N. 1995. Management of watershed & silt load. Kenya-Belgium Water Development Programme.
- Nelson, K.D. 1985. Design and Construction of Small Earth Dams. Inkata Press, Melbourne, Australia.
- Nissen-Petersen, E. 1990. Small Earth Dam built by Animal Traction. Danida, Kenya.
- Nissen-Petersen, E. 2004. Water from ponds, pans and dams. RELMA/Sida, Nairobi, Kenya.
- Norton, J. 1997. Building with Earth. Intermediate Technology Publications, London, U.K.
- Orlate, M.J. 1995. Guidelines for community participation in dams and water pans construction and rehabilitation. Kenya- Belgium Water Development Programme, Kenya.
- Shaw, D.N. and Rhod, M. 1977. A guide to design and construction of medium sized earth dams in Zimbabwe. Ministry of Water Development, Zimbabwe.
- Smout I. and Shaw R. 1996. Technical Brief 48: Small Earth Dams, Waterlines, Volume 14, No. 4, p15-19, Intermediate Technology Publications, London.