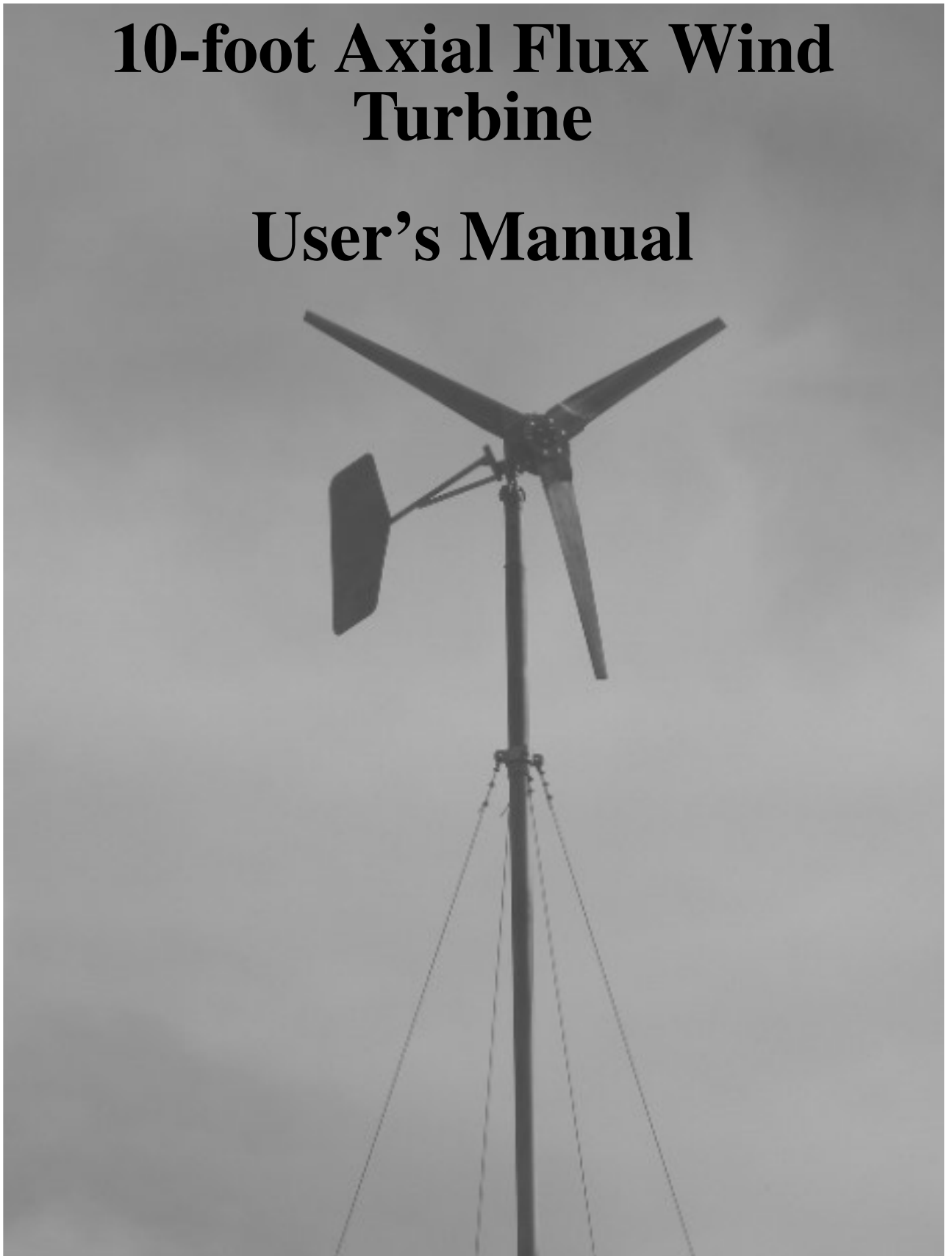


# **10-foot Axial Flux Wind Turbine**

## **User's Manual**



**[www.otherpower.com](http://www.otherpower.com)**



**© 2007 by Forcefield**

2606 West Vine Drive

Fort Collins, CO 80521 USA

(877) 944-6247 (toll free in USA) or (970) 484-7257

*windturbine@otherpower.com*

www.Otherpower.com

The Fort Collins address and phone numbers are for our in-town shipping and receiving office. Our staff cannot give technical support from this location. By far the best way to contact us is via the email address above, since we have satellite internet at our wind turbine shop.

*All rights reserved. No part of this publication may be reproduced, stored in a retrieval system, or transmitted, in any form, or by any means, including electronic, mechanical, photocopying, internet, or any other media, without prior permission of the copyright owner.*

**Authors:** Dan Bartmann and Dan Fink

**Copy editor:** Rich Carlsen

**Layout:** Dan Fink

**Shop foreman:** George Clous

**Shop dogs:** Flash, Morwen, Kodiak, Captain, Merlin

*All contents are provided in good faith and believed to be correct at the time of writing. However, no responsibility is taken for any errors, omissions, or future changes and updates. This publication will be updated regularly; check our website at [www.Otherpower.com](http://www.Otherpower.com) for any changes that have been made.*

*Neither the authors nor Forcefield take any responsibility for personal injury or death caused by any of the hazards of working with wind turbines. Safety is entirely the responsibility of the wind turbine owner and wind turbine installer.*

# Table of Contents

<b>Safety</b>	<b>5</b>
Electrical hazards	5
Mechanical hazards	5
Tower hazards	6
<b>Introduction</b>	<b>7</b>
<b>What did you just buy or build?</b>	<b>8</b>
<b>How much power will it make?</b>	<b>8</b>
<b>What's included</b>	<b>9</b>
<b>What's NOT included</b>	<b>10</b>
<b>What parts are which, and why</b>	<b>10</b>
Alternator	10
Blades	11
Tail boom	11
Tail vane	12
Blade hubs	13
<b>What you need to do before your wind turbine is ready to fly</b>	<b>13</b>
Let's get started	13
Assemble the tail	14
Rectifier assembly	15
Stop switch	16
Breaker and controller	17
System wiring	20
Tower	21
Test raise	28
Install the tower on the stub	29
Fit the tail	30
Assemble the rotor	30
Fit the rotor to the alternator	33
Balance the blades	34
Raise the wind turbine	35
<b>Troubleshooting</b>	<b>36</b>
<b>Regular maintenance</b>	<b>39</b>
<b>Sources</b>	<b>41</b>

# Safety

*Wind turbines can be dangerous!* And they are especially dangerous when you are installing or maintaining them. However, once your turbine is up and running on your tower, it should be a very safe and quiet machine if properly installed, wired and maintained. It is *your* responsibility to consider safety at all times when installing, maintaining and running your wind turbine. Do your homework, as we can't possibly cover every safety precaution here. If you are in doubt about anything, contact a professional! You can email us for technical support, too.

## Electrical hazards

- \* **Shock:** This wind turbine design puts out low voltage electricity, for system voltages of 12, 24 or 48 volts. Generally low voltages are not a shock hazard. However, when the turbine is not connected to the battery bank, voltages on the output wires can be *much* higher than that, enough to cause a dangerous shock. Always assume that every wire is energized and can electrocute you if you touch it! Shut down the turbine with the stop switch before doing anything with the wiring. Use electrical enclosures and conduit to keep curious fingers out of your wiring.
- \* **Fire:** Because of the low voltage nature of the wind turbine alternator, improperly-sized wires and poor electrical connections can get very hot very quickly and start a fire. Use electrical enclosures and conduit, and size all wires appropriately.
- \* **Heaters:** If you use dump load heating elements for your wind turbine, be sure they are mounted safely away from flammable walls and such, in a metal enclosure. The rectifier assembly can also get hot, use the same precautions for mounting it.
- \* **Grounding:** If your entire power system is grounded to National Electrical Code rules, that will most likely be all you need. See the *Grounding and lightning protection* section of this manual, page 41, for specific information about wind turbine grounding.
- \* **Balance of system:** Electrically speaking, this wind turbine is only as safe as the rest of your system. Your battery bank is particularly dangerous, due to the large amount of energy stored in a small space, and the emission of explosive hydrogen gas during charging. You should already be intimately familiar with every single safety precaution involved with the balance of your entire renewable energy system! It all needs to be installed safely, and most likely approved by your friendly local electrical inspector, before you even *think* of wiring your wind turbine into the works.

## Mechanical Hazards

- \* **Moving blades:** Don't ever fly a wind turbine on a tower that's so short that something or someone on the ground could touch it! This seems like plain common sense, but enthusiastic new turbine owners might be tempted to let the machine spin up in the wind on a short 'test' tower before mounting the turbine on the real thing. Don't do it! The machine could get away from you before you know what's happening (especially with no load on it) and the spinning blades could kill or seriously injure you, your guests, and your dogs. At the very least it would be

incredibly painful, and it *has* happened before to folks who we know. The *only* place you should fly your turbine is on a tall tower, out of reach of anyone or anything. If you put it on a short test tower (to balance the blades, or to prepare it for installation) short all the alternator terminals with jumper wires, *and* tie one blade to the tower with a rope, so it can't possibly spin, whatever the wind speed.

- \* **Ice:** If your turbine becomes coated with ice during a storm, shut it down with the stop switch. Read the section on icing, page 37, before turning it back on. Chunks of ice could be launched from the turbine at high velocity and for a great distance if you allow it run while iced up.
- \* **Inspect and maintain:** Pay attention to your wind turbine every day! If it starts making a strange sound or unusual motion, you need to shut it down and find out what's going on before a small problem leads to an "event cascade" that could result in total failure of the turbine, tower, or both. Unlike boring solar panels, all wind turbines need regular inspection and maintenance.
- \* **Pacemakers and medical equipment:** If you wear a pacemaker or other on-board medical equipment, be cautious around the turbine. The magnets used are extremely powerful! Though the magnetic fields are mostly contained within, close contact with the alternator could damage your pacemaker. You'll need to hire a helper to get the machine assembled and erected if this is the case.
- \* **Alternator disassembly:** If you need to replace the machine's stator for any reason, *contact us before attempting to remove the front magnet rotor!* Special tools are required to safely separate it from the machine, and if you don't use these tools and the proper procedure, your hands could be crushed between the highly attractive pair of magnet rotors. If you built the alternator yourself, you already know how to assemble and disassemble it, but you should still use caution.

## Tower Hazards

- \* **Solid construction:** No matter if you choose a tilt-up tower or one you have to climb, it *must* be solidly constructed and well anchored. The tower is no place to cut corners and save cost! Do your homework and anchor your tower properly. We recommend purchasing a tower kit for your first attempt, unless you can gain experience by tagging along with and helping a local wind turbine installer on a job site.
- \* **Climbing:** If you choose a tower that doesn't tilt down to the ground, you'll have to climb it to erect it, to install the wind turbine, and then climb it again at least once a year to maintain the machine. Or, hire a qualified wind turbine dealer to do this for you. You *must* be experienced in the art and safety of tower climbing to even think about attempting it, and must always use the proper fall protection systems available. You might consider taking a climbing and rigging class, or spend some time on a job site with a professional wind turbine installer to learn the 'ropes' of tower climbing.
- \* **Tilting towers:** Many wind turbine professionals consider tilt-up towers to be much more dangerous than towers you have to climb! The stresses on tilt-ups are extremely high during raising and lowering—one mistake in your design or your rigging and it could all come crashing to the ground when you first try to erect it. Think of yourself as the fly and the tower as the flyswatter. Any structures that might be in the fall zone are at risk, too. Again, we recommend that you take a class in wind turbine installation or spend some time on a job site with a professional installer to learn how to safely design, anchor, raise, and lower a tilting tower.

# Introduction

## (What have you gotten yourself into?)

Congratulations on your new wind turbine! This owner's manual is essential reading whether you've built the machine yourself from scratch, bought a parts kits from us and assembled it, or simply purchased a completed wind turbine 'kit' from us. These machines are really 'home built' wind turbines, even if yours came pre-assembled. And there is still a whole lot of work you'll need to do to prepare for the installation—most likely more work than it took to build the wind turbine itself. That's where this manual comes in, and hopefully you've read it *before* you bought anything! We have no giant factory teeming with technicians and engineers, no ISO 9000 certification, and no room full of offshore telephone operators standing by to tell you "reboot! reboot!" in garbled English —just a small, off-grid shop high in the Colorado mountains where we build wind turbine parts and kits, plus the occasional finished machine for sale. Our machine shop is powered entirely by wind, solar, and firewood—the nearest electric line is 12 miles away, there are no phone lines, and there is no cell phone reception.

The idea behind this 'home-built' machine is that it should perform as well as expensive commercial machines of the same size, be easy to maintain, and be easy to repair yourself when needed. Any part that breaks is simple to fabricate yourself (or purchase directly from us), *after* you figure out what caused the failure. This turbine starts producing power in 7 mph winds, gives stellar performance in low to medium winds, and sustained output of up to 700 watts in higher winds (about 25 mph), at which point the machine automatically turns out of the wind to protect itself while maintaining high output levels. You could easily see peaks of 1,000 watts in winds of 28 mph or above. This is among the quietest of wind turbines we've known—you'll probably be pleasantly surprised at the low noise level during operation.

However, this is *not* the lowest maintenance wind turbine design you'll find! The blades, blade hubs and the tail are wooden and will require at least yearly inspection and maintenance. The bearings are common tapered roller bearings and may require occasional greasing and adjustment. Solar panels have no moving parts, and are basically 'set and forget' units. Not so with wind turbines—*any* wind turbine for that matter! Regular inspection and maintenance are essential. In this owners manual we'll go over the assembly, installation and maintenance of these machines. If installed and maintained correctly, this will be a reliable, quiet and easy-to-live-with wind turbine.

Our shipping office in town has phone service, but our wind shop does not—we are too far off the grid for even cell phone service. We're happy to offer technical support and answer any wind turbine questions via email ([windturbine@otherpower.com](mailto:windturbine@otherpower.com)), and if email is not an option for you we can be contacted via snail mail or phone:

*Forcefield*

*2606 W Vine Dr*

*Fort Collins, CO, 80521*

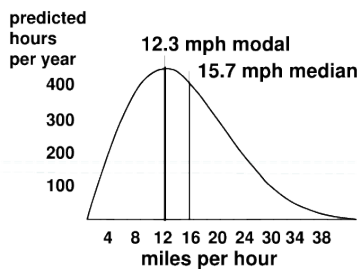
*Leave a message with a real human: (970) 484-7257 and (toll free in USA) 877-944-6247*

# What did you just buy or build?

You did *not* purchase a ‘turn-key’ wind power system along with a dancing troupe of smiley-faced chimpanzees to install it. You’ll need to do some significant preparation to even begin to think about starting to prepare to install your new wind turbine! The tower is a fairly complicated, potentially dangerous and very labor-intensive project all by itself, and it’s not included. Many folks are very excited when the wind turbine project is complete or the assembled machine arrives via UPS, but then reality sets in—it can take more time, money and work to build the tower than it took for the wind turbine itself. So their new wind turbine ends up moldering in a cluttered garage for a few years waiting for a tower, and the entire project is forgotten entirely. Usually a frustrated spouse then throws the wind turbine out with the trash while the builder or buyer is out playing golf or fishing, the half-completed tower is used for hanging wet laundry because the dryer broke, and the proud new wind turbine owners can’t afford to fix the dryer after paying for the wind turbine. Well, not always—but remember that the wind turbine itself is just the start of the project!

*This wind turbine is intended **only** for charging a 12, 24 or 48 volt battery bank. It can be grid-tied, but only through the battery bank and a grid-tie inverter. We (and many other folks who have built this turbine) are currently researching the design changes needed to tie this wind turbine to the grid without a battery bank, through a direct grid-tie inverter like the SMA WindyBoy. However, this will require a completely different stator design and is not possible at this time. Also, you **cannot** connect this wind turbine directly to air or water heating elements—you would need to design and build a sophisticated electronic controller to adjust the loading on the alternator to accomplish that.*

## How much power will it make?



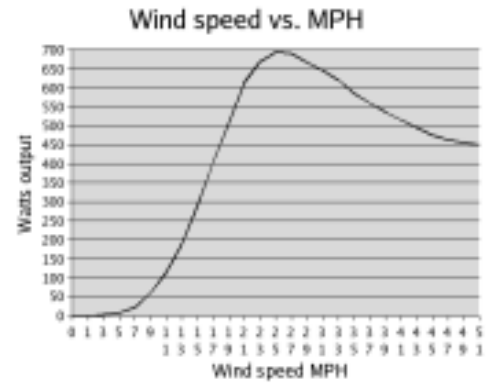
**Figure 1 - Typical wind speed distribution at most locations. In places with higher average wind speeds, the graph slides to the right, at lower average wind speeds it slides to the left.**

That depends on the average wind speed in your geographic area, your tower site, and the height of your tower. The higher the tower, the more wind ‘fuel’ is available to the turbine. You can’t predict how much power you’ll get by comparing wind turbines by their “rated output”—that number only tells what the turbine makes in high winds (usually 28 mph), and you can see from Figure 1 at left that such high winds are very rare in most locations—less than 100 hours per year. Most wind comes at us in the 10-20 mph range, and that’s what this wind turbine is designed to catch efficiently. But, the actual average wind speed at your location will make a big

difference in your monthly power production! You can look up average windspeeds on a map at [www.NREL.gov](http://www.NREL.gov). Another option is to fly a logging anemometer on a tall tower for a year. See the *Sources* section here for information on where to buy one.



In a good wind area on a tall tower, this 10 foot diameter turbine will likely produce between 90 and 120 kilowatt hours (kwh) per month. Considering that the average US home uses 750 kwh/month, that's not a lot—but for a remote, off-grid home that's designed from the ground up to be efficient, it can be a huge help and significantly reduce backup generator run time. Many off-grid dwellers combine both solar and wind into their systems, because in many locations when the sun isn't shining, the wind is blowing.



**Figure 2 - Approximate wind speed vs. power output curves of this 10 foot diameter wind turbine.**

This wind turbine is right up there with what most commercial wind turbines of similar size (9-10 feet rotor diameter) can make. Figure 2 shows an estimate of the power curve of this turbine at different wind speeds. The only way to get more is to install a taller tower, or get a wind turbine with a larger rotor diameter—that's just basic physics. But you can see that the turbine will give excellent performance in the 10-20 mph range, which is by far the most common wind distribution in most locations. At a site with a high average wind speed, the graph of wind speed distribution in Figure 1 would 'slide' to the right by a couple mph; at a site with lower average wind speed it would move to the left. The difference in average wind speed at a marginal location compared to that at an excellent location would only be at most 4–5 mph—but the difference in power production would be quite significant!

## What's included:

- \* Alternator, consists of:
  - Frame
  - Spindle and bearing
  - Magnet rotors
  - Stator
- \* Tail assembly, consists of:
  - Tail boom
  - Tail vane
  - Tail assembly hardware:
    - 5/16 inch – 18 tpi bolts with washers, lock washers, and nuts (qty 6 of each). Four of the bolts are 1 inch long, two of them are 2 inches long
- \* Wooden blades, each 5 feet long (qty 3)
- \* Blade hub set, consists of:
  - Plywood blade hubs (qty 2)
  - Steel blade hubs (qty 2)
  - 1-1/4 inch long wood screws (qty 60) for attaching blades to hubs
  - 5/16 inch-18 tpi carriage bolts with washers, lock washers, and nuts (qty 6 of each) for attaching blades to wooden hubs
  - 1/2 inch-13 tpi nuts and lock washers (qty 4) for attaching rotor to alternator.
- \* Yaw bearing bushing
- \* Lead weights and wood screws for blade balancing

## What's NOT included:

- \* An installed, functioning, battery-based renewable energy system, running at 12, 24 or 48 volts
- \* Blade finish
- \* Tower and all its components, including:
  - Pipe or tubing for tower and jin pole
  - Couplers and guy wire connectors for tower and gin pole pipe
  - Turbine mounting stub
  - Guy wires, guy wire anchors, tower base, turnbuckles, thimbles, and cable clamps
  - Winch system, truck, pack of dogs, or tractor for raising and lowering the tower and wind turbine (or, tower climbing gear, safety equipment, and years of training if you are planning to climb your tower)
  - Inspection, engineer's drawings and approval from your favorite local government agency, if required
- \* Wiring from tower top to power system
- \* Rectifier assembly
- \* Shut-down switch
- \* Controller and dump load (optional but recommended)
- \* Metering (optional but recommended)

## What parts are which, and why

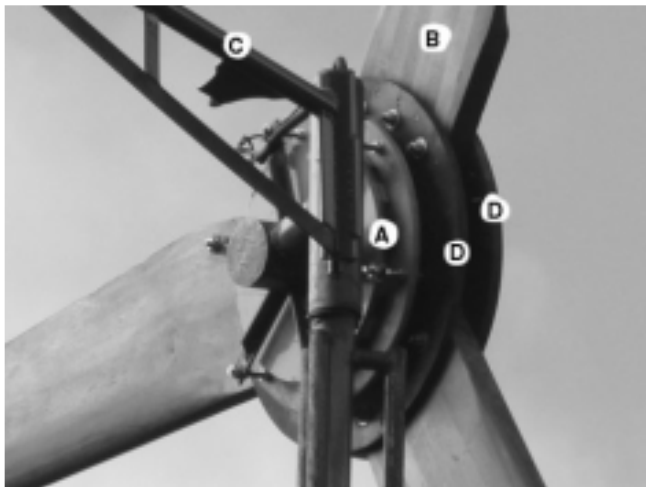


Figure 3 - A wind turbine, with all the essential parts labeled:

- A) Alternator
- B) Blades
- C) Tail boom
- D) Blade hubs

### *A) Alternator*

The alternator (A in Figure 3, above left) converts the mechanical energy put into the rotating shaft by the wind pushing the blades into 'wild' 3-phase alternating current (AC) electricity that varies in frequency. It is a low-rpm, axial flux permanent magnet unit, very much inspired by Hugh Piggott's designs. The alternator itself consists of two magnet rotors that turn together (Figure 4, #2, facing page), directly coupled to the blades. One magnet rotor is on each side of the stator (Figure 4, #1, facing page), and each magnet rotor contains 12 Neodymium-Iron-Boron

(NdFeB) rare-earth magnets of extremely high flux. The stator contains 9 coils wound with copper wire and cast into plastic resin, in line with and between the paths of each magnet. The output of the alternator comes out on 3 wires or 3 brass studs. This alternator will start charging batteries at about 140 rpm and reach rated output of 700 or 1,000 watts at about 450 rpm. The specifics depend on the distance of wire run, the gauge of wire used, your battery bank size and your battery bank voltage.

The frame (#3 in Figure 4) simply holds everything together. The yaw bearing (#4 in Figure 4) is the point on which the turbine pivots to face the wind, or to face itself out of the wind when wind speeds get too high. The tail pivot (#5 in Figure 4) holds the tail assembly, allowing it to swing when wind speeds get too high, with the wind turbine following it by pivoting on the yaw bearing.

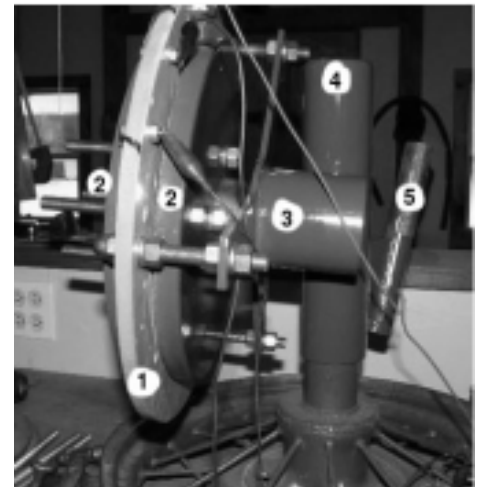
## ***B) Blades***

The blades are fabricated from laminated Western red cedar. We use this wood because it's strong, lightweight, reasonably inexpensive and resists rot. We normally finish the blades with a few thick coats of boiled linseed oil. In humid environments a good paint finish would probably hold up better. We'll discuss blade finishing in the *Final Assembly* section here, as the blades ship from our shop unfinished.

The blades are twisted along their length (in other words, the blade pitch varies from shallow at the tips to steep at the roots) to approximate the correct angle of attack to the wind—the twist is because the tips of the blades are moving faster than the roots. These blades are designed to run at a tip speed ratio (TSR) between 6 and 7, and are matched to the alternator. For information about the blade design we use, refer to our website [www.otherpower.com](http://www.otherpower.com).

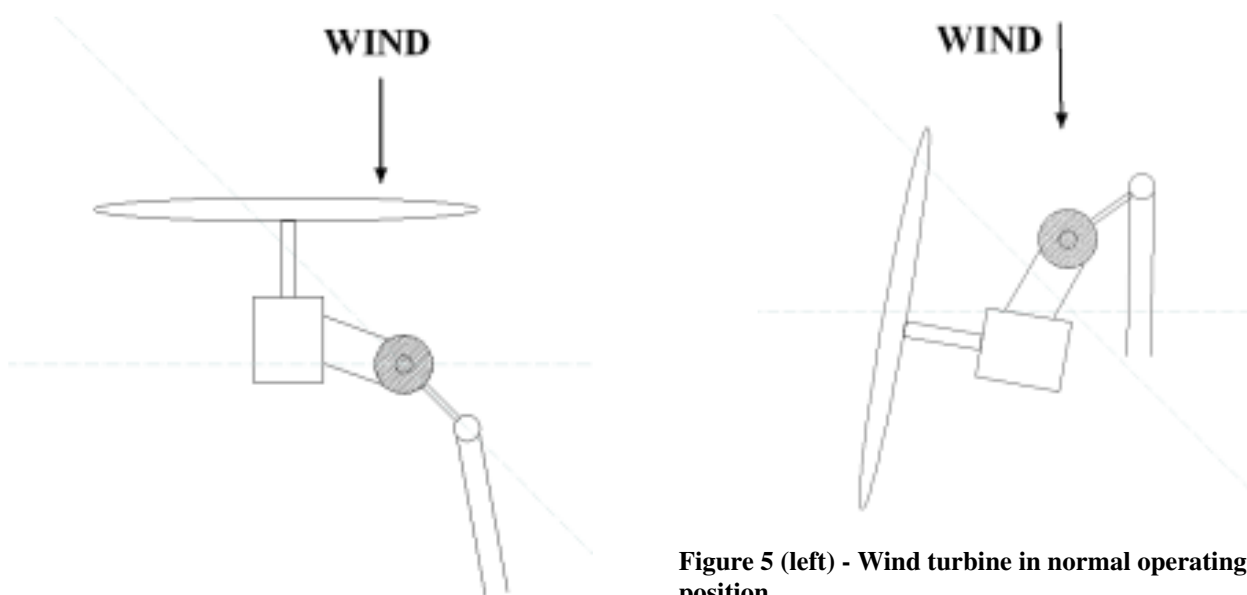
## ***C) Tail Boom***

The tail boom is a bit over 5 feet long, fabricated from steel pipe and steel bar stock. It fits over the tail pivot (Figure 4, #5) on the alternator. The alternator and tail work together so that in high winds the thrust against the blades will overcome the weight of the tail—the machine will fold up and “furl” to reduce the effective swept area of the blades. To “furl” means that the machine turns out of the wind on its yaw bearing (Figure 4, #4), so the blades don't face square to the wind. In higher winds you can expect the power of the machine to be slightly reduced while it protects itself—but it should still produce nearly full power under these conditions.



**Figure 4 - Alternator with parts labeled:**

- 1) Stator
- 2) Magnet rotors
- 3) Frame
- 4) Yaw bearing
- 5) Tail pivot



**Figure 5 (left) - Wind turbine in normal operating position.**

**Figure 6 (right) - Wind turbine fully furled to protect itself from high winds (over 28 mph).**

This protection system (called a “furling tail” and shown in Figures 5 and 6 above) is very simple in that it works simply by the geometry of the machine’s frame, requires no mechanical components like springs that can break or ice up, and simply allows gravity to return the wind turbine back to normal operating position when the wind drops back to normal levels (below 25 mph). Figure 5 above left shows the turbine in normal operating position, and Figure 6 above right shows it fully furled and protecting itself, while still making near maximum output. Furling tails were invented in the mid-1800s, but were perfected for small electricity-generating wind turbines by Scottish homebrew wind guru Hugh Piggott.

## ***Tail Vane (Figure 7, below)***



**Figure 7 - Tail vane bolted to the tail boom.**

The tail vane is made from high quality 1/4 inch thick birch plywood. Since it is wooden, it should be treated generously with linseed oil, paint or stain to protect it from the elements. We discuss this in detail in the *Final Assembly* section later in this owners manual. Should the tail vane ever start to rot it’s easily replaced! Keep in mind though—the weight of the tail helps determine when the machine will start to furl and protect itself, so you might be on risky ground if you rebuild the tail with thicker wood or in a different size or shape. We use

birch plywood because it’s strong, light weight and resists fatigue cracking. As long as you put finish on the tail vane before flying it on the wind turbine (and re-apply finish during your yearly annual maintenance), it should last for years.

## ***D) Blade hubs***

The wooden blade hubs (D in Figure 3, previous page) provide a sturdy attachment point for transferring power from the blades to the shaft. There are also two metal blade hubs (one in front of the wooden blade hubs and one in back) that give a sturdy surface to ‘sandwich’ the whole blade and hub assembly together with bolts. The wooden blade hubs are provided unfinished, and the details on finishing them are provided in the *Final Assembly* section. You’ll do it whilst finishing all the other wood parts on the machine, including blades and tail vane.

## **What you need to do before your wind turbine is ready to fly:**

As you (hopefully) already know from reading our literature and this owners manual before purchasing or building your wind turbine, you first need to have a renewable energy power system in place. There must be something to connect the turbine output to! This wind turbine will work *only* for charging the battery bank of a renewable energy system—you *cannot* use the turbine’s output directly, run heating elements directly, or tie the output directly to the power grid. Such direct grid-tie (no battery bank) inverters like the SMA WindyBoy® require a specially-built stator to be installed in the wind turbine, which we do not offer at this time. You *can* easily use this wind turbine for grid-tied systems without issues, but *only* if the wind turbine is charging a 12, 24 or 48 volt battery bank.

The wind turbine’s stator must be built differently for different system voltages. Be sure that you have the correct stator for your system voltage before installing—it will be marked for either 12, 24 or 48 volt systems. It’s no problem to add this wind turbine as an input to an existing grid-tied, battery-based power system, but the grid-tie inverter, battery bank and balance of system components must already be in place, inspected and approved by the power company, and functional before you proceed with adding the wind turbine. If you ever change the system voltage of your RE battery bank, you can simply replace the stator of this wind turbine with one designed for the correct system voltage—all other components of the alternator and wind turbine stay the same.

## ***Let’s get started***

The steps you’ll need to complete to get your new wind turbine flying are as follows, and below we’ll cover each step in detail:

1. Assemble the tail
2. Build or purchase the rectifier assembly, and install it into your battery-based RE system
3. Purchase and install the shut-down switch
4. Purchase or build the controller, breaker and dump load, and install them into your RE system (optional but recommended)

5. Install the wiring from the tower base to your system
6. Install a sturdy tower, and fabricate or purchase a tower-top stub
7. Test raise the tower and adjust the guy wires
8. Install the turbine on the tower-top stub
9. Install the tail vane on the tail boom
10. Assemble the blades into a rotor and attach to the alternator
11. Balance the blades
12. Raise the turbine and tower
13. Relax, have a beer, and watch the power come in! Wind turbine watching is far more entertaining than television.

## ***1) Assemble the tail***

If we built the machine and shipped it to you, the tail consists of three pieces. The tail boom (the long piece made from pipe that fits onto the alternator over the tail spindle), the tail bracket (a 34 inch long piece of steel bar stock) and the wooden tail vane. You'll assemble the tail as follows. The hardware is supplied, and consists of 6 x 5/16-18 bolts with washers, lock washers, and nuts. Four of them are 1 inch long, and two of them are 2 inches long.

Use two of the 1 inch long 5/16 inch bolts to attach the wooden tail vane to the tail



**Figure 8 (left) and Figure 9 (right) - Assembling the tail.**

boom. Insert the bolts through the holes near the ends of the the steel bar stock. Fit the tail vane over the bolts. Then put a washer, lock washer and a nut on the 'wood' side and tighten the bolts (Figure 8).

Use the other two 1-inch bolts and bolt the tail bracket/tail vane to the tail boom as pictured above in Figure 9. Again, the washers, lock washers and nuts should be used against the wooden side of tail vane. Use the two longer bolts to bolt the wooden tail vane to the tail boom. The washer, lock washer and nuts should again go on the wood side.

## 2) Rectifier Assembly

The wind turbine's output comes as 'wild' 3-phase alternating current (AC). It's not usable in this form because the frequency varies with the wind speed and rotor speed. So, the wild AC must be rectified into DC for battery charging. The easiest way is to buy a ready-made 3-phase rectifier of suitable current carrying capacity, mount it to a big heat sink, and add a stop switch and (possibly) an ammeter. Many good electronics suppliers will carry 3-phase rectifiers—but they can be a bit expensive (\$50 - \$150 depending on the current rating). We find that these are almost always available as surplus off of Ebay and from other surplus suppliers, and can usually be had for less than half the new price. These devices are nice because no construction is required. They have terminals for three wires coming in (3-phase AC in from the turbine) and two wires out (positive and negative DC). A typical model is shown in Figure 10.



Figure 10 - A pre-made, 3-phase rectifier.

You can also build a suitable rectifier with 6 diodes (Figure 11) or with easily available single phase bridge rectifiers (Figure 12). These options might be cheaper, but they take more work for wiring and assembly.

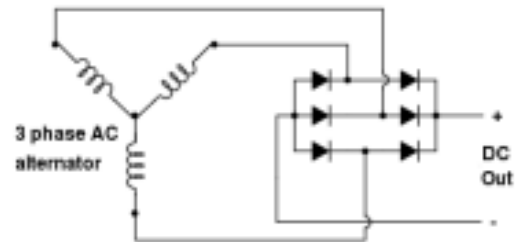


Figure 11 - 3-phase rectifier built from 6 diodes.

### Sizing the rectifier

The power handling capacity of your rectifier assembly *must* be larger than the maximum output of the wind turbine. We size ours for 1,500 watts of turbine output, even though the maximum you'll likely ever see is 1,000 watts—better safe than sorry. The table below shows the amperage capacity needed in the rectifiers for this turbine depending on what system voltage your battery bank is wired for:

**48v = 40 amps**  
**24v = 80 amps**  
**12v = 150 amps**

You can see why we try to discourage 12v power systems—the rectifiers to handle that huge 120 amps from your turbine can be expensive, all the wiring from your turbine to your battery bank will have to be large and expensive (Sections 6 and 7 below), and your controller (Section 3) will have to be huge and expensive too.

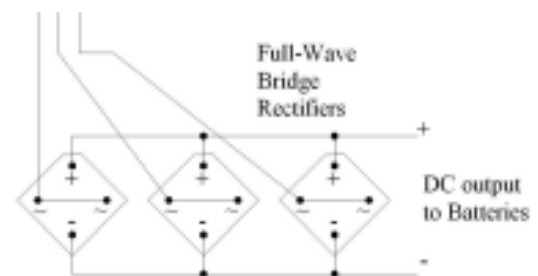
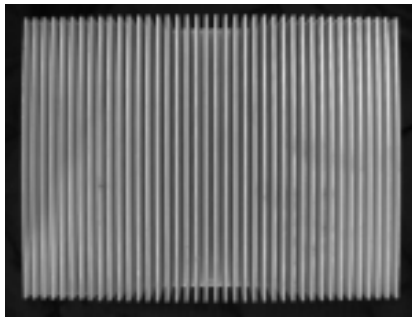


Figure 12 - 3-phase rectifier built from 3 standard full-wave bridge rectifiers.



## Heat sink

Once you buy or build the rectifier itself, you'll need to bolt it down to a nice big aluminum heat sink (Figure 13). As you saw from the table above, the lower the voltage of your system, the higher the current will be and the larger your heat sink will need to be. Use a coat of specially-formulated 'heat sink compound' (available from most electronics stores) between the heat sink and the rectifier to assure good thermal contact.

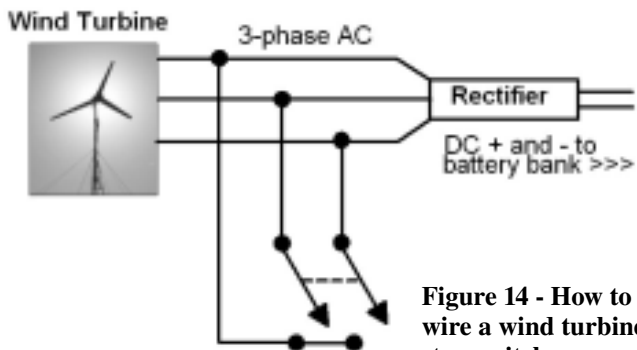


**Figure 13 - A nice, large, and expensive aluminum heat sink, shown from above (top) and from the side (above).**

Any rectifier that's *not* properly heat sunk will burn out within minutes during higher winds, so don't skimp—the heat sink and a good thermal connection between it and the rectifiers are essential. They won't carry anywhere close to their rated current without a heat sink. Nice large heat sinks can often be salvaged from old power

inverters or car stereo amplifiers. Some folks have even used finned aluminum cylinder heads from old engines.

## 3) Stop Switch



**Figure 14 - How to wire a wind turbine stop switch.**

All wind turbines need a shut-down switch. With this turbine, all you need to stop the blades quickly is a big switch to short all three incoming phases to each other, somewhere between the wind turbine and the rectifier. You'll use this switch to shut everything down during raising and lowering, for protection during extreme winds, and in case something goes badly wrong up there on the tower or in your RE system wiring while the wind is blowing. The switch should be a double pole, single throw (DPST)

switch rated 30 amps or more, and the schematic of how it should be wired is shown in Figure 14 at left.

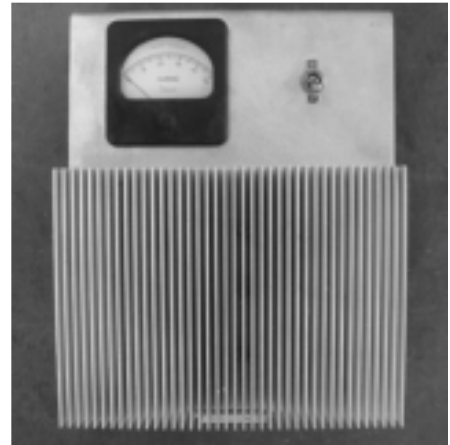


**Figure 15 - A typical 30 amp double pole, single throw (DPST) switch.**

Such switches (Figure 15 at left) are available inexpensively at any electronics supplier. Though the switch seems puny compared to the amount of current that the turbine can produce in high winds (especially in a 12 volt system), remember that the switch only sees high current for an instant, and after that the turbine is almost stopped and is producing very little power. When the stop switch is



engaged (so that the alternator is shorted), it all becomes very stiff to turn and the machine will stop or just barely turn, no matter how high the wind speed is. It's best to stop the machine during a lull in the wind when it's already running slowly, but the switch should effectively stop the machine at any speed. It's hard on the stator and the blades to be stopped quickly in high winds (you may hear an audible 'clang'), but we've never damaged a machine here by doing it. Note that some commercial wind turbines *cannot* be shut down during high winds—the switch is simply ineffective! We think the fact that this axial flux air gap alternator can be positively and firmly stopped during the most horrific high wind situations is a definite advantage. Hurricanes, tornados, cyclones, gales and nor'easters can happen, and it's not wise to run a wind turbine during one.

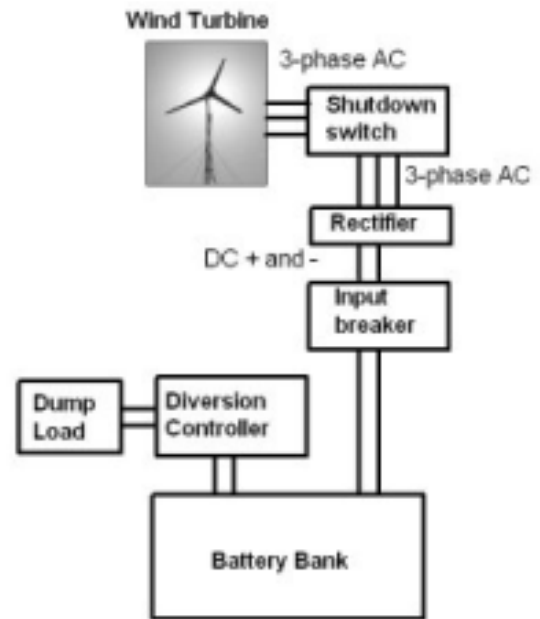


**Figure 16 - The completed rectifier / heat sink / stop switch / ammeter assembly that we usually build for our wind turbines.**

Figure 16 at right shows the standard rectifier/stop switch/ammeter unit that we build here and use for most of our wind turbines. It's handy because everything is right there in one box. When you first raise your wind turbine and it's operating, take the time to feel your rectifier's heat sink. On windy days, if the unit is getting 'hot' then you likely need a larger heat sink. There's no such thing as a heat sink that's too big—and it should never get much more than 'warm to the touch.'

#### 4) Breaker and controller

Figure 17 at right shows it all. You need to bring 3-phase AC power to your rectifiers through the shutdown switch. Then you'll be down to 2 wires, + and - DC, which go through the input breaker to your battery bank. The controller then diverts it from the battery bank.



**Figure 17 - Wind turbine system wiring diagram.**

#### Input breaker

From the rectifiers you should go through an input fuse or breaker. It's also required by the NEC electrical code. This should be quite a lot larger than the maximum current you'll ever see from the wind turbine—if the fuse blows or the breaker trips, the wind turbine will be free spinning with no load on it, which is a dangerous condition. If this ever happens (very unlikely) you should stop the wind turbine with the shutdown switch immediately.

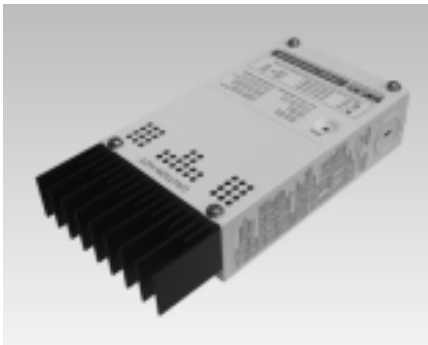
We suggest at least a 50 amp fuse or breaker for a 48 volt machine, 100 amps for 24 volt, and 200 amps for a 12 volt machine. Label the breaker clearly, it's *not* the same as the stop switch! It's more like a 'self destruct switch' if accidentally opened by a human during high winds. The most likely reason this breaker would ever trip would be serious problems—a major short circuit in the controller or battery system wiring, which is extremely unlikely.

## Controller

From the rectifier, you are now running DC power to your battery bank on two wires, a large + and a large – wire. Your batteries are an integral part of the wind turbine's alternator—they clamp the wind turbine's open-circuit voltage down to the system's level, *until* the batteries are full. At that point system voltage will rapidly climb to levels that can damage your system equipment and bubble away the water in your battery electrolyte, producing explosive hydrogen gas. To avoid this condition, you need to install some sort of controller.

The simplest and least expensive controller is manual—if your batteries are full and the wind turbine is still producing power, simply turn on more loads, like lights, stereos, televisions, vacuum cleaners and dishwashers. If you can't consume enough power to keep battery voltage down, just stop the wind turbine entirely with the shutdown switch.

Unless you are home all the time, though, it's much safer to have an automatic controller. Wind turbines need to have a load on their alternator *at all times*, unlike solar panels that can simply be disconnected from the system at any time. A wind turbine with no load on it is 'freewheeling' and can overspeed, which is a very dangerous condition! The furling system will not work properly if the turbine is overspeeding, and the machine has no way to protect itself from high winds. So, an automatic 'diversion load controller' should be installed to divert wind turbine power to a 'dump load' when your batteries are full—usually the dump load is an array of air- or water-heating elements.



**Figure 18 - A Xantrex C-series diversion load controller.** *Photo courtesy of Xantrex Technology Inc.*

Controllers that do this are readily available. The Xantrex C-series (Figure 18) or the Morningstar/Tristar TS series are common choices, and can be converted to run in diversion mode (instead of solar panel mode) with the flip of a switch. However, once again 12 volt systems get tricky! At 12 volts the machine could easily produce over 80 amps, and neither of those diversion controllers are up to the task—you'd have to use multiple controllers wired in parallel, which is an expensive proposition. With a 48 volt system, you could get by with an inexpensive 40 amp controller.

The chart below shows the recommended controller capacity for each system voltage:

**12 volts = 130 amp controller**

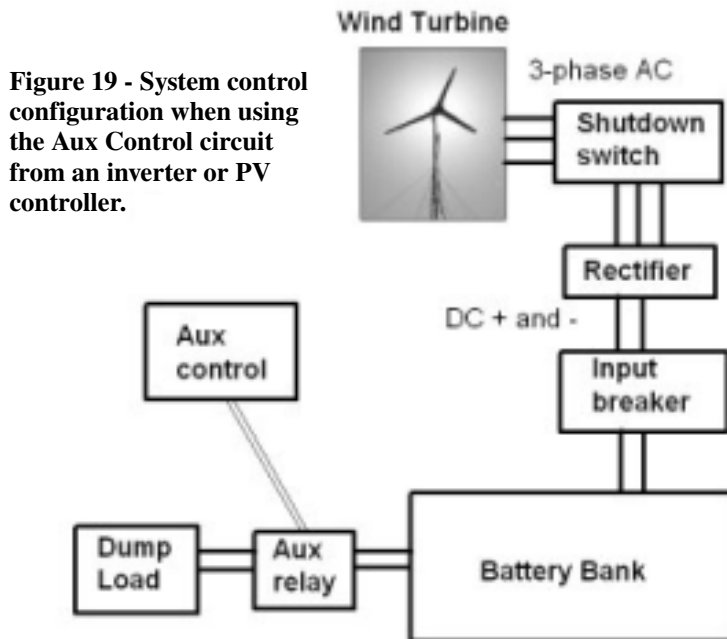
**24 volts = 60 amp controller**

**48 volts = 40 amp controller**

Designing and building your own diversion load heating elements can also be tricky. These ‘dump loads’ must be sized large enough to use the entire diversion output of your controller, which itself should be able to divert the entire wind turbine output during high winds. So, we recommend that you size them for 1,500 watts of potential output. The resistance must be exactly right also, to assure that they draw the correct amount of power. We also advise that you simply purchase the correct dump load heating elements from the company that supplied you with your controller, instead of trying to design and build your own.

A less expensive alternative to a commercial controller is to use a voltage-controlled switch with hysteresis. Many high-end inverters and PV charge controllers have these built in, often labelled as auxilliary relays (Aux). Instead of diverting a differing amount of power from the batteries to the heating elements as the wind turbine makes more or less power, this simplified system just turns on the heaters full blast until the battery voltage again drops to a reasonable level. The heaters can be either 120 volts AC house current from the inverter, or DC elements connected with very thick wire directly to the battery bank. The voltage-controlled switch on a standard inverter or controller can’t handle much power. You’ll need to use it to turn a much larger relay on or off to start and stop the heaters, just like how the ignition switch and starter relay in an automobile work—the ignition switch you put your car key into switches only a small amount of power to drive a big relay that allows a whole bunch of power from your battery to flow straight into your starter motor. The relay should be sized to match

If you have a large and high-tech inverter or PV charge controller, it can be less expensive to use the Aux controller on that equipment to switch 120 volts AC house current to a standard electric heater. But, remember that this dump load should draw up to 1,500 watts from your inverter! If the inverter is too small, you won’t have any power left to run normal household loads, and the inverter will shut down or blow up. If you *do* run DC heating elements directly, size the wire appropriately, and use a mercury contactor or solid-state relay—most ‘normal’ AC relays break down quickly under the high amperage load of a



**Figure 19 - System control configuration when using the Aux Control circuit from an inverter or PV controller.**

low-voltage DC heating element. DC water heating elements are actually quite easy to find at renewable energy suppliers, so you can easily replace the element in a standard 120 volt AC water heater with a DC version for your dump load. You'll also have to set the correct hysteresis setting so that the contactor doesn't cycle on and off too quickly—the setting will depend on the size and condition of your battery bank. If you go with the Aux relay diversion system, your wind system diagram would look like Figure 19, above.

## 5 ) System Wiring

The wire from the wind turbine to the rectifiers and battery needs to be sized according to the current that the wind turbine might generate, and the distance between the wind turbine and the batteries. The lower the voltage the higher the current—this is yet another reason higher voltage systems are easier to get along with and less expensive.



**Figure 20 - Locking plug and socket at the tower base.**

A heavy duty, locking 3-prong electrical plug (Figure 20, at left) on the 3 wires coming down from the turbine, and a matching socket that's connected to the wires. You need to size the plug and socket for the same amperage rating as your controller. When you price the plug and socket at the electrical supply store, you'll once again see how higher-voltage systems save money! We highly recommend a locking plug and socket, as you do *not* want this connection to come loose accidentally. It's also handy to buy an extra plug and wire it so it's a dead short—insert this into the turbine output plug, and you can stop the machine immediately.

As you'll read later in the section on turbine maintenance, every couple weeks you'll need to check this plug and socket to see if the pendant cable wires have twisted. If they have, you'll simply unplug at the bottom of the tower, untwist the wire, and plug it back in. Insert the extra shorting plug that you made to stop the turbine while you perform this untwisting operation. The more turbulent your tower site is, the more often you'll have to untwist. Tall towers on excellent wind sites might need untwisting only 3–4 times a year, while turbines mounted on too-short towers in bad locations could need this weekly.

The wire run from the alternator to the tower base is different than the wire from the tower base to the rest of the system. This turbine design doesn't use slip rings to get power from the alternator down the tower; instead we use a simple, easy to build, and more reliable system called a 'pendant cable.' This wire runs down to the ground inside the tower pipe, and actually twists as the wind turbine yaws to face the wind. You should select the best grade available of flexible, stranded #8 or #10 AWG extension cord wire for the tower wiring. At the tower bottom, you'll need to install a heavy

From your socket at the tower base to your rectifier, you'll most likely have a long run of wire. The lower your system voltage, the thicker this wire will have to be, and the longer your wire run, the thicker your wire will have to be. And the thicker the wire, the more expensive it will be! If you ran the possible maximum output of the wind turbine (1500 watts) through the wire sizing formulas for solar PV systems (usually for only 5% loss), you'd be told to use extremely thick and expensive wire. Fortunately for your wire budget, the turbine will produce 1,000 watts or over very rarely, since high winds are so rare. And during such windy periods, you'll have full batteries pretty quickly. So you can size the wire for a lower output, and accept more line loss at higher wind speeds.

However, there's a limit to how much loss you can accept. The more power that's wasted, the faster the wind turbine will run and the less efficient the system will be overall. If the wind turbine runs too fast (too much power wasted in the line), the blades will become less efficient. They may also become noisy and the machine may not furl properly. An overspeeding wind turbine is dangerous and one more reason to make sure you size the conductors appropriately. So, the wire size recommendations in the chart below should be considered the minimum thickness of wire to use. It won't harm anything to use thicker wire, but it will be more expensive.

	Up to 100 ft	200ft	300ft	400ft	600ft	800ft	1000ft
12V	8	6	4	2	0	2/0	4/0
24V	10	8	6	4	2	0	2/0
48V	12	10	8	6	4	2	0
		# AWG					

## 6) Tower

The tower might end up being the most difficult and most expensive part of your entire wind turbine project! Don't underestimate how much time, labor and money the tower project will take. It will likely cost *more* than your wind turbine did, and will take longer to build. A sturdy tower is *essential* to success with a wind turbine—and you don't want to underestimate how much force will be pushing against the tower top! Better to pay a bit extra to overbuild than to underbuild and risk having the turbine and tower come crashing to the ground.

### Purchase a tower, or design and build your own?

In short, we recommend that for installing your first wind turbine, you should buy your first tower kit instead of designing and building it yourself. Such a kit will come with all the needed parts—such as couplers between the tower sections, guy wires, guy wire equalizers, thimbles, cable clamps, tower base, hinge, gin pole and approved engineer's drawings to make your friendly local building inspector happy. If it's a tilt-up tube tower, you'll most likely have to supply the steel tubing or pipe yourself. We list many sources of tower kits in the *Sources* section of this manual. Even if you buy a tower kit, you'll still have to provide the tower stub and adapt it to fit the tower top. And you'll have to provide a sturdy foundation and sturdy guy wire anchors.

If you *do* tackle the problem of designing your own tower, there are some resources available. Most tower kit manufacturers let you download the entire specification sheets for their towers for free on the internet. Get all of these that you can, and read them thoroughly. A tower designed for a commercial 10 foot rotor wind turbine will be just what you need for a homebrew 10 foot wind turbine—the forces on the tower will be very similar. If you have a local renewable energy installer that does wind turbines, ask if you can join them to help on a tower and turbine install sometime. Most will be grateful to have extra eyes and hands during the somewhat dangerous process of erecting a tower, and you'll gain invaluable knowledge for your own tower design and installation.

## Height

Flying a wind turbine on a short tower near obstructions is like mounting a solar panel in the shade! Wind speeds are much slower near the ground, and any obstructions nearby form a 'pool' of slow-moving air in all directions from the obstacle. In addition, both the ground and obstacles cause turbulence, which lowers power output and puts unnecessary stress on the machine. A good rule of thumb is that any wind turbine should be flown at least 30 feet above any obstacle (in any direction) within 300 feet. Many wind power experts recommend even taller towers and more distance from obstructions than that. Don't skimp on tower height—it's the most important thing you can do to assure good power output and long life of the wind turbine.

## Government ordinances

Many local governments have restrictions on tower heights. Above a certain height, you may need a special permit, which will often entail submitting certified engineer's drawings of the tower. Most local regulations require that if the tower should fall, all of it would land entirely on your property. If you live close to an airport, you may have to check with the FAA for tower restrictions and lighting requirements—however, if you are more than 4 miles from an airport no special permission is required from the FAA unless the tower is 200 feet tall or over.

In general, the more rural and remote your area is, the fewer regulatory hassles you'll have to endure in getting permission to erect your tower. You should check into all of this before even considering building or buying a wind turbine. Many cities won't allow tall towers at all. This has led to the promotion of 'rooftop wind turbines,' which are a very *bad* idea! Rooftop towers are not generally high enough to get above obstructions, they put extreme forces on your house that it was not designed to take, and the vibration from the wind turbine will likely be *very* irritating during a wind storm. Even quiet wind turbines like this one transmit vibration to the tower when they are generating power, and you'll be able to hear and feel this vibration quite clearly. We strongly urge you to not even *consider* a rooftop wind turbine tower. If you *do* build a rooftop mount, don't come crying to us if your windmill makes very little power, keeps you awake all night, or causes your house to fall down!

## Neighbor relations

You'll want to discuss your wind turbine and tower project in advance with any neighbors who are near enough that they'll be able to see your turbine. They may be concerned about noise, visual aesthetics, and bird and bat kills. It might pay off in the neighbor relations department to paint your tower and wind turbine white or light blue to lessen their visibility against the sky. Strobing can be an issue, where for a couple weeks during certain times of year, the sun will be directly behind the spinning blades for a few minutes, casting a moving, flickering shadow on their home.

Noise is generally *not* an issue with this wind turbine design, it's one of the quietest we've seen. We generally describe the noise as being similar to someone riding by outside on a bicycle, and usually the wind in the nearby trees is much louder than the turbine itself. Tower vibrations can also cause noise, but this can usually be remedied by small modifications to the tower structure to prevent rattles.

Birds and bats are generally non-issues with small wind turbines, though your neighbors may be mis-informed and believe otherwise. All the bad press surrounding wind turbine bird and bat kills misses the most important fact—*all* tall, man-made structures kill flying animals. It's *not* the rotating blades that do the damage, it's the tower itself and any guy wires attached! Utility-scale wind turbines on giant towers are responsible for all the bad press about bird kills, not small 10 footers like this one. Small wind turbines are rarely flown on towers higher than 100 feet. We have never heard of a case where a small, home-sized wind turbine has killed an animal. (Exception! Read Rex and LaVonne Ewing's book "*Power with Nature*" for an example, and find a way to keep your cats from climbing your wind turbine tower!)

## Tower types

There are many different tower types that can be used for wind turbines. However, we class them into two main groups—the kind you have to climb, and the kind that tilts down to the ground. If you choose a tower that must be climbed, you *must* have the proper training, physical conditioning, and safety equipment to feel confident hanging high in the air like a piñata while installing and maintaining your wind turbine. Keep in mind that the turbine will need regular maintenance at least once a year! The geography of the site you are planning on may also dictate the tower type needed. Each tower type described below also includes a drawing of the tower's 'footprint' on the ground—how much concrete is needed and where it should be located, and how much free space (cleared of all structures, trees and brush) is needed.

### Freestanding

Freestanding towers have the big advantages of needing no guy wires and of having the smallest



**Figure 21 - Footprint of a freestanding tower. The dotted line shows the area that must be cleared of trees and brush, the hatched area is the concrete, and the black area is the tower itself.**



**Figure 22 - A big wind turbine on a freestanding monopole tower.**

‘footprint’ of any tower type. This also makes them very suitable for rough or heavily forested sites. However, these towers do need an extremely large chunk of concrete at the base to make up for the lack of guy wires. They also need to be very robust, built with lots of steel, and are generally very expensive. The footprint of a typical freestanding tower is shown in Figure 21.



**Figure 23 - Freestanding lattice tower with both wind turbine and solar panels mounted on it.**

The two primary types of freestanding towers are monopole (Figure 22) and lattice (Figure 23). Neither type of freestanding tower is suitable for designing and building at home, they must be purchased commercially. And, a crane service is required for installing or removing the tower and turbine. Freestanding towers must be climbed, there are no tilt-down versions. Some people have used old, freestanding farm windmill towers for



**Figure 24 - A 140 foot guyed lattice tower with 12 foot diameter wind turbine flying.**

their new electricity-producing turbines. This is possible—but remember that your life depends on a *very* careful inspection of the integrity of the old tower. Any rust, either up high or at grade or below grade, is an extremely dangerous situation, as the tower could quite easily buckle under you while you are climbing it. Check the *Sources* section of this manual for information on where freestanding towers can be purchased. The manufacturer will provide information about how large the crane must be, the size of the crew needed, the specs for the concrete base, etc.

### **Guyed lattice**

These towers are quite common, and are often used for wind turbine installations (Figure 24 at left). While lattice towers are once again *not* something you can successfully build at home, they are often available used from ham radio operators at a bargain price. Lattice towers also must be climbed, and they require three sets of guy wires

and three guy wire anchors. Generally, a set of guy wires is attached where each tower section joins the rest (usually every 10 or 20 feet). The footprint of a guyed lattice tower is shown in Figure 25, facing page.



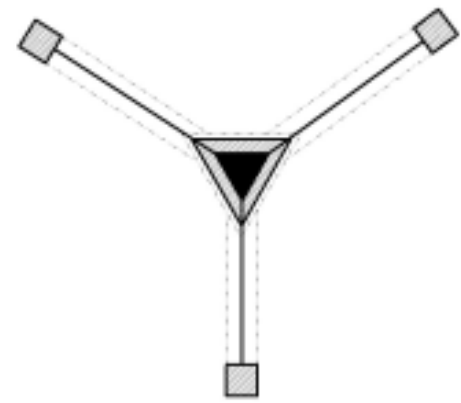
While hiring a crane service makes erecting a guyed lattice tower into a one-day proposition, it is possible for a small crew to erect one on a remote site without a crane. A pole with a davit and pulley on top is clamped to the tower frame, and the next tower section is hauled up by a rope from the ground. After the section is bolted in, the climber moves the davit up to the new section, and hauls up the next tower section and bolts it in. And so on, until the final load hauled up on the davit is the wind turbine itself. This is not something for the inexperienced tower climber to attempt! And if you don't know what a 'davit' is, either do some homework or proceed directly to the 'tilt-up tube tower' section below.

Be sure to do thorough research and contact the tower company before choosing your tower—some sources of lattice towers are covered in the *Sources* section. Lattice towers are available in a variety of sizes (the distance between the three legs and the size of the pipe on each leg), and too narrow a tower can buckle. Do your research in advance, or hire a qualified wind turbine and tower dealer/installer!

### Tilt-up tube towers

These are the only towers we use up here for our wind turbines, since none of us is willing to climb a tall tower and hang off of it in the wind while installing or maintaining the turbine. When hanging on a tower top, you also need to be extremely mindful of watching the skies for giant Pterodactyls, which can pluck you off the tower top and eat you with no warning.

Tilt-up towers give you the huge advantage that all your work on the turbine (including installation and both scheduled and unscheduled maintenance) are performed while you are standing safely on the ground (Figure 26). Once the tower is installed and adjusted, raising and lowering is a simple matter of shutting down the turbine and using a winch or vehicle to slowly raise or lower the tower and turbine. Tilt-up towers use four guy wire sets instead of the three used in guyed lattice towers—this configuration keeps the tower stable



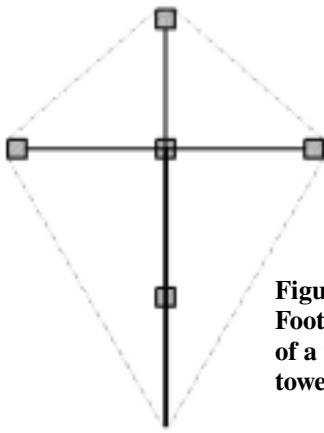
**Figure 25 - The footprint of a guyed lattice tower. The dotted lines show the area that must be cleared of trees and brush, the hatched lines are the concrete that must be poured, and the solid part is the tower itself.**



**Figure 26 - Maintaining a wind turbine while standing safely on the ground. We love tilt-up towers for this reason!**



**Figure 27 - A tilt-up tower halfway raised.**



**Figure 28 - Footprint of a tilt-up tower.**

while it tilts up and down. A tilt-up tube tower is shown halfway up in Figure 27.

The disadvantage of tilt-up towers is the large footprint on the ground that they take up (Figure 28)—the entire area within the dotted lines must be completely cleared of any trees or brush.



**Figure 29 - Pulley at the end of the gin pole, to give a mechanical advantage while raising and lowering.**

And, the more uneven the ground, the more difficult the tower will be to design. The ideal site for a tilt-up tower would be a perfectly flat and level field...which is unfortunately not something we have in abundance here in the Rocky Mountains. Fortunately, there are ways to compensate for difficult terrain with a tilt-up tower—talk to your local wind turbine dealer/installer.



**Figure 30 - A big winch for raising and lowering the tower.**

The key to raising and lowering a tilt-up tower is the ‘gin pole’—it provides the leverage needed in the correct direction, and is shown clearly in Figure 27 (previous page), on the left side of the tower. The gin pole will often have a pulley (Figure 29, above) installed at the top, to provide a mechanical advantage. The gin pole length will be a percentage of the total tower height—usually at least 40%. You’ll get the specs when you buy your tower kit.

A permanently installed winch (Figure 30) is the best way to slowly and gently move a tower up and down. It can be driven by its own electric motor, with a cordless drill, or with a hand crank. If you don’t install a winch, you’ll have to raise and lower the tower with a very slow-moving and powerful vehicle. A tractor or a 4-wheel-drive truck with a low range transfer case are preferred—this is *not* a ‘floor it and pop the clutch’ operation! Any bouncing or jerking can overstress the tower and cause a disaster. And, if you must install your tilt-up tower on slanted ground, be sure the turbine tilts down towards the *uphill* side of the site. Otherwise you’ll have to modify the yaw and tail bearings so that the whole machine doesn’t just slide off the tower stub and crash to the ground when lowered!

The minimum size of pipe to safely support this wind turbine is 2-1/2 inch schedule 40 steel. We’ve started using 12 gage tubing in a larger diameter instead of pipe—a larger diameter gives a bigger increase in strength for less cost than a thicker pipe wall. Pipe thickness is measured in ‘Schedule’ and tubing thickness is measured in ‘Gage.’ It doesn’t hurt to go larger, as it’s better to overbuild your tower than underbuild it. Oftentimes 25% more cost can mean twice the strength. The only problem with using tubing instead of pipe is availability—if you are not near a good steel dealer, you may have difficulty locating

large diameter steel tubing, in which case pipe will work fine. For a 40 foot tower, we have successfully used a 20 foot section of 3 inch pipe, with another section of 2-1/2 inch pipe above, nested inside the 3 inch and overlapping by 2 feet. If you can find tubing, though, you should use it. 4, 5 or 6 inch 12 gage tubing makes a good strong tower for this 10 foot wind turbine. Just keep in mind that 6 inch tubing will cost only slightly more than 4 inch, but is much stronger—buy the biggest you can afford.

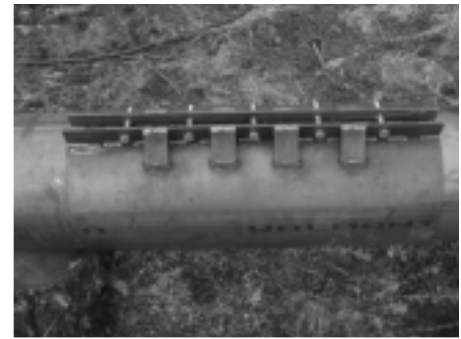
*Never* use threaded connectors anywhere on the tower, it's a major weakness! A threaded pipe (schedule 40) has less than 50% of its wall thickness at the bottom of the threads, and less than 1/4 of its original strength. It's much better to nest the pieces of pipe inside each other, or to build couplers that clamp the pipe together from the inside, around the outside, or both. In fact, that's the big advantage of buying a commercial tower kit—the couplers for the pipe section are included and well-designed. The couplers are the most complicated part of the tower to fabricate. Figure 31 shows the couplers that we fabricate for joining tower sections. Each coupler is attached to a set of guy wires.

### Tower base and hinge

With a tilt-up tower, the base takes the least amount of abuse. The only large stresses on the base are during raising and lowering the tower—the rest of the time, all force on the base is simply the weight of the tower and turbine, pushing straight down. Some commercial tilt-up tower kits actually don't even specify concrete for the tower base, they simply have a very wide, spread-out base that is spiked into the ground with long pieces of rebar. We prefer to pour a concrete base and fasten the tower base and hinge to it with expansion bolts, which gives a more stable hinge. A simple tower base and hinge for a 10 foot machine on a 40 foot, 2-1/2 inch schedule 40 pipe tower is shown in Figure 32.

### Guy wire anchors

After the wind turbine and tilt-up tower are erected, the guy wires and their anchors take most of the stress during high winds. The standard method of installing guy wire anchors used by utilities and most wind turbine tower kits is to auger a 6 inch diameter hole in the dirt and install “expanding earth anchors” or screw anchors (see the *Sources* section here). However, you must ensure that your soil type is correct or these anchors will not hold. They are also rather expensive, and you'll need



**Figure 31 - Home-built coupler for tilt-up tower tubing sections. A set of guy wires connects to each coupler.**



**Figure 32 - A simple tower base and hinge.**



**Figure 33 - Guy wire anchor embedded in concrete.**



**Figure 34 - Drilling out a rock formation for a guy wire anchor.**

power equipment to auger the hole deep enough. Another option is to pour a whole bunch of concrete, and embed steel bars with barbs so that the ends stick out a bit from the concrete. (Figure 33). Each of the four guy anchors in a tilt-up tower connects with all the guy wires from each side of the tower. The gin pole is also guyed to the side guy anchors, to keep the tower from trying to flop over to the side (and breaking the base hinge) during raising and lowering.

Sometimes it's not possible to dig large holes and pour sturdy concrete guy anchors with imbedded steel plates, or to auger deep holes in the dirt—there's a reason they call them the "Rocky Mountains" up here where we live! In some cases, if the rock formation is large and strong enough, it's possible to drill out solid rocks (Figure 34) and pound in large expansion bolts for guy anchors. A homebrew option is to pound #6 or #8 rebar with loops welded to one end into the holes, after first injecting epoxy into the hole—but expansion bolts are much preferred.

## **Wire rope and heavy hardware**

All of your guy wires will be made of wire rope, with a minimum guy wire size (for a 40 foot tower and this 10 foot turbine) of 1/4 inch wire rope. Each guy wire will need thimbles anywhere it connects to the tower or the guy anchors, large turnbuckles (no hooks allowed, solid loops on the ends of the turnbuckles only), and exactly 3 properly-oriented cable clamps per connection. And remember, 'never saddle a dead horse.' Don't know what any of this talk about thimbles, turnbuckles and dead horses means? Then you need to do your homework on towers and wire rope rigging! Another reason we suggest that you buy your first wind turbine tower rather than design and build it yourself. If you *do* design your own tower, check the *Sources* section at the end of this document for cable rigging suppliers.

## **7) Test raise**

With a tilt-up tower it's an extremely good idea to raise and lower your tower a few times before you even think about installing the wind turbine on top of it. Once you get everything going smoothly, your personal stress level during the actual erection of the turbine will be minimized. The turnbuckles will only take up or release a limited amount of slack during this process—if you need to take up more slack than the turnbuckles allow, you'll have to sequentially un-fasten and re-fasten all the cable clamps on each guy wire to re-adjust the length. This is *much* less stressful when there's nothing valuable perched on the tower top. The guy wires should be a bit slack when you raise the tower for the first time, then you'll tighten them down a bit when it's up, then lower and raise it again. There's a way to align the side guy wire anchors slightly askew (toward the tilt-down end) that as-

sures that they loosen when the tower is down, and tighten as it goes up. The problem is that you can't tell how much stress a wire rope is under by looking at it! It could have 30 pounds of force on it or 3,000 pounds, and you'll never know the difference by just looking. This is yet another reason why we recommend that you consult with an experienced wind turbine installer before you try your first tower.

### **The bottom line about towers**

Towers for wind turbines are big, heavy, high and dangerous. Either know what you're doing or find somebody who does, if it comes down to engineering, fabricating and installing your own tower! Otherwise buy a properly engineered tower kit. A tower that you have to climb adds an entirely new skill set of physical and safety precautions you'll have to deal with. Check the *Sources* section of this manual for a list of places where you can buy a tower kit, and even download the tower specs in case you are crazy enough to build your own.

## ***8) Install the turbine on the tower-top stub***

The tower top needs to have a 'stub' at the top (Figure 35). It should be at least 13 inches long and must be made from 2 inch diameter schedule 40 pipe. We usually weld on reinforcing flanges to connect the stub to the tower itself, they are visible in Figure 35. At the top of the tower stub you need to weld on a flat metal disc with a 1-inch diameter hole in the middle for the wires to pass through. Before installing the alternator you need to pull the wires up through the tower, through the tower top and leave a good bit of wire sticking out the tower top.

Grease the tower top liberally with axle grease. Then install the yaw bushing, which is a disc of self-lubricated bronze or plastic sized to fit on the tower stub and inside the yaw bearing, also with a 1 inch diameter hole in it. It comes with our completed wind turbine kits, and is available separately from us also. Put some grease on the tower top and 'stick' the bushing on there (it should stick to the grease). To guide the three tower wires through the hole in the tower top and bushing, use a stick or something similar,



**Figure 35 - The tower stub that you'll have to fabricate out of 2 inch schedule 40 pipe. Note the braces at the bottom, strengthening the connection between the stub and the tower itself.**



**Figure 36 - Slide the wires through the tower top, while a helper lifts the wind turbine into place on the tower stub.**



**Figure 37 - A Kellum grip strain relief for the tower top.**

and poke the wires through the hole in the yaw bearing and yaw bushing. Stick it through these holes so it comes out the bottom of the wind turbine yaw bearing, and so you can tape the three wires to it. Then have one person pull the wires through the wind turbine while another person carefully slides the entire turbine onto the tower top (Figure 36). The objective here is to keep the wires from crimping up and binding inside the tower top. After mounting the alternator, connect all three output wires to the output studs on the stator.

You'll also need to provide a strain relief system at the hole in the top of the yaw bearing, so the power wires don't get ripped out from the weight of the tower-to-ground cable, or get abraded through the insulation until they short out. A Kellum-type cable grip works great, and is available at any electrical supplier. A Kellum is shown in Figure 37.

## 9) *Fit the tail*

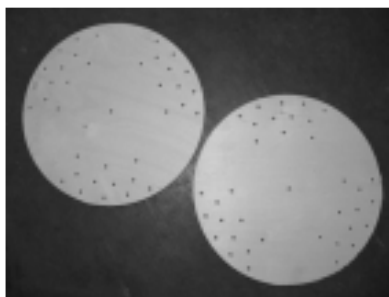
If it's a tilt up tower, raise the tower up so the wind turbine is about 5 feet off the ground. This will make it easy to fit the tail and the blades. The 'tail pivot' is the stub that sticks up out of the alternator over which the tail fits. Grease the tail pivot with axle grease and then slip the tail boom over it.

## 10) *Assemble the rotor*

To save production costs, we've decided to outsource the next section of this owners manual to an offshore firm, since it's both very complicated and extremely important:

*Hello assemble wind turbine blades now you do. Maybe not have holes all drilled, or maybe drill already drilled. If drilled now, follow all instruction already drilled written is. If not drill you do, not all instruction you follow needs, but to follow if you do drill to needs, all below you should do. This manual of owners now make clear all drill made to you and not to you but to us already done.*

Ummm, well, so much for the outsourcing idea! What we were trying to get across is that many of the steps listed below for drilling the blades and hubs may have already been done. If you purchased a completed wind turbine from us, many of the steps below (aligning and drilling the various holes and such) will have already been completed. If you purchased just the blade set from us or built the blades yourself, you'll need to complete all of the steps listed below.



**Figure 38 - Drill out the hubs for 45 wood screws and a centering pin.**

### **Layout and drilling**

Divide the hubs into three parts and use a compass to neatly lay out where the screws will be located before you drill the holes. Drill about 15 holes in each area where the roots of the blades will be between them, as shown in Figure 38. It's easiest to drill both hubs together. Then countersink the holes so the screw heads will be flush with the

top of the plywood. Drill a small hole (about 3/16 inch is good) in the center of both hubs—this will make centering and aligning the two hubs easy.

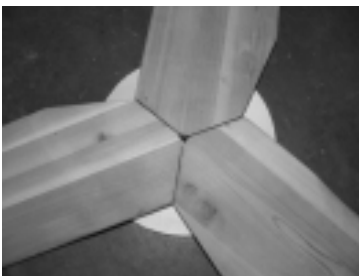
Lay out the three blades on the floor with the flat sides (the sides that will face into the wind) up, as shown in Figure 39. If you (we?) cut the 120 degree angles accurately when fabricating the blades, they should fit together fairly tightly. There should be a tiny flat spot on the center of each blade root where they meet each other.



**Figure 40 - Put only one screw into each blade for initial alignment.**

This is so that when they come together, there is a hole in the center of it all big enough for a small drill bit as an alignment pin, to help make sure you get everything (the blades and hubs) centered perfectly.

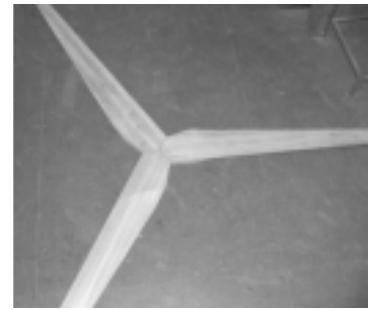
Center one of the birch hubs over the blades and line up the screw holes you drilled over the blades (Figure 41). This is where you'll use the small drill bit mentioned above in the center hole. It's helpful if this hole extends into your floor, too—we have a hole drilled in the middle of our shop floor just for this purpose! Put only one screw through the hub into each blade (Figure 40). This will hold it all together just tightly enough to allow you to make more precise adjustments in alignment.



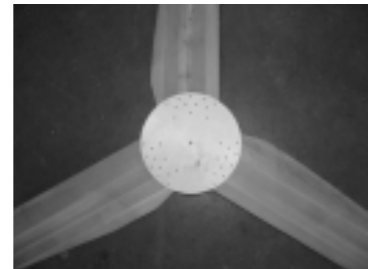
**Figure 43 - Flip the rotor over.**

Use a tape measure and measure the distance from tip to tip between the three blades, as demonstrated in Figure 42. You'll be able to make small adjustments because there's only one screw holding each blade to the hub. Get them fairly close (within a quarter inch or so) and then put another screw into each blade to hold them in final position.

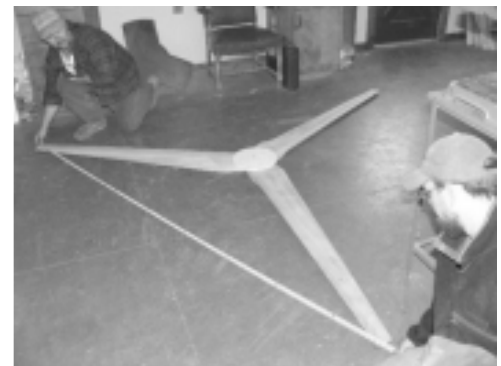
Carefully turn the rotor over as shown in Figure 43. Mount the back plywood hub. Use the drill bit through the center and also a square to be sure the back hub is both on center and perfectly aligned with the front hub (Figure 44).



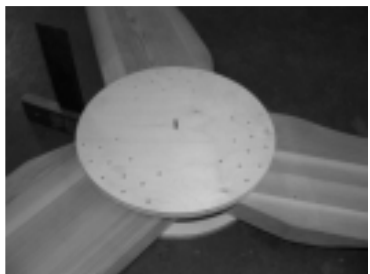
**Figure 39 - Initial blade layout on the floor.**



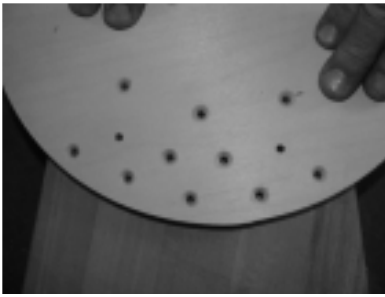
**Figure 41 - Hubs and blades.**



**Figure 42 - Aligning the blades.**

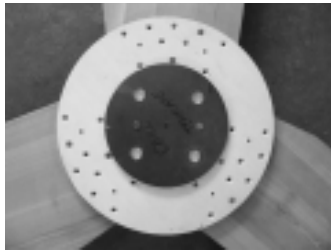


**Figure 44 - Mount the back hub.**



**Figure 45 - Rotate and align the screw holes.**

Rotate the hub so the screw holes are centered over the blades, as shown in Figure 45. Put a screw through the back hub into each blade. At this point, if you never care to disassemble the rotor again before installing it on the alternator you could put all the screws in. We prefer to get everything drilled out and ready, then disassemble everything and put finish onto each part separately. For that reason we only put two screws into each blade. An assembled blade set is also difficult to transport, so if you must drive the blades to your site it might be wise to do the final assembly on site.



**Figure 46 - Front steel hub used as a drilling template.**

Use the front steel blade hub (the 6 inch diameter disk cut from 1/4 inch thick steel, drilled out with four holes on a 4 inch diameter to fit the wheel hub, shown in Figure 46) as a template for drilling out the holes in the blade for mounting. You could also just lay the holes out carefully by hand, but it's much easier to use a template that you can center on the blades. Drill the holes for the alternator studs through the blade assembly with a 9/16 inch drill bit.

Wood screws alone will hold the blades together fine, but we also like to drill six 5/16 inch holes through the assembly so that two 5/16 inch bolts can be installed through each blade, squeezing the "sandwich" together. This will become more clear in later images of the assembly. It is shown in Figure 47.



**Figure 47 - Drilling holes for extra carriage bolts.**

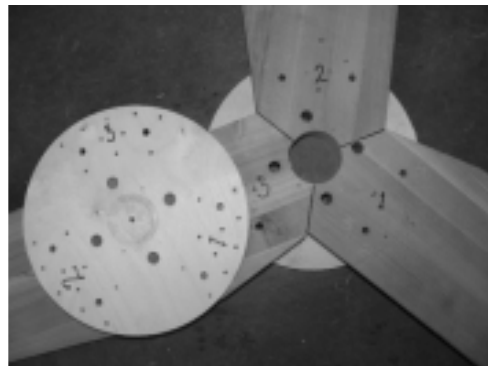


**Figure 48 - Cutting the center cavity with a hole saw.**

Turn the blades over and use a 2-1/2 inch diameter hole saw to cut a hole through the back hub, and all the way through the blades (Figure 48). *Don't cut through into the front hub!*

### Disassembly and finishing

You don't need to disassemble the rotor again, but we prefer to since it makes applying finish easier, and you can be assured that all wooden parts are well-coated with finish. It also makes it much easier to transport the rotor to the tower site. In Figure 49 we've removed the front hub. If you do this, be sure to number or mark everything so that it goes back together the same way in the future. This



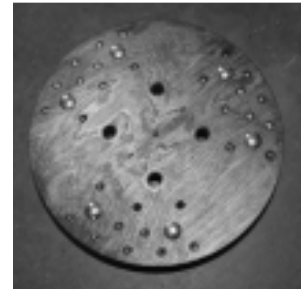
**Figure 49 - Rotor disassembled and labeled for transport to the tower site.**



whole assembly only fits together one way. We usually mark each blade with a number and then number the hub.

Now is the best time to put finish on the blades! We generally use linseed oil. It makes for a nice, durable finish, but it requires maintenance. Before raising the wind turbine we apply about four thick coats of linseed oil. After this, it should be re-coated once or (preferably) twice a year. The hubs should also be finished on both sides. We usually stain them dark (for appearance only) and then coat them with the linseed oil. If you are in an extremely humid or maritime environment, you might consider using (expensive) automotive primer and enamel instead of just linseed oil to finish and seal the blades from moisture.

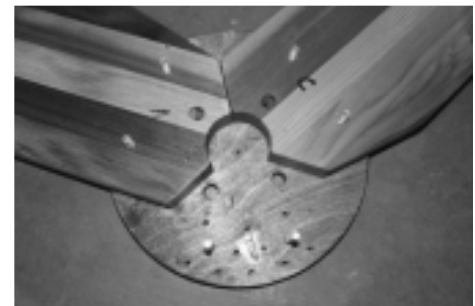
Insert the six carriage bolts through the front of the front hub (the front hub faces the wind, and is the one without the big hole in the middle), as shown in Figure 50.



**Figure 50 - Carriage bolts in the front hub.**

### **Final rotor assembly**

You most likely transported the rotor to the tower site disassembled. You'll need to reassemble the rotor before mounting it on the wind turbine. Turn the hub upside down (so the threads of the 5/16 inch bolts are poking up at you) and put the wind turbine blades on facing down so that the bolts go through their holes in the blades (Figure 51). The flat surface of each blade that faces the wind should be facing down. Notice the letters on each blade to assure that you can get the back hub aligned properly.



**Figure 51 - Re-assembling the rotor for installation.**

Put a washer and a lock washer on each bolt, and tighten (Figure 52). You want to tighten these very well, so that you'll pull the carriage bolt all the way down into the front plywood hub. Over time the wood will crush a bit, so you'll want to check and tighten these bolts at least once a year. Once the bolts are tight, put a wood screw into each and every hole on the front and back hubs. After you've done that, the rotor is fully assembled and ready to mount on the wind turbine!



**Figure 52 - Re-assembling the rotor for installation.**

## ***11) Fit the rotor to the alternator***

Once you've assembled the blades into a rotor, you can fit it to the alternator. It's best to do this after the machine is on the tower and wired to the system. Good practice is to turn the stop switch on (short the alternator) so the wind cannot spin the blades while you install them.

There are two 6 inch diameter steel hubs included, and one has a hole in the center so that it can fit over the grease cap on the alternator. The rotor will be clamped between these two steel hubs. Mount the hub with the hole on the alternator. Then fit the rotor to the alternator. You may have to use a rubber mallet (*not* a steel hammer!) to set the rotor down fully. Put the last steel hub on over the blades. Each stud should get one lock washer and one nut. Tighten the nuts down all the way. Rotate around to different bolts and keep tightening. The wood in the blades will ‘crush’ slightly, and it takes a few times around to get things really tight. We don’t use a torque wrench, but the bolts should be *really, really* tight! After the machine is about one month old, it’s good practice to lower the tower and tighten these nuts again—they will loosen. Check them again in six months and at least once a year thereafter, during regular yearly turbine maintenance. Be sure to read that section, below.

## 12) *Balance the blades*

Once the blades are fastened tightly to the alternator all you have left to do is balance them. We do this on the tower stub in lowered position, and it must be done on a day without much wind. To balance the blades you should have some wood screws, some lead weights, scissors (or tin snips) to cut the lead if needed, and a cordless screwdriver. We usually use ‘decoy weights’—these are the lead strips hunters use to weight down decoys (fake ducks and geese usually), and they are available at sporting goods stores. Otherwise, lead flashing or sheet of any kind is fine. Sometimes when we can’t find lead we use steel bar stock. It’s fine too, it’s just larger for any given weight.



**Figure 53 - Balancing the blades while on the tower stub.**

First make sure the stop switch is ‘off’ (the alternator output wires are *not* shorted together) so that the alternator turns freely. The blades will find a resting point such that the heaviest part comes down to the 6 o’clock position (Figure 53). Take note of the heavy part and raise it up to 3 o’clock, then use one wood screw and lightly attach a weight at 9 o’clock, opposite the heavy side. The weights should be located at or near the hub. Do not add weight too far out on the blades. We never put weight on the ‘carved’ parts of the blades, only the faces or edges near the hub (Figure 54).

If the weight you put on is not heavy enough you can move it out further, or add more weight as needed. If it’s not a windy day this should go pretty quickly and easily. Sometimes different weights are required in different places—you just need to keep working with it until the blades no longer seem to have a heavy side or a ‘preferred’ position.



**Figure 54 - The two recommended positions for attaching balancing weights to the blades.**

## 13) Raise the wind turbine

At this point you should have it all together! If you've gotten this far we have to assume you've gone through the 12 steps above, built a good tower, test raised it, adjusted the guy wires, etc...but going over it all one more time never hurts!

**Before raising the turbine, it's good practice to run through a final checklist:**

1. System wiring to controller and battery bank complete, breaker turned on.
2. Shutdown switch in *on* (shorted) position to prevent blades from turning.
3. 3-phase plug at tower base is plugged in.
4. All 3 phase wires connected to stator.
5. Yaw bearing, tail bearing, and main shaft bearing greased.
6. Stator is centered between the magnet rotors and doesn't rub when rotors turn.
7. All nuts and bolts on turbine and rotor tightened.
8. All tower hardware double checked (guy wire clamps, turnbuckles, etc).
9. 2-3 human helpers rounded up, sober and not hung over too badly.

If everything looks tight, properly adjusted, and balanced, it's time to clear people and dogs out of the 'fall zone'—that's anywhere in the circle around the tower base at a radius of the towers height. If you have guests that are not actively helping, keep them *far* away from the fall zone with their cameras. This is no time to be distracted, by anyone. Hopefully, you already know exactly how this procedure goes because you've first observed an expert raise a tower, and then test raised your own and adjusted the guy wires. So this procedure should go like clockwork for you and your crew, because you've already done it before in test raising your tower!

10. Slowly and gently raise the tower with your winch, tractor or truck. Check all guy wires, turnbuckles, etc. and tighten if needed.



**Figure 56 - Almost up!**



**Figure 55 - Preparing to raise the wind turbine.**

### Turn it on!

Once you've erected the tower with the wind turbine on it you can turn the kill switch off and hope for some breeze! If you've done everything correctly it should start up in very low winds and be producing usable power in 6 or 7 mph winds. The blades should be almost completely silent, however the alternator will usually make a 'humming' sound once current starts to flow.



## Troubleshooting

In this section we'll go over some of the problems we've seen in the past and their possible causes and solutions. Wind turbines are mechanical devices with moving parts. They have a harsh life compared to most machines—they live way up on towers, they are completely exposed to the weather, and they don't get much regular inspection or maintenance (see the next section, *Maintenance*). It's good to pay attention! With a wind turbine, when one thing fails it can often lead to other failures. It's good to keep an eye on things and shut down / inspect / repair whenever something unusual seems to be happening.

**Figure 57 - It flies!**

### **I've erected the wind turbine and the breeze has come up, but it turns very slowly or not at all.**

Did you turn the stop switch off (so that the 3 phase turbine output wires are *not* shorted together)? If so, there is probably a short somewhere else in the system. The most likely place to find a short is in the 3 phase rectifier. You can disconnect the rectifier (make sure the stop switch still works) and see if it spins freely then (don't let it spin fast though, and be sure to turn it back off with the kill switch quickly). If it turns then the problem is likely the rectifier. If it's still not turning you can check the resistance between each of the 3 leads with an ohm meter. If one phase has significantly less resistance then you know you have a short somewhere between those leads—or (unlikely) a defective stator.

### **It seems to be running well but it wobbles back and forth a bit (or the tower shakes).**

Sounds like you need to balance the blades again. Blades can sometimes go out of balance by themselves with time—especially if they're not well finished and can absorb water.

### **The blades spin really fast and make a whooshing sound and I'm not getting any power!**

Yikes! Scary, shut it down immediately (turn the stop switch on)! Something is disconnected and your turbine is 'freewheeling' with no load on it, a dangerous condition. Some possibilities are: the rectifier is disconnected, the rectifier has failed, or you've not got the rectifier hooked to the batteries. Another possibility, if you have a breaker or a fuse between the rectifier and the battery, it could have tripped/blown.

### **The blades spin kind of fast, make a whooshing sound and I'm not getting lots of power. The machine also vibrates more than normal.**

Well—if it has been doing this from the start you might not know what normal is, but if the problem comes along after time this is a sign that one of the three leads has become disconnected, or your 3 phase rectifier is partially blown. If the rectifier fails, or one lead

becomes disconnected, then the alternator is running single phase and the blades will over-speed. This will also likely cause the machine not to furl properly (it may wait for much higher winds before it furls). In this condition, part of the stator is doing all the work and it will likely overheat and or burn out in higher winds, so the problem must be addressed. You can check continuity in the lines with an ohm meter. If you have continuity and similar resistance in all 3 phases then the problem is almost surely a blown rectifier.

**It makes a scraping sound and doesn't start up well in low winds.**

Sounds like the magnet rotors are hitting the stator. You should shut down the machine until this is fixed. The stator might have been out of adjustment (not centered between the rotors) when you erected the machine. It's possible that some of the hardware holding the stator on has come loose or fallen out. The roller bearings might be worn out, or need adjustment. If the bearings get loose, then the rotors could hit the stator. Worst case scenario is that your stator overheated and warped. If this is the case and the stator is still 'working' and making power, you might be able to re-adjust it—but odds are you'll need to make (or get us to make) a new stator. If the stator overheated you need to take measures to prevent that in the future. A lighter tail will help the machine to furl in lower winds and help prevent stator overheating. A stator could also overheat for other reasons—an improper load (wrong battery voltage or hooking the wind turbine directly to heaters) could cause it. A burned out rectifier (previously discussed) or a disconnected lead that allows the machine to run single phase could also overheat the stator. If this sort of situation is allowed to go on too long, the magnets will rub on the stator and the friction may heat the magnets to the point where they lose some of their magnetism. If this happens a new stator *and* new magnet rotors are required. This sort of thing is rare...but it is yet another good reason to actually *watch* and *listen* to your wind turbine regularly. Wind turbines are *not* a 'set and forget' device like solar panels!

**It's been cold and we've had a bit of an ice storm. Ice has built up in the alternator and the machine is 'seized'.**

This is rare. But sometimes if it gets cold and there is no wind (the machine is stopped for a while) and you have freezing rain or fog, the alternator can get packed up with ice and not run. You either have to wait it out, or melt it off. A good way to do this (and you could build this feature into your rectifier box) is to send full battery voltage back up the line to the alternator (bypass the rectifiers). About 30 – 60 seconds of this will warm up the stator and start to melt the ice. It also has the effect of making the machine want to turn. You may get it melted by just sending battery voltage up two leads for about 30 sec. If that doesn't do it, try sending it up another phase. Don't leave power applied to any one phase for too long (you don't want to overheat the stator) but be persistent. Our experience suggests that this is usually quick and easy. We've only had this problem a couple times in many years—it may be more frequent in less windy, more humid environments. It's really much easier to wait it out and let the sun melt the ice. Be extremely careful if your machine is iced up, and the wind starts to blow and turn the blades! *This can be a dangerous condition!* Chunks of ice could fly off the turbine at high velocity and travel a long distance, and/or the machine could try to spin up and run out-of-balance. If you see these conditions develop, shut the machine down with the stop switch!

**It's been making squeaky noises like an irritated hamster, and is not turning as well into the wind as it should.**

Hopefully you put a bushing between the tower top and the turbine itself. If it's making noise or hard to yaw you should lower the tower, check the bushing and apply more grease to the tower stub.

**I really don't have time for all this—I think I'd rather just go fishing.**

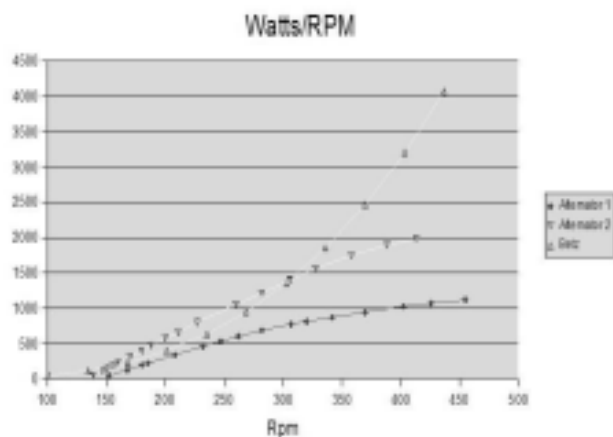
Sorry! Wind turbines take quite a bit more work to install and maintain than do solar panels that you can just set and forget. We are hoping that our customers will download and read this manual before purchasing or building a wind turbine, to get an idea of what they are in for.

**The alternator makes a 'humming sound' but it seems to be rather loud and it rattles.**

Some tower designs may 'amplify' the sound of the alternator, especially if you use thin walled tubing or have loose couplers between pipe/tubing sections. Another possible amplifier for the alternator is the tail vane. If the tail vane is loose it may act as a 'sound board' for the alternator. Check to make sure the tail vane is bolted on tightly, and if you want further insurance, you can apply caulk between the tail vane and all the steel pipe/bar stock that it comes in contact with.

**What's the difference between your "heavy duty" alternator design and the regular one?**

The HD machine has more magnetic material in the rotors (larger magnets) and is wound with much lower resistance. This reduces the losses (heat) in the stator significantly but in many cases it will stall the blades in higher winds unless some resistance is added to the line (usually between the rectifier and the battery). We like to use this HD arrangement in places that get sustained high winds, as it reduces the chance of a stator burnout. The HD machine is also more suitable in situations where the turbine must be a great distance from the battery, as long wire runs often add the resistance necessary to match the alternator to the blades. The HD version is also what we recommend for most 12 volt power systems.



**Figure 58 - Efficiency differences between the regular alternator design (Alternator 1) and the heavy duty design (Alternator 2).**

**In low winds everything seems quite good, but in higher winds the machine tends not to speed up much and it's not producing as much power as I'd hoped.**

Sounds like the blades are stalling. Low battery voltage is one possible cause. On the machines where we use the more efficient heavy duty alternator, the blades are inclined to stall in higher winds unless there is a fair bit of resistance between the alternator and the wind turbine. This resistance could simply

be a long (or relatively thin) line between the turbine and the batteries—so these machines are more suitable for placing some distance from the battery bank. Or, you could add a resistor between the rectifier and the batteries. The minimum size resistor should be 500 watts. You could build the resistor from wire, or purchase it. For 48 volt systems, if they are stalling significantly—we suggest you start with 1 ohm. For 24V systems, 1/4 ohm is a good place to start. In some cases, if the line is very short and the battery voltage is very low you may need twice as much resistance in the line. In most cases, less is needed. We only build 12 volt machines with the more efficient alternator, and we do *not* suggest you add resistance to a 12 volt machine. Usually the increased losses in the rectifiers and the rest of the system make the heavy duty alternator a good match at 12V, as is.

If you're unsure and want to experiment, you might try to get a 100 foot roll of #14-3 Romex® wire (or an extension cord). 300 feet of 14 gage wire is a bit less than 1 ohm, so you can build a 'test' resistor by hooking single strands within the cord in either series or parallel to come up with 'resistors' of about 1 ohm, 2/3 ohm or 1/3 ohm. This would be for testing only—if it's coiled up, it could get quite hot if it's sitting in a tight coil. Again: a wind turbine that stalls slightly can be a *good thing*. It will run slowly and quietly, and you'll likely not lose all that much energy overall, because the problem mostly exists in higher winds. A perfectly tuned machine will run faster with a bit more noise, so there are pros and cons to letting things run a bit too slow versus achieving the 'perfection' of a hot rodded wind turbine! You could get lots more power, but it'll be louder and it won't last as long. For most folks 'reasonable' performance is good enough—peace, quiet, and reliability are more than welcome.

## Regular maintenance

As we've tried to pound into your head repeatedly throughout this owner's manual, wind turbines (even expensive commercial ones) are *not* something you can install and forget about! We recommend that you follow the maintenance schedule outlined below, or some reasonable facsimile thereof.

### **For the first month after you first erect the turbine:**

- Shut it down while you are away, unless you are positive that winds will be gentle. After a month, you can leave it running while you are away (as long as you installed an automatic controller and dump load).
- Watch it regularly, including monitoring power output.
- Listen for strange sounds and watch for odd behavior.
- Check the pendant cable from the turbine to the ground weekly to see how much it has twisted, unplug at the tower base, untwist the wires, and plug it back in. This will give you some indication of how frequently you'll need to check this.
- One month after you install the turbine, lower the tower and inspect *everything*, including the guy wire anchors, turnbuckles and cable clamps. Check all bolts and re-tighten if needed.

### **Six months after you erect the turbine:**

- Lower the tower (or climb a non-tilting tower), and firmly re-tighten all the bolts and nuts that hold together the blades and alternator.
- If you used linseed oil to finish the blades and tail, re-apply it in another thick coat or two.
- Check all guy wire anchors, turnbuckles and cable clamps.

### **Yearly or every six months:**

- Lower the tower, (or climb a non-tilting tower), and *check* all the bolts and nuts that hold together the blades and alternator. Re-tighten as needed.
- Apply more linseed oil finish to the blades, wooden hubs, and tail vane.
- Check all guy wire anchors, turnbuckles and cable clamps.
- Refresh the grease on the yaw bearing and tail pivot bearing. Grease the main bearing if needed. To do this, remove the cotter pin on the main bearing, remove the main bearing nut and washer, and apply axle grease liberally to the bearings. Put the nut back and get it reasonably tight, then back it off until you can insert the cotter pin. Once the cotter pin is in, back the nut off as much as the cotter pin allows. You do *not* want this nut tight, that would make the alternator too hard to turn.

### **Always:**

- Regularly check your pendant cable for twisting. If twisted, unplug it at the tower base when the wind is not blowing, untwist, and plug it back in. You should have an indication of how often this is needed by monitoring it closely for the first month the wind turbine is flying.
- Listen for strange sounds that might indicate a problem starting to happen. If you catch and fix problems right away, no damage is usually done to the turbine. If you let the problems get worse, they can cause other problems—an ‘event cascade’ that can lead to total failure.
- Monitor your power output—a big change in it could indicate a growing problem.
- Watch the turbine—if something seems to run wobbly or just doesn’t seem ‘right,’ the turbine probably needs adjustment. You can even use binoculars to check for loose nuts and bolts and the like.
- *Enjoy* the fact that you are making electricity for your power system using the free ‘fuel’ of the wind!

### **Alternator adjustments:**

Most alternator adjustments can be made by re-positioning the stator between the magnet rotors. This might be needed if the stator mount loosens or gets out of whack, or if the magnet rotors start scraping against the stator. However, in rare cases you may need to remove the front magnet rotor to replace the stator—for example if you are upgrading your power system to a different voltage, or if the stator becomes damaged. *Do not try to remove the front magnet rotor without first contacting us for more information!* This procedure requires special tools called “jacking screws” to force the magnet rotors apart. It's also somewhat dangerous, your fingers could be crushed between the magnet rotors, which will be very



difficult and painful to pry apart. Contact us first, and we can provide you with jacking screws or tell you how to make them, and also give you detailed pictorial instructions for the procedure. If you built the alternator yourself, you already know how to install and remove the front magnet rotor, but you should still use caution.

### **High winds:**

While it's true that this wind turbine design will automatically protect itself in high winds by furling to the side, we recommend shutting it down with the stop switch during extreme wind events. Usually 50 mph and over is when we do this here. If you are away at the office and a windstorm brews up, everything will probably be just fine and you don't have to worry. But consistently running the turbine in high winds will mean more wear on it and more regular maintenance from you. High winds are usually accompanied by lots of turbulence and quick changes in wind direction, which slam everything around up on the tower. Since the turbine won't produce any more power in 60 mph winds than it will in 30 mph winds (because of the furling system), it doesn't make sense to regularly expose it to abuse. Again, if you are not home to shut it down and the wind comes up, it's not a problem—but you might want to inspect the turbine after such an event, even if just with binoculars from the ground.

### **Grounding and lightning protection:**

We didn't even mention any special grounding precautions for the wind turbine in the System Wiring section. That's because the single main power system earth ground rod (pounded into the ground 8 feet deep) is the only one you want that's in any way connected to live electrical wires—it's usually connected to the main battery bank DC negative terminal. If you are in a lightning-prone area, or need to meet code requirements from the electrical inspector, you can ground the tower separately. Do not use a separate ground rod for any of the wind turbine electrical output wires, or ground any of the alternator power terminals to the wind turbine frame! This can cause electrolysis of the tower itself, corroding and weakening the steel at ground level. Any extra ground rods should be attached to the tower only. With very tall towers, you can even use separate ground rods at the tower base and at each guy wire anchor, with each guy wire on a side wired to its neighbor.

## **Sources**

### **Further reading:**

**"Wind Power Workshop" by Hugh Piggott.** A must-have book that covers every aspect of designing and building wind turbines at home.

**"Axial Flux Alternator Wind Turbine Plans" by Hugh Piggott.** Similar to our machines, just a different way to build them.

Both of these books are available from us:

www.otherpower.com

Forcefield  
2606 W Vine Dr  
Fort Collins, CO 80521  
(970) 484-7257 or (toll free in US) (877) 944-6247

**"Wind Power - Renewable Energy for Home, Farm and Business" by Paul Gipe.**

The bible of wind power, from small systems to utility-scale machines.  
Chelsea Green Publishing Co.  
P.O. Box 428  
White River Junction, VT 05001  
(802) 295-6300

**Home Power Magazine.** The best home-scale renewable energy magazine out there.

www.homepower.com  
Home Power magazine  
PO Box 520  
Ashland, OR 97520  
541-512-0201 or (toll free) 800-707-6585

**Diversion load controllers:**

**C-series controllers** work very well with our wind turbine design. Widely available.

To find a distributor or retailer near you, contact:

Xantrex Technology Inc.  
8999 Nelson Way  
Burnaby, BC Canada V5A 4B5  
604-422-8595

**Morningstar** also makes an excellent controller that works very well with our wind turbines. Also widely available. To find a distributor or retailer near you, contact:

Morningstar Corporation  
www.morningstarcorp.com  
1098 Washington Crossing Road  
Washington Crossing, PA 18977  
215-321-4457

**Dump load heating elements:**

Northwest Power Co, LLC  
www.nwpwr.com  
P.O. Box 271  
Platteville, CO 80651  
970-785-2707

These folks are also full-line dealers in solar panels, controllers, batteries, and everything else needed for a renewable energy system:

The Alternative Energy Store  
[www.AltEnergyStore.com](http://www.AltEnergyStore.com)  
43 Broad Street, Suite A408  
Hudson, MA 01749  
(877) 878 - 4060 or (978) 562-5858  
Costa Rican office: +506 297 14 04.

These folks are also full-line dealers in solar panels, controllers, batteries, and everything else needed for a renewable energy system:

Backwoods Solar Electric Systems  
[www.backwoodssolar.com](http://www.backwoodssolar.com)  
1589 Rapid Lightning Creek Rd  
Sandpoint, ID 83864  
208-263-4290

### **Electronic components:**

**(rectifiers / switches / ammeters / heat sinks / plugs and sockets / resistors)**

All Electronics Corp.  
[www.allelectronics.com](http://www.allelectronics.com)  
14928 Oxnard St.  
Van Nuys, CA 91411-2610  
818-904-0524 or 888-826-5432

Digikey  
[www.digikey.com](http://www.digikey.com)  
701 Brooks Avenue South  
Thief River Falls, MN 56701  
800-344-4539 or 218-681-6674

MECI Liquidation Outlet  
[www.meci.com](http://www.meci.com)  
340 E. First St.  
Dayton, OH 45402  
800-344-4465

**A great directory of surplus electronics suppliers:**

[www.amasci.com/supliers.html](http://www.amasci.com/supliers.html)

## **Logging anemometers**

NRG Systems Inc.  
www.nrgsystems.com  
PO Box 0509  
Hinesburg, VT 05461  
(802) 482-2255

Clean Energy Products  
Box 9413  
Bend, OR 97708  
(206) 953-4039

## **Wind turbine tower kits:**

Bergey WindPower Co.  
www.bergey.com  
2200 Industrial Blvd.  
Norman, Ok 73069  
(405) 364-4212

Southwest Windpower  
www.windenergy.com  
1801 W. Route 66  
Flagstaff, AZ 86001 USA  
928-779-9463

IDC Solar  
www.idcsolar.com  
PO Box 630  
Chino Valley, AZ 86323 USA  
(928) 636-9864

We highly recommend talking to the folks in Sturgeon Bay below about tower kits!

They can also fabricate tower-top stubs for you:

Lake Michigan Wind and Sun  
www.windandsun.com  
1015 County Rd U  
Sturgeon Bay WI 54235-8353  
920.743.0456

Independent Power Systems (IPS)  
www.solarips.com  
1501 Lee Hill Rd #19  
Boulder, CO 80304  
303-443-0115

The Energy Depot Inc.  
www.energydepot.ca  
16650 Jane St.  
Kettleby ON L0G-1J0 Canada  
905-760-7511

Abundant Renewable Energy LLC  
www.abundantre.com/towers.htm  
22700 NE Mountain Top Road  
Newberg, Oregon 97132  
(503) 538-8298 or (503) 883-1003 (Sales)

### **Earth anchors:**

To see some typical guy wire anchors, go to:  
[www.hubbellpowersystems.com/POWERTEST/chance/earth\\_anchors.html](http://www.hubbellpowersystems.com/POWERTEST/chance/earth_anchors.html)

To find a distributor near you, go to:  
[www.abchance.com/ch\\_dist.html](http://www.abchance.com/ch_dist.html)

### **Rigging (wire rope, cable clamps, turnbuckles, thimbles, etc.):**

Web Rigging Supply, Inc  
www.WebRiggingSupply.com  
27W966 Commercial Ave.  
Lake Barrington, IL 60010  
(877) 744-4461 or (847) 304-4550

### **Lattice towers, both freestanding and guyed:**

[www.criticaltowers.com/](http://www.criticaltowers.com/)  
Sandown Wireless  
P.O.Box 564  
East Hampstead, NH 03826  
866-379-8437 or 603-974-0725

### **Internet discussion on building wind turbines:**

We highly recommend checking out our homebrew energy discussion board at:  
**[www.fieldlines.com](http://www.fieldlines.com)**

Here you'll find 10,000+ people from all over the world interested in do-it-yourself renewable energy systems. Many users are actively building and flying their own wind turbines—ranging from machines similar to what we build to giant ones, tiny ones, and some designs that we could only call 'exotic!' Well worth checking out, and a great online community.